



This is a digital copy of a book that was preserved for generations on library shelves before it was carefully scanned by Google as part of a project to make the world's books discoverable online.

It has survived long enough for the copyright to expire and the book to enter the public domain. A public domain book is one that was never subject to copyright or whose legal copyright term has expired. Whether a book is in the public domain may vary country to country. Public domain books are our gateways to the past, representing a wealth of history, culture and knowledge that's often difficult to discover.

Marks, notations and other marginalia present in the original volume will appear in this file - a reminder of this book's long journey from the publisher to a library and finally to you.

Usage guidelines

Google is proud to partner with libraries to digitize public domain materials and make them widely accessible. Public domain books belong to the public and we are merely their custodians. Nevertheless, this work is expensive, so in order to keep providing this resource, we have taken steps to prevent abuse by commercial parties, including placing technical restrictions on automated querying.

We also ask that you:

- + *Make non-commercial use of the files* We designed Google Book Search for use by individuals, and we request that you use these files for personal, non-commercial purposes.
- + *Refrain from automated querying* Do not send automated queries of any sort to Google's system: If you are conducting research on machine translation, optical character recognition or other areas where access to a large amount of text is helpful, please contact us. We encourage the use of public domain materials for these purposes and may be able to help.
- + *Maintain attribution* The Google "watermark" you see on each file is essential for informing people about this project and helping them find additional materials through Google Book Search. Please do not remove it.
- + *Keep it legal* Whatever your use, remember that you are responsible for ensuring that what you are doing is legal. Do not assume that just because we believe a book is in the public domain for users in the United States, that the work is also in the public domain for users in other countries. Whether a book is still in copyright varies from country to country, and we can't offer guidance on whether any specific use of any specific book is allowed. Please do not assume that a book's appearance in Google Book Search means it can be used in any manner anywhere in the world. Copyright infringement liability can be quite severe.

About Google Book Search

Google's mission is to organize the world's information and to make it universally accessible and useful. Google Book Search helps readers discover the world's books while helping authors and publishers reach new audiences. You can search through the full text of this book on the web at <http://books.google.com/>



US 41583.10 *



The gift of
William G. Stearns, Esq.
Steward of
Harvard College
recd 2 May, 1856

37-231
5

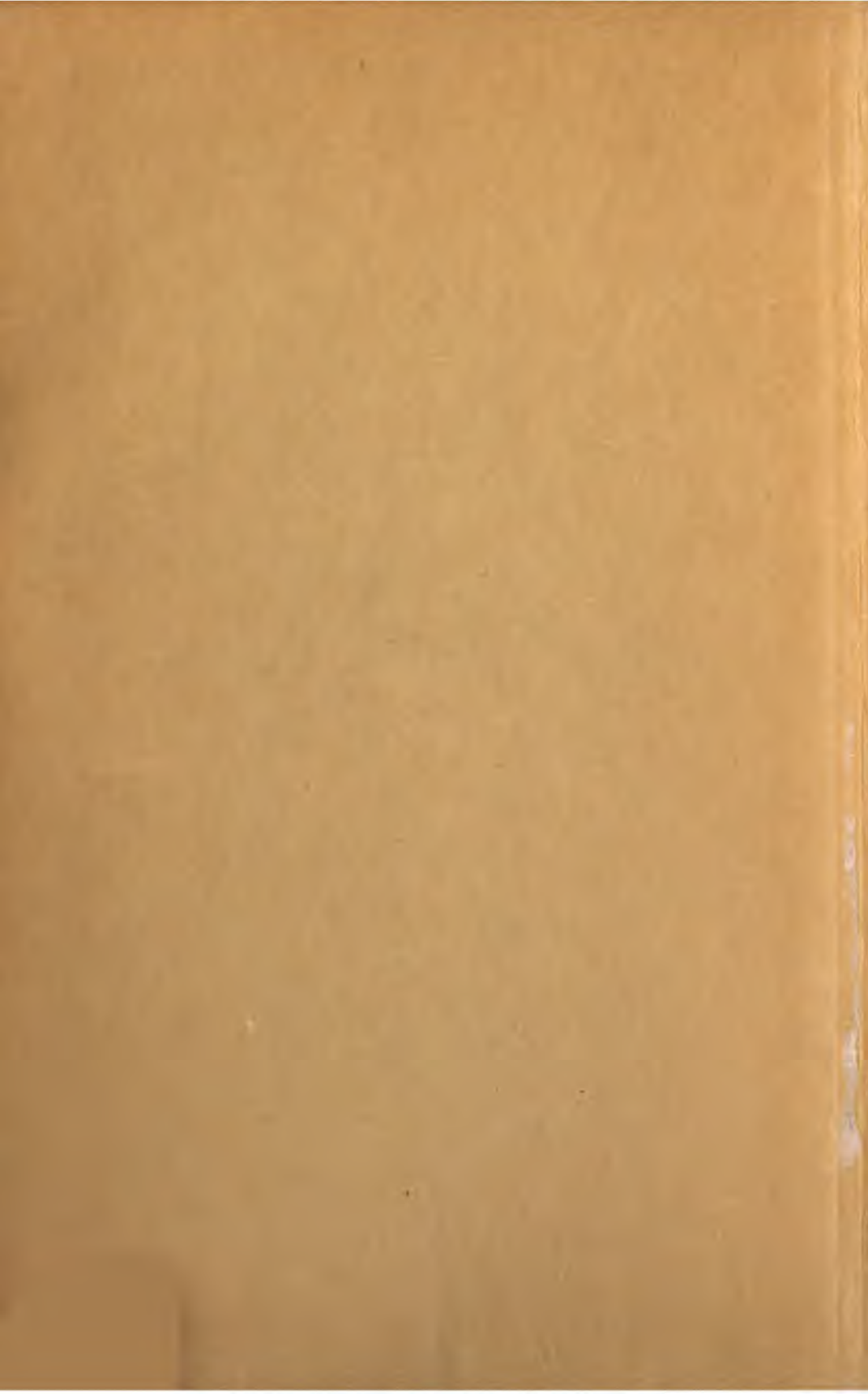

FAMILY MEMORIALS.

GENEALOGIES

OF THE

FAMILIES AND DESCENDANTS

OF THE

EARLY SETTLERS OF WATERTOWN,

MASSACHUSETTS,

INCLUDING

WALTHAM AND WESTON;

TO WHICH IS APPENDED

THE EARLY HISTORY OF THE TOWN.

WITH

ILLUSTRATIONS, MAPS, AND NOTES.

BY

HENRY BOND, M.D.

VOL. II.

ADDITIONS, CORRECTIONS, AND EARLY HISTORY.

BOSTON:

LITTLE, BROWN & COMPANY.

NEW YORK: JOHN WILEY, 351 BROADWAY.

PHILADELPHIA: LINDSAY & BLAKISTON.

CINCINNATI: H. W. DERBY.

1855.

~~10326.0~~

US 41583.10



Entered, according to Act of Congress, in the year 1855, by
HENRY BOND,
In the Clerk's Office of the District Court of the United States, for the Eastern
District of Pennsylvania.

PHILADELPHIA:
PRINTED BY C. SHERMAN AND SON,
19 St. James Street.

137-23

CONTENTS OF VOL. II.

	PAGE
1. Additions and Corrections to the Genealogies in the First Volume,	673
2. APPENDIX I. The Early History of the Town,	977
3. APPENDIX II. A List of Authors quoted or consulted,	1077
4. APPENDIX III. The Lawrence Pedigree,	1080
5. APPENDIX IV. The Early Topography of the Town. Illustrated by a Map,	1082
1st. Map. Illustrating the Relative Position and Boundaries,	985
2d Map. Illustrating the Early Allotments and Topography,	1094

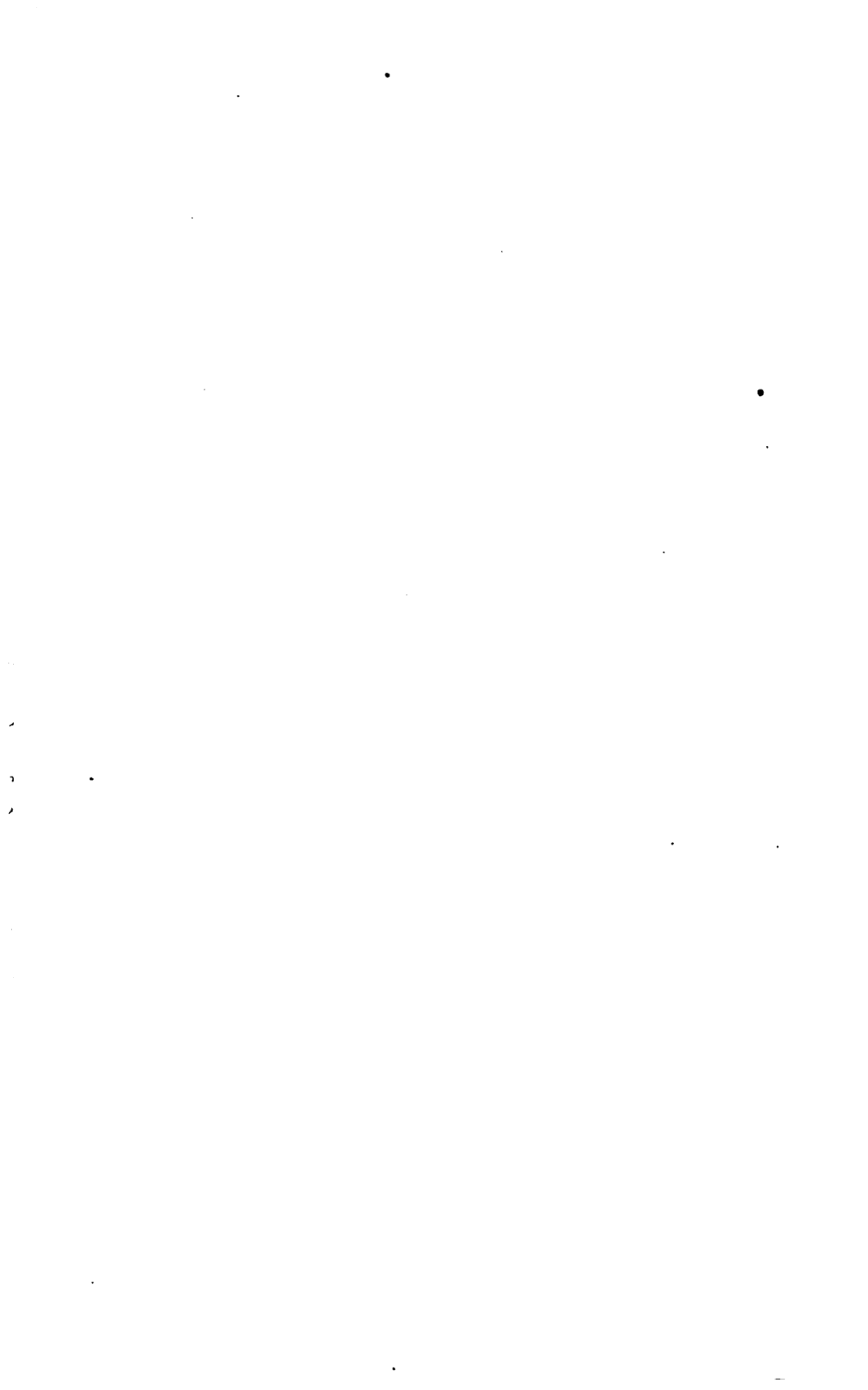

PART II.

ADDITIONS AND CORRECTIONS.

N.B. THE p. (page) with a number annexed, in the left margin, refers to a page in the preceding part; and a number in brackets [] in the same margin, refers to the ordinal number in the margin of the page referred to.

p. 1. **ABBOTT**.—JOHN ABBOTT, b. Aug. 26, 1662, son of George and Sarah (Farnum) Abbott, of Andover), m. JEMIMA —, and settled in Sudbury, about 1696. Chil., b. in Sud., 1. *Jemima*, b. Oct. 10, 1699, m. in Wat. Dec. 12, 1717, *Nathaniel Norcross*. [32.] 2. *John*, b. Oct. 3, 1701, m. in Lex. Oct. 18, 1721, *Elizabeth Phipps*, of Lex. [He, "of Wat.," settled in Connecticut]. 3. *Sarah*, b. Sept. 10, 1704, m. in Wat., Mar. 19, 1723-4, *Nathaniel Williams*, of Camb.; 4. *Mary*, m. — *Wheeler*; 5. *Hannah*, b. 1710, m. in Wat., May 6, 1729, *John Cady* of Tolland, Conn. [Cady, 5, in Part II.] It was probably their dr. *Hannah Cady*, who m. in Tolland, *William Shurtleff*. [See T. Hammond, 148, in Part II.] JOHN ABBOTT, millwright of Wat., was appointed on a committee for building a bridge over Charles River, in Jan. 1713-14. He owned or occupied the land between Mill Creek and the river. He d. in Wat., Mar. 24, 1717-18, aged 57 years, and his widow m. previous to 1721, *John Beeks*. The will of *Jemima Beeks*, dated May 28, 1747 [wit. by *John Coolidge*, *Sarah Briant*, and *Sarah Cotting*, and presented for proof Mar. 18, 1754, by *Daniel Livermore*], mentions dr. *Jemima Norcross*; dr. *Hannah Cadee*; and chil. of her dr. *Mary Wheeler*, d. *Mrs. Beeks* d. Mar. 4, 1754. [See *Beeks*, in Part II.]

ADAMS.—It is not improbable that GEORGE ADAMS, of Watertown, was a nephew of Henry Adams, of Braintree, and a brother of John Adams, of Cambridge [See *General Reg. VII.*, p. 40. And see *Camb. Church Gathering*, p. 62]. *George Adams*, with wife and 5 children, were living in Wat. in Jan. 1660-1, in indigence.

[7.] *Judith Adams*, from Lincoln, living with Dr. Adams, of Waltham, was warned [against settlement] Dec. 4, 1758.

p. 2. [32.] *George Adams* m. in Newton, 1758, *Abigail Prentice*, dr. of *Edward* and *Abigail* (Burrige) P.

[35.] *Benjamin Adams*, of Lex., adm. to *Waltham Church*, Mar. 21, 1724-5.

[38.] *Samson Adams* and wife *Mary* had dr. *Abigail*, b. in *Woburn*, Jan. 7, 1757.

p. 3. [49.] *Abigail Adams*, admitted f. c. in *Waltham*, Dec. 29, 1723.

[55.] *Lieut. Roger Adams*, of *Newton*, m. *Hepzibah Russell*, of *Wat.* [For his parentage, and the m. of his children, see *Jackson*, *Hist. Newton*, pp. 231 and 232. See there also, the parentage and family of *Smith Adams*.]

[56.] *Smith Adams*, son of *Joseph* and *Mercy* (Fowle) *Adams*, of *Newton, m.*, in 1779, *Lucy Warren*. [Warren, 50-6. Also see *Jackson*, as above.]

[60.] For *Masson*, read *Mason*, N. H.

p. 4. **ALLEN**.—Feb. 1, 1711-12, wid. *JUDITH ALLEN*, of *Boston* [dr. of *Capt. Richard Beers*] for £36, sold to *William Bond*, *William Shattuck*, and *Nathaniel Bright* (trustees for the purchase of lands for *Rev. Mr. Gibbs*) 14½ acres of pasture, bounded N. by other pasture of *Judith Allen*; E. by *David Stone* and *Benjamin Chadwick*; S. by *Bank Lane*; W. by *William Bond*. Also, 3¼ A., bounded N. by highways; E. by *B. Chadwick*; S. by *B. Chadwick*: W. by *Rd. Beers*.

Henry Allen and family moved from *Boston* to *Wat.* in July 1722, and dwelt in a house of *Jabez Beers*. He (H. A.) was probably a grandson of *Captain Beers*.

[10.] *Jemima*, second wife of *Obadiah Allen*, was wid. of *Isaac Tomlin, Jr.*, of *Westboro*, who d. May 19, 1739, and eldest child of *Supply* and *Susannah* (Barnes) *Weeks*,

- of Marlboro, b. 1701. She m. (1st.) May 19, 1730, Isaac Tomlin. Both of her marriages, and the death of her first husband, occurred on the 19th of May.
- p. 6. [41.] Joseph Allen, m. in Camb., Dec. 19, 1700, Elizabeth Robbins.
- [50.] Mr. L. R. Page says, "Dea. Joseph Allen, who d. in Hardwick, Aug. 1793, aged 84 (b. 1709) belongs to this family. He was said to have been born in Weston, and his mother d. when he was very young." His place in the order of births is between Rebecca and the twins, Elizabeth and Ann, who were bap. when a week old. He is supposed to be the Joseph Allen, who m., in Westboro, Feb. 9, 1732-3, Mary, (? Mercy) Livermore, "both of Hassanamisco" (Grafton), and settled in Hardwick, where she d. Mar. 1, 1789, in her 77th year [gravestone], and he d. Aug. 18, 1793, set. 85. In the Hardwick Records, her name is Mercy. [Livermore, 60.]
- [53.] For Daniel, read David.
- [60.] Nathaniel Allen d. before Nov. 16, 1762, leaving wid. Elizabeth and drs. Betty and Tamar, of whom Samuel Stratton was guardian.
- p. 7. [81.] Ebenezer Allen, being under bodily infirmity, cannot keep his father, Lewis, as he hath for 3 years past, and he is committed to his son Abel, with the aid of the town. [Town Records, Jan. 10, 1706-7.]
- [98.] George Allen, with wife Hannah, and son Samuel (living at Josiah Priest's), came from Medford in 1758, and were warned (against settlement). He, with wife Hannah and 2 children, moved from Waltham to Wat. in 1762.

ALLIRE.—Wid. ALLIRE [? Allen] signed a protest respecting the meeting-house in May, 1694.

- p. 8. **AMBLER.**—It is probable that this family moved from Wat. to Cambridge, and afterwards to Stamford, Conn. [See Hinman, pp. 48-9.] Abraham and Richard Ambler, of Stamford, were proposed for freemen, Oct. 14, 1669. Abraham was deputy in May, 1674.

ANDERSON.—Jan. 22, 1713-14, JOHN ANDERSON and wife REBECCA, had leave of the town to build and settle on 10 acres of land in Newton, bought of Nathaniel Sanger, bounded W. by Major Gookin, N. by Isaac Williams, E. by Richard Eccles, and S. by highway. At a meeting of the selectmen, Nov. 18, 1714, Nathaniel Bowman was requested to take John Anderson and family. About July 1, 1731, Mary, wife of John Anderson of Groton, left her husband and came to Wat. She probably returned, as John and his wife Mary came from Groton ab. 1734, to the West Precinct (Waltham), lived in John Smith's house; "caution" was entered against their settlement.

WILLIAM ANDERSON was on a coroner's jury in Wat., July 26, 1669.

ANDREWS.—DANIEL ANDREWS was a proprietor of Wat. 1677, and May 13, 1681, Daniel Andrews, bricklayer, of Salem, for £35, sold to Jonathan Sanders [Sanderson] 35 acres, lying between Samuel Thatcher and Samuel Daniels. Feb. 7, 1681-2, he sold to Richard Norcross three parcels of land in Pound Field, in Watertown. This Daniel Andrews of Salem was probably a son of Thomas and Rebecca, first of Wat., and afterwards of Cambridge. Samuel Andrews was wit. to two or more deeds in Wat. in 1685. In May, 1683, a general survey of Worcester was made by Samuel Andrews of Watertown. [Hist. of Worcester, p. 31.] Was he a brother of Daniel?

ANGIER.—Rev. SAMUEL ANGIER m. Sept. 2, 1680. [3.] For Edward, read Ed. mund. [5.] For Uriah, read Urian. [6.] For 1727, read 1717. Chil. of Rev. S. A. 2. *Hannah*, b. 1682; 3. *Ruth*, b. 1684; 4. *Edmund*, b. 1685; 5. *Samuel*, Sept 1687, d. in Camb. Mar. 6, 1721-2; 6. *Urian*, &c. According to Judge Mitchell [Hist. of Bridgewater, pp. 105 & 6], he had a second daughter *Ruth*, b. in Wat., 1705, who m. (about 1735) Rev. John Shaw of South Bridgewater. This must be a mistake. In the first place, according to the church and town records, he had no daughter Ruth born in Watertown. It was Sarah, who was b. and bap. in Wat., Aug. 1705. In the next place, his dr. Ruth was one of the executors of his Will, when that supposed second dr. Ruth, could have been only 13 years old.

Nov. 18, 1714. The selectmen of Wat. appointed Urian Angier, schoolmaster, "if he be found qualified." He was a physician, and on the 22 Feb., 1719-20, the select-

men voted him 17 s. for attending Nicholas Wyeth. In the m. of Ephraim A., for 1727, read 1717. In the m. of Oakes A., for 1703-4, read 1730-1. Eunice d. in Bridgewater, 1771, unm. aged 73. Ames (eldest child) m. in Boston, in 1708, Margaret M'Carthy, and had son William. Soon after his graduation, the selectmen, on Nov. 22, 1701, agreed with Ames Angier to keep school for £30, those that send to school to furnish $\frac{1}{4}$ cord of wood. [For an account of the family of Rev. John Angier of E. Bridgewater (son of Rev. Samuel, of Wat.), see Mitchell, p. 106.]

p. 9. **APPLIN**.—Ap. 3, 1687. JOHN APPLIN and wife BATHSHUA of Wat., sold to John Dix, 10 A. of land, with house and barn, bounded E. by Henry Spring; S. and W. by highway; N. by John Dix. [7.] For Ap. 7, 1687, read 1688.

p. 10. **BACHELOR**.—JOHN BACHELOR was selectman of Wat., 1636. The lot he sold to Jere. Norcross, was sold by Richard and Jere. Jr., for £20, to Thomas Hammond; bounded E. by Robert Tuck, N. and S. by divided lines. One of the lots of Jer. Norcross was bought of Robert Batchelor.

BACON.—First line, for David, read Daniel. Jan. 20, 1678. DANIEL BACON, of Salem, ship-carpenter, for £20, sold to his brother Isaac Bacon of Camb., tailor, 5 $\frac{1}{2}$ acres in Camb. or Wat., on south side of Charles River, had by deed of father, Daniel Bacon; bounded W. by highway; E. by Wm. Clemence; N. by Jacob Bacon; S. by Isaac Bacon. July 20, 1681. Susanna, wife of Daniel Bacon, Jr. "rendered up her claim of thirds." Mar. 13, 1692-3, Jacob Bacon and wife Elizabeth, living in the bounds of Watertown, for £39, sold to John Barton, of Boston, 7 acres in Wat., bounded E. by Wm. Clement; N. and S. by Ephraim Wheeler; N. by Charles River; W. by highway. The name of John Bacon often occurs in the town records about 1693 to 97. Aug. 15, 1699, money was voted for "John Baken, a distracted man." [See Jackson, p. 234.]

BAILEY.—Rev. JOHN BAILEY was assistant at Old South, in Boston, before his settlement in Wat., and he preached his farewell sermon there July 25, 1686. "July 26 [1686], a considerable troop from Watertown come and fetch Mr. Bailey; some of ours also accompany them." [Sewall's Diary.] I have found no record of a second marriage of Rev. John Bailey; but it is said [Farmer and Mendon Asso. p. 177], that Rev. Peter Thatcher, of Milton, m. for his second wife, the wid. of Rev. John Bailey. The name of the wife of Rev. THOMAS BAILEY was REBECCA. She m. (2d) in Boston, Ap. 26, 1694, William Brown, Jr., Esq. of Salem. [See Farmer.] John Denton, in his Journal of a Visit to N. England, in the winter of 1685-6, says, "I went to visit Mr. John and Mr. Thomas Bailey [in Boston]. These two popular preachers are very generous to strangers; I heard Mr. John upon these words: '*Looking to Jesus,*' and I thought he spoke like an angel. They express a more than ordinary kindness to Mr. Wilkins, my landlord, and (being persecuted in Limerick for their nonconformity) came over with him from Ireland."

For much information respecting the life, the talents, character, and eminent Christian virtues of the saintly John Bailey, see Francis, pp. 50-58; also Cotton Mather's sermon, on the day of his funeral, Magnalia, Book III., Part II., Chap. vii., which is one of Mather's "best things."

Oct. 1, 1754. A certificate was presented to the selectmen, that James Bailey, then of Watertown, had been a member of Christ Church, in Boston, since 1731, where his dr. Elizabeth was bap. Oct. 10, 1731. "Elizabeth, wife of James Bailey, buried in Watertown, Oct. 14, 1754." [Records of Christ Church, Boston.] Mar. 11, 1755. Constant, a slave of James Bailey, of Wat., was fined for horse-stealing.

Mr. Bailey's negro man d. March 1751, and 2 negro children, belonging to him d. in 1749.

p. 11. **BALDWIN**.—[1.] See Saltonstall, 23, Part II.

[11.] Capt. DAVID BALDWIN of Wat. m. ABIGAIL JENNISON. [40.]

[15.] Robert Baldwin of Waltham, b. July 15, 1775, was a posthumous son of Isaac Baldwin, who was killed in the battle of Bunker Hill. James Francis, his 4th child, was b. June 28, not 18.

[15-2-5.] For Clara Ann, read Abby Brown.

- BALL.**—[3.] The records and files of the County Court, in reference to **MRS. ELIZABETH BALL**, furnish a striking illustration of the ignorance and ill treatment of cases of mania at that period. John and Elizabeth Ball had a dr. *Sarah*, b. 1655, living in 1657. By a deed of John Ball, dated Mar. 6, 1660-1, it appears that he then had only three children living. One of them was *John*, another was *Mary*, whose history was a sad one. It has not been ascertained whether the other child, then living, was Hester or Sarah, or what became of her.
- [4.] It is ascertained that this Sarah Bullard was a dr. of George Bullard.
- [12.] John Ball, m. (2d) 1730, Mary Clark. [12.]
- p. 12. [15.] Mar. 36, 1706, James Ball, of Wat., and wife Elizabeth, for £6, sold to Scipio Finney, negro, 12 acres, bounded N. by Allen Flagg; S. and E. by Chester Meadow; W. by Jonathan Sanders.
- [24.] Peter Ball, of Waltham, one of the coroners of Middlesex, in 1774.
-
- p. 14. **BARNARD.**—[1.] For June 4, read June 27.
- [3.] SAMUEL BARNARD, d. Sept. 8, 1683.
- [4-4] Samuel Goffe, m. in Camb. 21, 9, 1682. [Geneal. Reg. vii. p. 58.]
- [5.] In 1722, Sarah Barnard, then of Andover, wid. of James Barnard, of Sud., gave bonds as administratrix. It is probable that she was a 2d wife, and from Andover.
- [6.] Mary Barnard was the 2d wife of Wm. Barrett, of Camb., who lived near the College.
- [3 & 7.] Samuel Barnard and Joseph Barnard, then of Hadley, took the oath of fidelity, Feb. 8, 1678. It is probable that these were sons of John Barnard, of Waterton, but this remains to be ascertained. In 1683, Joseph Barnard was a leading man in Deerfield, Mass. In 1714, William Brown, of Lancaster, sold land in L. to Samuel Barnard, of Hadley.
- [8-1.] Ap. 30, 1706, Sarah Barnard, in her 15th year, chose her uncle Paul Wentworth, of (?) Dover, for her guardian.
- [8-2.] For 1694, read 1693.
- p. 15. [13.] July 25, 1708. Mercy, wife of Ensign Samuel Barnard, was adm. f. c. by Rev. Mr. Angier, and, in the record, he calls her "cousin Mercy," which implies a relationship between the family of Rev. John Sherman and the Angier family. Or, was it because she was a dr. of a ministerial brother?
- [33.] The Will of Jonathan Barnard, dated Aug. 25, 1774, proved June 25, 1776, mentions sons Edmund, Joseph, Benjamin, Nathan, Josiah, and drs. Phebe and Hannah. His inventory, June 28, 1776, by Capt. Edmund Bowman, and Samuel Stearns, £55 5s. His eldest son, Jonathan, not mentioned in the will, probably d. young. His son Josiah, who died in the public service, belonged to the company of Capt. Jonathan Browne. Cornelius and Sarah, not mentioned in the will, probably d. young.
- p. 16. [41.] Nathan Barnard, a soldier of the Revolution, went first to Jeffrey, N. H., afterwards settled in Union, Me. [See Sibley's History of Union.]
- [45.] James Barnard d. before 1742, when his wife was a widow.
- [49.] David Barnard moved to Waltham, in Aug. 1766.
- [54.] Major S. Barnard commanded a company "at Lexington alarm." He was selectman, 1778 and 79.
- [57.] For Painter, read Tainter.
- [60.] From 2.60 in the margin, strike out 2. The estate of James Barnard was divided (lodged, May 16, 1810), to sons James, Jonas (gone out of the commonwealth), Samuel, John, Sally [Sarah], wife of Israel Whitney, Anna, Roxana, and Dolly.
-
- p. 17. **BARRON.**—[1.] The Will of ELLIS BARRON, dated Oct. 26, proved Dec. 19, 1676, contains bequests to wife; to eldest son Ellis, £10; son John, £5; son Moses, £4; to granddr. Elizabeth Barron, "the pyed black heifer." The residue of the estate to be divided into 7 parts among 7 children. Oct 16, 1658, the Court ordered William Fletcher to pay Eliz Barnes [Barron, then Constable of Wat.] 8 shillings, for hue and cry sent out for his servant. Wid. Hannah Barron, in her Will, mentions her "negro, Shippio." [See James Ball. [15] in Part II.] Daniel Barron, of Woburn, in 1653, was probably a son of Elliz, of Watertown.
- ☞ In the early records, the orthography of this name (Barron) is often varied, being frequently written *Barnes*.
- [2.] The Will of Elliz Barron, of Lancaster, dated Dec. 31, 1711, proved Oct. 7, 1712,

mentions wife Lydia; sons Timothy and Elliz; drs. Abigail Houghton, Mehitabel Parker, Hannah Cady, Elizabeth Philbrick, Sarah Taylor, and Grace Stevens. His dr. Elizabeth, m. Ephraim "Philbrook," of Groton. [See Butler, p. 426.] There is a deed, dated Nov. 5, 1706, signed by Ellis Barron, housewright, of Wat., and wife Lydia, conveying house and land in Wat. to Timothy Barron [? his son]. In 1713 [probably the date of the registration, and not of the deed], Ellis Barron, of Lancaster, and wife Lydia, sold to son Ellis, of Groton, and his son Samuel, land in Groton, near to Ephraim Philbrick's. It is probable that he [E. B. [2]] was driven from Groton by Indian hostilities, returned to Wat., with a 2d wife, Lydia, where he remained, until he sold his house and land to his son Timothy, and then (about 1706 or 7) moved to Lancaster.

[9.] Timothy Barron was constable of Wat., in 1715. June 17, 1717, he sold his house and 12 A., and one other lot in Wat., to Jonas Bond, Esq. He d. July 28, 1718, aged 46. It was probably his 2d son, Timothy, who m., in Groton, Jan. 13, 1725-6, Hannah Fletcher, of Chelmsford. His 3d son, Peter, d. in Camb. Ap. 11, 1721, æt. 19 [gravestone]. And it was probably his dr. "Rachel Barns, of Watertown," birth not recorded, who was pub. in Boston with Philip Marret, of B., Jan. 24, 1731-2.

BARSHAM.—Barsham is a Yorkshire name. Coat of arms. Per pale gu. and ar. a chief or. *Crest.*—A garb in fesse. William Barsham was one of a jury of inquest, Sept. 28, 1630, and member of a trial jury, "of life and death," Sept. 19, 1637. He was a selectman in 1653, and was some time sealer of weights and measures. His son JOHN, probably of Exeter, by wife MEHITABEL had the following children.

1. *Annable*, b. May 31, 1670. 2. *Mary*, b. Feb. 26, 1671-2.

3. *Dorothy*, b. Feb. 2, 1673-4. 4. *Surah*, b. Aug. 11, 167-.

5. *William*, b. Ap. 25, 1678. [Record in the State Archives, Concord, N. H.]

Capt. Nathaniel Barsham, was a lieutenant in the forces raised in 1690 for an expedition against Canada. He was town-clerk 1686 and 98; selectman, 1686, 88, 89, and 90.

p. 18. **BARSTOW.**—This orthography of this name has been adopted here, because it has become the almost universal usage. But there is very little doubt that BAIRSTOW is the correct one. This is the orthography very generally used in the Watertown Records, and most frequently in the early Colonial Records, where it is also written Bayrstow. We have the autograph of Michael, the eldest of the four brothers, who came to America, and he always wrote it Bairstow. In his Will and Inventory on record, the Register of probate has written it Barstow, while in the original Inventory, which is on file, it is Bairstow; and it is probable that the Register took the same liberty to alter the name in recording the Will. It is also Bairstow in the Will of his wife's sister, Susanna Halstead. The social position, the respectable and important public appointments bestowed upon Michael Bairstow, imply that he was a man of so much intelligence, that in this matter we may recur to his practice as pretty good authority. This orthography is the one, and the only one, found in Burke's *Encyclopædia of Heraldry*, and the following is the coat of arms belonging to it. "Bairstow. Erm. on a fesse betw. two cotisees sa. three crescents ar. Crest, out of a crescent a demi eagle displ." In Barry's *History of Hanover*, p. 208, is another coat of arms, with a variation in the name and escutcheon, and a different crest, which is as follows. "Barstow, Naburn Hall, York. Ermine on a fesse sable, three crescents or. Crest, a horse's head, coupéd ar." It is probable that the former is the most ancient, and that it is the one, if either, that belongs to the families of this name in New England, and that the latter, more recent, has been granted or assumed, since the Barstows came to New England.

There is no doubt but that MICHAEL BARSTOW, of Wat., was the eldest of the four brothers that early came to this country. Michael Barstow, son of Matthew Barstow, of Shelf, a parish of Halifax, Co. York, was bap. Nov. 17, 1600, and m. Feb. 16, 1624-5, Grace Halstead. It is not known when he arrived, but he was a lot-holder in Charlestown in 1635, and he and his wife were admitted to Charlestown Church, Dec. 5, 1635. (Miles Bastow and Marcia,* his wife.) It is not ascertained at what time

* This seems to imply that he had two wives, 1, "Marcia" (Mercy), 2, Grace. But there are instances on record where the names Mercy and Grace were used the one for the other. This was undoubtedly the case here, as appears by his marriage in England. Susanna Halstead, who was a sister of Grace, wife of Michael Bairstow

he moved from Charlestown to Watertown; but it must have been between July, 1636, when his name was not on the list of those who received allotments of Beaver Brook Plowland, and 1642, when he owned a large homestead and 6 other lots of land. He sold his house in Charlestown to James Browne, which he (J. B.) sold to Abraham Hawkins, Nov. 20, 1643. By his Will, dated June 23, 1674, he gave his "farm [100 acres farmland, not his homestead] to my pastor, John Sherman;" to the church in Wat., £16; to Hannah Barstow, alias Prince, 1 bible, and the debt due by her first husband, William Barstow; to Elizabeth, wife of William Randall, of Scituate, £5; to Susan, wife of Wm. Perry, of Medfield, £5; to Michael, son of John Barstow, d., my upland and meadow, near house of John Traine; also, my lot at Bear Hill; to John and Jeremiah (also) sons of John Barstow, d., each £15; to Dea. Thomas Hastings (exr.) £10; to Dea. Henry Bright (exr.) 40s. The residue to be divided into 10 parts; 2 parts to chil. of brother George, d., and 8 parts to chil. of brother William, deceased. Elizabeth Randall, and Susan Perry, named in the Will, are supposed to be his sisters, but are not mentioned as such. [See Shattuck 15, Part II.] He did not die May 23, 1674, but probably in Ap. or May, 1676, a short time before the date of his Inventory.

William and George Barstow (Beresto) embarked for N. England in the autumn of 1635, without wives, aged respectively 23 and 21 years. It is not known when John Barstow arrived; but according to his age, given at the coroner's inquest, he was born about 1625, showing him to have been at least ten years younger than either of the other brothers.

2. [4.] WILLIAM BARSTOW (next in age to Michael) settled in Dedham about 1636, and he removed thence to Scituate, between 1643 and 1649. He m. Anne —. "He was an extensive landholder, a man of high respectability, and a worthy and enterprising man." He d. in 1668, aged 56, intestate, and admin. granted to his wid., Anne. His Inventory, taken by Robert Stetson and Joseph Sylvester, was sworn to by his wid. Ap. 5, 1669. His wid. m. (2d) John Prince, the first of the name in New England. [See Geneal. Reg. V. p. 383.] Chil. :
 3. 1. Joseph, b. in Dedham, June 6, 1639, of Hingham; m., May 16, 1666, *Susanna Lincoln*.
 4. 2. Mary, bap. in Dedham, Jan. 2, 1642-3.
 5. 3. *Patience*, b. in D. Dec. 3, 1643, m. 1662, *Moses Simmons*, of Scit.
 6. *Sarah Barstow*, a legatee of *Susanna Halstead*, and mentioned in connection with *Deborah* [6], was, without much doubt, a daughter of William, and the one who m. about 1665, *Nathaniel Church*, a carpenter, of Scituate, son of Richard, and elder brother of Caleb, of Wat. [See Mitchell, p. 366. and Winsor's Hist. Dux., p. 245.]
 7. 4. *Deborah*, b. in Scit. Aug. 1650, m. in Wat. Nov. 9, 1670, Dr. Philip Shattuck, of Wat. [Shattuck, 15.]
 8. 5. *William*, b. in S., Sept. 1652, inheritor of his father's homestead; a ship-builder and owner of a sawmill; by wife *Sarah* had 7 chil., and very numerous descendants.
 9. 6. *Martha*, b. in S. 1655, m. Dec. 9, 1674, *Samuel Prince*, a son of her mother's 2d husband. She d. in Hull, Dec. 18, 1684; 5 children, one of whom, *Martha*, m. *Ezra Bourne*, of Sandwich, and their dr., *Mary Bourne*, m. Rev. John Angier, of E. Bridgewater, youngest son of Rev. Samuel Angier, of Wat.
- N.B. It appears by the will of Michael Bairstow, of Wat., that 8 shares of his residuary estate were given to the chil. of his brother William, implying either that there was one child whose name has not been ascertained, or that a double share was intended for the eldest son, which, however, does not appear in the will.
10. [3.] GEORGE BARSTOW, a member of the Artil. Co., 1644, had land granted to him in Dedham in 1642; was a householder of Scituate in 1652, and member of the 2d church. The next year he returned to Camb., where he d., Aug. 18, 1652. He m. *Susannah*, dr. of Dea. Thomas and *Susannah Marrett*, of Camb. where she d. Ap. 17, 1654.
11. 1. *Margaret*, bap. in Scit., Feb. 24, 1649-50.
12. 2. *George*, bap. in Scit., June 12, 1652. Jan. 1690, "George Bairsto," aged 36, was wit. in court at Camb. *George*, son of *George* and *Mary* "Basto," b. in Rox., Aug. 1687.
13. [4.] JOHN BARSTOW, the youngest of the 4 brothers. Strike out the marriage of his widow, and see, above, *Anne*, wid. of his brother William. In the Inventory of Capt. *Bozoun Allen*, dated Sept. 22, 1652, is mentioned a debt due by "John Bersto, at Mr. *Hibbin's* farm." He had 3 children.

was admitted to Charlestown Church only 14 days after Michael and his wife. It is probable that she (S. H.) came over with her sister, and lived and died with her, unmarried.

14. 1. *Michael*, who inherited the homestead of his uncle, Michael Bairstow. See text, p. 18.
15. 2. *John*; 3, *Jeremiah*. Perhaps these are the John and Jeremiah, whom Deane, p. 218, supposes to be sons of William Barstow.
- ☞ For a copious genealogy of the Barstow families, see Rev. J. S. Barry's *Hist. of Hanover, Mass.*
- p. 18. 9th line from the bottom, for Freelove, read Truelove.

BARTLETT.—The Inventory of Thomas Bartlett, dated Jan. 9, 1644–5, £181 16 In May, 1731, Thomas Bartlett was a servant of Mr. Pelham.

BARTON.—Caution against (settlement of) Samuel Barton (? son of James) and family, June 16, 1693. [See Jackson, p. 237.]

BATEMAN.—Ap. 8, 1766. EBENEZER BATEMAN, wife ELIZABETH, with chil. *Jacob, John, Matthew, Stephen*, and *Abigail*, and their sister, Sybil Kent, moved from Rox. to Watertown.

BATHRICK.—JOHN BATHRICK moved from Camb. to Wat., Aug. 1762, and he and his wife SARAH, with dr. *Hannah*, moved to Waltham in Oct. 1766.

- p. 19. **BEACH.**—Oct. 22, 1653, town granted £5 for a cow for RICHARD BEACH. Richard Beach was one of the signers of the original agreement among the early settlers of New Haven. [Hinman, p. 76.] Nov. 30, 1702, Isaac Beach, of Newton, was appointed guardian of Benjamin Whitney [74], his nephew.

BEEKS.—(Beath.) JOHN BEEKS, a cordwainer, of Wat., married, previous to 1721, Jemima, widow of John Abbott. [See Abbott, Part II.] Mr. John Beeks d. June 22, 1746. Mrs. Beeks d. Mar. 4, 1754. Mary, dr. of John Beath, bap. Oct. 30, 1743, Margaret, bap. Ap. 7, 1745. Mr. Beath's eldest daughter d. Feb. 28, 1747. In 1722, there was a suit in court, John Beeks, of Wat., cordwainer, vs. Nutt.

- p. 19. [1.] **BEERS.**—CAPTAIN BEERS was not the first one authorized "to keep an ordinary." See G. Munnings and T. Wincoll, in Part II.
- p. 20. [3.] For 1777, read 1677.
- [9.] Jabez Beers m. Elizabeth, dr. of Jasper Rush, of Dorchester. May 17, 1698. Jabez and Richard [11] Beers, of Wat., sold to Samuel How 300 acres of land in Marlboro, granted to Captain Richard Beers, Oct. 14, 1664. In 1714, Jabez Beers, of Wat., sold land to Joseph Shattuck, of Wat., barber-chirurgeon, and his wife Mary.
- [12.] It is probable that Anthony Beers moved from Wat. to Rox., and there had son Barnabas, b. Sept. 6, 1658. In 1667, lands in Fairfield, Conn., were granted to Anthony Beers, which he sold in 1669.
- [22.] This name, Eleazer, by inadvertence, was misplaced. He was a son, probably the eldest, of Captain Richard Beers, and was one of his executors.

- p. 20. **BELCHER.**—JOSIAH BELCHER and family moved from Braintree to Watertown in 1714.

BEMIS.—The estate of JOSEPH BEMIS [1], was divided, Nov. 18, 1712, after the d. of his wid. Sarah, and it was distributed (except what had been given to "eldest son, Joseph," and dr. Martha), to the following children, viz.; *Ephraim, Mary, Rebecca*, and *John*. As the eldest child, *Sarah* [2] is not mentioned in this distribution, she was probably d. s. p. It appears that *Joseph* [3½] the eldest son lived to have a share of his father's estate, but it is not known what became of him. *Martha* [4], was adm. f. c. by Rev. Mr. Angier, Feb. 25, 1697–8, then aged about 49, unm. *Ephraim*, [7 and 9] settled in Watertown, where the births of four of his children are recorded, but the account of his family is brief. He probably had other children besides those four recorded, and it is probable that his family, or some part of it, moved to Windham and Hampton, in Windham Co., Conn.

- There was a suit in the Mid. C. C. P., in 1714, *vs.* Daniel Bemis, of Wat., and another suit there in 1718, viz., Samuel Bernard, of Wat., house-carpenter, *vs.* Daniel Bemis, of Windham, Conn., since [formerly] of Watertown.* [See Hinman, p. 190]
- p. 21. Susanna Bemis [33.] See Viles 1. [39.] John Bemis, Jr., was constable, 1730, and selectman, 1735.
- p. 22. [52.] Jonathan Bemis, selectman, 1752, 53, 54, 57, 58. [73.] For Weston, read Western.
- p. 23. [80.] May 10, 1756, Nathaniel Allen chosen surveyor of highways, "in room of John Bemis, gone on the king's service." [Weston Town Records.]
- p. 24. [93 or 95?] Abraham Bemis d. 1811, and estate ordered to be sold Oct. 3, 1813. [103.] Capt. J. Bemis, selectman, 1766 to 1770. He d. after Jan. 1, 1771. [110.] D. Bemis, selectman, 1773, 74, 75, 76, 79. [111.] Nathaniel Bemis was captain and selectman of Wat.
- p. 25. [115.] Captain Luke Bemis, selectman of Wat. 1800, 1, 2, 3, 4.
- p. 26. [148.] For Hoar 35, read 65. [155-6.] Strike out Lucius or. For Waltham, read Watertown. His wid. is still (1853) living. For [Gove 20.] read [Gove 18.]

BENJAMIN.—May 20, 1633. Mr. JOHN BENJAMIN was chosen constable of New Town [Camb.] by the General Court. Nov. 7, 1634, he was exempted from training on account of age and infirmity, but was required to have, at all times, arms for himself and servants. He was of New Town, in Oct. 1636, and there was a mistake in saying that his house was burned in Watertown. It is conjectured that he purchased several homesteads in Watertown, of those who migrated to Wethersfield. N.B. The references on p. 27, are to Hinman's Catalogues, 1st edition. See his 2d ed., pp. 196-7.

Inventory of the real estate of John Benjamin, Sen. [1.], proved July 3, 1645. House and meadow next the mill, lot bought of John Bernard, £50; house and 60 acres (homestead) £75; 10 acres of meadow, near Oyster Bank, £10; 10 acres in Rocky Meadow, £13; 8 acres in Great Dividends, £12; 16 acres in Wat., bought Ap. 20, 1645, of Capt. Robert Sedgwick, of Charlestown, £10.

- p. 26. [2.] Nov. 4, 1646. The validity of the Will of Mary Benjamin, "being under age," was set aside by the Gen. Court, and her mother Abigail appointed admin'x.
- p. 27. [3.] Mrs. Abigail Woodward was wit. in Court, June, 1671, then aged 47, showing that she was b. in England about 1624.

☞ John Benjamin, Sen., had a son Joseph, of whom there is no mention in Wat. records, and who settled in Barnstable. He m., June 10, 1661, Jemima, dr. of Thomas and Joice Lambert, of Barnstable. "Oct. 30, 1686, Joseph Benjamin, of Barnstable, sold land in Camb., bounded on land of Abel Benjamin, my brother, which was devised by Will of my honored father, Mr. John Benjamin, some time of Watertown, deceased." William Clark, of Yarmouth, who d. Dec. 7, 1668, by his nuncupative Will, proved Feb. 28, 1668-9, gave his property (£8 3s.) to Joseph Benjamin. [Gen. Reg. vii. p. 178.] There was a Joseph Benjamin and wife Hannah, of Hampton, Conn., as early as 1748, whose lineage has not been ascertained. They had at least 5 chil. [Hinman, p. 197.]

[9.] Joshua Benjamin d. May 6, 1684, aged 42, therefore b. 1642.

[10.] The nuncupative Will of Samuel Benjamin, of Hockanum (Hartford), made about Sept. 18, 1669, "a little before he died," proved Nov. 10, 1670, by Thomas Atwood, aged about 60 yrs., and Thomas Edwards, aged about 47 yrs., gave all his estate to wife Mary, to dispose of at her discretion, and made his brother Abel, overseer. Inventory £98 19. The wid. in Court agreed to pay the two daughters, Mary and Abigail, £10 each, at their marriage, or at the age of 18 years. Of the two sons of

* It is conjectured that the following Bemis family are descended from Ephraim Bemis.

Jotham Bemis, Jr., and wife Tryphema, from Connecticut, settled early in Saratoga, Saratoga County, N. Y., on the margin of Hudson River, and on the road leading from Albany to Skenesborough (now Whitehall). He kept a public house, which was the only one of note between those two places. The high ground, rising in the rear, or on the west side of his house, and known as Bemis Heights, has acquired an historical celebrity, as the place where the battle was fought, which resulted in the capture of Gen. Burgoyne and his army. Gen. Gates occupied the house of Mr. Bemis, as his headquarters, until after the battle of Sept. 19, 1777, when it was occupied by Gen. Lincoln, and Gen. Gates removed his headquarters to the house of Captain Ephraim Woodward, on the Heights.

Mr. Bemis had 5 children. 1. Jonathan. 2. William, who both moved from that town. 3. John, who settled on the homestead, but moved to the town of Saratoga Springs, where he and his wife both d. about 1828, s. p. 4. Sally, m. — Crawford, and is now, 1868, living at Saratoga Springs, aged 85. 5. Nancy.

SAMUEL BENJAMIN, of Hoccanum, the eldest, *Samuel*, had a son, Samuel, and two daughters. His 2d son, *John*, of Hartford, m., in Hartford, HANNAH ———. His Will, dated Oct. 14, proved Nov. 1753, appointed his son Gideon exec'r and residuary legatee. Inventory of his real estate, dated Dec. 26, 1753, amounted to £1870 (? O. T.). The Will of his wid. Hannah, dated Dec. 7, 1754, mentions sons Samuel, Gideon, and Caleb, and makes the latter exec'r and residuary legatee. Children of John and Hannah, of whom the births of only two are recorded.

1. *David*, of Hartford, m. Ruth ———. May, 1749, admin. on his estate was granted to his wid. Ruth. Inventory presented Sept., 1749, £211 17. His wid. Ruth was appointed guardian of his chil., Feb. 4, 1752, viz.: 1. Samuel, about 7 years old. 2. David, about 4. 3. Jonathan, aged about 2 years.

2. *Gideon*, ex'r of his father's Will, and residuary legatee; chil. 1. Gideon, grandfather of late Edwin Benjamin, of Hartford. 2. Jonathan, m. ——— Woodbridge, and had children.

3. *John*, to whom his father bequeathed £50.

4. *Samuel*, b. May 30, 1708, had also a bequest of £50.

5. *Caleb*, b. July 15, 1710, had of his father a house and four acres on E. side of the river; was exec'r and residuary legatee of his mother, in 1754.

6. *Ann*, had a bequest of her father of £30.

[11.] CALEB BENJAMIN, of Wethersfield, m. MARY HALE, b. 1649, dr. of Samuel and Mary Hale, of Wethersfield. [Hist. of Glastenbury, p. 166.] He d. May 8, 1684, intestate. Inventory, £77 15s. 6d. Admin. granted Sept. 4, 1684, to his wid. Mary, who afterwards (?) m. Walter Harris, Sen., of Glastenbury. Chil. of whom John and four drs. were living, Nov. 4, 1710.

1. *Mary*, b. Sept. 15, 1671.

2. *Abigail*, b. Ap. 27, 1673, m. Dr. Ebenezer Hills.

3. *Sarah*, b. Feb. 17, 1675.

4. *John*, b. Nov. 5, 1677, "eldest son," and had a double portion; m. (1st) July 26, 1699, Ann Latimer. He m. (2d) Mary, dr. of Philip Smith, of E. Hartford, where he resided some time, and afterwards moved to Stratford. Ap. 27, 1699, John Benjamin, of Wethersfield, Conn., weaver, eldest son of Caleb, late of Wethersfield, and grandson of John, of Wat., sells to kinsman, Daniel Benjamin, of Wat., Innholder, his right in 60 acres in Wat., formerly of his grandfather, John. Chil. by 1st wife,

1. John, b. in Wethersfield, May 12, 1700. 2. Ann, b. in W., Jan. 1, 1704.

5. *Samuel*, b. Feb. 14, 1680, d. before 1710, probably s. p.

6. *Martha*, b. Jan. 19, 1681.

7. *Caleb*, b. 1683, of Hartford, late of Stonington; d. intestate and s. p. Admin. granted to his brother John, Nov. 15, 1709. His estate (£9 6s.) was divided in 1710, viz., a double share to his brother John, and a single share to each of his four sisters.

[12.] AMITHEA, wife of Abel Benjamin, was adm. f. c. in Charlestown, May 14, 1676, and he was adm. f. c. Sept. 8, 1700.

[13.] John Benjamin, Jr., m. Lydia, dr. of William Allen. The Will of William Allen, dated Dec. 15, 1674, mentions his dr. Lydia, wife of John Benjamin, of Watertown [Suff. Wills, vi. p. 78]. Ap. 5, 1681, John Benjamin, aged about 61, upon his petition to the Court, was exempted from training. Jan. 12, 1696-7, John Benjamin sold to his sons, Daniel and Abel, 60 acres in Dorchester Field [? the homestead of John, Senr.] bounded S. by Charles River, E. by William Bond and Dorchester Field, W. by heirs of John Loveran, N. by Robert and Jonas (? Josiah) Goddard.

p. 27. [19.] Daniel Benjamin took the oath of fidelity, Dec. 1677.

[25.] For Saagar, read Sanger.

p. 28. [33.] Abel Benjamin belonged to Capt. Jonathan Brown's Co., that went to Fort Wm. Henry in 1758, and on the return list he is marked as deceased.

[43.] Strike out this m. of Mary, and see [51.] below.

[44.] For 1738, read 1710. Daniel Benjamin, Jr., was selectman of Wat., 1735, 36, and 37, before Waltham was incorporated. [See Bond, 88, Part II.]

[49.] He (J. B.) d. Aug. 28, 1742. His wid. d. Aug. 8, 1748.

[51.] Mercy Benjamin, m. Nov. 23, 1738, Nathan Munroe, b. Sept. 11, 1716, son of Joseph and Elizabeth, of Lex.; settled in Concord and had a numerous family. [See Locke Fam. p. 311.]

BETTS. (? Bates.)—ROBERT BETTS, of Wat., was probably the Robert Beast and Best, of Sud., one of its first settlers. There were early settlers of this name in Connecticut and on Long Island.

- p. 29. **BIDLESTON.**—For Nov. 3, read Nov. 23. William Bittlestone, supposed to be a son of Thomas, d. in Camb., Oct. 5, 1640, before the date of the will of his father.

BIGELOW.—[1.] JOHN BIGELOW, Senr., was b. in 1617, according to his age, given as a witness in Court. His Will, dated Jan. 4, 1702, 3, mentions his wife (not named), sons John ("the eldest"), Jonathan, Daniel, Samuel, Joshua; drs. Mary Flagg, Elizabeth Sternes; chil. of dr., Sarah Larned, drs. Abigail Harrington and Martha Woods. Son Joshua and son-in-law Isaac Larned, ex'rs. Capt. Benjamin Garfield, overseer. The Inventory of his real estate, dated July 16, 1703. House and about 13 A. of land, £160; 20 A. Dividend land, £15; 6 A. of meadow, east of Beaver Brook, £20; 5 A. at 4 mile Brook, £10; part of estate left by the widow's father, Bemis, to his dr. Sarah, relict of the deceased, not really known. The administrators' account mentions payment of legacies to chil. of John Stearns, and chil. of Obadiah Wood. Also a charge, 2s., for a man and horse to notify John Stearns, at Billerica to attend the funeral. Also, 3s. for a man and horse to Sherburne to notify Isaac Larned and wife to attend the funeral.

- [10.] As there is no reference to a son James, or his family in the father's Will, it might raise a doubt whether John had such a son; but the record of his marriage, by Rev. Mr. Bailey, must remove all doubt. "Upon the 25 March, 1687, at my own house, in Watertown, I married James Begalow, the son of John Begalow, and Patience Brown, the daughter of Jona. Brown, with their parents' full consent, being legally published," &c.
- p. 30. [†20.] For other information concerning Major John Bigelow, see note in Hinman, p. 211. He did not belong to the expedition to Canada in 1775, under Arnold. It was Major Timothy Bigelow [193] who belonged to that expedition.
- [†22-1.] RICHARD BIGELOW, Esq., of N. York City, m., Sept. 3, 1823, MARTHA SMITH, b. Nov. 28, 1798, dr. of Dea. Normand Smith, of Hartford, Conn. Chil.,
1. *Mary Elizabeth*, b. Mar. 10, 1826, m., June 7, 1848, George R. Lockwood, merchant, of New York.
 2. *Richard Hillyer*, b. Aug. 22, 1827, a merchant, of N. York, m., Sept. 25, 1851, Columbia L. Johnson, of N. York.
 3. *Frances*, b. Sept. 1, 1829.
 4. *Eliza King*, b. Sept. 24, 1831.
 5. *Alfred*, b. Sept. 25, 1833, d. Mar. 12, 1834.
 6. *Martha*, b. Ap. 2, 1835.
 7. *Edward*, b. Mar. 27, 1837, d. Jan. 22, 1852.
 8. *James*, b. Feb. 25, 1839.
- [†22-4.] JOHN BIGELOW, a merchant, m., Oct. 1838, JANE ASHLEY HINMAN, dr. of Royal R. Hinman, Esq. Chil.,
1. *Jane Frances*, b. Oct. 11, 1839.
 2. *John H.*, b. Aug. 8, 1841, d. at Hartford, Sept. 22, 1844.
 3. *William Henry*, b. at Hartford, Aug. 19, 1845, d., at Boston, June 9, 1846.
 4. *George Ashley*, b. Feb. 12, 1848.
- [†28.] For 1799, read 1699.
- p. 31. [18½.] For a full account of the family of Jonathan and Abial (Bigelow) Stone, see Barry, p. 407.
- [22.] Samuel Bigelow was by trade a carpenter, and he was selectman, 1697, 1708, 9, 10, 13, 14, 16. Nov. 21, 1686, John Bigelow and wife Mary, of Wat. executed a gift deed of 16 acres to son Samuel, being the land on which Samuel now lives.
- [24.] For Bruce, read Brown (? Daniel).
- [26.] Sarah Bigelow and Josiah How, jr., m. Dec. 14, 1706.
- [31-6.] Abigail Bigelow, b. Ap. 13, 1723, m., Dec. 18, 1745, Capt. Dijah Fowler. [For her family, see Geneal. Reg. vii. p. 131.]
- p. 32. [44.] Nov. 7, 1692, Abraham Brown and wife Mary, for £40, sold to his brother-in-law, James Bigelow, 107 acres, as it was first granted in the farm-grants, bounded S. and E. by John Wincoll, S.W. by — Stimson, N.W. by Geo. Munning, N.E. by highway. In 1696, he mortgaged those 107 A. to Joseph Lynde, of Boston, and was discharged Aug. 3, 1703.
- [45.] For 1668, read 1688.
- [46.] Patience Bigelow m. in Groton, Nov. 29, 1720, Samuel Woods, of Groton. She had 8 chil., and d. Jan. 23, 1771. A Patience Bigelow is mentioned as "only daughter and heir" of James B. This was probably the daughter of James [45].
- [57.] See Worcester Mag. II., pp. 155 and 156.
- [60.] See Thomas Hammond 31, in Part II.
- In the margin, 3d line from the bottom, for 25. 29, read 25. 69.

p. 23. [72.] (IV.) Cornelius Bigelow, of Marlboro, who had owned the covenant in Grafton, m. Dec. 28, 1731, Mary Greaves, in Westboro, where he settled. She was admitted f. c. Aug. 16, 1746.

1. *Cornelius*, b. Dec. 30, 1732, m. in Westboro, Feb. 1, 1754, Sarah Miller; was adm. f. c. Aug. 30, 1760.
2. *Mary*, b. Jan. 23, 1735 [? 4], m., May 26, 1758, Jona. Cook.
3. *Betty*, b. Aug. 12, 1735, d. Ap. 15, 1764. 4. *Paul*, b. May 8, d. June 23, 1739.
5. *Paul*, b. Jan. 21, 1740-1, m. (pub. May 23), 1761, Hannah Ober, of Upton.
6. *Noah*, b. Sept. 9, 1742, m. (pub. Dec. 14, 1765), Catherine Shas, (? 2d wife) of Hop.
 1. Noah, b. June 29, 1762. 2. Roger, b. Mar. 18, 1768.
7. *Eunice*, b. Oct. 6, d. Oct. 20, 1750.
8. *Job*, b. Ap. 1753, d. Dec. 26, 1766.

p. 33. [78.] Lieut. Thomas Bigelow, and wife Mary, were dismissed from Wat. 2d Church (Waltham) to Marlboro, June 23, 1723, about 17 years after they moved thither, and only a short time before he returned to Watertown. He was selectman of Wat. (before the incorporation of Waltham), 1727, 28, 33, 34, 36, 37.

p. 34. [112.] Elisha Bigelow, of Westminster, m., in Lunenburg, Dec. 1, 1757, Sarah Goodridge, of Lunenburg.

[115.] Jabez Bigelow was a Lieutenant at West Point, at the time of Arnold's treason. He settled in Westminster, where he had ten children, all of whom m., and had chil., and he d. aged 90. His son Benjamin, b. Aug. 6, 1765, m., in 1790, Rebecca Roman, and removed from Westminster to Boston in 1802, and thence to Camb. in 1804. He was actively engaged in mercantile pursuits until 1835, when he retired, with a competency, to the "Inman Farm," in Camb., where he d. Feb. 24, 1849, in his 84th year. His wife d. about 1844. He was a volunteer in the force sent to suppress Shay's Insurrection. He was repeatedly Rep. of Camb., was often Selectman, and much employed in the municipal offices of the town. [See Geneal. Reg. iii., p. 196.]

[118.] Benjamin Bigelow moved to Lun., where he had a dr. Hannah, b. Mar. 5, 1754. His wife, Love, d. June 18, 1754, and he m. (3d) Oct. 31, 1754, Elizabeth Colburn, by whom he had son Benjamin, b. Oct. 4, 1755.

[121.] See Ward, Hist. of Shrewsbury, pp. 230, 31.

[134.] Was this the Joshua Bigelow, housewright, of Sutton, who d. previous to Sept. 1758, leaving wid. Elizabeth?

p. 35. [140.] After Bullard, strike out, b. July 28, &c., and insert, b. May 22, 1718, dr. of Joseph and Elizabeth (Traine) Bullard [11.] Abraham Bigelow was Rep. of Weston, 1755, 59, 64, 65, 66, 68, 69, 70, 71, 72, and he was much occupied with the municipal business of the town.

[146.] For Spreig, read Spring. [151.] For Aschel, read Asahel.

[152.] Mr. Henry Bigelow's death was occasioned accidentally by his friend Nathaniel Saltonstall. [156, Part II.]

[156.] For [Brown, 408], read 108. [157.] T. B. m. in Rox., Nov. 24, 1774, Elizabeth Wales.

p. 37. [†191.] For William, read Williams.

p. 38. [188.] Moses Bigelow, then "of Wat.," belonged to Capt. Jonathan Brown's Co. at Lake George, in 1758.

[195.] Mrs. Lucy (Prescott) Bigelow, d. Dec. 15, 1852. For additional information respecting Hon. Timothy Bigelow, see "The Hundred Boston Orators," pp. 298-304.

p. 41. **BINNEY.**—See Spring [60], note, p. 445.

BIRD.—BENJAMIN BIRD m., in Wat., Nov. 9, 1775, MARY PRENTICE, (?) dr. of Smith Prentice, of Wat., q. v.

p. 42. **BISCOE.**—(Brisco.) [1.] Mr. NATHANIEL BISCOE was Selectman, 1648 and 50. It is probable that he was a Baptist, agreeing in sentiment with Dr. John Clarke, with whom he was associated in England. His letter to Mr. Thomas Broughton, of Boston, his son-in-law, shows that he was an acute observer, a clear, independent thinker, and a terse, vigorous writer; and it is easy to conceive that such a writer, attacking the politico-ecclesiastical policy of Massachusetts Bay, would make a very sensible impression. In encountering such a disputant, it was very discreet for

Hubbard to conclude, *fuste potius erudiendus quam argumento*. [See Hubbard's History, chap. xlviii.] The 47 acres of land which he purchased of the town and sold to John Wincol, about the time of his return to England, was bounded N. by Thomas Straight, common land, Beaver Brook, and land of John Whitney, E. by highway to Concord [now Lexington Street], S. by Isaac Sternes, Bartholomew Pier-son, George Bullard, and Anthony Pierce, W. by highway, N.W. by John Warren. The Inventory of his son, John, renders it probable that this land was returned or reverted to him, and the probability is strengthened by the circumstance, that this lot is not, as I think, mentioned in any of the several sales made by Capt. Wincol, about the time he moved to Kittery. This lot seems to coincide, in part, with the land which Andrew White and Nathaniel Stearns bought, in 1713, of Elisha Cooke, of Boston. [See White, 5.] Notwithstanding the disparaging tone of Winthrop's Journal, respecting "one Briscoe," it is evident from the records, that his townsmen entertained a high opinion of his capacity and integrity. On important committees, "Mr. Briscoe" was generally placed at the head. Sept. 8, 1647, for £7 16s., he bought land in Boston (mortgage) of Angel Holland, shoemaker, of Boston. [See Geneal. Reg. iv. 319.]

[2.] It is conjectured that Nathaniel Brisco, Jr., soon after his difficulty with Nathaniel Eaton, the first principal of Harvard College, went first to Wethersfield, and very soon proceeded to Milford, Connecticut, where other Watertown emigrants settled, where his name is on the first list of free planters, Nov. 20, 1639, and where he was admitted to the Church, Ap. 20, 1644. The records show, that he had a share in the business of the town, and that he was a proprietor of several lots or tracts of land. It is probable that in the autumn of 1651, he came to Watertown to take leave of his father, then about to return to England. We may infer from the letter of his father to Mr. Broughton (Sept. 7, 1652), that he had settled at a considerable distance from Mr. Broughton, then of Boston. No record of his marriage, nor of the birth of his children, has been discovered, but it is supposed that he had two children, Nathaniel and James. He d. in 1683.

1. NATHANIEL, of Milford, adm. freeman, Oct. 1669, m. in Milford, Nov. 29, 1672, MARY CAMP, (?) dr. of Nicholas Camp. He probably d. before 1701. Chil.,

1. James, b. Aug. 14, 1673.

2. Mary, b. Nov. 15, 1675; m. — Buckingham, was a wid. in 1712.

3. Samuel, b. Ap. 4, 1678; m. (1st), Oct. 23, 1707, Ruth Smith. She d. in childbed, Nov. 17, 1709, leaving one child, Ruth. He m. 2d, July 3, 1712, Abigail (?) Olcott. Chil., 1. Ruth, b. Nov. 9, 1709. (By 2d wife, Abigail), 2. Samuel, b. Sept. 9, 1713. 3. John, b. June 8, 1715. 4. Nathan, b. July 15, 1717. 5. Abigail, b. Mar. 1, 1721. 6. Isaac, b. Feb. 6, 1729-30.

4. Sarah, m. Thomas Tibbets.

5. Abigail, b. Nov. 1, 1684, m., May 21, 1711, Ezekiel Newton.

2. JAMES, of Milford, adm. freeman, May 11, 1671; m. in Milford, Nov. 6, 1676, SARAH WHEELER (? dr. of Joseph). He d. between 1709 and 1711.

1. Sarah, b. Mar. 25, 1678.

2. James, b. Aug. 25, 1679; m. June 1, 1699, Elizabeth Adams. Chil. 1. Mary, b. Mar. 8, 1701. 2. Elizabeth, b. July 20, 1704. 3. Abigail, b. June 26, 1706. 4. Nathaniel, b. June 16, 1708. 5. Mehitabel, b. Oct. 11, 1712. 6. James, b. Mar. 5, 1713. 7. Sarah, b. Feb. 23, 1718-19. 8. John, b. Ap. 22, 1721.

3. Hannah, m. Mar. 26, 1714, Joseph Baldwin.

[3.] There were families of the name of Broughton, in Windham, Conn. [Hinman, p. 351]. Perhaps they may yet be ascertained to be descendants of Thomas, of Watertown.

p. 43. [4.] For, between 1650 and 1680, read, 1652 and 1682.

[5.] Dea. John Jackson. For a full and satisfactory account of his parentage and family, see Jackson's History of Newton, p. 328, &c.

[10.] Hannah Jackson, was the 2d wife of James Trowbridge, Jr. See Trowbridge, [14] in Part II. She m. (2d), Feb. 22, 1716, John, eldest son of Joseph and Lydia (Jackson) Fuller, [53, in Part II.]

[12.] For, High Sheriff of Camb., read, of Camb. High Sheriff of Middlesex. &c. &c.

[19.] In deeds, he (John Biscoe) is designated as "late of Cambridge, mariner," Oct. 13, 1712, John Biscoe, of Wat., and wife Sarah, sold to Thomas Whittermore, of Camb., 20 A. of land in Wat.; bounded E. by J. B., S. by Thomas Traine and Henry Spring, W. partly by H. S. and partly by John Hammond, N. by Camb. line.

Mar. 5, 1715, wid. Sarah Biscoe, of Camb., by authority of court, sold to Abraham Hill, of Charlestown, 25 A. adjoining the above lot. Wid. Sarah Biscoe, m. Daniel Gookin, previous to Mar. 1716-17.

[23.] Capt. Thomas Biscoe, was a shipmaster, sailing out of Boston. Between 1740 and 46, he sailed on a foreign voyage, and never returned or was heard of. He left two sons, John and Josiah, and a daughter, Abigail, bap. in Wat. (after the death of her father), Oct. 8, 1749. His wid. m. about 1746, ?—Mann. Tradition says the two sons, John and Josiah, were sent to Spencor or Worcester (? Woodstock), and their handsome inheritance fraudulently wasted by their mother and her second husband.

p. 44. [27.] Jacob, d. Ap. 6, 1837.

[30.] Josiah Biscoe, was Selectman of Wat., 1782 and 87, Town Clerk, 1784, and Assessor, 1777 to 87, and 1793. He moved to Paris, Me., about 1793, where his 2d wife, Mary, d. about 1831, he d. Sept. 8, 1812. Chil. all b. in Wat.

1. DANIEL WHITNEY, b. Nov. 17, 1765. He spent most of his boyhood and youth with his uncle, Daniel Whitney, of Watertown. He was a tanner (the family trade), went to Walpole, N. H., about 1794; m. Oct. 20, 1796, ESTHER PARTRIDGE, b. May 13, 1771, dr. of Samuel and Keziah (Hawes) Partridge, of Franklin, Mass. He was a Selectman of Walpole, and Rep. in the State Legislature. She d. June 5, 1826, and he d. May 16, 1828, aged 62. Chil.,

1. *Sophia*, b. Aug. 7, 1797, d. Ap. 20, 1799.

2. *Leonard*, b. Jan. 9, 1800, in Walpole, where he resided until 1843; was Selectman 8 or 9 yrs., Rep. in the State Legislature, 4 years; member of the Governor's Council, 1838; was then appointed clerk of the courts in Cheshire County, which office he now (1854) holds, and he has resided in Keene, since 1843. He m. Oct. 24, 1831, Meliscent Kittredge, of Walpole, [Bond, 207.] She d. May 27, 1851, and he m. (2d) Dec. 23, 1852, Lucy Ann Dodge, b. Jan. 23, 1832, dr. of James Dodge, of Keene. Chil.,

1. Henry Leonard, b. Feb. 9, 1833, d. May 14, 1839.

2. Josiah Leonard, b. July 17, 1839, d. Sept. 8, 1841.

3. *Elmira*, b. July 17, 1802, d. Sept. 5, 1803.

4. A daughter, b. and d. July, 1807.

2. GRACE, b. Oct. 2, 1767, m. Ap. 21, 1796, Wm. Winchester, of Wat., q. v.

3. THOMAS, b. Aug. 31, 1769, a grocer, of Cambridgeport, of the firm Trowbridge and Bisco. He m. June 12, 1808, Bathsheba How, dr. of Ezekiel and Sally (Read) How, of Fram., and a sister of Sally How, who m., May 6, 1804, his partner, John Trowbridge, [See Barry, p. 425.] He d. Jan. 10, 1816. Chil.,

1. *Thomas Curtis*, b. July 18, 1810, grad. Amh. Coll. 1831, studied divinity, became pastor, first of a Cong. Church in Brattleboro, Vt., where he m. — Lord. He is now (1853) pastor of a church in Grafton, Mass.

2. *Bathsheba Eliza*, b. May 10, 1812, d. about 1835.

3. *Maria How*, b. June 27, 1814, of Boston, m.

4. LEONARD, b. Mar. 29, 1773, engaged in mercantile pursuits in Boston and Marblehead. About 1800, he went abroad as supercargo in a vessel, in which he had a considerable adventure, and no certain intelligence of him, or of the vessel, was ever afterwards received.

(By 2d wife, Mary Mason.)

5. MARY, b. May 3, 1775, d. 1776.

6. JONAS, b. Nov. 1, 1777, d. in Paris, Ap. 6, 1810, unm.

7. MARY, b. May 1, 1783, m. Alanson Mellon, Esq., for more than thirty years Register of Deeds, in Oxford Co., Me. He d. Dec. 9, 1851.

1. *Leonard*, b. June 21, 1813, d. June 17, 1843.

8. AZUBAH, b. Mar. 5, 1787, unm.

BLACKLEACH.—See Bowman, 4½.

p. 44. **BLOYS.**—(Blois.) [1.] EDMUND BLOYS, "a planter," m. in Camb. Sept. 27, 1675, RUTH PARSONS. June 12, 1681, wid. Ruth Bloys, sold to Henry Godden, of Wat., about 4 A. of land, late in the possession of her father, Hugh Parsons, d.; bounded W. by King's Common, N. by Thomas Philpot, E. by William Priest [Price], S. by William Shattuck, with condition that she "shall have room in the house where he [H. G.] shall dwell, and, when I am afflicted with the infirmity I am

subject unto, he and his wife shall take such care of me to prevent my hurt to myself," &c. Jan. 24, 1687-8, she expressed her desire to the selectman, to live with Henry Godden, for the sake of early acquaintance with his wife. He not willing to bear the charge of her maintenance, expects house and land, formerly of the father of Ruth. May 20, 1698, voted, Henry Godden to be free from rates as long as he finds Ruth Blois house-room and firing. July 19, 1698, voted that Henry Godden's land, where his house stands, shall be legally confirmed to him, within one year after the decease of wid. Blois. Feb. 8, 1698-9, wid. Ruth Bloys, of Wat., ex'x. of Edmund Bloys, sold to Joseph Child, 40 A. of land in Wat. At a meeting of the selectmen of Wat., Dec. 21, 1711, ordered 4 galls. of wine, also sugar and spice, that Ruth Bloys (who lies dead), may have a decent funeral. [See Parsons, p. 391, and in Part II.]

[2.] May 2, 1666, wid. Michael Bloys, left with three young children, requested that her father-in-law, Edmund Bloys, and her brother, Samuel Jennison, be appointed administrators. For 1647-8, read 1657-8.

p. 45. **BOND.**—In the 27th line, and in the note, for Somerley, read Somerby.

In the 36th and 40th lines, for Haugley, read Haughley.

[5.] For 1695, read 1595. [6.] For 1697, read 1597.

The following was extracted from the registry of the Deanery of Norfolk, by Mr. Somerby:—

Thomas Bond, of Shadwell, in his Will, dated Feb. 12, 1609-10, proved Ap. 18, 1610, gives to his wife, Alice, house and land in Woolpit [a village and parish 6 or 8 miles E. of Bury St. Edmunds, on the road to Ipswich], during her life; after, to Thomas, son of Jonas Bond, late of Bury St. Edmunds, deceased: said Thomas to pay the following legacies. To the daughters of John Halstead, Susan and Elizabeth, 40s. each. To the wife of Andrew Halstead, 40s. To Henry Lukyffe, of Buxhall, 40s. To Hester Browne, 20s. To his wife's sister's children, 20s. to be divided between them. To Peter Mathan, 10s. Appoints wife executrix. [Jonas Bond had previously given his own house in Woolpit to his son Thomas.]

p. 46. In lines 12, 25, 29, for Farnham, read Fornham.

In 6th line from the bottom, for [Biscoe, 7] read [Biscoe, 18.]

Elizabeth, wid. of William Bond, d. Aug. 24, 1720, aged 82. He was a juror, Oct. 2, 1660. By the court, Dec. 17, 1662, William Bond was allowed 3s. 6d., for his expense of time and charge for the country [? county], the last year, in the office of constable. June 20, 1682, "Corporal William Bond, Sen.," was appointed one of a committee to lay out a highway for Sherbourne, and the farms adjacent, from the Lower Falls on Charles River, to Watertown Milne [mill], and make return to the next court. Oct. 9, 1694, "Capt. William Bond" was one of a committee to view Charlestown Highway, by Cook's Mill. Notwithstanding the prominent position he held [see text, p. 47], he is often designated in the records, even towards advanced age, as Corporal Bond. "Captain William Bond, Esq.," d. intestate, and administration was granted, Jan. 6, 1695-6, to his sons, William, Nathaniel, Thomas, and Jonas. July 2, 1671, Nathaniel Treadway, and wife Sufferana, sold to William Bond, farm land, had of John Wincoll, May 26, 1663 [described in Mid. Deeds, III. p. 22-3], since laid out into five parcels. This was probably the land, the whole or a part of which was conveyed as follows: July 3, 1700, William Bond (and wife Hepzibah), Thomas Bond (and wife Sarah), Jonas Bond (and wife Elizabeth), administrators of their father William: for £36, sold to Samuel Jones [Jones, 32], a farm of 84 acres, bounded N. by Squadron Lane, W. by Nathaniel Bright, E. by Jonathan Bullard.

p. 47. [9.] For June 22, read June 21. She (Mary), d. May 21, 1700, aged 31; born, therefore, about 1669.

[10.] The Will of Dea. William Bond, dated July 13, 1724, proved Dec. 27, 1725, mentions wife Hepzibah, son Samuel (to whom he gave 20s. having had a full proportion), dr. Margaret Coolidge, dr. Deliverance Wellington, dr. Mary Benjamin, gr. son Jonathan Knapp, dr. Hepzibah, son William, son Nathaniel, Exr.

p. 48. [18.] It is supposed that this family moved to Sturbridge. In 1759, Nathaniel Bond was ensign in Capt. Jeduthan Baldwin's Company. In November, 1760, Nathaniel Bond, of Sturbridge, was 2d Lieut. in Capt. J. Fletcher's Company.

[21 and 22.] Mar. 19, 1711-12, Elizabeth and Sarah, drs. of John Bond, quitclaimed to their brother Daniel all right in their father's estate.

[24.] Inventory of real estate: House, &c., and 30 A. of land, £150; 3 A. of marsh, in Camb., S. side Charles River, £30; 144 A. of farm land, £40.

- [28.] For 1790, read 1690.
- [30.] Ap. 2, 1725, Isaac Bond, of Wat., for £130, bought of Joseph Nash, of Sherburne, land in Sherburne, laid out 14 A., more or less, but esteemed 30 A., bounded E. by highway, N. and W. by Isaac Coolidge, S. W. by Samuel Perry and Eleazer Rider, S. by Dividend land of Rev. D. Gookin and by Benjamin Whitney. For June 1764, read 1763.
- [31.] Lieut. N. Bond was assessor, 1695; selectman, 1696; juror, 1692. His Will, proved Ap. 15, 1700, mentions son Nathaniel, the eldest; son John; only dr. Bethia, to whom he gave her mother's effects; "to my nurse, wid. Hannah Child, £10" [wid. of Richard Child [2]]; brothers Jonas Bond and Jonathan Fuller; ex'rs. Inventory: House, &c., 47 A. farm land and 1½ meadow, £120; 1 house and 14 A. and 47 A. farm land; 12 A. in lieu of township and 3 A. in Chester Meadow, £65.
- Mar. 11, 1694-5, William Bond [1.] sold to son Nathaniel a house and 21 acres, bounded S. by Charles River, W. by Beaver Brook, N. by highway and Capt. John Warren, E. by John Whitney. Also, 97 A., first granted to Thomas Arnold, the 8d lot, bounded E. by Joseph Peirce, W. by Thomas Waight, N. by Camb. (Lex.) line, S. by Division line, £85.
- p. 49. [33.] Bethia Bond, b. 1693 (according to her age at her decease), m. Nathaniel Oliver, of Cambridge [b. Feb. 1, 1685, son of Dea. Thomas, Esq., and Mary (Wilson) Oliver, of Camb., grandson Rev. John and Elizabeth (Newgate) Oliver, of Rumney Marsh, and great-grandson of Elder Thomas Oliver, of Boston, who came to New England in 1631.] She d. a widow in Dec., 1784, aged 81. The Boston News Letter, of Dec. 22, announcing her death, says, "her only child [Mary] is the amiable consort of Thomas Sparhawk, Esq." Thomas and Mary (Oliver) Sparhawk had Thomas, b. Mar. 16, 1736-7, grad. Harv. Coll. 1755. For an account of this Thomas, Jr., and family, see p. 545. Jonathan Fuller, of Newton, uncle of Bethia Bond, bequeathed £2 to the wife of Nathaniel Oliver. [See Jackson's Hist. of Newton, pp. 279, 331, 373, and 4.]
- [34.] Dec. 17, 1705, John Bond, aged 16, chose his uncle, Jeremiah Fuller, of Newton, for his guardian.
- [35.] Col. Jonas Bond m. (2d) in Boston, Nov. 13, 1699 (by Samuel Sewall, Esq.), Elizabeth Prentice. [See Prentice Fam. p. 163.] He was selectman 18 yrs., 1701-1727; moderator, 1718, '19, '20, '23, '24, '26, and '27. He was one of the Committee (of the General Court) for issuing £100,000 Bills of Credit. [Committee in 1716, '17, Charles Chambers, Jonathan Davis, Jonathan Remington, Edmund Goffe, and Jonas Bond, Esquires. See Felt's Massachusetts Currency, p. 70.] Ap. 6, 1703, he ("Justice Bond") was appointed one of the Committee to view the jail in Cambridge; reported, Sept. 14th, and advised to build at the west end 18 ft. square. Dec. 10, 1706, he was appointed by the County Court, one of a Committee for altering the course of the road from Watertown Mill to the Lower Falls. Sept. 30, 1707, he was appointed on a Committee to build a Court House in Cambridge. Dec. 9, 1718, he was appointed by the Court on a Committee to visit the different towns and regulate the valuation, per order of the General Court. Mar. 10, 1723-4, he was appointed on a Committee to settle Grand Jurors' accounts. At the same Court, he was appointed on a Committee, to view the linen, the growth of the Province. Mar. 9, 1724-5, the Committee on flax reported £15 worth. Nov. 22, 1706, the town paid him £15 15s. for serving the General Court 105 days; i. e. 3s. per day.
- [37.] Jonas Bond, Jr., Esq., was selectman 24 years, 1730-1766.
- [40.] Aug. 21, 1716, William Bond and wife Hepzibah sold to son Samuel Bond 96 A. in Weston, bounded E. by Wat. line, W. by Joseph Peirce, N. by line between Weston and Lex., S. by Daniel Estabrook. This was in that part of Weston, which was taken off to form a part of the town of Lincoln.
- [42.] Mrs. Mary (Bond) Mead, d. Jan. 20, 1780, aged 52.
- p. 50. [46.] Dec. 13, 1717, William Bond and wife Hepzibah, conveyed to son William ½ acre of land in Wat., bounded S. by highway, N. E. by Thomas Learned, N. and W. by William Bond. This was between, what was formerly Learned's tavern, now the Spring Hotel, and the residence of the late Col. Amos Bond. He sold this to his brother Nathaniel; and June 13, 1721, for £183, bought of Samuel Robinson, of Cambridge, a house and one acre in Camb., bounded N. E. by Wat. Road, S. W. by Brattle's land, N. W. by way to Brattle's land, S. E. by the Common. Also 2 A. in cow commons, in undivided land, formerly of Samuel Green. Feb. 2, 1724-5, he, "of Camb.," for £200, sold said house and ½ acre to William Brattle. His son William, bap. Jan. 19, 1723-4, was probably born while he resided in Cambridge.

- [49.] The Inventory of Daniel Bond, dated Jan. 9, 1756. Mar. 18, 1723-4, Daniel Bond, for £120, bought of John Philips, maltster, of Wat., 17 acres, bounded E. by Benjamin Whitney, S. by Simon Tainter, W. by highway, N. by wid. Mary Phillips' thirds.
- p. 51. [88.] Ap. 28, 1710, Nathaniel Bond, of Wat., for £85, sold to Daniel Benjamin, a house and 24 acres, bounded E. by heirs of John Whitney, N. by John Bond (his brother), Benjamin Eddy, and highway, W. by John Bond, and Beaver Brook, S. by Joseph Priest. Also, marsh in Camb., bounded E. by Dea. Wm. Bond, W. by Daniel Benjamin, S. by Abraham Jackson, N. by Charles River. This sale was made a short time before he went to Canterbury. It may be observed, that the first of these lots corresponds partly with that sold by Wm. Bond, Esq., to his son Nathaniel, father of this Nathaniel. Ap. 17, 1711, Nathaniel Bond, of Canterbury, Conn., for £35, sold to Joseph Waite, 90 acres in Wat. (Weston), bounded N. by Camb. line, E. by Joseph Peirce, S. by John Wellington, W. by Thomas Waite. This may have been that farm land which Wm. Bond, sen., sold to his son Nathaniel. See [31] above.
- p. 52. [98.] For the lineage of Ruhamah, 2d wife of John Bond, see Locke Family, p. 34.
- [101.] Joshua Bond went to Concord, in the spring of 1768.
- [115.] Elijah Bond, was selectman 1774, 75, 76, 77, and in 1775 he is designated as "Esquire." About 1754, he and his brother, Jonas, became members of Christ Church, in Boston.
- p. 53. [123.] For Frask, read Trask.
- [125.] William Bond, of Weston, was on the Alarm list, 1757. Was it this William, or [?] 71? Was he the William Bond, who belonged to Capt. Charles Prescott's troop of horse in 1757?
- p. 54. [143.] Strike out all between Gray, and, she d. Oct., &c.
- [159.] Abraham Bond, was a soldier in the public service, Aug. 1, 1757. He m. in Westboro, (pub. Ap. 3,) 1753, Submit Joslyn. He m. (2d), (pub. May, 18), 1762, Dinah Forbush.
- [160.] John Bond, m. Sarah Rice, Feb. 16, 1792.
- p. 55. [162.] William, m. in Westboro, Nov. 24, 1796, Joanna "Lenord."
- [163.] Joseph, m. Nov. 24, 1804, Lucy Ball.
- [164.] Hannah, m. Oct. 18, 1795, Joel Parker.
- [171.] Dea. Jonathan Bond, did not take a dismission from Wat., until he left Mendon, and settled in Westboro, Feb. 23, 1752, when he was adm. f. c., in Westboro, from Watertown; and the same day his wife, Mary, was adm. f. c., from Mendon. He was Lieut. in Capt. Benjamin Wood's company, from Aug. 9, to Dec. 13, 1755. He and his son, Jonathan, belonged to Capt. Flagg's Co., in (?) 1757.
- [172.] Mary, m. June 20, 1753, Aaron Warren.
- p. 56. [181.] Mrs. H. Bond, d. in Clinton, Oneida Co., N. Y., Dec. 9, 1853.
- [191.] Aug. 1, 1757, Thomas Bond, enlisted in Capt. Fay's Co.
- [192.] Elizabeth, m. Nov. 4, 1790.
- [+1934.] Lucy, b. July 17, 1793.
- [+194.] For Landman, read Lanman. Dr. DANIEL GILBERT, m. (1st.) Jan. 17, 1826, SUSAN LANMAN, b. Aug. 1, 1807, d. Aug. 5, 1831. He m. (2d) Oct. 29, 1833, A. S. RIDGWAY, b. Feb. 14, 1804. Chil.,
1. *Augusta Goldthwaite*, b. Nov. 17, 1826, m. Jan. 2, 1850, *Samuel F. White*.
 2. *Helen S.*, b. Ap. 2, 1835. 3. *Ada Ann*, b. Aug. 8, 1836.
 4. *Daniel D.*, b. Dec. 23, 1838.
- [+195.] THOMAS GILBERT, m. Dec. 9, 1830, JULIA ANN DENNY. Chil.,
1. *Catherine*, b. June 1, 1832. 2. *Wm. Austin*, b. Ap. 18, 1834.
 3. *Elizabeth*, b. Nov. 28, 1837, d. Jan. 8, 1839. 4. *Elizabeth*, b. Oct. 16, 1839.
 5. *Lucy*, b. Jan. 14, 1842. 6. *Thomas B.*, b. Sept. 3, 1844, d. Feb. 5, 1846.
 7. *Daniel*, b. Feb. 1, 1847. 8. *Thomas Newton*, b. May 21, 1849.
- p. 57. [193.] Dr. Josiah Bond, d. Jan. 1853, aged 85.
- [205.] For 1733, read 1833.
- [214.] 2. Elizabeth Jenks, b. Ap. 2, 1848.
- p. 58 & 59. [230.] Rev. William B. Bond, now (1853) of St. Johnsbury, Vt., m. (2d) Sept. 10, 1851, Eudora R. Parsons, of Enfield, Conn.
- [231.] George T. Bond, m. in June, 1854, Anna L. Dodd.
- [240.] Mrs. Sarah (Haskill) Sturtevant, d. Jan., 1853.
- p. 60. [258.] Harriet Eliza Bond, m. Jan. 12, 1853, Addison Lincoln, of Templeton.

- [262.] Eunice Bond, m. in Westboro (pub. Jan. 3), 1761, Barnabas Newton.
- [263.] Joseph, m. Ap. 3, 1766, Hepzibah Pratt.
- [264.] Martha Bond, m. (pub. Feb. 16), 1788, Stephen Bathrick.
- [264½.] Rachael Bond, m. Feb. 18, 1790, Abner Warren.
- [266.] (?) Record says, Hannah Bond, m. Oct. 18, 1795, Joel Parker.
- [271.] Lydia Bond, m. July 24, 1767, Moses Wheelock.
- [272.] Lucy Bond, m. (or pub.) Dec. 8, 1774, Timothy Parker.
- [273.] (?) Henry Bond, was on the Alarm list of Weston, in 1757.
- p. 62. [322.] Amos Bond, was selectman 1758, 59, 60. His eldest son, Amos, d. May 21, 1748.
- [324.] Col. Amos Bond, Esq., was selectman of Wat. 21 years, 1782 to 1809.
- [326.] LEVI THAXTER, Esq., m. (2d) Lucy, dr. of Jonas White [28.]. Chil., by 2d wife :
 1. *Jonas White*, b. Oct. 25, 1814, d. Oct. 14, 1815.
 2. *Lucy White*, b. Jan. 31, 1818, d.
 3. *Jonas White*, b. Feb. 27, 1820, grad. Harv. Coll. 1838.
 4. *Mary Lincoln*, b. May 10, 1822, m. Samuel Jennison, Jr., of Worcester, grad. Harv. Coll., 1829.
 5. *Levi Lincoln*, b. Feb. 1, 1824, grad. Harv. Coll., 1843.
- p. 65. [368.] Charles Royal Bond, now (1853) of California, m. a daughter of Joseph Adams, of Boston.
- p. 66. [391.] For 1824, read 1823.
- p. 67. [406.] For Jane (Newell), read Jane (Noble).
 [407.] Henry Bond Dewey, Esq., U. S. Consul for the Port of Para, Brazil, m. Sept. 2, 1854, Donna Luiza Calandrini da Silva Pacheco, of that city.
- p. 68. [423.] Mr. Linus Homer, d. Dec. 23, 1853, aged 71.
 [429.] Harriet E. Homer, m. Mar. 20, 1854, Samuel D. Arnold, of Sturbridge, and settled in Cleveland, O.
 [432.] Capt. Charles Bond, Assessor of Wat., 1800, 1, 2, 3, 5, 6, and selectman, 1804, 5, 6.
- p. 69. [436.] Rev. Daniel Bond, d. in Peekskill, Aug. 20, 1852.
- p. 70. [451-3.] Joseph Davis Bond, d. July 7, 1820.
- p. 72. [483.] Emery Bond, d. Ap. 18, 1851.
 [497-1.] For Esther read Estes, b. 1806, m. in Brimfield, May 15, 1851, Maria Barron.
 [498.] Jonas Bond, belonged to Capt. Solomon Holmes' Co., of Sutton, which marched Aug. 18, 1757, for the relief of Fort William Henry.
- p. 76. For 3. 6 (margin) read 2. 6.
- p. 79. [30.] See p. 672, Wyman, 69.
-
- p. 87. **BOURDEN.**—For adm. freeman, read, took oath of fidelity. Feb. 20, 1657, Charles Chadwick, at Court, discharged John Bourden. William Bourden (? of Wat.), aged 31, was among Wat. witnesses at Court, Mar. 24, 1656-7.
-
- p. 88. **BOWMAN.**—[1.] Hannah Bowman was a witness in Court in 1678, then aged 63, showing that she was born about 1615. This was perhaps Anna, wife of Nathaniel Bowman. In 1652, Nathaniel Bowman and wife Anna executed a deed, when he signed his mark and she wrote her name.
 [2.] For adm. freeman, read, took oath of fidelity.
 [3.] Nathaniel Bowman was a witness in Court in 1662, then aged "about 30" (? 20). In 1669, he, then of Wethersfield, had married Rebecca, dr. of Rev. Henry Smith, of Wethersfield, who had been deserted by, and divorced from, her former husband, Samuel Smith, of New London. [Caulkins, p. 151.] Perhaps he was the father of that Nathaniel, an unmarried man, who d. in Wethersfield in 1707.
 [4½.] Dorcas, wid. of Benjamin Blackleach, m. May 29, 1676, Hugh March, of Newbury, his 2d wife. She d. Nov. 22, 1683.
 [6.] For Angiers, read Angier. By a deed, executed Dec. 1, 1715, conveying to Dea. Benjamin Brown, 110 acres of land, late of Dea. Samuel Stone, of Lex., it appears that Esq. FRANCIS and LYDIA BOWMAN, had the following chil., then living, viz. :—
 1. *Francis*. 2. *Lydia*. 3. *John*. 4. *Mary*.
 [7.] John Bowman and wife Mary, adm. f. c. Lex., June 22, 1718.
 [8.] (?) John Bowman, had son John bap. in Lex., July 15, 1759.
 [9.] Jonas Bowman, o. c., Lex., June 17, 1739.
 [9-2.] Rodolphus Carver was a son of Eleazer, Jr., and Katherine, and after m. he lived in Oakham. [See Mitchell, p. 129.]

- [10.] See Smith. [37-8.]
 [11.] Ebenezer Bowman had dr. Abigail bap. in Lex., May 27, 1750.
 [13.] The parentage of this Isaac Bowman, Esq., has not been ascertained. He and wife Elizabeth were adm. f. c., Lex., Feb. 18, 1727. He d. July 18, 1785, aged 92, and his wife Elizabeth d. Ap. 13, 1785. It was probably their son Isaac, who m., Feb. 27, 1752, Sarah Munroe, and had son Francis, b. in Lex., Nov. 26, 1752.
 [15.] Ap. 19, 1724, Anne, wife of Nathaniel Bowman, of Camb. and wid. Ruth Bowman [20.] were adm. f. c. in West Precinct (Waltham). Capt. Nathaniel Bowman and wife were buried in the Waltham graveyard.
 p. 89. [21 & 22.] Grace and Sarah Bowman, o. c. in W. Precinct (Waltham), Mar. 13, 1726.
 [24.] Joseph Bowman was a captain and magistrate.* His wife Phebe d. Dec. 20, 1751, aged 79.
 [25.] See below.
 [27.] James Bowman and Abigail Russell, m., in Lex., Mar. 19, 1738-9.

[25.] (IV.) JOSEPH BOWMAN, of Westboro, eldest son of Joseph B., Esq. [24], m., in W., Mar. 16, 1731-2, THANKFUL FORBUSH. Chil.,

34. 26 1. JOSEPH, b. Jan. 21, 1734-5, grad. Harv. Coll. 1761.
 27 2. LYDIA, b. July 19, 1736; m. in Westboro, Aug. 24, 1758, SOLOMON MATTHEWS, of Petersham.
 49. 28 3. JAMES, b. Dec. 25, 1736. 4. WILLIAM, b. Mar. 5, 1742.
 30 5. FRANCIS, b. June 19, 1744. 6. PHEBE, b. May 7, 1747.
 32 7. PHINEAS, b. Ap. 18, 1750, grad. Harv. Coll. 1772, then said to be of Oxford, where his brother Joseph then resided.
 33 8. THANKFUL, b. Ap. 17, 1753.

26. 34 (V.) Rev. JOSEPH BOWMAN, grad. Harv. Coll. 1761; ordained (sermon by Charles Chauncey, D.D.), in the Old South Church, in Boston, Aug. 31, 1762, as a missionary to a tribe of Indians, at Onohoquaque, on the Susquehanna, whither he soon departed. He returned in the spring of 1763 in order to be married, with the intention of settling permanently among the Indians. He was proceeding thither with furniture and provisions, when the outbreak of Indian hostilities interrupted his progress, and the Mission failed. Upon his return, after preaching a short time in Westboro, he went to Oxford, Mass., where he was ordained, Nov. 14, 1764. He resigned this charge, Aug. 28, 1782, and in Mar., 1784, moved to Barnard, Vt., where he was installed, Sept. 22, 1784, the first, and until his decease, the only Cong. minister in that town. He was a trustee of Dart. Coll. from 1801, until 1806. He, then "of Onohoquaque," m., in Westboro, June 29, 1763, LAVINIA BAKER, a sister of Joseph Baker, the proprietor and one of the first settlers of Bakersfield, Vt. - He d. Ap. 27, 1806, aged 73, and his wid. d. Sept. 28, 1816. His chil., all b. in Oxford:

- 35 1. JOSEPH, sometime a merchant of Barnard; afterwards moved to Gardner, Me. He m. FRANCES SPOONER, sister of Judah P. Spooner, of Windsor, Vt. He had three sons and one dr. One son d. in Barnard; the other two, *Edward* and *James*, went to Gardner and engaged in trade. Edward d. unm.
 38 2. JOHN, m., in Barnard, MARY, dr. of Stewart Southgate. He moved to —, N. Hampshire, where he d. Jan. 24, 1847. He had one child, *Hiram*, who d., aged 28, unm.
 39 3. OLIVER, m. at Fairhaven, Vt., Jan. 3, 1800, DEBORAH SPOONER, b. in New London, Conn., Feb. 1777, dr. of Judah Paddock and Deborah (Douglass) Spooner. He died early, leaving one child, and his wid. m. Andrew Leach, Esq., of Pittsford, Vt.
 40 1. Maria D., b. Sept. 30, 1800, at Vershire, Vt., m., Sept 15, 1830, Rev. *Walter Follett*, b. in Worcester, Mass., Jan. 7, 1799, grad. Mid. Coll., 1825, And. Theol. Sem., 1829; pastor of a Cong. church, in Southboro, Mass., and afterwards in Temple, N. H.
 1. Maria Bowman, b. in Southboro, Sept. 1, 1831.
 2. Walter Julian, b. in S., July 31, 1833.
 3. Andrew Leach, b. in S., Mar. 3, 1835.

* He had an illeg. son, *Joseph Bowman*, by R. J., b. in the autumn of 1696, (?) who m. in Newton, in 1720, *Hannah Eutter*.

4. Herbert Edwards, b. in S., Feb. 26, 1837.
 5. Harriet Louisa, b. in Dudley, Mass., June 15, 1840.
- 41 4. POLLY, b. 1778; many years devoted to the care of her aged parents; m. Jan. 7, 1817, Major ELISHA SMITH, of Pomfret, Vt., his 2d wife. She died, Oct. 2, 1851, aged 74, s. p., much respected and beloved for her Christian virtues.
 5. A daughter, d. in infancy.
- 42 6. ALEXANDER, b. June, 1772, m. Mar. 1802, SARAH ANTHONY, dr. of John Anthony, Esq., formerly of Newport, R. I., afterwards of Sherburne, Vt. He settled on his father's homestead, in Barnard, where he d. Dec. 25, 1813. [John Anthony, was a brother of Joseph Anthony, formerly a wealthy merchant of Philadelphia, who d. of yellow fever, in 179-, leaving a wid. and an only child, Patty (Martha), who m. John Pollack, John Anthony's eldest son. John P., a shipmaster, m. the youngest daughter of Rev. Dr. Samuel Hopkins, of Newport, afterwards of Hadley.] Chil.,
- 43 1. William, b. Dec. 15, 1802, m. Feb. 7, 1839, *Mary Ann Hathaway*, b. in Rome, N. Y., dr. of Joshua Hathaway, formerly of Bennington, Vt. He settled first in St. Lawrence Co., N. Y., where he was colonel of a Rifle Regiment. In 1837, he moved to Sugar Creek, Walworth Co., Wis., where he is a seedsman, and has held numerous respectable and highly responsible civil appointments. Chil.,
- 44 1. Charles Wilson, d. aged 2 yrs. 2. William Arthur, b. 1843.
 2. George, b. Mar. 6, 1805, m. *Eliza Reed*, of Rutland, Vt., and settled as a merchant in Milwaukee, Wis., Chil., 1. Mary Eliza. 2. Sarah Martisia.
- 45 3. Charlotte Emily. 4. Helen Francis. 5. Elbert George.
 3. Joseph, b. July 27, 1807; of Barnard, deputy sheriff, and afterwards justice of the peace; m. *Asenath Burroughs*, b. in Tunbridge, Vt., Jan. 27, 1815. Chil., 1. Joseph Anthony, b. June, 1837. 2. George Alexander, b. June, 1839. 3. Edward Morris, b. July, 1848.
- 46 4. *Mary Ann*, b. June 9, 1809, m. Nov. 25, 1830, *David Chandler*, of Pomfret, Vt. Chil.,
1. Alexander Bowman, b. July 14, 1831.
 2. Sarah Frances, b. Mar. 7, 1834. 3. Edward Aiken, b. Sept. 16, 1836.
 4. Ellen Stearns, b. Feb. 26, 1839.
 5. Mary Elizabeth Smith, b. July 4, 1841.
 6. John Herbert, b. Nov. 23, 1844. 7. Harriet Lucetta, b. May 21, 1849.
- 47 5. *Harriet C.*, b. June 15, 1812, m. Dec. 1830, *Edward Morris*, proprietor of large mills, on White River, in Hartford, Vt. Chil.,
1. Harriet Lucetta, b. Dec. 31, 1831, destroyed by quackery, aged 17.
 2. Sarah Pamela, b. Oct., 1837. 3. Delia Spellman, b. 1840.
 4. Mary Converse, b. Sept. 1842. 5. Edward Crosby, b. June, 1844.
- 48 7. GEORGE, supposed to have been lost at sea.
-
28. 49 (V.) JAMES BOWMAN, of Westboro, m. in Westboro, July 18, 1760, MARY GASHIT. They were adm. f. c., Sept. 26, 1761. She d. Feb. 16, 1827.
- 50 1. BENJAMIN, b. June 20, 1761, of Westboro, m. Nov. 15, 1786, ABIGAIL WHEELOCK. She d. Ap. 20, 1801. He m. (2d) Mar. 2, 1806, LUCY WHITNEY.
- 51 1. *Josiah Brigham*, b. Nov. 25, 1787.
- 52 2. *Daniel*, b. Sept. 5, 1789. By wife *Betsy*, had,
- 53 1. Joanna Elizabeth, b. May 9, 1817, m. Luther Bixby, and d. Oct. 19, 1850.
 2. Sarah Freeland, b. Nov. 7, 1819.
- 54 3. *Susannah*, b. Ap. 5, 1793.
- 55 2. LYDIA, b. Jan. 8, 1763, m. (pub. Ap. 15), 1781, JONA. PERCE.
- 56 3. NATHANIEL, b. Ap. 3, 1764, of Westboro, m. (pub. Sept. 9), 1791, MARY SCOTT. He d. June 16, 1835, aged 71; and his wid. d. Aug. 18, 1837, aged 70.
- 57 4. MOLLY, b. Sept. 20, 1766, m. (pub. Feb. 27), 1790, DANIEL HOLBROOK, of Fram. (See Barry.)
- 58 5. WILLIAM, b. Mar. 3, 1768.
- 59 6. JAMES, b. Nov. 9, 1770, m. Ap. 24, 1803, LEVINA FORBES.
- 60 1. *Eliphas*, b. Sept. 12, 1803.
- 61 2. *Elmer*, b. Mar. 7, 1805, m. Mar. 20, 1831, *Lovrenia Forbes*.
- 62 1. Abby Louisa, b. May 12, 1832. 2. Elijah Forbes, b. Aug. 12, 1835.

- 63 3. *Gilbert*, b. Dec. 7, 1806. 4. *Sally*, b. Dec. 11, 1808. 5. *Eliza*, b. Feb. 23, 1810.
- 66 7. *SIMEON*, b. Mar. 3, 1772.
- 67 8. *THANKFUL*, b. Nov. 7, 1774, pub. Feb. 28, m. May 29, 1793, *LEVI BALL*.
- 68 9. *PHEBE*, b. Mar. 3, 1776, m. (pub. Mar. 26), 1800, *JAMES MOULTON*, of Hopkinton.
- 69 10. *JOSEPH*, b. Mar. 22, 1778, by wife, *ANNE*, had 1. *Elizabeth*, b. May 25, 1807.
- 70 11. *LEVI*, b. Mar. 12, 1780, m. ———. Chil.,
- 71 1. *Caroline*, b. Mar. 3, 1799, m. about 1821, *Nathaniel Fisher*.
- 72 2. *Heriot*, b. May 26, 1802.
- 73 3. *Russell*, b. July 20, 1804, m. *Alona* ———. Chil.,
1. *George Russell*, b. Oct. 10, 1830. 2. *Charles Gale*, b. Ap. 24, 1833.
3. *Emily Elizabeth*, b. Aug. 3, 1835. 4. *Eleanor Alona*, b. June 23, 1838, d. 1839. 5. *Leonard Wellington*, b. Mar. 25, 1840.
- 74 4. *Charlotte*, b. June 9, 1806.
- 75 5. *Emery*, b. June 25, 1808, m. (pub. Oct. 1), 1832, *Susan Wellington*, of West Boylston. Chil.,
1. *Charlotte*, b. Feb. 8, 1834. 2. *Emory Reed*, b. Mar. 24, 1835.
3. *Susan Louisa*, b. Sept. 13, 1836. 4. *Harriet Augusta*, b. Dec. 24, 1837.
5. *John W.*, b. Dec. 27, 1838. 6. *Lucy Ann*, b. May 13, 1841.
7. *Sarah E.*, b. Aug. 11, 1844.
- 76 12. *HANNAH*, b. Nov. 4, 1782, m. May 12, 1805, *ELIJAH BURNAP*, of Hop.
- 77 13. *ELIJAH*, b. July 5, 1784, (?) m. *LUCY A* ———.
1. *Henry Augustus*, b. July 10, 1839, d. Ap. 26, 1843.
- 78 14. *SOPHIA*, b. May 25, 1785.
- 79 15. *LEVINAH*, b. May 4, 1787, m. May 22, 1808, *JOHN BALL, Jr.*
-
- 81 (IV.) *REV. JONATHAN BOWMAN*, b. Feb. 23, 1703-4 [See 28, p. 89]. Grad. Harv. Coll., 1724, ordained in Dorchester, Nov. 5, 1729; m. 1731, *HANNAH*, dr. of *Rev. John Hancock*, of Lexington. He was dismissed from his pastoral charge Dec. 14, 1773, and d. Mar. 29, 1775. His wid. d. Aug. 7, 1785, aged 80.*
-
94. 82 1. *ELIZABETH*, b. Oct. 3, 1732, m. Jan. 9, 1752, *ELISHA TILESTON*.
- 83 2. *LUCY*, b. Sept. 18, 1734, m. Oct. 31, 1764, *EDWARD PRESTON*, a clothier, his 2d wife. He d. Mar. 23, 1793, and she d. Feb. 1796.
- 84 1. *Lucy*, b. Jan. 23, 1769, m. Jan. 23, 1792, *Jonas Tolman*, a cordwainer, of Brookline. She d. Oct. 1799, and he d. June 13, 1826.
- 85 1. *Lucy*, b. Jan. 3, 1795, d. Oct. 27, 1815, unm.
120. 86 3. *JONATHAN*, b. Dec. 8, 1735, grad. Harv. Coll. 1755.
- 87 4. *MARY*, b. Jan. 8, 1737, d. Jan. 25, 1815, unm.
- 88 5. *EBENEZER*, b. Nov. 22, 1740, d. Ap. 1, 1741.
159. 89 6. *LYDIA*, b. Dec. 16, 1741, m. Nov. 30, 1769, *JAMES BAKER*.
- 90 7. *WILLIAM*, b. Jan. 8, 1744, grad. Harv. Coll., 1764; a lawyer, of Roxbury, m. June 5, 1777, *LUCY SUMNER*, b. June 29, 1751, dr. of Increase and Sarah (Sharp) Sumner, of Rox., and sister of Gov. Increase Sumner. He d. in Dorchester, Mar. 21, 1818. Chil., [See General Reg., viii. p. 128, n.]
- 91 1. *Jonathan*, b. Jan. 9, 1778, d. unm.
- 92 2. *William*, b. Aug. 31, 1782, d. unm. He was a captain in Col. Miller's Reg't., which so distinguished itself in the war of 1812.
- 93 3. *Henry*, b. May 9, 1786, d. unm.
-
82. 94 (V.) *ELISHA TILESTON*, a wealthy farmer, of Dorchester, m. Jan. 9, 1752, *ELIZABETH*, eldest child of *Rev. Jonathan Bowman*. He d. Nov. 17, 1802, and his wid. d. Aug. 12, 1818, aged 86.
- 95 1. *ELIZABETH*, b. Mar. 13, 1753, m. June 10, 1777, *SAMUEL COOLIDGE* [Coolidge, 177]. He d. Feb. 28, 1790, and she m. (2d) May, 1802, Col. *MOSES COOLIDGE*, of Wat., brother of her first husband [Coolidge, 394]. Chil.,
1. *Elisha*, b. May 20, 1778, d. May 8, 1781.
2. *Thomas Tileston*, b. May 23, 1780, d. May 23, 1783.

* For the materials for this genealogy of the family and descendants of *Rev. Jonathan Bowman*, of Dorchester, we are indebted almost exclusively to Mr. Edmund J. Baker, of Dorchester, a great grandson [168].

- 96 3. *Elisha*, b. Mar. 19, 1782. A dry-goods dealer, of Boston, m. Nov. 11, 1804, *Mary Cushing*, of Ashburnham. He d. May 21, 1806. Chil.,
- 97 1. *Mary Cushing*, b. Aug. 14, 1805, d. May 21, 1806.
- 97 2. *Elisha Tileston*, b. Nov. 4, 1806; a professor of music, m. Ap. 12, 1832, *Mary Ann Gould*, of Boston. Chil.,
- 98 1. *Mary Elizabeth*, b. N. Bedford, Feb. 11, 1834. 2. *Charles Lincoln*, b. in Bangor, Mar. 9, 1836, d. May 27, 1837. 3. Infant, b. and d. in Cincinnati, Aug., 1840.
- 99 4. *Ada*, b. in Cincinnati, Aug. 26, 1841. 5. *Henry Farnsworth*, b. in C., Jan. 8, 1844, d. July 31, 1849.
- 100 6. *Sarah Prichard*, b. in C., Jan. 8, 1846. 7. *Anna*, b. June 25, 1850, d. Ap. 15, 1851.
- 101 4. *Elizabeth Bowers*, b. Feb. 16, 1783, d. Ap. 1, 1784.
- 101 5. *Elizabeth Bowers*, b. Sept. 5, 1786, d. Mar. 25, 1813.
- 102 6. *Samuel*, b. Mar. 9, 1789, d. Sept. 20, 1807.
- 103 2. *MARY*, bap. Sept. 12, 1756, m. (1st) Dec. 3, 1777, *JOHN ROBINSON*. He d. Sept. 1782, and she m. (2d) 1785, *JOHN HUMPHREY*. She d. in Athol, Jan. 21, 1792.
- 103 1. *Clarissa* (Humphrey), b. Nov., 1789, d. May 6, 1792.
- 104 3. *THOMAS*, b. Nov. 20, 1758, m. 1790, *ELIZABETH WAIT*, of Roxbury. She d. Jan. 10, 1822, and he d. Ap. 28, 1840. Chil.,
- 105 1. *Thomas*, b. Jan. 25, 1793, d. Ap. 14, 1827, unm.
- 106 2. *Charlotte*, b. Dec. 14, 1796, m. Oct. 7, 1824, *Henry Wales*. She d. Feb. 1, 1827. 1. *Charlotte Elizabeth Agnes*, d. Mar. 27, 1827, aged 3 mos.
- 107 4. *LUCY*, b. Dec. 17, 1760, m. Dec. 9, 1790, *SAMUEL WITHINGTON*, of Dorchester. He d. Ap. 29, 1822, and his wid. d. Feb. 16, 1838, s. p.
- 108 5. *SARAH*, b. Ap. 5, 1763, m. June 29, 1786, *WILLIAM RICHARDS*. She d. Mar. 25, 1803, and he d. July 10, 1817. Chil.,
- 109 1. *Mary Cooper*, b. Mar. 29, 1787, d. Oct. 23, 1813, unm.
- 110 2. *William*, b. July, 18, 1788, d. July, 1817, unm.
- 111 3. *Lucy*, b. June 17, 1799, m. Jan. 20, 1820, *John Pettis*, a mail contractor, of Windsor, Vt. She d. May 27, 1849. Chil.,
- 112 1. *William Richards*, b. Oct. 20, 1820, d. soon.
- 112 2. *William Richards*, b. Oct. 7, 1821, m. May, 1846, *Helen Danilly*, of Tallahassee, Florida. She d. in childbed, in Windsor, June 7, 1847, aged 18 yrs. Son, *Elijah Richards*, b. May 30, d. June 6, 1847.
- 113 3. *Mary Elizabeth*, b. June 18, 1823, d. July 22, 1841.
- 114 4. *John*, b. Nov. 4, 1825. 5. *Frederick Dudley*, b. Sept. 28, 1827.
- 116 6. *Edward Curtis*, b. Aug. 3, 1829. 7. *Lucy Ellen*, b. Mar. 13, 1833.
- 118 8. *Robert Thaxter*, b. June 24, 1834.
- 119 6. *LYDIA*, b. Sept. 18, 1766, d. Oct. 4, 1814, unm.
-
86. 120 (V.) *JONATHAN BOWMAN*, grad. Harv. Coll. 1755. He was for many years Judge of Probate of Lincoln Co., Me., and held many other offices. He was elected a member of Congress for that district, but declined the office on account, it is said, of the prevalence of small-pox in Philadelphia. He m. (1st), Ap. 26, 1770, wid. *MARY EMERSON*, dr. of *Ebenezer Lowell*, of Boston. He m. (2d), Jan. 1, 1798, *MARY GOODWIN*. He d. in Dresden, Me., Sept. 4, 1804.
- 121 1. *JONATHAN*, b. Ap. 17, 1771; d. Aug. 21, 1808; grad. Harv. Coll., 1790; m. (1st), Sept. 1798, *LYDIA WOOD*, of Wiscasset, where he had settled as a lawyer. He m. (2d), 1806, *SALLY D. CLOUGH*. One child.
- 122 1. *Louisa Lydia*, b. Dec. 22, 1799; d. Mar. 11, 1828; m., July, 1818, *Benjamin Sewall*, a merchant, of Boston. One child.
- 123 1. *Louisa Bowman*, b. Dec. 11, 1821, m., Sept. 9, 1845, *Charles D. Hubbard*, a merchant, of Boston. Chil.,
- 124 1. *Louisa Sewall*, b. July, 1846.
- 125 2. *Mary*, d. Aug., 1849. 3. *Elizabeth Livermore*, b. 1849.
- 127 4. *Charles Wright*, b. Jan., 1851.
- 128 2. *WILLIAM*, b. Oct. 2, 1772, d. Sept., 1826; entered Harv. Coll., but did not graduate; was a lawyer of Wiscasset. He m. *PHEBE BRIDGE*. Chil.,
- 129 1. *Mary Lowell*, b. Mar. 8, 1802; m., Feb. 27, 1827, *James Johnson*, a farmer, of Dresden, Me. Chil.,
- 130 1. *Bowman Bridge*, b. Jan. 22, 1843.

- 131 2. *Edmund Bridge*, b. Aug. 29, 1804, grad. Bowd. Coll. 1823; settled first in Bowdoinham, as a lawyer; now (1853) resides in Dresden, Me., and is clerk of the Courts in Lincoln County. He m., Dec. 3, 1828, *Hannah D. Norris*. Chil.,
- 132 1. *Phebe Bridge*, b. Ap. 17, 1830; m. *William Clark*.
- 133 2. *Mary Helen*, b. Jan. 18, 1832. 3. *Edmund Bridge*, b. July 29, 1835.
- 135 4. *James Norris*, b. Oct. 2, 1837. 5. *Francis Payson*, b. July 4, 1840.
- 137 6. *Elizabeth Young*, b. Oct. 12, 1842. 7. *William*, b. Ap. 22, 1846.
- 139 8. *Thomas*, b. May 25, 1848. 9. *Jonathan*, b. Mar. 28, 1852.
- 141 3. *THOMAS*, b. May 20, 1774; d. June 3, 1837; grad. Harv. Coll., 1794; a lawyer, of Augusta, Me. He m., Nov. 3, 1799, *SALLY HOWARD*, of Augusta. His wid. d. Oct. 16, 1849. Chil.,
- 142 1. *Thomas*, b. Sept. 4, 1800; d. Dec. 7, 1818.
- 143 2. *Mary*, b. June, 18, 1803; m. May 25, 1825, *Llewellyn William Lithgow*, a trader, of Dresden, Me., s. p. He relinquished business, and retired to Augusta.
- 144 3. *Ocavia*, b. Ap. 19, 1805; d. Mar. 20, 1836, unm.
- 145 4. *William Albert*, b. 1807; d. Oct. 5, 1831, unm.
- 146 5. *Sarah Howard*, b. Mar. 30, 1809; m. (1st), Nov. 12, 1833, *Thomas Sherman*, M.D., Bowd. Coll., 1828, a physician, of Dresden. He d. in Augusta, Aug. 20, 1842; and she m. (2d), Sept. 1, 1847, *Edmund J. Baker*, Esq., of Dorchester, Mass. [See 168.] Chil.,
- 147 1. *Thomas Bowman* (*Sherman*), b. in Dresden, Aug. 10, 1834.
- 148 2. *Mary Lithgow* (*Sherman*), b., in D., Aug. 17, 1836; d. 1839.
- 148 3. *John Doane Welles* (*Sherman*) b., in D., Oct. 14, 1837.
(For chil. by 2d husband, see 169-70.)
- 149 4. *MARY*, b. Nov. 22, 1784, m., about 1800, *DR. SAMUEL PARKER*, of Wiscasset. She d. soon after, s. p.
-
89. 150 (V.) *JAMES BAKER*, of Dorchester; grad. Harv. Coll., 1760; was at various times a clergyman, a physician, and an apothecary; and, in 1780, commenced the manufacture of chocolate, so successfully carried on in the family to this day. He m., Nov. 30, 1769, *LYDIA*, the youngest dr. of *Rev. Jonathan Bowman*, of Dorchester. She d. July 26, 1816, and he d. Jan. 2, 1825.
-
- 151 1. *EDMUND*, b. Ap. 20, 1770; m. (1st), Sept. 21, 1791, *SARAH HOWE*. She d. Jan. 29, 1802, and he m. (2d), Oct. 5, 1803, *ELIZABETH*, wid. of Major John Lillie, and dr. of Daniel and Rachel Vose, of Milton. She d. Mar. 28, 1843, and he d. Oct. 11, 1846. He was a successful chocolate manufacturer, of Dorchester. Chil.,
- 152 1. *Walter*, b. July 28, 1792; grad. Harv. Coll., 1811; studied law, and afterwards engaged in the manufacture of chocolate, in which he amassed a large fortune. He is well known for his liberality to the poor. He m. (1st), Mar. 10, 1825, *Deborah Smith Mott*, of Boston. She d. while on a visit, at London, Dec. 13, 1838. He m. (2d), May 14, 1840, *Eleanor Jameson Williams*, of Boston. She d. May 7, 1852. Chil.,
- 153 1. *Walter*, b. Jan. 5, 1827; m., Aug. 15, 1851, *Frances Cordelia Kemlett*, and had *Florence Mott*, b. Aug. 15, 1852.
(By 2d wife.)
2. *Eleanor Williams*, b. Sept. 21, 1841; d. Mar. 28, 1845.
3. *Anna Gurney Buxton*, b. Nov. 30, 1843; d. July 11, 1846.
4. *Robert Williams*, b. Oct. 1, 1845; d. Nov. 6, 1846.
- 154 5. *Edith*, b. Jan. 8, 1850.
- 155 2. *Charles*, b. Mar. 26, 1795; d. May, 1830, unm.
- 156 3. *Horatio*, b. July 19, 1797; a farmer; m., Nov. 15, 1820, *Mary Atherton Southworth*, of Stoughton, and resided successively in Dorchester, Westford, Mass., and in Alstead, N. H., where he d. Ap. 20, 1845. Chil.,
- 157 1. *James Edmund*, b. Aug. 28, 1821; a farmer, of Preemption, Ill.; m., in Hinckley, O., Dec. 19, 1847, *Lucinda M. Gardiner*, b. in Middlebury, O. Chil.,
- 158 1. *Henrietta Almira*, b. May 20, 1849.
- 159 2. *Celia Emma*, b. Feb. 9, 1851. 3 dr. b. 1853.

- 161 2. Mary Southworth, b. Sept. 20, 1823; m., May 7, 1843, Henry Allen, a cordwainer, of Stoughton. He removed to Preemption, Ill. Chil.
- 162 1. Charles E., b., in Stoughton, Mar. 20, 1844; d. Ap. 29, 1846.
- 163 2. Charles H., b., in S., Aug. 18, 1846.
- 164 3. Jarvis, b., in Preemption, Ill., Jan. 25, 1849.
- 165 4. Foristall, b., in P., Jan. 7, 1851.
- 166 3. Marcus Southworth, a cordwainer, b., at Westford, Mass., Sept. 21, 1828; m. Ap. 25, 1847, Harriet Hansell, of Stoughton, s. p. They were divorced, Feb., 1853.
- 167 4. Horace, b., at Westford, Nov. 30, 1833; a cordwainer; m., Mar. 25, 1852, Susan C. Cole.
- 167 1. Edmund, b., in Stoughton, Nov. 12, 1852.
(By 2d wife, Elizabeth.)
- 168 4. Edmund James, b. Nov. 15, 1804; a gentleman farmer, of Dorchester; m., Sept. 1, 1847, wid. Sarah (Howard) Sherman. [See 146.] Chil.,
- 169 1. Lydia Bowman, b. Nov. 11, 1848.
- 170 2. Ellyn Lithgow, b. Feb. 16, 1851.
- 171 5. Lydia Bowman, b. Feb. 28, 1806; m., July 7, 1841, Rev. Benjamin Huntoon, of Canton, Mass., grad. Dart. Coll., 1817. She d. Oct. 2, 1844.
- 172 1. Daniel Thomas Vose, b. Sept. 4, 1842.
- 173 6. James Edmund, b. May 13, 1809; m., May 21, 1832, Martha Neale, of Portland, Me. He was a mariner, and d. at La Grange, Florida, Sept. 11, 1837. He had an only child, that d. early.
- 174 2. ELIZABETH, b. Dec. 20, 1774; d. May 2, 1805, unm.
- 175 3. LYDIA, b. Jan. 1, 1777; d. Dec. 27, 1851, unm.
-
- 176 (IV.) Capt. THADDEUS BOWMAN, Esq., of Lex. [Son of Capt. Joseph 31. and Phebe], b. Sept. 2, 1712, m. (1st) Dec. 2, 1736, SARAH LORING, b. about 1715, dr. of Dea. Joseph and Lydia Loring, of Lex. She d. Dec. 23, 1747, aged 33, and he m. (2d), Feb. 8, 1753, SYBIL WOOLSON, then of Lex., wid. of Isaac Woolson, of Weston. [Woolson, 16.] Her maiden name was Rooper, and it is probable that she was a dr. of Ephraim and Sybil Rooper (or Roper), of Sudbury. He d. in New Braintree, May 26, 1806, aged 93 years, 9 mos., and 7 days.
1. SARAH, b. Oct. 2, 1737, d. Oct. 3, 1742.
- 177 2. EDMUND, b. Aug. 4, 1739, m., (1st) May 8, 1760, ESTHER HOAR, of Lincoln. [Hoar, 33.] She d. July 22, 1780, and he m. (2d) (pub. Oct. 3), 1782, EUNICE MEAD, of Stow. He d. in Concord, Nov. 27, 1805, and was buried in Lincoln. His wid., Eunice, d. in Concord, Dec. 1806. He moved to Lincoln about 1765.
1. Edmund, b. in Lex., Aug. 14, 176—, d. Sept. 22, 1762.
- 178 2. Rebecca, b. in Lex., Sept. 8, 1762.
3. Sarah, b. in Lex., May 7, 1764, m. (1st) Capt. — Mills, who migrated from Massachusetts to Cincinnati, O. She m. (2d), a physician.
- 180 4. Rebecca, b. in Lincoln, Aug. 27, 1766. 5. Edmund, b. in Lin., Dec. 1, 1768.
- 182 6. Thaddeus, b. Sept. 22, 1771. 7. Rhoda (twin), b. Sept. 22, 1771.
- 184 8. Phebe, b. Sept. 24, 1773. 9. Sybil Roper, b. Aug. 10, 1776, d. Sept. 15, 1778.
(By 2d wife, Eunice.)
- 185 10. Ruth, b. Feb. 5, 1783, d. in Concord, Jan. 13, 1807.
11. Esther, b. Sept. 22, 1786.
185. 187 3. JOSEPH, b. Feb. 18, 1740—1, of New Braintree.
- 188 4. THADDEUS, b. Feb. 10, 1742—3, of Camb., m. Nov. 7, 1764, ELIZABETH LAWRENCE, b. Dec. 13, 1741, dr. of Jonathan and Elizabeth (Swain) L., of Lex. [J. Lawrence, 232, Part II.], had son Thaddeus, bap. in W. Camb., July 6, 1766. Thaddeus Bowman, and wife Elizabeth, were dismissed from Lex. Church, to Winchendon, May 26, 1776.
5. SOLOMON (twin), b. Feb. 10, 1742—3, d. June 6, 1744.
- 190 6. SOLOMON, b. June 2, 1744. A lieut. in the 25th Reg. of the Continental Army; in 1775, was in the battle of Bunker Hill, and was killed in the battle of Monmouth.
- 191 7. JOSHUA, b. Jan. 22, 1746—7, went to Wilkesbarre, Penn., thence to Ohio, and has descendants living on the Muskingum River.
(By 2d wife, Sybil.)
250. 192 8. SAMUEL, b. Dec. 2, 1753. 9. SARAH, b. July 4, 1755, d. soon.

260. 193 10. EBENEZER, b. July 3, 1757, grad. Harv. Coll. 1782, of Wilkesbarre.
 11. GIDEON, b. Sept. 30, d. Oct. 20, 1759.
- 194 12. LUCY, b. Jan. 21, 1761, m. in Waltham, June 17, 1790, Rev. RICHARD R. ELLIOT, of Wat., his 2d wife. [? He m. (1st) — Saltonstall.]
 13. SYBIL, b. Aug. 2, 1764, d. Dec. 2, 1765.
-
187. 195 (V.) Major JOSEPH BOWMAN (b. Feb. 18, 1740—1, 3d child of Capt. Thaddeus and Sarah (Loring) Bowman, of Lex.), m. in Lex., Nov. 22, 1764, KATHERINE MUNROE, b. Sept. 29, 1740, dr. of William, Jr., and Sarah (Mason) Munroe, of Lex. [See Mason, †18, and Locke fam., p. 308 and 9.] Soon after m., he moved to New Braintree, Mass. He was ensign of a company of 50 minute men, from the small town of New Braintree, who marched to Boston, upon the report of the Battle of Lexington. He soon after joined the army, and commanded a battalion at the Battle of Bennington, and other battles, which resulted in the capture of Burgoyne. He was in actual service one year, and afterwards muster master or recruiting officer. He d. Jan. 3, 1818, aged 76 y. 10 m. 7 d., and his wid. d. Ap. 30, 1824, aged 83 y. 6 m. 24 d. Chil.,
- 196 1. SARAH, b. in New Braintree, Oct. 18, 1765, m. July 12, 1791, PHILIP DELANO, of New Braintree. He d. about 1833, and she d. about 1843. Chil.,
 197 1. Joseph, b. Ap. 27, 1792, a ship-builder of Baltimore, m. *Mary Ann Mitchell*.
 1. Sarah Ann, d. 2. Julia, d. 3. Charlotte Susan, b. 1829, d. 1842.
 4. William Henry, b. 1833. 5. Philip, b. 1835.
- 198 2. *Cornelius*, b. July 27, 1794; a stage proprietor, of Northampton, Mass.; m. May, 1825, *Diana Phelps*. Chil.,
 199 1. Delia, b. Aug. 1827. 2. Susan, b. Jan., d. Oct., 1831.
- 200 3. *Henry Augustus*, b. May 31, 1796; a carriage-maker, and town clerk of New Braintree; m. 1846, *Louisa Waite*, of N. B.
 201 4. *Charles Wm. Frederick*, b. May 14, 1798, d. 1816.
- 201 5. *William Henry*, b. Sept. 27, 1800, of Boston, importer of oils and drugs; m. in Boston, 1825, *Susan C. Morse*. He d. Feb. 1841, on a voyage to Cuba, for his health. Chil.,
 1. Philip, b. 1827, d. 1829. 2. William, b. 1829, m.
 3. Susan, b. 1831. 4. Mary Porter, b. 1833. 5. Philip, b. 1835.
 6. Frederick, b. and d. 1837. 7. Julia Maria, b. 1839.
- 202 6. *Sarah Bowman*, b. July 14, 1803, of Springfield, Mass.
 203 7. *Frederick William*, b. July 18, 1806; a merchant, of Boston.
 8. *Augustus Frederick*, b. and d. June, 1808.
- 204 9. *Lucy Mattheus*, b. Mar. 15, 1810, m. July 4, 1832, *John William Bush*, of Hardwick, Mass. He d., and his wid. now resides in Springfield, Mass. Chil.,
 1. Wm. Delano, b. Aug. 1, 1835. 2. Charles Henry, b. June 7, 1839.
 3. Martha Dickenson, b. July 24, 1842.
- 205 2. CATHERINE, b. July 17, 1768, m. Nov. 17, 1787, Major JAMES WOODS, of New Braintree. He was a deacon of the Cong. Church, a delegate to the convention of 1780, "for forming a constitution for the state," and often Rep. in the State Legislature. She d. 1853, aged 84 y. 6 m. Chil.,
 206 1. *Samuel Stevens*, b. Oct. 27, 1788; a farmer, of N. B.; m. *Betsy Fiske*, of Holden, Mass. Chil.,
 207 1. Loring F., b. Dec. 10, 1810; m., and resides in Barre.
 208 2. *Matthew Finten*, b. June 25, 1813; a trader, of N. B.; m., Charlotte A. Lee, of Barre. He d. in Lancaster, Mass., 1853.
 1. Anna Lee, b. Jan. 24, 1839. 2. Harriet Elizabeth, b. Nov. 7, 1841
- 209 3. James, b. Ap. 22, 1815; a clergyman, now in California; m., in York District, S. C., in 1841.
- 210 4. Isaac Fiske, b. Nov. 6, 1819; d. in California, in 1853.
 5. Lucy Bowman, b. Dec. 31, 1826; d. 6. Anna, b. Nov. 26, 1829; d.
- 211 2. *Loring*, b. June 18, 1790; d.
 3. *Harding Penniman*, b. Ap. 23, 1792; merchant, of Barre; m. (1st), *Sally Caldwell*. She d. July 25, 1839, and he m. (2d), Sept. 1840, *Irene Dickenson*. Chil.,
 1. Edwin, b. Jan. 1, 1819. 2. Henry. 3. Harding. 4. Sarah.

5. Amory. 6. Catherine. 7. Joseph Bowman. 8. Harriet A.
9. Samuel F.
- 212 4. *James*, b. Sept. 9, 1794; a palm-leaf mattress-maker, of New Braintree; m. *Roxana Barr*, of N. B. Chil.,
1. John Field, b. Nov. 5, 1820. 2. Penelope, b. Jan. 5, 1823.
- 213 5. *Catherine Munroe*, b. Sept. 1, 1796; m., in 1817, *Seth Caldwell*, Esq., a farmer, of Barre. Chil.,
1. Charles, b. Jan. 18, 1819. 2. Catherine. 3. John, d. 4. Mary.
5. Seth. 6. James. 7. Caroline. 8. John.
- 214 6. *Isaac Bowman*, b. May 20, 1799; a farmer, of New Braintree; m. *Priscilla A. Barr*. He is d. Chil.,
1. Charles, b. Nov. 25, 1822. 2. John, b. June 4, 1825.
3. Lucy Bowman, b. Jan. 28, 1836; d. Feb. 25, 1837.
4. Mary, b. July 3, 1838.
- 215 7. *Anna*, b. Aug. 1, 1801; d.
- 216 8. *Caroline*, b. Jan. 8, 1804; m., d. 1853.
- 217 9. *Joseph Loring*, b. Jan. 7, 1806; a farmer, of New Braintree; m. Nov. 4, 1833, *Adaline Rice*, of N. B. Chil.,
1. Abigail Ann, b. Oct. 4, 1833. 2. Joseph, b. Oct. 15, 1835.
3. George, b. Ap. 10, 1838. 4. James, b. July 16, 1840.
5. Ellen Theodosia, b. Feb. 15, 1842.
- 218 10. *Edward Loring*, b. Oct. 4, 1808; a carriage-maker, of New Braintree; m. *Caroline Russell*.
- 219 3. **JOSEPH**, b. Sept. 10, 1771; of New Braintree. He was Rep. 14 yrs., 1807-1839; State Senator, 2 yrs. 1828-29; member of the Governor's Council, 3 yrs., 1832-34; member of the State Constitutional Convention, 1820. Having retired from mercantile business, in which he had acquired a competent estate, he was, in 1827, chosen President of the Hampshire Manufacturers' Bank, which office he held 21 years, by successive elections. He was very highly esteemed for his sound judgment, his moral and social virtues, and for his punctilious fidelity in the discharge of duties. He m. (1st), Nov. 26, 1797, *SALLY PENNIMAN*, b. in Mendon, Sept. 10, 1776, dr. of Henry and Experience Penniman, of New Braintree. She d. Mar. 28, 1843, and he m. (2d), Jan. 14, 1846, *Mrs. HANNAH B. D. LELAND*, of Grafton. He d. of lung fever, Jan. 30, 1852, aged 80 y. 4 m. 20 d. Chil.,
- 220 1. *Amory Haven*, b. Sept. 11, 1798; a colonel, and rep. 1832, and 33, of New Braintree. He moved to Rox., in 1837, and thence to New York, in 1840, where he is now a commission merchant. He m., May 7, 1827, *Mary Joslyn*, of New Braintree. She d. in Rox., June 19, 1837. Chil.,
1. Joseph Joslyn, b. Feb. 15, 1828. 2. Amory Haven, b. Oct. 11, 1829.
3. George Ripley, b. Oct. 6, 1831. 4. Mary Hawes, b. Dec. 6, 1833.
5. Harding Penniman, b. Aug. 28, 1835; d. Feb. 4, 1837.
- 221 2. *Louisa Wheelock*, b. Sept. 9, 1800; m., Aug. 6, 1828, *Henry M. Holbrook*, b. in Monson, Mass. In 1824, he engaged in mercantile business in Boston, and, having acquired a fortune, retired from business about 1847. He has been a Rep., and Alderman, and is now (1853), President of the Granite Bank. Chil.,
1. Lucy Bowman, b. June 28, 1832. 2. Henry Harding, b. Jan. 3, 1835.
- 222 3. *Lucy Penniman*, b. Mar. 19, 1803; d. Oct. 4, 1824.
- 223 4. *Joseph Harding*, b. Feb. 5, 1807; engaged in trade in Boston, in 1830, retired from business about 1848, and now resides in Brookline, m.
- 224 5. *Nehemiah Munroe*, b. May 19, 1809; d. July 21, 1841.
- 225 6. *Charles Delano*, b. Dec. 12, 1816; grad. Harv. Coll., 1838; was a family tutor in Georgia, until Nov., 1842, when he commenced the study of law with Judge Washburn, of Worcester; in Mar., 1845, was admitted to the Worcester bar, and soon after settled in Oxford, Mass. He m. Nov. 24, 1846, *Almira Louisa Jones*, b. in E. Windsor, Conn., Aug. 6, 1826, dr. of Elnathan and Almira Jones, of Enfield, Mass.
1. Louisa Jones, b. Feb. 10, 1849.
- 226 4. **ISAAC**, b. Dec. 27, 1773. He moved to Wilkesbarre, Penn., about 1795, where he soon acquired the confidence of the public, was elected Brigadier-General, and had many other offices of honor and trust conferred on him. He m., Ap. 9, 1806,

- MARY SMITH, eldest dr. of Obadiah Smith, of Wethersfield, Conn. He d. Aug. 1, 1850, aged 76 y. 7 m. 4 d. Chil.,
- 227 1. *Isaac Munroe*, b. Mar. 9, 1807; grad. Mil. Acad., West Point, in June, 1832; was a Lieut. of U. S. mounted rangers, and afterwards 1st Lieut. of dragons; d. at Fort Wayne, July 21, 1839.
- 228 2. *Horatio Blinn*, b. Oct. 11, 1809; a merchant, of Alton, Ill.; m., *Selina Rider*, b. Aug. 13, 1822, dr. of Capt. Simeon and Esther (Nickerson) Rider, of Chatham, Mass. Chil.,
1. Horatio, b. July 13, 1850. 2. Edmund Monroe, b. Aug. 26, 1852.
- 229 3. *Joseph*, b. May 29; d. Sept. 12, 1811.
4. *Francis Loring*, b. Aug. 27, 1813, of Wilkesbarre. In the Mexican war, he volunteered as a private, in the Wyoming Artillerists, was elected 1st Lieut., and afterwards Major of the 1st Regiment of Penn. volunteers; was in command of the left wing of the Regt., at the investment of Vera Cruz, received the first fire of the enemy, after the line of march was taken up, which was returned by his order; in the siege, at intervals, commanded the supporting party of the Navy Battery; commanded a battalion of his Regt., at the raising of the siege of Puebla, and at the battles of La Hoya, Huamantla, and Attixco. He is now a Major-General, in the Pennsylvania militia. He m. *Angelina Brobst*, grand-dr., of the late Christian Brobst, of Cattawissa.
- 230 5. *Samuel*, b. Oct. 31, 1818; m., May 19, 1845, *Sarah M. Titus*, b. Oct. 15, 1826, dr. of Theodore and Catherine Titus. Chil.,
1. Kate, b. Mar. 7, 1846. 2. Horatio, b. Sept. 20, d. Dec. 21, 1847.
3. Francis Munroe, b. Dec. 19, 1848. 4. Ella, b. June 22, 1850.
- 231 6. *Mary Louisa*, b. Dec. 31, 1821, unm. (1854).
- 232 5. LUCY, b. June 24, 1776; m. (1st), SAMUEL HALL, of North Brookfield. He d., and she m. (2d) ELISHA MATTHEWS, of New Braintree. He is d., and she d. Ap. 20, 1835, aged 58 y. 10 m. 26 d. Chil.,
- 233 1. *Paschal Piola (Hall)*, b. in North B.; d. in New Orleans.
- 234 2. *Samuel (Hall)*, b., in North B., Feb. 15, 1800; d. in Ohio.
- (By 2d husband.)
- 235 3. *John (Mathews)*, b., in New B., Ap. 23, 1803; now a farmer, in Worcester, Mass.; m., Dec. 14, 1827, *Mary Converse*, dr. of Col. Boswell Converse, of New B. Chil., b. in New B.,
1. Caroline, b. Ap. 6, 1829. 2. Frederick, b. Dec. 12, 1830.
3. Henry, b. Nov. 13, 1832; d. Dec. 24, 1833.
4. Lucy Hall, b. Jan. 17, 1834. 5. Henry Paschall, b. Feb. 20, 1836.
6. John Edward, b. Nov. 24, 1842.
4. *Increase (Mathews)*, b. Nov. 1810; d. soon.
- 236 5. *Hannah Snow (Mathews)*, b. Aug. 30, 1814; m. *Darforth Keyes Tufts*, a farmer, of New B. He d. 1852. Chil.,
1. William Keyes, b. June, 1839; d. Mar. 1840.
2. George Keyes, b. Oct. 17, 1841.
- 237 6. ANNA, b. Jan. 16, 1778; m., Nov. 17, 1799, JOHN FRINK HOYT, of New Braintree. He is d., and she d., June, 1851. Chil.,
- 238 1. *Faulkner Fordyce*, b. Oct. 15, 1800; d. Mar. 28, 1801.
- 239 2. *Mary Ayres*, b. Aug. 2, 1802.
- 240 3. *Gustavus*, b. Sept. 27, 1804, m.; d. May, 1835.
4. *Henry Augustus*, b. Sept. 14, 1806; a farmer, of New Braintree; m. (1st), June 12, 1833, *Abby Thompson*, b. June 22, 1814, dr. of Amos Thompson, of N. B. She d. Sept. 19, 1835, and he m. (2d), in 1844, *Nancy Russell*, of N. B.
5. *John Wyman*, b. July 15, 1809; d. Oct. 30, 1811.
- 241 6. *Elizabeth Ann*, b. Ap. 20, 1813; m., Sept. 14, 1837, *Stephen Mann Blake*, a bonnet manufacturer, &c., of Brooklyn, N. Y. Chil.,
1. Mary A. H., b. Dec. 1, 1838. 2. Charlotte Elizabeth, b. Jan. 1, 1841.
7. *Charles Delano*, b. Dec. 1, d. Dec. 10, 1816.
- 242 7. RHODA, b. June 30, 1780; m. Aug. 22, 1799, DR. JOHN FIELD, of Oakham, Mass., M. M. S. S. He d. (drowned) Aug. 28, 1813, aged 37. His wid. d., in Alton, Ill., 1840. Chil.,
- 243 1. *Charles Edwin*, b., in Oakham, Sept. 10, 1810, of Boston; m.
2. *Elizabeth Davis*, b., in O., May 31, 1802; d. Mar. 22, 1810.

- 244 3. *Spencer*, b, in O., Feb. 8, 1804; now of Barre; m.
 4. *John*, b., in Rutland, Mass., Jan. 17, 1806; d. June 3, 1809.
- 245 5. *Erasmus Darwin*, b., in R., Oct. 29, 1807; m.
- 246 6. *John*, b., in New Braintree, Nov. 12, 1809; of Worcester, m.
 7. *Jabez Upham*, b. in N. B., Nov. 3, 1811; d. Aug. 25, 1813.
- 247 8. *Harriet*, b., in N. B., Sept. 14, 1814; m., in 1837, *George W. Curtis*, a farmer, of Worcester. Chil.,
 1. Edward, b. 1840. 2. Harriet, b. 1842.
- 248 8. AVIS MUNROE, b. July 15, 1783; m. CALVIN HUNTER, of New Braintree. He is d., and she d., 1834. Chil.,
 1. *Lucinda*, b. Ap. 1808; d. Sept. 1810.
- 249 2. *Mary Ann Munroe*, b. Nov. 1810; m. *Royal Knight*, a trader, of New Braintree. Chil.,
 1. Avis Munroe. 2. Joseph Bowman.
-
192. 250 (V.) Capt. SAMUEL BOWMAN, enlisted at the outbreak of the Revolution, became a captain in the Continental army, and served until the close of the war. It is said that he was with Major André the night before his execution, and commanded the guard that led him to the gallows. He m., in Philadelphia, Nov. 3, 1784, ELEANOR LEDLIE, of Easton, Penn., whose parents were from Ireland. About 1789, he moved to Wilkesbarre, Penn., where his wife had a large land estate, to which he devoted his time. He d. June 25, 1818, and his wid. d. 1825.
1. MARIA, b., in Wat., Oct. 25, 1785; d. Ap. 18, 1786.
- 251 2. ANN, b. Mar. 15, 1788; d. at her uncle Rev. R. R. Elliot's, Sept. 29, 1798.
- 252 3. MARY, b. Jan. 15, 1791; of Wilkesbarre, unm. She spent several of her early years in the family of her Uncle Elliot.
- 253 4. ELIZA, b. Oct. 25, 1793, m., Sept. 14, 1822, CHARLES WHEELER, Esq., a lawyer, of Philadelphia, grad. Yale Coll., 1808. She d. May 23, 1848. Chil.,
 1. *Ellen*. 2. *Elizabeth Jones*. 3. *Charles*. 4. *Mary Bowman*.
 5. *Andrew Ledlie*. 6. *Annie May*.
- 254 5. WILLIAM LEDLIE, b. May 1, 1798; d. Mar. 15, 1848, unm.
- 255 6. SAMUEL, b. May 21, 1800; D.D. Geneva Coll.; rector of St. James's Church, in the city of Lancaster, Penn. He m. (1st) SUSAN, dr. of Samuel Sitgreaves, Esq., of Easton, Penn. She d. in 1830, and he m. (2d), in 1836, HARRIET CLARKSON, of Lancaster. She d. in 1852, s. p.
- 256 1. *Samuel Sitgreaves*, grad. Yale Coll., 1845; studied law in Philadelphia, and d. 1848, unm.
- 257 2. *Ellen Stuart*, unm. 3. *Susan*, d., aged 4 years.
- 258 7. ALEXANDER HAMILTON, b. Mar. 30, 1803; grad. at West Point Mil. Acad., in 1825; some time a professor in that Academy; now (1853) a captain in the U. S. corps of Engineers. He m. MARIE LOUISE COLIER, of Pensacola. Chil.,
 1. *Charles Stuart*. 2. *Mary Ellen*. 3. *Eulalia*. 4. *Louise*. 5. *Eliza Chase*.
 6. *Alexander Hamilton*.
- 259 8. ELLEN STUART, b. Oct. 25, 1805, m. Rev. JAMES MAY, son of Robert May, Esq., of Chester Co., Penn; grad. Jeff. Coll., 1823; D.D. Kenyon Coll.; some time rector of St. Paul's Church, Philada., now (1853) Professor of Church History and Pulpit Eloquence, in the Epis. Theol. Sem., Virginia, s. p.
 9. CHARLES, b. June 20, 1808; d. young.
-
193. 260 (V.) EBENEZER BOWMAN was in the battles of Lexington and Bunker Hill; grad. Harv. Coll., 1782; studied law with Samuel Sitgreaves, Esq., of Easton, Penn., and settled in Wilkesbarre, Penn., about 1789. It is stated in the minutes of sessions of Luzerne Co., that in 1794 Ebenezer Bowman and Putnam Catlin were then the only attorneys, and that Mr. Bowman had declined practice. He m., in New York, Nov. 10, 1796, ESTHER ANN WATSON, who was born in Ireland. He d. Mar. 1, 1829, aged 71, and his wid. d. July 21, 1848, aged 70.
- 261 1. CAROLINE, b. Aug. 12, 1797; m., in 1816, Hon. GEORGE DENNISON, Esq., of Wilkesbarre, some time member of Congress, a son of Col. Lazarus Dennison, who commanded the troops of Wyoming, on the day of the Massacre. She d. 1832. Chil.,

- 262 1. *George Bowman*, grad. Dick. Coll., studied theology, and d. 1843, unm.
 263 2. *Henry Mandeville*, grad. Dick. Coll., studied theology in the Epis. Theol. Sem., Va., and is now rector of a church in Williamsburg, Va. He m., in July, 1850, *Alice*, dr. of ex-president Tyler.
- 264 3. *Mary Watson*, d. Aug. 1842, aged 18 yrs.
 265 2. JAMES WATSON, b. Aug. 9, 1799; grad. at — Coll., studied law with his father, and settled in Wilkesbarre. He m., in 1825, HARRIET DRAKE, of Wilkesbarre, and d. in 1834. Chil.,
- 266 1. *George Drake*, an editor at Milwaukie, Wis.; m. in Binghampton, N. Y.
 267 2. *Amelia Watson*, m. *George Painter*, an editor at Muncy, Penn. She d. leaving one daughter.
 3. *Charles*, d. in infancy.
- 268 3. ANNA MARIA, b. Aug. 24, 1801; m., in 1825, Dr. DUDLEY ATKINS, son of Hon. Dudley Atkins Tyng, of Newburyport, afterwards of Boston; grad. Harv. Coll., 1816; M.D., Univ. Penn., 1820. He resided successively in Philadelphia, Wilkesbarre, and N. York city, and d. in 1845. Chil.,
- 269 1. *Sarah Elizabeth*, m. *William Draper*, a merchant, of Boston, now of N. York.
 270 2. *Caroline Bowman*, m., in 1853, *William Ries*, a native of Germany, merchant, of N. York.
- 271 3. *Mary Dudley*, m., in 1846, *John Coze*, son of Charles Coxe, formerly U. S. Consul at Tunis.
- 272 4. *George Tyng*. 5. *Thomas Astley*. 6. *Francis Higginson*.
- 275 4. LUCY ELLIOT, b. Oct. 12, 1806; m., Feb. 22, 1827, Dr. THOMAS WRIGHT MINER, son of Asher Miner, Esq., of Norwich, Conn. He passed two years, Sophomore and Jr., in Princeton College; M.D., Univ. Penn., 1825. She d. in 1842.
- 276 1. *Ebenezer Bowman*, b. 1829; grad. Columb. Coll., 1849; M.D., Univ. Penn., 1852; now of Wilkesbarre.
- 277 2. *Mary Ann*. 3. *Asher*.

p. 89. [41.] WILLIAM BOWMAN, was admitted to Lex. Church, Mar. 28, 1742, and was dismissed, Sept. 26, 1742, to Narraganset, No. 2 (Westminster). Was it this Wm. B., who m. MARY REED, in Lex., in 1753, and had 1. MARY, bap. in W. Camb., Mar. 17, 1754; 2. HANNAH, bap. in Lex., Jan. 4, 1756; 3. PHEBE, bap. Jan. 19, 1757; 4. BETSEY, bap. Oct. 10, 1761; 5. LYDIA, bap. Dec. 14, 1766?

280 (III.) SAMUEL BOWMAN, b. Aug. 14, 1679; d. 1746 [See p. 89, No. 44]; was a deacon, of Camb.; m. (1st) Nov. 21, 1700, REBECCA, dr. of Thomas Andrews [see Andrews]. She d. Nov. 18, 1713, and he m. (2d) DEBORAH WYETH, b. Nov. 20, 1686, dr. of John and Deborah (Ward) Wyeth, and grand-dr. of Nicholas and Rebecca (wid. Andrews) Wyeth, of Camb. She was also a grand dr. of John and Hannah (Jackson) Ward, of Newton, and a gr. grand dr. of William and Elizabeth Ward, of Sud., and of Edward and Elizabeth Jackson, of Newton. [See Ward Family.] His-estate was divided, Sept. 3, 1783, among the following heirs, viz., son SAMUEL; heirs of son NOAH; drs. REBECCA CHOATE, MARTHA CUTTER, DEBORAH KIDDER, and ABIGAIL WINSHIP.*

1. ANDREW, b. Oct. 15, 1701; d. Ap. 6, 1702.
 281 2. SAMUEL, b. Mar. 2, 1702-3; of Charlestown; m., Mar. 20, 1745-6, HANNAH FROST. His Will, dated June 11, and proved, June 21, 1783, mentions wife, and son Samuel, and appointed his brother Gideon Frost, ex'r. Chil.,
1. *Samuel*, b. Ap. 20, 1747. 2. *Edmund*, b. Feb. 6, 1748-9.
 3. *Hannah*, b. Feb. 6, 1750-1.
3. MARTHA, b. May 13, 1704; d. Dec. 1, 1713.
 285 4. MARY, b. Aug. 14, 1706, not mentioned in the division of her father's estate.
 286 5. REBECCA, b. Jan. 10, 1708-9; m. in Rox., Feb. 4, 1730, STEPHEN CHOATE.
 287 6. HANNAH, b. Ap. 2, 1711; (?) m. — WETMORE. She is not mentioned in the division of her father's estate.
 288 7. ANDREW, b. Ap. 27, 1713.

* At a general town meeting of the Proprietors, Freeholders, and Inhabitants of Natick, held May 4, 1719, *Samuel Bowman* was one of those voted unanimously to be "the only and true proprietors of Natick." [See Hist. of Natick, p. 29.] Was this an Indian of that name, or was it Dea. Samuel Bowman, of Cambridge?

(By 2d wife, Deborah.)

- 289 8. MARTHA, b. Feb. 10, 1714-15; m., July 17, 1739, NEHEMIAH CUTTER (? or Bridge).
 290 9. DEBORAH, b. May 30, 1716; m., Sept. 17, 1741, NATHANIEL KIDDER.
 291 10. NOAH, b. Oct. 23, 1718; d. 1782; m. (pub. July 14), 1744, HANNAH WINSHIP.
 b. Aug. 18, 1718, dr. of Daniel and Hannah, of Lexington. His Will, dated
 May 19, proved Oct. 2, 1782, mentions wife Hannah; grandson Nathaniel
 Bowman, living in his family and a member of College; nephew Samuel
 Kidder, and son-in-law, Nicholas Pike.
- 292 1. Hannah, b. Feb. 25, 1745; adm. f. c. 1763; m. Nicholas Pike, of Newbury-
 port, grad. Harv. Coll., 1766, A.A.S., well known for his valuable works on
 Arithmetic. She d. July 7, 1778, and he d. 1819.
- 293 2. Joshua, bap. Feb. 15, 1746-7; grad. Harv. Coll., 1766; was a Captain of
 Dragoons in the Continental Army, and died, shot from his horse, at
 Charleaton, S. C., Mar. 30, 1780. He m., in Wat., Ap. 27, 1767, Abigail
 Fowle [?]. He left an only child,
301. 294 1. Nathaniel, b. Mar. 18, 1768; grad. Harv. Coll., 1786.
 295 3. Elizabeth, b. Ap. 10; bap. May 1, 1748; d. Jan. 15, 1749.
 296 4. Andrew, b. Mar. 2, 1754, studied medicine with Dr. Kittredge, of Andover,
 settled in New Market, N. H., and d. in Camb. [gravestone], Feb. 9, 1777.
 297 5. Susanna, b. May 12, 1758; adm. f. c. 1777, and d. Nov. 28, 1778.
- 298 11. ELIZABETH, bap. May 7, 1721; d. Oct. 11, 1739.
 299 12. EUNICE, bap. Nov. 4, 1722.
 300 13. ABIGAIL, bap. Mar. 15, 1723-4; m., Dec. 30, 1755, WILLIAM WINSHIP, Jr.
 14. SUSANNA, bap. July 10, 1726; (?) d. unm.
-
- 294 301 (VI.) Dr. NATHANIEL BOWMAN, grad. Harv. Coll., 1786; studied medicine
 with Dr. Kittredge, of Andover, Mass., where he m., Oct. 1789, SARAH JOHNSON,
 dr. of Col. Samuel Johnson, of Andover. He settled in Gorham, Me., where he
 died of a casualty (the fall of a part of a steeple, at the raising of a meeting-
 house), June 8, 1797. His wid. Sarah is now (1855) living in Bath, Me., aged
 87. Chil.
-
- 302 1. SAMUEL GARDNER, b. Oct. 9, 1790, merchant, of Bath, Me., m. May 19, 1816,
 MARCIA STOCKBRIDGE, b. Ap. 7, 1795, dr. of William and Ruth (Bailey) Stock-
 bridge, of Hanover, Mass. [For her lineage, see Barry's History of Hanover,
 p. 388.]
- 303 1. Nathaniel, b. July 28, 1817, grad. Bowd. Coll. 1837, went to St. Francisville
 Parish, West Feliciana, La., was admitted to the N. Orleans bar in 1839,
 m., Mar. 9, 1842, Catharine Boer, of N. Orleans. He d. 1847.
- 304 2. Samuel Stockbridge, b. Aug. 27, 1818, educated a merchant; a cotton-
 planter of Tensas Parish, Louisiana; m. (1st), Jan. 1843, Sarah Hamilton,
 of W. Feliciana. She d. Ap. 1847, and he m. (2d), June 1851, Mrs. Eliza
 Hoover.
- 305 3. Ruth Elizabeth, b. Sept. 17, 1820; m. June 26, 1840, Lieut. Joseph Foster
 Green, U. S. Navy, of Charlestown, Mass.
- 306 4. William Stockbridge, b. Sept. 9, 1822, d. in infancy.
 5. William Henry, b. Nov. 18, 1823, a merchant, of Hicks Ferry, Tensas
 Parish, La.
- 307 6. Marcia Stockbridge, b. Feb. 9, 1826; m. Feb. 16, 1847, Nathaniel Coit Jenks,
 merchant, of Bath, Me.
- 308 7. Sarah Winter, b. Feb. 10, 1828.
 309 8. Frank Joshua, b. May 9, 1830, a merchant, of Bath, Me.
 310 9. Orville Richardson, b. Dec. 13, 1832.
 311 10. Howard Dorrance, b. Dec. 7, 1835.
- 312 2. SARAH, b. Nov. 19, 1792; m., May 10, 1814, SAMUEL WINTER, merchant, of
 Bath, Me., b. in Bath, 1789, d. Sept. 16, 1835. She d. Ap. 18, 1828.
- 313 1. Frank, b. Feb. 10, 1815; a merchant in the South, where he m., and d.
 Mar. 25, 1848.
- 314 2. Sarah M., b. Jan. 20, 1817.
 315 3. Wealthy J., b. June 7, 1819, m. in Clinton, La., Ap. 2, 1846, Thomas R.
 Patten, of Bath. He d. Mar. 1847, and she m. (2d), Oct. 7, 1850, Galen
 Clapp, of Bath. She d. Jan. 3, 1852.
- 316 4. William D., b. Oct. 28, 1820, grad. Harv. Coll. 1839; a lawyer; m. in

- Clinton, La., Mar. 30, 1844, *Lucretia B. Bass*. She d. Mar. 16, 1846, and he m. (2d) June 3, 1852, *Sarah M. Stirling*, of St. Francisville, La.
- 317 5. *Marcia Bowman*, b. June 28, 1824; m., Mar. 30, 1847, *John L. Anderson*, a civil engineer, of Portland, Me., son of the late John Anderson, of Portland.
- 318 6. *Harriet Augusta*, b. June 27, 1826; m. Sept. 4, 1851, *Richard B. Hill*, merchant, of Boston.
7. *Samuel*, b. Ap. 22, d. Aug. 16, 1828.
- 319 3. JOSHUA, b. Oct. 24, 1795, merchant of Bath, Me., m. Feb. 23, 1820, HANNAH FLAGG NORTH, b. Nov. 15, 1799, dr. of John and Mehitable (Trott) North, and granddr. of Judge Joseph and Hannah (Flagg) North, of Augusta, Me. He d. Sept. 2, 1823, and she d. Oct. 1, 1826. Chil.
- 320 1. *George Augustus*, b. Dec. 3, 1820, grad. Bowd. Coll. 1843; studied next three years in Princeton Theol. Sem., and the next year, 1846-7, in Bangor Theol. Sem.; ordained in South Cong. Church, of Kennebunkport, Me., Aug. 9, 1848.
- 321 2. *Caroline North*, b. Mar. 19, 1822, d. Nov. 28, 1846.

- p. 90. **BOYDEN**.—From the Woburn Town Records of 1700: "These 5 children of Thomas Bryden and Martha, his wife, were entered heer by their mother's request, because of thier removing too and frow in the Indian War. Some of them were never recorded anywhere else, and the rest of the records were lost."
1. *Martha*, b. June 14, 1667 (m. in Wob. Dec. 27, 1688, *Timothy Reed*).
2. *Elizabeth*, b. May 24, 1670. *John*, b. Nov. 29, 1672.
4. *Jonathan*, b. Sept. 27, 1675. 5. *Joseph*, b. Ap. 24, 1678.

BOYNTON.—EBENEZER BOYNTON was dismissed from Weston to Waltham, Nov. 30, 1735, rec'd at Waltham, Feb. 4, 1736; dismissed from Waltham to Hop., Oct. 31, 1737; received at Waltham from Hop., Jan. 8, 1744, and dismissed from Waltham to Mendon, Ap. 13, 1746.

Jeremiah Boynton and wife Patience, adm. f. c., Waltham, May 1, 1737, and they were dismissed to Mendon, Jan. 8, 1744.

Lois Boynton moved from Sud. to Wat., Dec. 4, 1753.

Mary, wife of Jacob Boyington, was from Lexington.

- p. 91. **BOYLSTON**.—[1.] For 1668, read Feb. 21, 1668-9.

It is evident, from the County Records, that THOMAS BOYLSTON, of Wat., was not a very exemplary husband or Christian, and that his friends in England had not full confidence in his prudence and discretion; as an agent was employed to purchase an estate for him in Watertown. It is not improbable that he had been a gay young gentleman of London, whose habits were not formed after the puritanical model, and, not being a member of the church, he was never admitted freeman.

Ap. 1650. Suit. Thomas Boylston vs. Thomas Pratt, for withholding money sent him by his uncle. John Sawin testified that in 1648, he spoke with the old man (the uncle), and he said he had assigned his house and lands in New England to him, Thomas Pratt [in trust] for young Boylston ["Boidson?"] and his children. Nonsuited.

[3.] Captain THOMAS SMITH, a butcher, of Charlestown, m., SARAH, 2d dr. of Thomas Boylston, of Watertown. She was adm. f. c. Charlestown, Aug. 26, 1668. She d. Aug. 18, 1711, aged 70 [gravestone]. Mar. 27, 1671, Thomas Smith, butcher, of Charlestown, for good cause, conveys by deed to "John Chinery, my father-in-law, and Thomas Boylston, my brother-in-law," the house in Charlestown, "where I now dwell;" the land and out-houses, and furniture, and all my lands, rights, and interest in Watertown; *In trust*, for behoof of Sarah Boylston, my wife and children, that I have by her. *In consideration*, they agree to pay his wife £20, and to discharge a debt he (T. S.) owes John Richards, a merchant of Boston. July 1, 1679, Thomas Smith, and wife Sarah, for £29, sold 10 acres of land in Wat., to Samuel and Joseph Allen. Chil.,

1. *Sarah*, b. July 22; d. Aug. 17, 1664. 2. *Thomas*, b. July 1, 1665.
3. *Wilham*, b. Mar. 24, 1666-7; m., *Abigail Fowle*. [Bright, 39.]
4. *Sarah*, bap. May 3, 1668. 5. *John*, b. Feb. 11, 1670.
6. Son, bap. Feb. 12, 1681-2. 7. *John*, bap. Feb. 12, 1688-9.

[For the information respecting the family and descendants of Dr. Thomas Boylston, Jr., of Muddy River, on page 91, we were indebted almost exclusively to the researches of Mr. Thomas B. Wyman, Jr. Since the printing of that page, he has made some corrections, and added greatly to the amount of that information, which he has published in the *Geneal. Reg.* vii. pp. 145-150. The *Genealogy*, is still far from being complete, and the compiler desires those who are interested in the subject, and are critical in such matters, to *communicate corrections and additions*, to *Mr. John Hunt, Boston*. To aid in this undertaking, and to give a more full and satisfactory view of that luxuriant branch of the old Watertown stock, we here insert in a condensed form, so much of that article in the Register, as seems to be clearly ascertained.]

- 1 [4.] THOMAS BOYLSTON, b. in Wat., Jan. 26, 1644-5, surgeon, of Muddy River (Brookline), m., in Charlestown, Dec. 13, 1665, MARY GARDNER, b. at Muddy River, Ap. 9, 1648. She d. July 8, 1722, aged 74. He was engaged in the Narragansett war. His estate prized at £560 14s. 10d. Chil,
- 2 1. EDWARD, a tailor, of Boston; m. MARY, dr. of John and Mary (Fowle) Dasset, of Boston. He is said to have been lost at sea (vessel foundered), in going to London. His wid. Mary, m. Josiah Flint. Chil.,
- 4 1. *Hannah*, b. 1696; d. 1697. 2. *Edward*, bap. Nov. 27, 1698.
- 5 3. *Thomas*, bap. Jan. 26, 1701.
- 6 2. RICHARD, b. about 1670; a cordwainer, of Charlestown; m. MARY SMITH, b. Feb. 18, 1677-8, only child of James and Mary (Foster) Smith, and gr. dr. of John Smith, ship-builder, of Charlestown. She d. Ap. 16, 1764, aged 86. He d. Ap. 25, 1752, aged 82. Chil.,
- 7 1. *Mary*, b. Feb. 23, 1698-9; m., in Charlestown, Oct. 27, 1719, *John Earle*, of Boston. [See Lawrence, 10, p. 331.]
- 8 2. *Ann*, b. Jan. 12, 1700-1; m. June 18, 1719, *Stephen Hall*. She d. in Charlestown, July 3, 1734 [gravestone].
- 9 3. *Elizabeth*, bap. Oct. 3, 1702; m. Ap. 26, 1724, Capt. *Nathaniel Wyer*. She was a wid. 1753.
- 10 4. *Sarah*, b. June 11, 1706; m., Aug. 26, 1724, *Jonathan Call*. She d. Oct., 1796, æt. 91. 15 chil.
- 11 5. *Dudley*, b. July 22, 1708; d. in infancy.
6. *Anna*, bap. 1710; m. Jan. 19, 1734-5, *Benjamin Brown*, of Boston, boat-builder; of Shirley, in 1782.
7. *Lydia*, bap. May 24, 1713; d. Oct. 9, 1713 [gravestone].
- 12 8. *Abigail*, bap. June 25, 1715; d. May 16, 1788; m. Dr. *Francis Moore*.
- 13 9. *Lydia*, bap. Jan. 31, 1719; d. Mar., 1791.
- 14 10. *Richard*, b. July 7, 1722; a brazier, of Charlestown; m. (1st), Ap. 16, 1747, *Mary*, dr. of Wm. Abrahams. He m. (2d), Oct. 13, 1763, *Parnell Foster*, bap. Aug. 24, 1729, dr. of Richard, Jr., and Mary Foster. He d. June 30, 1807, aged 85. Chil.,
- 15 1. *Mary*, m. Ezra Beamen. She d. at W. Boylston, June 9, 1813, aged 62.
- 16 2. *Richard*, bap. Sept. 17, 1752; a brazier, of Charlestown; m. Eunice Stetson. [See Stetson Genealogy.]
- 17 3. *William*, bap. Mar. 19, 1755; a brazier, of Charlestown and Boston; d. Sept., 1826; m. (1st), Mary B. Miles; m. (2d), in Boston, Oct. 25, 1792, *Hannah Gotte*. One son, *Nicholas*.
- 18 4. *Martha*, bap. June 20, 1756; m., in Boston, June 3, 1794, Dea. *Ephraim Frost*.
- 19 5. *Ann*, bap. Ap. 23, 1758; m. Ap. 15, 1788, *Ebenezer Jones*, of Princeton.
- 20 6. *Thomas*, bap. Ap. 13, 1760; a brazier, of Charlestown; m. Oct. 27, 1808, wid. *Mercy (Hay) Farnsworth*, dr. of John and *Mercy Hay*.
- 21 7. *Parnell*, bap. Dec. 23, 1764; m. *Thomas Brooks*.
- 22 8. *Hannah*, bap. Ap. 20, 1766; d. July 7, 1807.
- 23 3. ABIGAIL, b. 1674; m. EBENEZER BROOKS, of Medford, a grandson of Joshua and Hannah (Mason) Brooks, and the gr. father of Gov. John Brooks. She d. May 26, 1756, aged 82. [See Brooks, 80, in Part II.]
- 24 4. PETER, a shop-keeper, of Brookline; m. ANN WHITE. He d. Sept. 10, 1743. The Will of his wid. Ann, dated Mar. 13, 1754, proved Nov. 1772. May 2,

- 1713, his brother and other heirs, conveyed to him their shares in the home-
stead of 96 acres. Chil.,
- 25 1. *Benjamin*, b. Ap. 29, 1705; m., Nov. 30, 1727, *Elizabeth Sumner*, b. Ap. 7,
1708, dr. of Edward and Elizabeth (Clap) Sumner [Geneal. Reg. viii.
p. 128]; of Brookline, 1729, of Mendon, 1733.
- 26 2. *Ann*, b. Nov. 1, 1706; m. Mar. 21, 1729, *Ebenezer Adams*, b. Dec. 30, 1704,
youngest son of Joseph and Hannah Adams, of Braintree. 6 chil., of
whom the 5th was Zabdriel Boylston, b. Nov. 5, 1739; grad. Harv. Coll.,
1759, minister of Lunenburg. [See I. Stearns, App. IX. p. 547. Also,
Thayer's Family Memorial, pp. 45 and 6; also, Geneal. Reg. vii. p. 351.]
- 27 3. *Susanna*, b. 1708-9; m., Nov. 23, 1734, Dea. *John Adams*, of Braintree;
they were the parents of John Adams, President U. S. [See Bright, 47;
also, Thayer's Family Memorial, pp. 41-44.]
- 28 4. *Mary*, b. Sept. 15, 1714; m., in Boston, Sept. 5, 1740, *Nathan Simpson*, a
blacksmith.
- 29 5. *Elizabeth*, b. June 29, 1717; m., in Boston, June 4, 1742, *James Cunningham*.
- 30 6. *Jerusha*, bap. Feb. 8, 1719; m., Sept. 23, 1743, *Joseph Veasie*.
- 31 7. *Sarah*, bap. Mar. 17, 1723; m., *John Potter*, brazier.
- 32 5. SARAH, b., 1680; m., SAMUEL BROOKS, of Medford. She d. Oct. 16, 1736, æt. 56.
[See Brooks, 89, in Part II.]
- 33 6. LUCY, m. Mar. 10, 1702-3, BENJAMIN PHILLIPS, of Charlestown.
- 34 7. ZABDIEL, b. about 1679; an eminent physician, of Brookline; m., in Boston,
Jan. 18, 1706, JERUSHA MINOT, b. Jan. 28, 1679, dr. of John and Elizabeth
(Brick) Minot, of Dorchester. She d. Ap. 15, 1764, æt. 85, and he d. Mar.,
1766, æt. 87. [See Geneal. Reg. I. p. 173; and Thatcher's Am. Med. Biog.]
- 35 1. *Zabdriel*, b. Feb. 10, 1706-7, grad. Harv. Coll, 1724; d. in Eng., unm.
- 36 2. *John*, b. Mar. 23, 1708-9; settled in Bath, England, and d. there Jan. 17,
1795, æt. 86, unm. He was very liberal in his gifts to benevolent objects.
- 37 3. *Elizabeth*, b. June 29, 1710; d. young.
- 38 4. *Jerusha*, b. Nov. 5, 1711; m. Oct. 28, 1731, *Benjamin Fitch*.
- 39 5. *Mary*, d. May, 1802, aged 89, unm. Will dated June 3, 1796.
- 40 6. *Thomas*, b. July 30, 1715; a physician, of Boston; m., Nov. 15, 1745, *Mary
Coates*, s. p. His Will, dated July 26, 1749, proved May 29, 1750; wife
survived him.
- 41 7. *Elizabeth*, b. Jan. 4, 1716-17; m., Oct. 22, 1747, Dr. *Gillum Taylor*, of Bos-
ton.
- 42 8. *Josiah*, b. July 11, 1720; d. early.
- 41 8. MARY, (?) m. (1st), LANE; m. (2d), HUBBARD; m. (3d), DWIGHT.
- 42 9. REBECCA, b. Sept. 15, 1685; m., May 25, 1708, WILLIAM ABBOT. She d. in
Rox., Sept. 7, 1762, aged 76 [gravestone].
- 43 10. DUDLEY, b. about 1688, of Brookline; m., ELIZABETH GARDNER. He d. Ap.
18, 1748, æt. 60. Estate, £2410 13s. (? O. T.). Her Will, dated Mar. 2, 1772,
proved Oct. 31, 1776. Chil.,
- 44 1. *Ann*, m., *Robert Williams*, of Boston.
- 45 2. *Mary*, b. Dec. 25, 1719; d. Jan. 3, 1727.
- 46 3. *Elizabeth*, m. in Rox., Mar. 9, 1756, *Benjamin Williams*. 4 chil. She d.
before 1772.
- 47 4. *Dudley*, b. about 1723; d. Aug. 29, 1749.
- 48 5. *Joshua*, of Brookline; m., Mar. 22, (?) 1783, *Abigail Baker*, who d. Oct.,
1814, æt. 70. He d. about Nov. 1, 1804, æt. 79.
- 49 1. *Abigail*, b. Jan. 28, 1784; m., May 31, 1810, Dea. *Joshua Clark*. She
d. Dec. 14, 1825, æt. 42.
- 50 2. *Rebecca*, d. Oct. 3, 1817.
- 51 6. *Mary*, d. Oct., 1815, æt. 88, unm.
- 52 7. *Richard*, a cordwainer, of Brookline; estate (£27), admin. May 8, 1750.
- 53 8. *Caleb*, b. Mar. 19, 1730; living at the South, 1796.
- 54 9. *Sarah*, bap. Aug. 6, 1732; m., Dec. 22, 1761, *Samuel Davis*.
- 55 10. *Susannah*, b. Dec. 5, 1734; m., in Rox., Aug. 18, 1757, Dea. *Samuel
Sumner*. 4 chil. [Geneal. Reg. viii. p. 128 n.]
- 56 11. *Edward*, b. Jan. 2, 1737-8; of Springfield; wife *Lydia*. He d. Dec. 21,
1814, æt. 77.
12. *Hannah*, m., *Beza Cushing*.
11. JOANNA, m., July 5, 1714, JAMES LANDMAN.

- 57 12. THOMAS, a saddler and shopkeeper of Boston, m., May 14, 1715, SARAH, dr. of Nicholas Morecock. His Will, dated Mar. 28, proved Ap. 6, 1739. His wid. d. Feb. 1774. Chil.,
- 58 1. *Nicholas*, b. Mar. 13, 1716; lived in School Street, Boston, owner of a pew in Brattle St. Church. His Will, dated Aug. 1, proved Aug. 30, 1771. He endowed a professorship in Harvard College. He directed his executors to purchase the ancient homestead in Brookline, which had belonged to his grandfather, Dr. Thomas Boylston, and to convey the same to Brookline Church.
- 59 2. *Sarah*, b. Jan. 7, 1717 (?), m. in Boston, Sept. 23, 1743, *Edward Robinson*.
- 60 3. *Anna*, b. Jan. 8, 1719.
- 61 4. *Thomas*, b. Oct. 7, 1721, a merchant, of the Parish of St. Martin's Vintry, London, where he d. Dec. 30, 1798, unm. He made bequests to the city of Boston.
- 62 5. *Mary*, b. Feb. 19, 1722, m. June 13, 1746, *Benjamin Hallowell*. 14 chil., one of whom assumed the name Ward Nicholas Boylston. Another was Sir Benjamin Hallowell, an Admiral in the British Navy. Another, *Mary*, m. Judge Elmesley, of Montreal.
- 63 1. Ward Nicholas Boylston, a merchant, of London, of Rox., and Princeton, Mass., m. (1st) *Mary*. He m. (2d) *Alicia Darrow*, of England. His Will, dated Feb. 5, 1828. As a trustee, and in his own right, he held much wealth, and was a very liberal benefactor. Chil.,
- 64 1. *Nicholas*, d. in London, East India Co. Service.
- 65 2. *Thomas*.
- 66 3. *John Lane*, of Princeton, m. *Sarah Brooks*, b. about 1791, now (1853) a widow. Chil.,
- 67 1. *Ward Nicholas*, grad. Harv. Coll. 1835, M.D. 1839, M.M.S.S. of Princeton.
- 68 2. *Thomas*, of Rox., m. *Caroline A. Fowle*.
- 69 3. *Alicia*, b. 1822. 4. *Mary Hallowell*, b. 1825.
- 71 5. *Louisa Catharine Adams*, b. 1828.
- 72 6. *Nathaniel*, b. Mar. 21, 1724; of St. Christopher's, in 1771.
- 73 7. *Lucy*; b. Sept. 28, 1725, m., in Boston, *Timothy Rogers*.
- 74 8. *Rebecca*, b. Dec. 7, 1727, m. Aug. 13, 1773, Lieut. Gov. *Moses Gill*, of Massachusetts.

p. 92. **BRANCH**.—MARY BRANCH moved from Boston to Watertown, May, 1756. Wid. ABIGAIL BRANCH moved from Wat. to Charlestown, Ap. 1758.

BRAYBROOK.—Oct. 5, 1647, JOHN BRABROOK, of Wat. by power of attorney from John Glover, sold to Nicholas Birom, of Weymouth, land in Watertown. Jan. 5, 1651-2, the town granted John Brabrook £30 towards his loss by fire. Nov. 1654, the court appointed the selectmen of Wat. administrators of John Brabrook, who d. leaving children. Dec. 23, 1657, the court ordered John Flemming to provide Thomas Brabrook, apprentice, double apparel, at the judgment of Hugh Mason and Dea. Thomas Hastings. Ap. 2, 1663, the selectmen ordered to take wid. Brabrook from Woburn, who is there in distress.

BREWER.—[13.] DANIEL BREWER, m., Sept. 9, 1732, PHEBE, dr. of James and Sarah (Cutter) Locke. [See Locke Family, p. 35.]

p. 93. **BRIANT**.—Wid. BRIANT moved from Weymouth to Watertown, Nov. 1738.

BRIDGE.—[3.] (?)JOHN, b. June 15, 1645. [7.] For Samuel Harrington [40.] read Daniel Harrington [26].

[8.] Matthew Bridge m. Abigail Russell, of Cambridge. For 1722, read (?) 1727.

p. 94. [10.] Read, Abraham Watson.

[20.] Anna, m. Ap. 7, 1743.

[22.] Sarah, m., Ap. 4, 1753, Jonas Pierce [84].

[30.] Will of John Bridge, dated June 16, 1769, proved June 3, 1776.

[31.] Anna, m. — Sampson. [32.] Mary, m. — Parker.

[36.] Ebenezer, m. in Fram., Nov. 3, 1763, Mehitabel Wood.

[37.] Samuel Bridge m. (1st) Susanna Reed.

In margin, opposite to the last line, read 19. 41. For the parentage of Anna Perkins, see Mitchell's Bridgewater, p. 267. For Harrington 143, read [†143].

p. 95. [45.] For Mary (? Anna) read Nancy. For [143] read [†143].

[46.] Mary, b. Sept. 3, 1760. For 1843, read 1842.

[48-1.] Polly Bridge d. in Waltham, Sept. 24, 1854, aged 68.

[49.] For Brut, read Bent. [51.] Nathaniel Bridge d. Dec. 4, 1845.

4th line from bottom, for PIPPS, read Phipps.

BRIGHAM.—THOMAS BRIGHAM, proprietor of Wat. 1642. Homestall bounded E. by Camb. Line; S.E. by Charles River; W. by Samuel Saltonstall's homestall. He embarked in the Susan and Ellen, Ap. 1635, then aged 32. Thomas Brigham d. in Cambridge, Dec. 8, 1653. Land of John Brigan (Brigham) is mentioned as a boundary in 1644.

BRIGHT.

p. 96. 6th line from the bottom, for the best Saxon scholar, read, one of the best Saxon scholars.

p. 97. 5th line from the top, after proved, insert, in the Prerogative Court of Canterbury. For Batters, read Butters. 11th line from the top, after where he, insert, the testator. 14th line, after Will, insert legacies. 10th line from bottom, strike out, in what manner was not ascertained. 4th and 9th line from the bottom, for Barnett, read Bassett.

Since the Bright pedigree, on pages 98 and 99, was printed (in Sept. 1852), Mr. Somerby has been prosecuting his antiquarian and genealogical researches in England, and he has obtained much additional information respecting the early history of that family. Besides a few corrections, the additions are so great, that it is deemed advisable to reprint the pedigree, corrected and enlarged; and to append to it, in the form of notes, most of the information recently obtained. For the materials of this information, we are chiefly indebted to the personal researches of Mr. Somerby, and for the condensation and arrangement of them in the following pages, we are much indebted to Mr. Jonathan B. Bright, of Waltham, whose enlightened liberality has furnished the means for prosecuting these elaborate investigations.

That the Bright family of Suffolk, was one of high respectability among the gentry of that county, is evident from their many alliances by marriage, with persons of honourable houses. Although their lineage has been traced back no farther than to Walter Bright, of Bury St. Edmunds, yet there are reasons for believing the family to have been related to the Brights who flourished in the county of Kent, at a much earlier period. Catherine Bright, of Royton, in that county, who married Robert Waters, a gentleman of large estates, was the mother of Mary Waters, who afterwards became the celebrated Mrs. Honeywood, wife of Robert Honeywood, of Mark's Hall, in Essex. In 1709, her portrait was bequeathed by Thomas Bright, of Bury St. Edmunds, to his cousin Fisher; who, he says, was related to the Honeywoods. Some families of the name of Bright flourished in Essex and Norfolk, from a very early period, and as these counties adjoin Suffolk, it is quite probable that they were of the same original stock. The Suffolk family of Bright, in the male line, is believed to be extinct in England.

Henry Bright, the Anglo-American ancestor of the family embraced in this volume, was evidently the only one of the Suffolk family, that came to New England. It has already been shown (page 96), that he must have come over as early as 1630, as in that year he became a member of the first church of Boston, which was organized in Charlestown. As his name does not afterwards occur in the Boston Records, nor among those who remained in Charlestown, after the great removal thence to Boston, it is presumed that he went very early to Watertown, perhaps in 1630, although not with the very first settlers. His descendants, in the male line, have continued to reside in Watertown, and its vicinity, to the present time. They have never been numerous; but the pages of this volume show that those in the female branches, who trace their lineage to him, are very numerous.

Others of the name of Bright, came early to New England; but there are no reasons, derived from American records or traditions, for supposing that any of them were related to Deacon Henry Bright of Watertown; and the result of the extensive investigations in England, seems to prove clearly that they were not. Two of these were of Watertown, viz.: Henry Bright, "Sen." [see page 96], and Thomas Bright, who purchased the house

and homestall lot of Lieut. Robert Feake, and sold it, Dec. 17, 1640, for £60, to Col. William Rainborow. It is probable, that this Thomas Bright went to Hampton, about the time he sold his house and land in Watertown. Nothing is known of the origin or the date of the arrival of either of them. [May not this Thomas, be the Thomas Brighton, who embarked in the Truelove, for New England, in Sept., 1635, then aged 31?] Rev. Francis Bright, son of Edward Bright, of London, came over in 1629, in company with Mr. Higginson, settled in Charlestown, and returned to England the next year. [See Frothingham's Hist. of Charlestown, p. 25.] Samuel Bright, servant of John Sweet, was adm. f. c., first church in Boston, Sept., 1644, and was adm. freeman, May, 1645. The name Bright appears in Salem, in 1636, and in Hampton, in 1640, but it is not known what became of those bearing it. The name occurs frequently in Boston in the last century, as early as 1724, in church records; also in Dedham. Most of those in the United States, out of New England, are supposed to be descended from early settlers of this name in Pennsylvania.

NOTES TO THE PEDIGREE ON PAGES 708-9.

NOTE 1. (I. Generation.)—John Bright, of the Parish of St. Mary, Bury St. Edmunds, in the County of Suffolk, maltster, was living in the time of Henry VIII., when he held lands of the Abbot of that place, and may have been the father of Walter, Roger, and Margaret Bright. This is the only one of the pedigree not provable by Wills and parish registers. The register of the Parish of St. Mary, although it begins as soon as any in England, 1538, is not sufficiently old to contain the baptisms of those first named in the pedigree. No Will of this John Bright has been discovered. John Bryghte was witness to the Will of Anne Buckenham, of Bury St. Edmunds, May 20, 1539. He was buried June 26, 1545. This is the earliest Bright yet ascertained as residing in Bury St. Edmunds, from which circumstance it may be inferred, he was originally of another town or county. The name is common in the adjoining counties of Essex and Norfolk. It is, therefore, possible that the Brights of these three counties, were originally from the same stock. At this time, there is but one person of the name living in the County of Suffolk, and he, a descendant of a family of Shropshire, whose ancestor settled in this county, in the last century.

NOTE 2. (II. Gen.)—Walter Bright, of the Parish of St. Mary, Bury St. Edmunds, mercer, was a man of wealth and consideration in that place. He owned a house in College Street. He was one of fifty-two parishioners of St. Mary's, who, in 1546, authorized the churchwardens, of whom John Bright was one, to sell the church plate, for the repairs of the church. His Will, dated October 28, 1550, proved in the Prerogative Court, in London, Feb. 6, 1551, provides for his wife Margaret, she to have his dwelling-house in College Street for one year, and all the property she brought with her. His son, John, "to have a harness for a man, with half a sheaf of arrows." Son Edmund, a house. Son Thomas, to have a close, with appurtenances, in Westgate Street. Legacies to his daughter Joan, wife of Thomas Cage, and their children, Mary and John; to his brother Roger Bright, and his sons, Augustine, Nicholas, and Thomas; to his sister Margaret Page, and her sons, George and John. Legacies in money, to all his children and grandchildren, to the poor, and to St. Mary's Church. The name of his first wife, and mother of all his children, has not been ascertained. His second wife, was Margaret Elwolde. It is possible she married, after his decease, Wm. Jervis, of Whepstead, Gent., as Thomas Bright in his Will, dated August 20, 1587, appoints his father-in-law, said Wm. Jervis, supervisor.

Of the descendants of the other sons of Walter, viz., John and Edmund, and his daughters, Joan and Katherine, nothing is known beyond what is mentioned in the pedigree.

NOTE 3. (II. Gen.)—Roger Bright, of Bury St. Edmunds. He and his sons, are mentioned in his brother, Walter Bright's, Will, October 28, 1550. The Will of his widow Joan, dated Bury St. Edmunds, Feb. 4, 1578, and proved March 26, 1580, mentions her son Thomas Bright, and his children, Thomas, Agnes, and Margaret, not 18 years of age



PEDIGREE OF BRIGHT.

Compiled from Original Manuscripts in the Herald's Visitations, Deeds, Wills, Parochial Registers, &c., &c., and from Monumental Inscriptions.

BY HOBATIO G. SOMERBY, ESQ.

JOHN BRIGHT = * * * *

of Bury St. Edmunds, County of Suffolk, England; buried June 28, 1648 (Note 1).

Margaret Elwolds=Walter Bright
2d wife, m. Jan. 28, 1646.
of Bury St. Edmunds,
died 1580-1.
(Note 2.)

= * * * 1st wife.
of Bury St. Edmunds,
died Feb. 4, 1578.
(Note 3.)

Roger Bright=Joan Rolfe.
of Bury St. Will dated Feb.
4, 1578.
(Note 3.)

Margaret Bright=* * * Page.
George.

Mary, bap. July 18, 1643; p. l.
1643; m. Thomas Rd Collign,
Baillou, Nov. 17,
1689.
Sept. 30, 1699.
1678.
William.
Margaret
Cranvill,
Elizabeth.

Annie
bap. Nov.
19, 1639; m.
Thomas
Whight
Baillou,
Aug. 28,
1697.

Mary, bap. Oct. 16, 1667.
2d husband,
Thomas
Rd. Island,
m. 1688.

Augustine, Thomas Bright=Alice Stone,
Nicholas. m. Oct. 16, 1667.
2d husband,
Thomas
Rd. Island,
m. 1688.

Thomas, b. Agnes,
July 4, 1680. Margaret.

John Bright=Alice Waiot, Joan=Thomas Coge. Katherine=* * * Batt. Anne * * * Edmund Bright=Catherine Copsey. Thomas Bright,
of Bury St. Edmunds, m. June 16, 1644. Will dated July 10, 1648. m. 11, 1600. (Note 5.)

1st wife
buried
Dec. 12,
1668.

Margaret, Thos. Bright=Mary Cook,
bap. Ap. 10, 1658; bur. Mar. 3, 1692.
June 14, 1661.
1655.

Margaret Payton,
Mary,
Dorothy,
Frances.

Walter, Thomas, Mary, mar. Ocely, mar. Margaret, Alice, bap.
buried 1650. m. June 16, 1644. Will dated July 10, 1648. m. 11, 1600. (Note 5.)

Thomas, m. June 16, 1644. Will dated July 10, 1648. m. 11, 1600. (Note 5.)

Margaret, Thos. Bright=Mary Cook,
bap. Ap. 10, 1658; bur. Mar. 3, 1692.
June 14, 1661.
1655.

Robert, Alice,
bap. Nov. 8, 1664. 16, 1668.
Catherine, Susan,
bap. Dec. 9, 1673.
16, 1665.
Edmund, bur. May 16, 1678.
bap. May 24, 1667; bur. Nov. 28, 1668. 24, 1674.

Thomas, m. June 16, 1644. Will dated July 10, 1648. m. 11, 1600. (Note 5.)

Margaret, Thos. Bright=Mary Cook,
bap. Ap. 10, 1658; bur. Mar. 3, 1692.
June 14, 1661.
1655.

Robert, Alice,
bap. Nov. 8, 1664. 16, 1668.
Catherine, Susan,
bap. Dec. 9, 1673.
16, 1665.
Edmund, bur. May 16, 1678.
bap. May 24, 1667; bur. Nov. 28, 1668. 24, 1674.

Margaret Payton,
Mary,
Dorothy,
Frances.

Margaret Kent—Thomas Bright—Susan, bap. Alice, bap.
 1st wife, m. July of Bury St. E.; 2d wife, buried
 11, 1671; bur. d. 1688. (Note May 6, 1614.)
 Feb. 7, 1689.
 Constance, bap. Margaret, bap. Mar. 26,
 July 17, 1679, bur. Mar. 26, 1686.
 bap. Oct. 26, Thomazine, bap. Oct. 26,
 1682; bur. bap. Sept. 3,
 Sept. 9, 1614.

Robert Bright—Katherine, bur. Aug. 6, 1668.
 of Netherhall, C. 1880.
 (Note 8.)
 Henry Bright—Marie *** Jasper ***
 of Bury St. E.; 2d husband bap. Dec.
 sep. Sept. 23; Wm. Cole. 6, 1667.
 (Note 10.)
 1613.
 Thomas, living, Oct.
 1, 1680.
 Mary—Wm. North, Thomas, Elisabeth, John, Henry Bright—Anne Goldstone, Stephen, bap. Martha m.
 (Note 12.) bap. Nov. 28, 1696, 17, 1698; will proved 13, 1600. 1692; mar. May 12, 1608.
 William, Mary, Abigail, (Note 13.) *** Del. (Note 14.)

John Bright—Mary Style, Thomas, Anne, Margaret, Mary, Edmund—Susan Alrton,
 bap. Aug. 12, 1693; died d. Aug. 31, bap. Oct. 2, 1696; 1697; m. bap. June 2, 1696; bap. April 6, 1690; bap. Oct. 26,
 March 17, 1690, Lord of 1679, 19, 1696; 1697; m. living 1668. bap. Nov. 28, 1696, 17, 1698; will proved 1699.
 the Manor of Talmach 2d husband, bur. Oct. — Gibbon. Will Mildenhall. Will
 Hall, in Brist, County Hon. John 29, 1601. dated Jan'y, 1668. of Holy Well Row, 1699.
 Suffolk. (Note 24.) North. John. bap. May 6, 1602. (Note 25.) Son d. young.

Sarah Gleason—William Bright—Sarah North, 1st John, Thomas Bright—Dorothy *** Elisabeth—Thomas Salter,
 2d with mar. of Talmach Hall, wife, dr. of Hen- bap. Nov. d. Feb. 20, 1710, son of Martin
 August 31, 7, 1694. d. Jan'y, 24, 1631, aged 72. (Note op's Hall, Bak-
 1704. 26.) d. May, 1657, 28.) (Note 27.) tisbury, county
 Suffolk. (Note 24.) North. Kt. (Note 27.) Suffolk.
 Sarah—Thomas Dawtry, Esq., Sheriff of Essex, Mary, John, Thomas!
 bap. Feb. 1, 1664. d. More in Sussex, and Doding- bap. Nov. 21, 1662, Saml. Bately, M. P. for Bury
 1, 1664. burst Place. Westthrope. St. E. 1710.

Sarah Dawtry—Edward Lather, Esq., Sir William Dawtry, Kt., Rebecca Lather, Esq.,
 of Milsen, in Essex. of Moor House and Dod- m. Henry Fane,
 Sheriff 1701. daughter Place. Charlotte Lather, m. John Taylor, Esq.
 Richard Lather—Charlotte Chamberlin, dr. of Hugh Chamberlin, M. D., Court Physician. (Note 29.)
 of Milsen, co. Essex. M. D., Court Physician.

John Lather—Lavinia Bennet, Charlotte Lather, m. Henry Fane, Rebecca Lather, m. John Taylor, Esq.
 M. P. for Essex. (Note 29.)

Thomas Bright—Agatha William, Henry Bright—Martha Fluke,
 of Netherhall. Milson. of Netherhall, dr. of Wm.; bap.
 (Note 16.) bap. Oct. 14, May 3, 1697; m.
 1683. (Note 17.)
 William, of Hull?

Thomas Bright—Elisabeth Robert, Boroalde, Two drs.
 of Netherhall, Higham, Will dated living 1652.
 d. at Thorpe, dr. of Ole. April 21, Elisabeth,
 Morieux; bur. ment 1652, living 1668.
 June 8, 1713. Higham. (Note 19.) Dorothy, living 1666.
 (Note 18.) Agatha, will dated 1666.

Thomas Bright—Mary Grigson, Agatha, Mary,
 of Netherhall, dr. of William, b. 1663, d. Will dated
 bap. Jan. 6, 1690, dr. of Forncott, Dec. 10, May 24, 1729;
 d. April 2, 1727, St. Peters, 1732; unm. m. John Buby,
 co. Norfolk. (Note 20.) of Thorpe, Mordoux.

Thomas Bright, of Mary, bap. Nov. 16, 1716; mar. Robert
 Sept. 20, 1718; d. Edmund Terrell, of Ipswich,
 Dec. 31, 1738, unm. June 28, 1744. (Note 22.) Thomas
 (Note 22.) of Thorpe, Mordoux, will dated May 28, 1668.
 (Note 30.) Two sons.

Robert, of Katherine, John, Martha, William, Thomas,
 Ipswich; will m. Francis, m. Robert, of Ipswich,
 dated May Woodward, Nicholas, will dated
 28, 1668. (Note 30.) June 11, 1668.

Daughter Agnes (Annie?), and her husband, Thomas Whight, and their children, viz:—Margaret, Mary, Dorothy, Elizabeth, and Frances, not 18.—Daughter Margaret, and her husband, Richard Collyn, and their children, Margaret, Cranvys, and Elizabeth.—Daughter Mary, and her husband, Thomas Balles, and their son William.—Brother, John Skott, and his wife Alice, and their daughter Mary. Sister, Jackesonne. Her god-daughters, Katherine, and Alice, children of John Bright, and several others. John Skott, and Thomas Bright, draper, executors.

NOTE 4. (II. Gen.)—Margaret Bright, wife of — Page, and her two children, George and John, are mentioned in her brother Walter's Will, October 28, 1550. Nothing further is known of them.

NOTE 5. (III. Gen.)—John Bright, of the Parish of St. Mary, Bury St. Edmunds, clothier. He lived in College Street. He is mentioned in his father, Walter Bright's, Will, Oct. 28, 1550; also in the Will of Joan Bright, widow of his uncle, Roger Bright, Feb. 4, 1578. His own Will, dated August 5, 1593, proved in the Prerogative Office, in London (a copy of which is at Bury St. Edmunds), gives to his wife Alice, during her life, all his lands, tenements, meadows, &c., &c.; legacies to his daughter Joan, wife of Thomas Osburne, and their children Thomas, John, Jane, Susan, Alice, and Joan; to his daughter Mary, wife of Henry Cage, and their children, Henry, Mary, and Margaret; to his daughter Cicely, wife of Robert Beane; to his daughter Margaret, a house and grounds, in Church Govel Street; his wife, Alice, to have the charge of said Margaret and her property during life, from which it is inferred that Margaret was of unsound mind; gives to his daughter Alice, wife of Nicholas Sharpe: to his daughter Catherine, wife of Henry Copey, and to the children of his brother, Edmund Bright. Appoints Thomas Bright, son of his brother Thomas, supervisor. His widow, Alice Bright, made her Will at Felsham, Co. of Suffolk, in 1600, which was proved, at Bury St. Edmunds, in September, the same year; gives to her daughters, Joan Osburne, Mary Cage, Catherine Copey, Alice Sharpe, Margaret Bright, and Cicely Beane, and her grand-daughter Cicely Beane, and son-in-law Robert Beane; speaks of her house, in College Street; appoints her daughter Joan, governess of her daughter Margaret, and executrix to her Will, and her kinsman, Thomas Bright, son of Thomas Bright, deceased, supervisor.

NOTE 6. (III. Gen.)—Edmund Bright, son of Walter, of the Parish of St. Mary, Bury St. Edmunds, and wives, viz.: 1st, Anne —, 2d, Catherine Copey. Administration by his widow, March 27, 1589. He is mentioned in his father Walter's, and his brother John Bright's Wills. Nothing is known of this branch beyond his children, and the children of his son Thomas Bright.

NOTE 7. (III. Gen.)—Thomas Bright, the elder, was of the Parish of St. James, in Bury St. Edmunds, draper. He was the alderman (chief magistrate) of Bury, lord of the manor of Brookhall, in Foxearth, Co. of Essex, and of the manor of Butters Hall, in Thompson, Co. of Norfolk. His Will, dated August 20, 1587, was proved in the Prerogative Court of Canterbury, September 23, 1587. He gave to his wife Margaret, during her life, the manor of Butters, with 400 sheep, and tenements called Bees and Brightmeas; also the manor of Brookhall: also lands and tenements in Bury St. Edmunds, Great Barton, Nowton, and Fornham, St. Martins. After her death, his son Thomas to have the Norfolk estate, and Walter, son of said Thomas, to succeed. To son Robert, his property called Barton Place, in Great Barton. To son Henry, his lands, tenements, and fields in Barton, and in other towns and parishes, which he had purchased of Sir Robert Jermyn, Knight, and George Cocke; also a stone house in Whiting Street; also a tavern and other buildings on Angel Hill, Skinner's Row, Smith's Row, and Frier's Lane, &c., and other places in Bury St. Edmunds. Son Thomas to have, with other property, the close in Westgate Street, which his father Walter gave him by his Will. To son Jasper, certain tenements in Nowton, and a house in Bury St. Edmunds, &c., &c. Legacies to daughter Margaret, wife of Robert Roodes; to daughter Agnes, wife of Thomas Reade, and to daughters Katherine and Susan, not 21 years of age. Mentions his godson Thomas, son of his brother Edmund, and brother John. Gave to the Feoffees of the Guildhall Feoffment, Bury St. Edmunds, for several charitable purposes, the sum of £300. Appoints sons Thomas and Robert executors, and his father-in-law, William Jervis, of Whepstead, Gent., supervisor of his Will. His estates were large. In the Rolls Chapel, London, are three Inquisitions. Post Mortem, describing his lands in Essex, Norfolk, and Suffolk. His portrait, procured by the Corporation of Bury St. Edmunds, hangs in the Guildhall. By

permission of the town authorities, a copy has been made, which is in the possession of J. B. Bright, of Waltham, Massachusetts. His wife Margaret (Payton) Bright, held her first Court for Butters Hall Manor, August 14, 1590. Her Will is dated Nov. 20, 1599, and was proved in the Prerogative Court, at London, March, 1600. She was then residing in London, probably with her son Robert, who was afterwards of Netherhall. She gave to her sons, Robert, Henry, and Jasper, and her daughters Anne Reade, Katherine Barker, Joan Houghton, and Susan Barber, £100 each; to the children of her sons Thomas, Robert, and Henry; to the poor of the Parishes of St. James and St. Mary, in Bury St. Edmunds; to the poor of Thompson, in Norfolk; Barton and Risbie, in Suffolk. Mentions her brothers, Ralf Payton, Adam Payton, and George Payton; sisters Reyner, and Rose Langhan; late sister Sybil Hancock, deceased, and sister Margery Wilson. Appoints her sons-in-law, Bennet Barker and Edmund Houghton, executors, and her son Robert Bright, overseer. He wrote his name, *Bryght*.

There are some records of proceedings in relation to Thomas Bright's legacy of £300, to the Guildhall Feoffment, down to 1612, but there is no distinct or separate account of it subsequent to that date.

The Suffolk Directory, for 1844, contains an account of the Guildhall Feoffment; a list of its houses, farms, tenants, &c., vested in the Guildhall Feoffees of Bury St. Edmunds, in trust, for the public use and benefit of the inhabitants of the town, and for specific charitable purposes; the rents in 1838 amounting to £2000. Then follows a list of donations, in which are mentioned those of Thomas Bright, Sen. (viz. £300, besides the tithes of Foxearth); by Thomas Bright, Jr. (viz. in the time of Charles I., two messuages in the Fish or Meat Market, afterwards burnt down); and by Lady Carew [dr. of Thomas Bright, Sen.] (viz. £100 laid out for a tenement and land, called Jeckes, at Hepworth). From this we may infer, that these legacies have not been squandered nor diverted from their original purposes, but they probably became merged in, or incorporated with, other possessions held by the Feoffees.

It is to be observed that in the time of Thomas Bright, Sen., money was of eight times its present value, which would make his bequest equal to £2,400 at the present time.

Wright's *His. of Essex*, Vol. I., p. 573, says, "Mr. Bright left an annuity of £12 to be paid out of the estate of Brookhall, for poor prisoners and widows, and for the use of St. Edmundsbury school."

NOTE 8. (IV. Gen.)—Thomas Bright, son of Thomas, the elder, of the Parish of St. James, Bury St. Edmunds, was alderman or chief magistrate of Bury, in 1610. His arms were entered in the Herald's College, by William Camden, Clarencieux, 14 James I. (1616). He received by Will, from his father, the Manor of Butters, in Thompson, Co. of Norfolk, and held his first court there, August 6, 1620.

He was supervisor of the Will of his aunt Alice, and one of the executors of his father's Will. He died in 1626, and was buried in the churchyard of St. Mary, Bury St. Edmunds. By Deed, in 1625, he gave to the poor of St. Mary's Church; to the prisoners in the county gaol; for the repairs of the churches of St. Mary and St. James; and for cakes and wine at the annual meeting of the Feoffees.

Nothing further than what is mentioned in the pedigree is known of his wives, Margaret Kent, and Margaret Beton. Mary, wife of Thomas Bright, gent., was buried in the Parish of St. Mary, September 4, 1625, probably a third wife of this Thomas.

His name appears in the first charter from James I., dated April 3, 1606, to Bury St. Edmunds, and also in the third charter of James I., to Bury St. Edmunds, dated September 17, 1614.

His grandson, Thomas Bright, in his Will, dated March 1, 1709, bequeaths to the town of Bury St. Edmunds, a portrait of King Edmund, which he desires may be hung in the same room with that of his grandfather. Neither of these pictures can now be found. That of Thomas Bright, the elder, is still in existence, and easily distinguished by the inscription at the bottom.

NOTE 9. (IV. Gen.)—Robert Bright, son of Thomas, the elder, moved to London, where he was living in 1600. He subsequently became lord of the manors of Netherhall, in Thurston, and "New House," in Pakenham, both in the County of Suffolk. He had arms confirmed to him, as second brother of Thomas Bright, of Bury St. Edmunds, with a crescent on the bend, for difference. In 1620, he built the manor house called "New House," in a very elaborate style of architecture. He made his Will, October 1, 1630, which was proved in the Bishop's Court of Norwich, March 1, 1631. He gives to his son Thomas, who succeeded to the Netherhall Estate, a tenement called *Battlelies*. To his

son William, a farm, called Barton Place, with the fisheries thereunto belonging. To his son Henry, "New House," in Pakenham, houses and lands in Cockfield, and lands in Norton. Legacies to his brother-in-law, Thomas Reade, of Bury St. Edmunds; to his three sisters, Lady Carew, Katherine, wife of Bennet Barker, and Joan, wife of Edmund Houghton; also to Thomas, son of his brother, Jasper Bright. His estates were extensive in the County of Suffolk, all of which, in consequence of the failure of male issue, in subsequent generations, have gone with the females to other families. As the wife of Robert Bright is not mentioned in his Will, it is to be presumed she died before him. Her family is not known. [See p. 100.]

Netherhall stands partly in Pakenham and partly in Thurston, near the parish church of the former, and about six miles from Bury St. Edmunds. The Ashfields, Knights, who were originally of Stowlangtoft, appear to have been seated here about the time of Henry VIII., and it passed to the Brights about a century afterwards. The Hall has undergone some changes in its exterior, and now, 1853, belongs to William Chinery Bassett, Esq., who is lord of the manor. "New House" was sold to Sir William Spring, for a dower house for his lady, soon after the death of Robert Bright. It is now the seat of its owner, the Rev. W. J. Spring Casborne, who is also impropriator of the Rectory. Mr. Casborne inherits the estate through the female line, from Sir William Spring, the male issue being extinct.

NOTE 10. (IV. Gen.)—Henry Bright, son of Thomas the elder, was of the Parish of St. James, Bury St. Edmunds; where he was baptized September 20, 1560. He died in 1609, intestate. A chasm in the administration records between the years 1609 and 1630, deprives us of some facts in relation to the family, which it would be desirable to know. He was a man of considerable wealth, and proprietor of several estates in Bury St. Edmunds, and the neighboring villages. An Indenture, dated March 20, 1606, is among the corporation records, by which Henry Bright, and his wife Mary, lease to the town, for certain purposes, the Angel Hotel, a messuage in Cook's Row, Abbeygate Street, and several tenements, shops, &c., in various parts of the town. He owned houses adjoining the Angel Hotel, which are still standing. His name appears in the first charter from James I., to Bury St. Edmunds, dated April 3, 1606. Of his wife's family, nothing has yet been ascertained. After his death she married William Cole, Gent., of Bury St. Edmunds. She is mentioned in the Will of her son Thomas Bright, of Ipswich, dated April 17, 1618.

NOTE 11. (IV. Gen.)—Susan Bright, daughter of Thomas Bright the elder, was first married to — Barber. She is mentioned in her father's, mother's, and brother Robert Bright's, Wills. Her second husband was Sir Nicholas Carew, Knight, of Beddington, in the Co. of Surrey, and she was his second wife. His first wife was Maria, daughter of Sir George More, Knight, of Losely. His sister, Elizabeth Carew, was the wife of Sir Walter Raleigh, Knight. Lady Susan Carew died at Beddington, in 1638, and was buried in the church there. She gave the feoffees of the Guildhall Feoffment, at Bury St. Edmunds, £100, for the purchasing of lands to the yearly value of £5, which was to be equally distributed to five poor widows. It was laid out in the purchase of a tenement called Jeckes, in Hepworth, in 1636.

Her son Thomas Carew, died in infancy. She also had a daughter Susan Carew, of whom nothing further is known.

NOTE 12. (V. Gen.)—Mary Bright, daughter of Henry, and granddaughter of Thomas Bright, the elder, married William Forth, of Nayland, Co. of Suffolk, Gent., son of William Forth, Esq., of Butley, in the same county, of an ancient and highly respectable family, one of whom married John Winthrop, of Groton, who emigrated to New England. Her husband was one of the overseers, and her son, Dr. William Forth, of London, executor of the Will of her sister, Elizabeth (Bright) Dell, widow, of Stratford-le-Bow, in Middlesex.

NOTE 13. (V. Gen.)—Thomas Bright, son of Henry, and grandson of Thomas Bright, the elder, was baptized at the Parish of St. James, Bury St. Edmunds. He was a merchant in Ipswich, and died unmarried. His Will, dated April 17, 1618, proved in the Prerogative Court, at London, January 26, 1626; gives to his brother William Forth, of Nayland, —; to his mother, then wife of William Cole; and £70 each to his brothers John and Henry, when they shall be twenty-one years of age; also, legacies to his sisters Elizabeth and Martha Bright, and to Maria, daughter of Thomas Woodgate, of Ipswich.

NOTE 14. (V. Gen.)—Elizabeth Bright, daughter of Henry, and granddaughter of Thomas Bright the elder, was baptized at St. James, Bury St. Edmunds, Sept. 17, 1598. She married — Dell, whom she survived. Her Will, dated August 6, 1657, at Stratford-le-Bow, in Middlesex, gives to her brother "Master Henry Bright, of New England," and his children, —; to her sister Martha Blowers, and children, —; to her nephew William Parks, —; to her cousin, — Cawby, Esq., —; to the Rev. Mr. Greenhall, of Stepney, —; to the poor of Stepney, —; and legacies of 20s. each, to several persons for purchasing for themselves rings; appoints her nephew, Dr. William Forth, executor, and her brothers Blowers, and William Forth, overseers. She is mentioned in her brother Thomas Bright's Will, dated April 17, 1618.

NOTE 15. (V. Gen.)—Henry Bright, fifth child, and third son of Henry, and grandson of Thomas Bright, the elder, was baptized in the Parish of St. James, Bury St. Edmunds, Dec. 29, 1602. He came to New England, in 1630, and settled at Watertown, Massachusetts, where he married Anne, eldest daughter of Henry Goldstone. (See Goldstone, in Part II.)

He is mentioned in the Will of his brother Thomas Bright (see Note 13), and in the Will of his sister Elizabeth (Bright) Dell (see Note 14), who bequeathed him £200, and £70 to his children. These legacies were paid, in 1659, by her nephew, Dr. William Forth, of London, her executor, through his agent, Dr. Hezekiah Usher, of Boston, in New England. See in Vol. III., p. 286, of the Suffolk, Mass., Registry of Deeds, the release and acquittance of the same, executed by Henry Bright. He wrote his name, Henrie Bright.

NOTE 16. (V. Gen.)—Thomas Bright, of Netherhall, son of Robert, and grandson of Thomas the elder, succeeded to the Netherhall estate, and had the arms confirmed to him by Sir John Borough, the 29th July, 1641. He is mentioned in his son Robert Bright's Will, dated April 21, 1652. His wife was Agatha, daughter of — Mileson, and sister of Borodale Mileson, of Norton, Co. of Suffolk, Esq.

NOTE 17. (V. Gen.)—Henry Bright, of Netherhall, Gent., was baptized at Bury St. Edmunds, in the Parish of St. James. His father, Robert Bright, of Netherhall, bequeathed him the "New House" in Pakenham, which he built in 1620; also houses and lands in Cockfield; lands in Tostock and Norton, and houses and lands in several other places. The present proprietors of Netherhall have in their possession a plan of the estate drawn by this Henry Bright in 1620. On a corner of the plan is a sketch, in outline, of Netherhall, and the following note:—

Manor de Neatherhall, in Thurston, in comitatu Suff. Oxate mensum per HENRIUM BRIGHT, Octavo die Octobris, Anno Reg. Jacobi dei gratia Angliæ Franciæ et Hiberniæ decimo Octavo et Scotiæ quinquagesimo secundo.

He is mentioned, as is also his wife, in her father William Fiske's Will, dated March 20, 1648. Their son, Robert Bright, of Ipswich, speaks of his mother in his Will, bearing date 29th May, 1668.

NOTE 18. (VI. Gen.)—Thomas Bright, Esq., of Netherhall, and great-grandson of Thomas Bright, the elder. His Will, dated at Thorpe Morieux, in Suffolk, May 4, 1713, was proved at Bury St. Edmunds, Nov. 18, 1713;—desired to be buried in Thurston Church;—makes his son, Thomas Bright, sole executor; mentions his son-in-law, John Risby, and cousin Elizabeth Gosnall: directed £100 to be laid out in the purchase of land for the benefit of the poor of Thurston and Pakenham, the rents thereof to be applied in buying 12 pairs of shoes and stockings for such poor men and women, or children, as should most want or deserve the same. In satisfaction of this charity, £5 a year is laid out in articles of clothing, by the owner of the Netherhall Estate. His wife, Elizabeth, was the daughter of Clement Heigham, of Barrow, in Suffolk, Esq., one of the intended Knights of the Royal Oak, and great-granddaughter of Sir Clement Heigham, Knight, who represented the Co. of Suffolk in Parliament, in 1593 and 1634.

NOTE 19. (VI. Gen.)—Robert Bright, of Netherhall, great-grandson of Thomas the elder. His Will, dated April 21, 1652, proved in the Prerogative Court, at London, June 20, 1656, gives to his brother, Thomas Bright, his diamond ring;—legacies to his five sisters;—speaks of his father, Thomas Bright, his brother, Borodale Bright, and his cousin, William Bright. Mentions his hawks and goshawks.

NOTE 20 (VII. Gen.)—Thomas Bright of Netherhall, Esq., was baptized at Barrow, in Suffolk, January 5, 1660, and was buried at Thurston, April 2, 1727. His wife, Mary, was a daughter of William Grigson, of Forncoett, St. Peter's, Co. of Norfolk, Gent., and sister and heir of Wm. Grigson, Esq. She was buried September 27, 1744. In Thurston Church are monumental slabs in the floor, near the chancel, with these inscriptions:—

Here lyeth the body of
THOMAS BRIGHT, of Netherhall, Esq.

The remainder of the inscription is covered by a pew. Arms: Bright impaling Grigson.

Here lies the body of
MARY BRIGHT.
Pakenham.
Life
44.

A pew covers the rest of the inscription. The same arms are in a lozenge-shaped shield.

NOTE 21. (VII. Gen.)—Agatha Bright, daughter of Thomas Bright of Netherhall, was born in 1663, and died unmarried in 1732. Her Will, dated April 30, 1731, gives all her money and personal estate to her nephew, Thomas Bright, and to his sister, Mary Bright; to Mrs. Bright, their mother, a ring; to sister Risby, a ring. Desires to be buried in Thurston Church. The following inscription is on the monumental slab, with the arms of Bright, in a lozenge shield:—

Here lyeth the body of AGATHA
BRIGHT, Spinster, one of y^e daughters
of Thomas Bright, of Netherhall,
Esq. She died Dec^rbre y^e 10, Anno Dom.
1732, aged 69 years.

NOTE 22. (VIII. Gen.)—This Thomas Bright was the last of the Netherhall family in the male line. He was born in 1713, and dying unmarried, his sister Mary, afterwards wife of Edmund Tyrrell, became his sole heir. He was buried in St. Peter's Church, Thurston, of which he was patron. On a monumental slab is the following inscription, surmounted by the family arms:—

Here lies the body of
THOMAS BRIGHT
of Netherhall, in Pakenham, Esq.,
who departed this life
the 21st day of December,
In the year of our Lord Christ
1736,
Aged 23 years.

NOTE 23. (VIII. Gen.)—Mary Bright of Netherhall, sister and heiress of Thomas Bright, and the last of that branch of the family, married Edmund Tyrrell, Esq., of Gipping, in Suffolk, widower. She was living in 1754. During her life, the Netherhall Estate was sold to George Chinery, Gent., of Bury St. Edmunds. It now belongs to William Chinery Bassett, who, with his mother, resides there. Edmund Tyrrell was baptized at Benhall, Co. of Suffolk, Sept. 9, 1703. He was the son of Thomas Tyrrell, Esq., of Gipping, and Anne, daughter of Sir John Duke, Bart., M.P. for Oxford. By the death of his uncle, Sir Edward Duke, without issue, he became heir to his estates. His will, dated August 15, 1746, was proved in the Bishop's Court at Norwich, January 8, 1749. He desires to be buried in the family aisle in Stowmarket Church. The patronage of the vicarage of St. Peter's Church, in Thurston, once in the gift of the Brights of Netherhall, is still in the Tyrrell family, Charles Tyrrell, Esq., of Polstead Hall, being the present patron. Gipping has for many ages been the seat of a branch of this very ancient family, whose ancestors may be very satisfactorily traced to the period of the Norman Conquest, and for more than six centuries, its chief, in a direct line, enjoyed the honor of Knighthood. They derive from Walter Tyrrell, a Norman Knight. It has not been ascertained whether this Mary (Bright) Tyrrell left children.

NOTE 24. (V. Gen.)—John Bright, Gent., son of Thomas, and grandson of Thomas Bright, the elder, was baptized in the parish of St. James, Bury St. Edmunds. He was Alderman (chief magistrate) of Bury, as was his father and grandfather before him, and a Captain in the Parliamentary army. He sold the estate in Thompson, and bought the manor of Talmach Hall, in Little Bricet, Co. of Suffolk. He died March 17, 1660, aged 67 years. His Will, dated January 14, 1659–60, proved in the Prerogative Court, in London, May 8, 1661, gives to his wife Mary his houses and lands in Bury St. Edmunds; mentions his sons Thomas and William, his sister Gibbon's children, and his grandchild, John Salter; speaks of lands and tenements in Brockford and Wetheringsett, which he purchased of Thomas Colby, Gent., and lands and tenements in Ireland. He was buried in Bricet Church, where a beautiful marble monument against the north wall, near the chancel, surmounted with the family arms, impaling those of Style and North, perpetuates his memory. [See p. 102.]

Memoriæ Sacrum.

JOHANNIS BRIGHT de Talmach Hall
Generosi, qui obiit decimo septimo die
Martij anno millesimo sexcentesimo
Septuagesimo: et MARIE uxoris ejus
Filiæ GULIELMI STYLE de Hemingston
Generosi quæ post obitum supradicti
Johannis nupsit honorabili viro
JOHANNI NORTH Armigero Filio
Dudleii North Baronis de Cartleigh
Illa antem obiit tricesimo primo
Augusti anno millesimo sexcentesimo
Septuagesimo nono.

Hoc pietatis ergo mærens posuit
Parentibus GULIELMUS BRIGHT
Armiger et filius Primogenitus.

1680.

This inscription gives his death in 1670, which is an error. It should be 1660. His wife, Mary Style, was the daughter of Wm. Style, of Hemingstone, in the Co. of Suffolk, Gent. Her second husband was the Hon. John North, son of Dudley, third Lord North. Talmach Hall, the manor-house in the Parish of Little Bricet, is so called from its ancient possessors. In 21st Edward I. [1292], Hugh Talmach, and Maria, his wife, held lands here of the Countess of Gloucester, and his descendants continued here until 7 Edward VI. [1553], when John Talmach was the owner. It afterwards belonged to the family of Kemp, and then to the Brights. It is now the property of William Adair, Esq. The Hall still exists as a farm-house, though much dilapidated. The principal portion of the building was taken down about 40 years since, and hardly a vestige of its former greatness remains. It was once surrounded by a moat, traces of which are still perceptible. The Brights of this place were interred in Bricet Church. Little Bricet (which, in 1844, was a small hamlet, with only 25 inhabitants, and the Yarm of Talmach Hall), was annexed to Offton in 1503. It is 30 miles from Bury St. Edmunds, and 12 from Ipswich. [See p. 101.]

NOTE 25. (V. Gen.)—Edmund Bright, Gent., of Holywell Row, Mildenhall, Co. of Suffolk, baptized at St. James, Bury St. Edmunds, was a grandson of Thomas Bright, the elder. His Will, dated January 9, 1658, proved in the Prerogative Office, London, March 7, 1659, gives to his godson, Mr. Thomas Bright, son of his brother, Mr. John Bright, all his houses and lands in Bury St. Edmunds, houses and lands in Holywell Row, and Beck Row, in Mildenhall; legacies to his brother, Mr. Thomas Bright; to his cousin, Thomas Bright; to his godson, the son of his cousin, Henry Bright, deceased; to his sister, Mrs. Mary Bright, and to his cousin John Gibbons, his sister's son. Gives a rent-charge of four pounds per annum to the poor, which continues to be paid to this day, at the parish of St. Mary, in Bury St. Edmunds. Desires to be buried in the churchyard of St. Mary's, in Bury St. Edmunds, near his parents, and his wife and son. Edmund, son of Edmund Bright, baptized at St. Mary's, July 19, 1633, was probably this son. His wife Susan was the daughter of Edward Alston, of Boxford, Co. of Suffolk, clothier, and granddaughter of William Alston, Lord of Sayham Hall, in Newton, in the same county. A rent-charge of 40s., given by Edmund Bright, is yet distributed among the poor parishioners of St. Andrew's Church, in Mildenhall, out of land at Coldham Hills.

NOTE 26. (VI. Gen.)—William Bright, Esq., succeeded to Talmach Hall, on the death of his father, John Bright, in 1660. His own estate, in 1656, was represented to be worth £400 per annum. He married Sarah, daughter of Henry North, of Laxfield, Co. Suffolk, son of Sir Henry North, of Mildenhall, in the same county, Knight, who was a younger son of Roger, second Lord North.

His second wife was Sarah Gilson, whom he married 31st August, 1704. He was buried in Bricet Church, on the floor of which is a stone slab with the arms of Bright impaling those of North, and this inscription:—

Here lieth the body of
WILLIAM BRIGHT, of Talmach
Hall, Esq., who departed this
Life January the 7th, 1706, in the
Eightyeth Year of his Age,
who Married Sarah North,
here Likewise Buryed, one of
the Daughters of the Honourable
Henry North, of Laxfield, Esqr.
Their only Daughter Sarah
was Maryed to Thomas Dawtrey,
of More, in the county
of Sussex, Esqr.

Talmach Hall passed to the Dawtreys, by the marriage of Sarah, only daughter and heir of William Bright, to Thomas Dawtrey, of More, in Sussex, Esq., whose daughter Sarah married Edward Luther, Esq., of Myles, in Essex, and had with other issue, Richard Luther, Esq., eventually inheritor of the Dawtrey estates.

NOTE 27. (VI. Gen.)—John Bright, of Talmach Hall, Gent., son of John, was baptized at Bury St. Edmunds. He died at Talmach Hall, and was buried in Bricet Church, where there is a stone slab, much defaced, bearing the following inscription:—

Here lyeth the body of
JOHN BRIGHT, Gent.,
Who died
May, 1657.

NOTE 28. (VI. Gen.)—Thomas Bright, of Bury St. Edmunds, son of John Bright, of Talmach Hall, and great grandson of Thomas Bright, the elder, is mentioned in his father, John Bright's, Will, January 14, 1659–60. He died Feb. 20, 1710, aged 72 years. His Will is dated March 1, 1709, and proved at Bury St. Edmunds, May 18, 1711, in which he desires to be laid in Bury Churchyard, where his wife Dorothy is buried; makes his son-in-law, John Westrope, sole heir; gives him "the house where I now inhabit, in North Gate Street," and other houses in same street,—a house in Cooke Row, and houses and lands in Brettenham. "Item, I give to the towne and corporacon of Bury St. Edmunds, King Edmund's picture, to be hung up in the chamber where my grandfather Mr. Thomas Bright's picture, now hangs. I give to Mr. Sam. Bury, a picture or a landscape, now hanging over my great parlour chimney. I give to my she cousin, Fisher, a picture, is now in my little parlour, of Mary Waters, the widow of Robert Honeywood, of Charing, in Kent, she being related unto the Honeywoods." Gives to his son-in-law Samuel Battely, and his wife, £10 to buy them mourning; to his executor Robert Hayward, a ring; to his cousin Joseph Legg, of London, £5; to the poor of both parishes in Bury, and to his maid-servant Elizabeth Walford. "Item, I nominate my nephews, Edward and Thomas Salter, Edmund Spencer, Edward Luther, William Dawtrey, and Robert Fisher, to be my bearers, to beare up the pall; and I give to each of my bearers a gold ring, with this motto: 'Remember to follow Thomas Bright;' and I would have Edward Bullard, Sen., old Samuel Marshall, Samuel Ormes and Joseph Ormes, for my under-bearers, to carry and conduct my body to the ground." He gave to the under-bearers, each a coat or black gown. Mentions his daughter Alice Westrope, and cousin Bartholomew Young; desires to be buried in linen.

There is a handsome monument in the churchyard at Bury St. Edmunds, on the top slab of which are the arms of Bright, impaling * * * * and the following:—

THOMAS BRIGHT, Gent.,
Dyed the 20 Feby., 1710,
aged 72 years.

On the west end of the monument,—

Here Lieth the Body of
 DOROTHY, y^e wife of THOMAS
 BRIGHT, Gent., who departed this
 Life, December the 3d, 1684,
 In Hope of a Blessed
 Resurrection to Life Eternal
 Through the Meritts of our Lord
 Jesus Christ.

Mary Waters, whose portrait he bequeathed to his cousin Fisher, was the daughter of Robert Waters, Esq., of Royton, in the Parish of Lenham, and Co. of Kent, and his wife Katherine Bright, of Royton. From this, it is inferred, that Mary Waters was related to the Brights of Suffolk. She was a remarkable woman. In Wright's *His. of Essex*, Vol. 1, p 371, is an account of the family of Robert Honeywood, and of Marks Hall, the place where they resided, with a view of the hall. There are several portraits of Mary Waters, one at the Hall, and one at Coleshill, in Berkshire, the seat of the Earl of Radnor, who is descended from her, as is likewise his lady, through her mother Lady Mildmay. There is also a marble statue of her in the church at Marks Hall, as kneeling, with an inscription. She lived to see 367 descendants, viz.: 16 children, 114 grandchildren, 228 in the 3d, and 9 in the 4th generation. Her grandson, Dr. Michael Honeywood, Dean of Lincoln, in King Charles II.'s time; and whose monument is in the Minster, used to relate, that he was present at a dinner given by her to a family party of 200 of her descendants. She was born 1527, married in 1543, and died May 11, 1620.

NOTE 29. Luther, Dawtrey, and Chamberlen. The family of Luther, allied to the celebrated reformer, is first mentioned as of the County of Essex, in the reign of Henry VIII., when Wm. Luter had a lease from the crown, of the Manor of Albinis, in Stapleford Abbots. Richard and Anthony Luther, Esqs., "so truly loving brothers," as is expressed in their epitaph, "that no account whatsoever was kept between them," died in 1627, and were owners of the Manor of Miles. Richard Luther, the father of John, inherited the large estates of his uncle, Sir Wm. Dawtrey, Knt., and was one of the great landed proprietors of Essex. John Luther spent £50,000 in the contest when elected M. P. for that county. Dying without issue, his sister, Charlotte Luther, married to Henry Fane, Esq., of Wormsley, Co. Oxford, younger brother of Thomas, 8th Earl of Westmoreland; and Rebecca Luther, married to John Taylor, Esq., grandmother of John Taylor Gordon, M.D., were his heirs. John Taylor Gordon, M.D. and John Fane, are the present representatives of these ancient families of Dawtrey and Luther. The latter owns the Manor of Miles. The Dawtreys are deducible in an uninterrupted descent from the conquest. John de Alta Ripa, obtaining from Joscelyne, of Louvaine, a grant of the Manor of Haultrey, assumed the surname of De Haultrey, or Dawtrey, and founded the distinguished Sussex family of that name, and were descended through Margaret Roper, wife of Sir Wm. Dawtrey, Knt., of Moor House, Esq., from Sir Thomas More, Lord Chancellor of England. Sir Wm. Dawtrey, Knt. of Moor House, and Doddinghurst Place, son of Thomas and Sarah (Bright) Dawtrey, was Sheriff of Essex, in 1736, and died in 1758. Charlotte Chamberlen, wife of Richard Luther, was daughter of Hugh Chamberlen, M.D., of Alderton Manor, and Hinton Hall, in Suffolk, the celebrated court physician in the time of James II., and Queen Anne; now represented by John Taylor Gordon, M.D.

NOTE 30. (VI. Gen.)—The children of Henry and Martha (Fiske) Bright, of Netherhall, viz.: Robert Bright, of Ipswich, Grocer. His Will, dated May 29, 1668, and proved July 3, 1668, gives to his brother-in-law, Francis Woodward, £50; to his brother, John Bright, £250; to his sister, Martha Bright, £50; to his brother, William Bright, £3 to buy him a gold ring; to his co-partner, William Sayer, £10; to his mother, Mrs. Martha Bright, £10; to the poor of the Parish of St. Lawrence, 40s.; to the poor of the Parish of Pakenham, 40s.; to Mrs. Elizabeth Sayer, his partner's mother, £3 to buy a gold ring; to his brother, Henry Bright, £100; to his brother, Thomas Bright, £100. Appoints his brothers, Henry and Thomas Bright, executors.

Thomas Bright, of Ipswich, Gent., one of the bailiffs and portmen of that town. His Will, dated June 17, 1698, and proved Feb. 11, 1698-9, mentions his sister Katherine Woodward, of London, widow; his brother, Henry Bright, of Framiaden, in Suffolk, Gent.; the two sons of his brother-in-law, Robert Nicholas, living at Devises, in Wiltshire,

Gent., who married his sister, Martha Bright; his cousin, Thomas Meadows, of Holborn, London; his cousin Chapman, Minister of Framisden, John Gibbon, of Ipswich, and his kinsman, John Copeman, of Ipswich; also his cousin, Captain William Bright, of Hull, to whom he gives all his messuages, tenements, houses, lands, &c., in Copdock, and other towns and parishes in Suffolk; legacies to several persons for gloves, hat-bands, &c.; directs, that there shall be engraven on the stone now lying over his wife, the day of his death, who was bailiff and portman of the town of Ipswich; appoints John Copeman, executor, and his sister Woodward, supervisor. From his not mentioning his brothers, John Bright and William Bright (noticed in his brother, Robert Bright's, Will, in 1668), it is presumed they were deceased. It is probable, that his cousin, Captain William Bright, of Hull, whom he makes his principal heir, was a son of his uncle William Bright, of Netherhall, respecting whom nothing yet has been ascertained, beyond his name. Thomas Bright also bequeathed by his Will £100 stg., to be put out on good security, or else to be laid out in the purchase of land, by the bailiffs and portmen of Ipswich, and their successors, for the only use and benefit of two poor children of the Parish of St. Mathews, in Ipswich, in the hospital of said town, forever. The "Suffolk Directory" (1844), mentions land purchased in 1722, with £340, left to the Hospital by Thomas Bright, and Richard Philips.

- p. 103. 8th line from the bottom, for Esling, read Elsing. 6th line from the bottom, for Frisborough, read Finborough.
- p. 105. [1.] May 13, 1640, the Gen. Court appointed Henry Bright one of the committee to apprise horses, cows, and other cattle, for the purpose of making a rate of £1200 for the colony. Aug. 27, 1640, he was appointed by the court, and sworn as surveyor of arms in Watertown, "for this year, and till a new be chosen." The records contain no new appointment for the next ten years.
- [Note.] See Goldstone, in Part II.
- p. 106. [4.] See note, p. 524. Dea. John Bright was selectman 1684 and 1690. His inventory, dated Dec. 9, 1691, embraced $\frac{1}{4}$ of the gristmill, sawmill, and the lands and utensils pertaining thereto, appraised at £40; total, £165 15s. These were the mills on Stony Brook.
- [7.] For 1590, read 1690. [9.] In 1713, Elisha Odlin was licensed to keep a public house in Salem.
- [10.] Hannah Odlin m. Benjamin Dyer. [12.] See Saltonstall [35.], in Part II., note.
- p. 107. [16.] Capt. Samuel Ruggles m. (1st) in Rox., Jan. 16, 1654-5, Hannah Fowle. His 2d m. is also recorded in Roxbury.
- [17.] Rev. Thomas Ruggles, Sen., ord. in the autumn of 1695.
- [19.] Rev. Thomas Ruggles, Jr., was ordained in Guildford, Mar. 26, 1729. He was author of the History of Guildford. Mass. Hist. Coll. 1st ser. Vol. X.
- p. 108. [38.] Rebecca, wife of Isaac Fowle, o. c. July 30, 1699, adm. f. c. Oct. 1704. Her son Isaac was bap Aug. 6, 1699 (not 92); Nathaniel, bap. Mar. 15, 1701-2; admin. on estate of Isaac Fowle granted to wid. Rebecca, Ap. 26, 1724.
- p. 109. [39.] An excellent original portrait of Mrs. Abigail (Fowle) Smith is in the possession of her great-grandson, Mr. Thomas C. Smith, of Boston. [See Boylston, p. 702.]
- [42.] Rev. William Smith, bap. Feb. 2, 1706-7.
- [44.] Rev. Jacob Norton, b. Feb. 12, 1764, grad. Harv. Coll. 1786, ord. in Weymouth, Oct. 10, 1787, m. (by Rev. Anthony Wibird) Feb. 11, 1789, ELIZABETH CRANCH. She d. Jan. 25, 1811, aged 47, and m. (2d) (by Rev. Dr. Cummings) May 2, 1813, Hannah Bowers, of Billerica. He is now (1854) living, aged 90. Chil.,
1. *Richard Cranch*, b. Mar. 12, 1790, grad. Harv. Coll. 1808; a lawyer of Alexandria, D. C.; m., Sept. 26, 1819, *Mary Cranch*, his cousin, dr. of Hon. William Cranch, of Washington, D. C. [Bright, 46.] He d. Oct. 13, 1821.
 2. *William Smith*, b. Dec. 29, 1791, d. in Portsmouth, N. H., July 19, 1827.
 3. *Jacob Porter*, b. Dec. 16, 1793; a printer; m. Oct. 4, 1818, *Harriet Holbrook*. He d. in Lowell, Dec. 1, 1846.
 4. *Edward*, b. Oct. 26, 1795, d. Dec. 29, 1814, in Dartmoor Prison, Eng., a prisoner of war.
 5. *Thomas Boylston Adams*, b. Feb. 17, 1799; a watchmaker; d. in Fayetteville, N. C. July 23, 1831.
 6. *Elizabeth Cranch*, b. May 28, 1802.
 7. *Mary Cranch*, b. May 19, 1804, m., in 1830, *Jacob Howe*, of Haverhill, Mass. She d. Nov. 3, 1841.

8. *Lucy Ann*, b. May 13, 1806, m., May 29, 1834, Thomas Eames, of Billerica, Mass.
- p. 110. [68.] For 1730-1, read 1720-1. Inventory of the estate of Henry Fowle, mariner, of Charlestown, dated Ap. 2, 1724, £172 2s. 3d. "Lost at sea, as it is supposed, not being heard of for above three years past." His wid. Bethia adm. f. c. Feb. 16, 1728-9.
- [70.] Nathaniel Bright, Sen., selectman, 1701, 17, 23.
- [74.] Nathaniel Bright, Jr., d. Dec. 14, 1737.
- [75.] John Bright, constable, 1735, Selectman, 1746, d. Ap. 22, 1754 (or 5). His wife, Rebecca, d. June 20, 1736.
- [82.] See Trowbridge, in Part II.
- [82-2.] Elizabeth Bright d. Aug. 27, 1741, aged 27.
- [84.] Henry Bright, Jr., d. Nov. 13, 1745.
- [85.] Benjamin Bright d. Feb. 10, 1766.
- p. 11. [86.] In 1754, Silas Bright was a member of Christ Church, Boston.
- [94.] Joseph Bright d. July 3, 1748, and his wid. Elizabeth d. Aug. 17, 1754, and the estate divided 1755. [98.] For May 12, read 21.
- [100.] For Mar. 14, read 13.
- [103.] Will of Wid. Rachel Bright, dated May 21, 1805. [105.] For Sept., read Feb.
- [107.] For Wellington [71-2] read [124-2.] [108.] For Sept., read Ap.
- p. 112. [115.] For 1815, read 1813. [117.] Lieut. Nathaniel Bright, Selectman, 1782-84.

BROOKS.—(1.) THOMAS BROOKS.* Neither the date of his arrival, nor the place of his embarkation has been ascertained; but there is reason to suppose that he came from London. He first settled in Watertown, and was one of the "townsmen then inhabiting," to whom the Beaver Brook plowlands were granted in 1636. He was adm. freeman, Dec. 7, 1636, while he resided in Watertown. It is evident that he could not be the Thomas Brooke who embarked in May, 1635, then aged twenty, in company with Rev. Peter Bulkley. The second son, perhaps the third child, of Capt. Thomas Brooks, of Concord, was born 1632, when the other Thomas was only 17 years old. He moved very soon from Watertown to Concord, of which he was captain, and he received various other appointments of honour and trust. The General Court appointed him constable of Concord, Dec. 8, 1638, and he was representative in 1642, '43, '44, and four years after 1650. In 1640, he was appriizer of horses, cattle, &c., for the purpose of taxation, and appointed to prevent drunkenness among the Indians. In 1657, he purchased of the commissioners of the General Court, for £5, the right of carrying on the fur trade in Concord. In 1660, he and his son-in-law, Timothy Wheeler, jointly purchased of Edward Collins, 400 acres in Medford for £404, two-thirds for himself, and one-third for Wheeler. His wife GRACE d. May 12, 1664, and the next Oct. 22, he sold his house-lot in Concord; but he remained in Concord, and died there May 21, 1667, intestate. His inventory, by Dea. Merriam, Dea. Potter, and George Wheeler, amounted to £448 3s., and his debts to £26 5s. 2d. His three sons and son-in-law presented the Inventory for probate, June 16, 1667, and the next day signed the following agreement.

"Whereas Thomas Brooks, of Concord, has left an estate, and the sons of the said Thomas, not willing to trouble the Court, have jointly agreed as followeth: 1st. That the Inventory taken by Dea. Merriam, Dea. Potter, and George Wheeler shall be accounted the full estate of Thomas Brooks. 2d. We do agree that Joshua Brooks shall have a full double portion out of the lands at Medford, and that the three other sons, Capt. Timothy Wheeler, Caleb Brooks, and Gershom Brooks, to have equal portions, only Caleb and Gershom are to have the remainder of the said lands, after Joshua is first accommodated, as a part of their portion, and Timothy Wheeler out of the movable estate, and all to be distributed by [to] them by those three parties

* As Capt. Thomas Brooks first settled in Watertown, and as there are numerous alliances between his descendants and other families in this volume, we insert the following genealogy, although it cannot with propriety be called a Watertown family. This Genealogy is very deficient in some parts.—much less copious and satisfactory, especially in the issue of his eldest son, than it may be made by careful research, and by a ready co-operation of those who are able to aid in the undertaking. For our materials we are chiefly indebted to the researches of Mr. William G. Brooks [173], of Boston. He is still prosecuting his researches, and any contribution from any source will be thankfully received. We hope that what is here presented will awaken attention, and an increased interest in the subject.

that took the Inventory; unto whose final determination we do severally bind ourselves in a bond of £100 apiece, to stand unto us. We do impress by our hands to this present writing the 17th June, 1667.

Signed in presence of
HUGH MASON,
JOSEPH EASTERBROOK.

(Signed)

TIMOTHY WHEELER.
JOSHUA BROOKS.
CALEB BROOKS.
GERSHOM BROOKS."

Chil. of Capt. Thomas and Grace Brooks,

-
6. 2 1. JOSHUA.
28. 3 2. CALEB, b. 1632.
35. 4 3. GERSHOM.
42. 5 4. MARY, probably the oldest child, m. Capt. TIMOTHY WHEELER.
5. (?) HANNAH, m. Dec. 13, 1647, THOMAS FOX. [See FOX, Part II.]
-
2. 6 (II.) Dea. JOSHUA BROOKS, a tanner, m. in Wat., Oct. 17, 1653, HANNAH MASON, dr. of Capt. Hugh Mason. [Mason 2.] He settled in that south part of Concord which became a part of Lincoln, and, it is supposed, sold his paternal estate in Medford to his brother Caleb. It is conjectured that he learned his trade of Capt. Mason, and, soon after, married his daughter. He was adm. freeman May 26, 1652. Chil.,
-
- 7 1. HANNAH, m. in Wat., Jan. 15, 1677-8, BENJAMIN PIERCE, of Wat. [Pierce, 21.]
8 chil.
8 2. JOHN, b. 1657; m., Nov. 8, 1682, DEBORAH GARFIELD, b. about 1662, dr. of Samuel and Mary (Benfield) Garfield, of Wat. [Garfield, 24-7.] He d. May 18, 1697.
45. 9 3. NOAH, of Concord.
4. GRACE, b. Mar. 10, 1660-1; m., Dec. 6, 1686, JUDAH POTTER, son of Luke Potter, one of the first settlers of Concord. He was burnt in his dwelling, June 20, 1731; and his wid. Grace, d. in 1753, aged 93. This family have been remarkable for longevity. Chil.,
10 1. Eunice, b. Dec. 18, 1688. 2. Hannah, b. Dec. 20, 1690.
12 3. Luke, b. Mar. 10, 1693; d. Sept. 25, 1784, aged 91.
13 4. Mary, b. Sept. 1, 1696.
14 5. Samuel, b. June 6, 1705; d. Feb. 15, 1795, aged 90.
54. 15 5. DANIEL, b. Nov. 15, 1663.
6. THOMAS, b. Sept. 9, 1666; d. Sept. 9, 1671.
16 7. ESTHER, b. July 4, 1668; m., Aug. 17, 1692, BENJAMIN WHITTEMORE, b. Sept. 1, 1669, son of John and Mary (Upham) Whittemore, of Charlestown. He d. Sept. 8, 1734. [See Whittemore, in Part II.] Chil.,
17 1. Benjamin, b. Ap. 9, 1696; of Concord; m., June 15, 1726, *Rukamah Locke*. [Locke Fam., p. 34.] 4 chil. He d. Oct. 22, 1734; and his wid. m. in 1735, John Bond, of Lex. [Bond, 98.]
18 2. Nathaniel.
19 3. Aaron, b. 1711; grad. Harv. Coll., 1734; ord. at Pembroke, N. H., 1737, d. 1767.
20 8. ELIZABETH, b. Dec. 16, 1672; m., Dec. 7, 1705, EBENEZER MERRIAM.
21 9. JOB, b. July 26, 1675; d. May 18, 1697, aged 22, unm. Inventory £94; his brother Noah, exec'r of his Will. By a deed, dated Aug. 24, 1697, Noah Brooks, Daniel Brooks, Sen., Joseph Brooks, Sen., Benjamin Pierce, of Wat., Benjamin Whittemore, and Judah Potter, of Concord, convey to brother Hugh Brooks, all right in the estate of our brother Job Brooks, had of our father Joshua Brooks, deceased.
22 10. HUGH, b. Jan. 1, 1677; of Concord; m., Ap. 9, 1701, ABIGAIL BARKER. He d. Jan. 18, 1746, aged 70 [gravestone]. His brother Noah, was his guardian in 1697.
22 1. Abigail, b. May 15, 1703.
24 2. Jonathan, b. Jan. 8, 1704-5; m., Nov. 17, 1747, *Lucy Percey*.
25 3. Sarah, b. July 23, 1711; m., Mar. 9, 1745, *Edward Garfield*. [33.]

- 26 4. *Mary*, b. July 11, 1714; m., *James Hapgood*.
65. 27 11. JOSEPH, b. 1681.
-
3. 28 (II.) CALEB BROOKS, m. (1st), Ap. 10, 1660, SUSANNA ATKINSON, b. Ap. 28, 1641, dr. of Thomas Atkinson, of Concord. She d. in Concord, Jan. 19, 1669; and he m. (2d), HANNAH ———, supposed to be a sister of his first wife, and b. Mar. 5, 1643-4. He lived in Concord until 1680, when he moved to Medford, and occupied most of the land purchased by his father, and supposed to have been sold to him by his brother Joshua. He d. in Medford, July 29, 1696, aged 64. Admin. granted to his sons Ebenezer and Samuel, Aug. 29, 1696. Inventory £6300 14. Settlement of the estate signed by (wid.) Hannah, Ebenezer, Samuel, Nathaniel Ball, and Sarah. The estate in Medford, is still held by his descendants.
-
- 29 1. SUSANNAH, b. Dec. 27, 1661; d. in Medford, Oct. 23, 1686, aged 25.
2. MARY, b. Nov. 18, 1663; d. 1664.
30 3. MARY, b. —; m., NATHANIEL BALL.
31 4. REBECCA, b. Nov. 9, 1667; d. before her father, unm.
32 5. SARAH, b. Dec. 16, 1668, survived her father, and d. unm.
(By 2d wife Hannah.)
- 80.33 6. EBENEZER, b. Feb. 24, 1670-1.
89.34 7. SAMUEL, b. Sept. 1, 1672.
-
4. 35 (II.) GERSHOM BROOKS, of Concord; m., Mar. 12, 1667, HANNAH ECKLES, 2d dr. of Richard and Mary Eckles, of Cambridge. He took the oath of fidelity, 1672. He d. 1686, and his wid. d. June 2, 1716.
-
- 36 1. MARY, b. May 6, 1667; m., in Rox., May 27, 1690, EDWARD BRIDGE, b. Sept. 9, 1668, son of John Bridge, of Roxbury.
37 2. HANNAH, b. Mar. 24, 1668-9; d. Dec., 1696.
38 3. JOSEPH, b. Sept. 16, 1671; m., Jan. 31, 1703, ABIGAIL BATEMAN.
39 4. TABITHA, b. Mar. 31, 1674. 5. DANIEL, b. Mar. 14, 1678.
40 6. ELIZABETH, b. June 18, 1680; (?) m., EBENEZER MERRIAM. [See 20.]
-
5. 42 (II.) Capt. TIMOTHY WHEELER, of Concord; m. (1st), JANE ———, by whom he had dr. SARAH, b. June 22, 1640. She d. Feb. 12, 1642-3; and he m. (2d), MARY BROOKS, dr. of Capt. Thomas Brooks. He was a Captain, Rep. of Concord, 18 years, and held other most important trusts in the town affairs. He was an early proprietor of Watertown. Sept. 1, 1657, for £140, he bought the house, and several lots of land belonging to the estate of Dr. Richard Palgrave, of Charlestown. In 1660, he was joint purchaser with his father-in-law, of a farm of 400 acres in Medford. He gave the ministerial lot to the town. He d. July 10, 1687, aged 86. It is probable that he was not much younger than his father-in-law, Capt. Brooks. Chil.,
-
- 43 1. ELIZABETH, m. 1678, EBENEZER PROUT. [See p. 409, and Prout, in Part II.]
44 2. REBECCA, b. 1666; m., about 1684, JAMES MINOT, b. Sept. 14, 1653, son of Capt. John and Lydia (Butler) Minot, of Dorchester, grad. Harv. Coll., 1675; studied divinity, and preached often for about ten years, but was never ordained, being more devoted to teaching, and the practice of medicine. Relinquishing the clerical profession, he was appointed Justice of the Peace, and a Captain of the militia; was Representative several years, was much employed in various public trusts, and was distinguished for his talents, and for his excellent character. They inherited the homestead of her father. She d. in Concord, Sept. 23, 1734, aged 68; and he d. Sept. 20, 1735, aged 83. They had 10 children, all married. For a full and well-arranged genealogy of their very numerous and respectable descendants, compiled by Lemuel Shattuck, Esq., see Geneal. Reg. I., pp. 173, &c.
-
9. 45 (III.) NOAH BROOKS, of Concord, afterwards of Acton; m., DOROTHY WRIGHT, of Sudbury. He was witness of an Indian deed in 1684, and was Selectman 1702, 4 and 9. When Acton was set off from Concord, and incorpo-

- rated, July 3, 1735, his farm was included in the new town. He d. Feb. 1, 1738, aged 82, and his wid. d. Mar. 15, 1750, aged 90 [gravestones in Concord].
- 46 1. DOROTHY, b. Oct. 18, 1686; m., Mar. 24, 1705, JOSEPH MERRIAM. He d. Dec. 10, 1750, aged 74, leaving 3 sons and 2 daughters.
- 47 2. JOSHUA, b. Oct. 14, 1688; a Deacon of Lincoln; m., Ap. 24, 1713, LYDIA WHEELER. He d. June 26, 1768.
- 48 3. EBENEZER, b. Feb. 14, 1690; of Concord; m., June 17, 1714, SARAH FLETCHER, dr. of Francis Fletcher, of Concord. He moved to Grafton, Mass., where he d. about 1770, leaving 5 sons and 5 drs.
- †49 1. Noah, b. Sept. 25, 1715. 2. Samuel, b. Oct. 13, 1717. 3. Simon.
- †52 4. Joel, b. July 25, 1721. Chil.,
- †53 1. Sarah. 2. Mary. 3. Elizabeth. 4. Peter. 5. Martha. 6. Lucy.
- †59 7. Mary, m. July 28, 1779, Rev. Joseph Farrar. [Gen. Reg. vi. 326.] She is now [1854] living in Petersham, aged 97.
- †60 8. Elijah. 9. Joel. 10. Aaron (4 chil.). 11. Lydia.
- †64 5. Peter. Names of the 5 daughters not ascertained.
- 49 4. SAMUEL, b. May 14, 1694; m., ELIZABETH —.
- 50 5. BENJAMIN, b. Ap. 22, 1698; m., SARAH HEYWOOD.
- 51 6. MARY, b. Jan. 25, 1699—1700; m., TIMOTHY MINOT, her 2d cousin, b. June 18, 1694, son of James and Rebecca (Wheeler) Minot, grad. Harv. Coll., 1718; was a teacher, of Concord. 3 chil. [See Shattuck, p. 244, and General Reg. I., p. 176.]
- 52 7. THOMAS, b. May 18, 1701; m., June 24, 1725, HANNAH DAKIN.
- 53 8. ELIZABETH, b. Feb. 27, 1704; m., Feb. 23, 1728, JOHN MILES, a farmer, of Concord. 8 chil. [For an account of their children and numerous descendants, see Genealogy of the Miles family, pp. 6, &c.]
-
15. 54 (III.) DANIEL BROOKS, of Concord, m., Aug. 9, 1692, ANN MERRIAM. He d. Oct. 18, 1733, aged 69 [gravestone]. His Will, dated Jan. 6, 1728—9, mentions wife Anna, son John, dr. Mary, who m. — Wheeler, dr. Anna (? Hannah), m. — Jones, sons Samuel and Job; the two last executors.
- 1 1. DANIEL, b. June 5, 1693; d. soon.
- 55 2. SAMUEL, b. May 5, 1694; (?) m., in Weston, Sept. 6, 1738, ELIZABETH GARFIELD.
- 56 3. HANNAH (Anna), b. Feb. 21, 1695—6; (?) m., 1716, JOHN JONES. He d. Mar. 12, 1762, aged 72, and she d. 1753. 5 chil.
- 57 4. JOB, b. Ap. 16, 1698 (father of John, and gr. father of Hon. Eleazer Brooks); (?) m., Jan. 26, 1721, ELIZABETH FLAGG. [Flagg 37, in Part II.]
- 58 5. MARY, b. Mar. 2, 1699—1700; m., — WHEELER.
- 59 6. JOHN, b. Feb. 1, 1702. 7. DAVID, b. May 6, 1709.
- 61 8. TIMOTHY, b. Aug. 30, 1711. 9. DANIEL, b. Ap. 19, 1720.
- 63 10. JOSIAH, b. May 21, 1722. 11. ANNA, b. Mar. 20, 1725.
-
27. 65 (III.) JOSEPH BROOKS, m., June 26, 1704, REBECCA BLODGETT. He settled in that part of Concord, which became a part of Lincoln, and where his father had settled. Ap. 3, 1716, he purchased of Isaac Stearns, for £300, two lots of land in the S. W. part of Lexington, amounting to 100 acres. He d. Sept. 17, 1759, aged 78. His wid. Rebecca, d. Jan. 25, 1768. He acquired a respectable estate as a farmer, and while living, was distinguished for his liberality. From him the church in Lincoln received a part of its communion plate; and the town, the meeting-house bell, and a school fund. These, and several other acts of liberality, render his name deserving of lasting remembrance. [Shattuck, p. 317.] The school fund referred to, was in 1761, £388, and the interest of it, is divided among the districts in the same proportion as other school money. His Will, dated May, 1746, mentions chil., Joseph, Nathan, Amos, Jonas, Isaac, James, Mary, Hannah, and Rebecca. Inventory, £1470.
-
- 66 1. MARY, b. 1705; m. — RUSSELL. 2. ABIGAIL, b. 1707.
- 68 3. REBECCA, b. Aug. 28, 1708; m. — BAKER. 4. JOSEPH, b. Oct. 16, 1710.
- 70 5. NATHAN, b. Mar. 1, 1712. 6. AMOS, b. Dec. 20, 1716.
- 72 7. JONAS, b. Oct. 18, 1718. 8. ISAAC, b. Mar. 17, 1720.

- 74 9. JAMES, b. Aug. 6, 1723. 10. HANNAH, m. — RUSSELL.
-
- 78 JOSEPH BROOKS, of Weston (lineage not ascertained, perhaps son of Joseph, 38), m., July 27, 1725, JANE JENNISON, of Sudbury, and had Joseph, b. in Weston, June 14, 1726.
-
33. 80 (III.) EBENEZER BROOKS, of Medford, m., about 1693, ABIGAIL BOYLSTON, dr. of Dr. Thomas and Mary (Gardner) Boylston, of Muddy River (Brookline), and granddr. of Thomas and Ann Boylston, of Watertown. [See Boylston, 23, in Part II.] She was dismissed from Cambridge Church to Medford in 1713. He d. Feb. 11, 1742, aged 72, and his wid. d. May 26, 1756, aged 83. He inherited his father's house and homestead.
-
92. 81 1. CALEB, b. July 8, 1694.
 106. 82 2. EBENEZER, b. Mar. 23, 1698.
 83 3. THOMAS, b. Ap. 8, 1705, d. Nov. 14, 1784, unm. He was a land surveyor, and was representative 1779. He inherited jointly with his brother Samuel the homestead and buildings of his father, and of his grandfather Caleb.
 110. 84 4. SAMUEL, b. 1709.
 85 5. ABIGAIL, m., Oct. 27, 1720, THOMAS OAKES. Chil., 1. *Abigail*, b. Sept. 2, 1721, d. 1728. 2. *Thomas*, b. Jan. 28, 1722-3. 3. *Ebenezer*, b. Sept. 28, 1725. 4. *Caleb*, b. Jan. 13, 1728. 5. *Isaac*, bap. Ap. 18, 1740.
 6. MARY.
 87 7. HANNAH, m. NATHANIEL CHEERER. 8. REBECCA, m. in 1725, SAMUEL PRATT.
-
34. 89 (III.) Capt. SAMUEL BROOKS, of Medford, m. SARAH BOYLSTON, [32] sister of his brother Ebenezer's wife. He d. July 3, 1735, aged 63, and his wid. d. Oct. 16, 1736, aged 56 [gravestones]. He inherited nearly one-half of his father's property in Medford. By his Will, dated Feb. 20, 1733, he gave to his wife Sarah one-half the dwelling-house, barn, and calash-house, his negro man, Bristow, the furniture and one tankard during her life, one-third the horse-cart, and one-third part of the farming utensils. To his dr. Sarah one-half the dwelling-house and barn, one horse, two cows, and five sheep, and tankard after her mother's decease, one third part the silver money, one-third the cattle and swine, and one-third the articles of husbandry. To son Samuel, the house in which he dwells, and the barn, one suit wearing apparel, boot lasses and silver buckles, one-third the silver money, silver-hilted sword and pistols, best saddle and housing, and negro man named Boston, and one third part the cattle and swine. Inventory, £2851, nearly all in landed estate.
-
125. 90 1. SAMUEL, b. Sept. 3, 1700.
 91 2. SARAH, b. Ap. 17, 1702, inherited one-half her father's estate, and m., in 1738, SHEARJASHAB BOURNE, of Scituate. She d. in 1742, leaving one son, *Shearjashab*, b. 1739, of Boston, m., in 1769, *Sarah*, dr. of James Woodworth, of Scituate. 5 daughters. [See Saltonstall 30, in Part II., and Deane's Hist. Scituate, p. 186.]
-
81. 92 (IV.) Capt. CALEB BROOKS, of Medford, m. (1st) MARY WYER. She d. Jan. 11, 1745, aged 54. He m. (2d), Mar. 1, 1749, RUTH ALBREE. He d. Nov. 21, 1766, aged 73, of a cancer, and his wid. Ruth d. May 6, 1793. His Will, dated May 2, 1766, mentions wife Ruth, son Caleb, son John (who is provided for, as wishing to be a physician), drs. Mary Pratt, Abigail Hall, Ruth Secomb, Sarah, Increase, Elizabeth, Hannah, and Ebenezer.
-
- 93 1. MARY, bap. Dec. 26, 1731; m. — PRATT.
 94 2. ABIGAIL, bap. July 22, 1733; m., Oct. 24, 1757, JOSEPH HALL.
 131. 95 3. EBENEZER, bap. May 4, 1735. He d. Sept. 18, 1775.
 96 4. CALEB, bap. Sept. 5, 1736. 5. CALEB, bap. Oct. 5, 1737.
 97 6. REBECCA, bap. July 7, 1739, m., Nov. 6, 1765, SAMUEL HALL.
 98 7. RUTH, bap. Aug. 12, 1741; m., Oct. 23, 1760, JOSEPH SECOMB.
 99 8. SARAH, bap. Nov. 28, 1742.
 135. 100 9. CALEB, bap. Sept. 29, 1745; m., Jan. 1767, MARY KIEDER.
 101 10. INCREASE, bap. Dec. 26, 1746.

(By 2d wife, Ruth.)

- 102 11. THEODORE, b. Jan. 6, 1751.
140. 103 12. JOHN, bap. May 31, 1752; m. LUCY SMITH.
13. JOSEPH, bap. Feb. 24, 1754; d. May 11, 1756.
- 104 14. ELIZABETH, bap. June 26, 1757; m., Dec. 31, 1776, Rev. JACOB BURNAP, of Merrimack, father of Rev. George W. Burnap, of Baltimore.
- 105 15. HANNAH, bap. Feb. 12, 1760, m. Oct. 21, 1794, FRANCIS BURNS.
-
82. 106 (IV.) Dea. EBENEZER BROOKS, of Medford, m. HANNAH —. He d. about 1775.
-
- 107 1. HANNAH, bap. Sept. 22, 1738; m. — LEARNED[? Learned, 71.]
- 108 2. KATHERINE, bap. Feb. 15, 1741; m., May 26, 1768, EBENEZER CUTLER, of Camb.
3. EBENEZER, bap. Sept. 20, 1742, d. Dec. 11, 1746.
4. MEHITABEL, bap. Ap. 4, 1744, d. Nov. 13, 1746.
5. GIBSON, bap. Dec. 29, 1745, d. May 19, 1746.
6. EBENEZER, bap. Nov. 2, 1746, d. 7. THOMAS, bap. Sept. 10, 1749, d. May 27, 1750.
-
84. 110 (IV.) SAMUEL BROOKS, of Medford, m. in Waltham, Ap. 2, 1747, ABIGAIL HASTINGS, of Waltham. [Hastings 40, and see Part II.] He lived on the homestead of his grandfather Caleb. He d. in 1766. His Will was proved Nov. 11, 1766, by his wid. Abigail, who d. Ap. 16, 1777.
-
- 111 1. ABIGAIL, bap. Jan. 20, d. Feb. 21, 1747-8. 2. ABIGAIL, bap. Sept. 5, 1749.
- 112 3. ANNA, bap. Jan. 5, 1750. 4. MARY, bap. Feb. 3, 1753, d. Sept. 20, 1763.
- 113 5. SAMUEL, bap. Nov. 7, 1754.
- 114 6. THOMAS, bap. June 5, 1756, m. in Medford, May 9, 1796, PARNEL BOYLSTON, bap. Dec. 23, 1764, dr. of Richard and Parnell (Foster) Boylston, of Charlestown, where he settled. [Boylston [21] Part II]. Chil.,
1. Thomas. 2. Penuel. 3. Hannah. 4. Samuel. 5. Mary. 6. Foster. 7. Sarah. 8. Ann. 9. John.
- 124 7. ABILAH, bap. Aug. 12, 1759. 8. PHILEMON, bap. Feb. 8, 1761, d. Oct. 16, 1762.
-
90. 125 (IV.) SAMUEL BROOKS, of Medford, m. MARY BOUTWELL. He d. 1768, and his wid. Mary d. May 25, 1772. His Will, dated Sept. 2, 1762, mentions wife Mary (to have, among other articles, the negro girl, Rose, then sick; if she died, then to have Dinah), son Thomas (to have the negro boy, Pompey), son Edward (to have the negro boy, Charlie), son Samuel, and dr. Mary Whitmore. He inherited one-half, and succeeded to the whole of his father's real estate. In the division of the estate, Thomas's share was prized at £4492 17s. 6d., O. T., and Edward's share at £3989 7s. 6d. O. T. Chil.,
-
- 126 1. MARY, bap. Jan. 1, 1728, m. Oct. 1747, WILLIAM WHITMORE.
144. 127 2. SAMUEL, b. Aug. 24, 1729; grad. Harv. Coll. 1749, d. Mar. 21, 1807.
151. 128 3. THOMAS, b. Jan. 6, 1732, a farmer, of Medford.
163. 129 4. EDWARD, b. Nov. 4, 1733; grad. Harv. Coll. 1757, d. May 6, 1781.
- 130 5. JONATHAN, b. Aug. 17, 1735, d. in College, Aug. 28, 1750.
-
95. 131 (V.) EBENEZER BROOKS, of Medford, m. Dec. 28, 1758, SUSANNA THOMPSON, dr. of Thomas and Sarah (Bradshaw) Thompson, descended from Jonathan Thompson, of Charlestown. He d. Sept. 18, 1775, aged 40, and she d. Feb. 7, 1797, aged 63 [gravestones].
-
- 132 1. SUSANNA, b. Sept. 25, 1759. 2. MARY, b. May 11, 1763.
- 133 3. EBENEZER, b. May 4, 1773.
-
100. 135 (V.) CALEB BROOKS, m. Jan. 1, 1767, MARY KIDDER, bap. Jan. 6, 1745, dr. of Samuel Kidder. He was a Lieut. in Isaac Hall's Company, and is said to have been in the Battle of Bunker Hill. Capt. Caleb Brooks, was a witness in the trial of Col. Henley, in 1778. He d. in 1812. Chil.,

- 136 1. REBECCA, b. May 2, 1770. 2. MARY, b. 1773; d. Ap. 14, 1803.
 138 3 MARSHALL, b. Dec. 28, 1776. 4. ABIGAIL, bap. May 24, 1778.

103. 140 (V.) Gov. JOHN BROOKS, studied medicine with Dr. Simon Tuft, of Medford, and commenced medical practice in Reading, where he m. in 1774, LUCY SMITH, and was there commander of a company of minute men, at the commencement of the Revolution. When he went to Boston, to procure medicine for his practice, he engaged an English officer to teach him the military exercise, in this manner, preparing himself for the important military duties that devolved upon him. In military life, he rose to the rank of Major-General, and his military character and services, are too well known to require a recital here. In civil life he sustained successively the office of Representative, Senator, Councilman, U. S. Marshal, for Massachusetts, Elector of President, which last office he held seven times successively, and Governor of Massachusetts. He received his education at the common schools, but in 1787, he received the honorary degree of A.M., at Harvard and Yale; M.D., Harv. 1810, and LL.D., in 1817. He was Pres. M. M. S. He d. Mar. 1, 1825, aged 73. His wife Lucy, d. Sept. 28, 1791, aged 38. In the Medford graveyard, there is a monument erected to his memory by his friends and fellow-citizens. Chil.,
- 141 1. LUCY, b. June 16, 1776; m., GEORGE O'KILL STUART, and d. 1813.
 142 2. ALEXANDER SCAMMELL, b. Oct. 19, 1781; m., SARAH TURNER. He d. Dec. 17, 1836. Chil.,
 †143 1. Lucy, m. May 30, 1843, Edward L. Keys.
 †144 2. John, a midshipman, U. S. Navy; d. June 4, 1843.
 143 3. JOHN, b. May 20, 1783, grad. Harv. Coll., 1805; of U. S. Navy; killed, Sept. 10, 1813, on board Com. Perry's flag-ship, in the Battle of Lake Erie.
127. 144 (V.) SAMUEL BROOKS, grad. Harv. Coll. 1749; settled in Exeter, N. H., where he d. Mar. 21, 1807. He m. (1st), ELIZABETH PYKE. He m. (2d), TIRZA JAMES. Chil.,
- 145 1. OLIVER PYKE, b. Feb. 1752; d. June, 1755.
 2 SAMUEL, b. Oct. 1753; of Exeter; m. MARY GIDDINGS. He d. Mar. 1818. Chil.,
 1. Dorothy, b. 1781; m. John Hutchings, of Natchez.
 2. Elizabeth, b. 1783; m. — Newman, of Natchez.
 3. JOSEPH, b. Ap. 1755; d. Aug., 1775.
 4. ELIZABETH, b. and d. 1660.
 146 5. ELIZABETH, b. Dec. 1760; m. — GLOVER, of Marblehead.
 147 6. WILLIAM, b. 1764; m. TABITHA GLOVER, of Marblehead, 4 sons, and 1 dr.
 148 7. MARY, b. 1767.
 (By 2d wife, Tirza James.)
 149 8. OLIVER, b. 1796; of Philadelphia; m., 1818, ELMIRA LEE, of Philadelphia. 1 dr. She d. in 1826; and he m. (2d) SARAH CORNISH. 10 chil.
 150 9. JAMES EMORY, b. 1799; china merchant, of Philadelphia; m. (1st), in 1825, MARY CHAMBERS, of Philadelphia. She d. in 1832, and he m. (2d), his wife's sister. Chil., 1. Mary Elizabeth. 2. George. (By 2d wife.) 3. Emory. 4. Arthur Gilman. 5. Charles. 6. Fannie. 7. Alexander.
 150‡ 10. ELIZABETH, b. 1801; m., in 1820, JOHN THOMPSON, of Philadelphia.
 1. William. 2. Fannie, m. Dr. Boyhen, of Clinton, N. C.
128. 151 (V.) THOMAS BROOKS, of Medford, inherited the house, and part of the land of his father. He was a surveyor, and Representative. He m. (1st), Feb. 27, 1755, ANNA HALL. She d. Aug. 28, 1757. He m. (2d), Dec. 29, 1762, MERCY TUFTS. Chil.,
- 152 1. NANCY, b. Ap. 6, 1757; m. DR. STEVENS.
 (By 2d wife Mercy.)
 153 2. MERCY, b. Sept. 3, 1763; m. COTTON TUFTS, Jr.; merchant, and postmaster, of Weymouth. Chil., 1. Quincy. 2. Mercy. 3. Susan. 4. Lucy, m. Thomas Tarbell.

- 154 3. JONATHAN, b. Oct. 25, 1765; a tanner, of Medford; m, Sept. 26, 1791, ELIZABETH ALBREE. He d. Mar. 1847, aged 81. Chil.,
 1. *Samuel Reeves*, b. Feb. 1, 1793. 2. *Charles*, b. Oct. 30, 1795.
 3. *Elizabeth*, b. Dec. 9, 1797. 4. *Alfred*, b. July 9, 1801.
 5. *Lucy Ann*, b. Oct. 25, 1810.
- 155 4. SAMUEL, b. Aug. 16, 1767, lost at sea in 1801.
- 156 5. ISAAC, b. Oct. 2, 1770; m., Jan. 26, 1810, MARY AUSTEN, of Charlestown. He d. Oct. 2, 1819.
 1. *Isaac James*, b. June 12, 1812; d. July 10, 1817.
 2. *Isaac Austen*, b. Ap. 13, 1814. 3. *Margaret Austen*, b. July 6, 1817.
- 158 6. SIMON, b. 1775; d. 1805. 7. ABIGAIL, b. Feb. 25, 1779.
- 159 8. WILLIAM, b. Mar. 5, 1781; m. (?), July 5, 1807, ELEANOR FORMAN, of Monmouth, N. P. In 1798, he was allowed to take a middle name, Smith. In 1852, he was residing in Brattleboro, Vt.
 1. *William F.*, b. Aug. 29, 1811. 2. *Horace*, b. Feb. 16, 1815.
 3. *Ellen M.*, b. June 13, 1817. 4. *George I.*, b. Aug. 18, 1818.
 5. *Francis W.*, b. May 14, 1821. 6. *Mary E.*, b. July 13, 1823.
 7. *Lucy T.*, b. Dec. 13, 1825.
- 160 9. THOMAS, b. Jan. 30, 1783. 10. EDWARD, b. June 18, 1786.
- 162 11. JAMES, b. Feb. 7, 1789.
-
129. 163 (V.) Rev. EDWARD BROOKS, grad Harv. Coll. 1757, ordained in North Yarmouth, July 4, 1764; was dismissed in 1769, on account of his having imbibed less stringent Calvinistic sentiments, than some of his church. He returned to Medford, and preached occasionally, but did not take any pastoral charge. In 1777, he was chaplain of the Frigate Hancock, Capt. Manly; was captured and carried to Halifax, where he had the small-pox. He m., Sept. 23, 1764, ABIGAIL BROWN, dr. of Rev. John and Joanna (Cotton) Brown, of Haverhill, grand dr. of Rev. Roland and Elizabeth (Saltonstall) Cotton, of Sandwich, and great grand dr. of Col. Nathaniel and Elizabeth (Ward) Saltonstall, of Haverhill [Saltonstall, 40, Part II.] He d. May 6, 1781, aged 48, and his wid. d. Nov. 29, 1800. Chil.,
168. 164 1. COTTON BROWN, b. in N. Yarmouth, July 20, 1765.
177. 165 2. PETER CHARDON, b. in N. Y., Jan. 6, 1767.
- 166 3. MARY, b. in N. Y., Jan. 27, 1769.
- 167 4. JOANNA COTTON, b. in Medford, May 18, 1772.
-
164. 168 (VI.) COTTON BROWN BROOKS, a merchant, resided in Medford until 1793, in Haverhill, Mass., from that time until 1801, when he moved to Portland, and continued in trade until 1828, and d. there May 12, 1834. He was selectman of Portland several years, and frequently held other offices of trust and honour. He m. (1st) JANE WILLIAMS, dr. of Benjamin and Jane (Gray) Williams. Benjamin Williams was a son of Mascoll Williams, a bookseller and postmaster of Salem, and gr. son of Isaac Williams, who m., in 1716, Sarah Mascoll. His wife Jane was a dr. of Abraham Gray, and a sister of Hon. William Gray, of Salem, afterwards of Boston. She d. Jan. 23, 1828, aged 60, and he m. (2d) Mrs. ANN NOYES, wid. of Jacob Noyes, of Portland. She is still (1855) living in Portland. Chil.,
- 169 1. CHARLES, b. in Haverhill, Sept. 3, 1795, of Boston; m., Aug. 29, 1824, NANCY DICKS, of Portland.
- 170 2. GEORGE, b. in H., Aug. 5, 1797; m., Nov. 16, 1825, HENRIETTA TRACY, of Newburyport. He d. in Portland, Aug. 8, 1837.
- 171 3. JANE, b. in H., Nov. 15, 1799; m., May 21, 1822, FRANKLIN TINKHAM, of Portland. She d. Jan. 6, 1827.
- 172 4. THOMAS BROWN, b. in Portland, May 22, 1802; m., June 29, 1827, ELIZABETH A. GORDON, of Belfast; resides in Hallowell, Me.
- 173 5. WILLIAM GRAY, b. in P., Oct. 12, 1805; a merchant, of Boston; m., Sept. 9, 1833, MARY ANN PHILLIPS, of Andover; [Phillips, 211, Part II.] See note p. 719.
- 174 6. EDWARD COTTON, b. in P., Oct. 20, 1806, d. Oct. 12, 1807.
- 175 7. JOHN COTTON, b. in P., July 1, 1809; m. (1st), Feb. 9, 1839, MARTHA HEATH, of Warren, Me. She d. Sept. 16, 1840, and he m. (2d), Feb. 2, 1842, MARTHA

- SWIFT, of Portland. She d. Feb. 9, 1845, and he m. (3d) CAROLINE PARRIS, of Portland.
- 176 8. JOANNA COTTON, b. in P., Aug. 21, 1811; m., Jan. 2, 1839, Dr. WILLIAM SWASEY, of Limerick, Me.
-
165. 177 (VI.) Hon. PETER CHARDON BROOKS, an insurance broker and capitalist of Boston, m., Nov. 26, 1792, ANNA GORHAM, dr. of Hon. Nathaniel Gorham, of Charlestown. He d. Jan. 1, 1849, aged 82. For a copious and elegantly-written memoir of his life—his unspotted virtue, his winning manners in social life, his public services and practical benevolence, his rare sagacity and great success in business, see *Geneal. Reg.* for Oct. 1854, and Jan. 1855; also, "God with the Aged; a Sermon preached to the First Church [of Boston], 7 January, 1849, the Sunday after the death of Hon. P. C. Brooks." By Nathaniel L. Frothingham, D.D. He was repeatedly Representative and Senator in the State Legislature, a member of the Governor's Council, and a member of the State Convention that revised the Constitution in 1820. Chil.,
- 178 1. EDWARD, b. Dec. 22, 1793; m. ELIZA BOOT, of Boston.
- 179 2. GORHAM, b. Feb. 10, 1795; m. ELLEN SHEPHERD, of Boston.
3. PETER CHARDON, b. July 4, 1796, d. Feb. 11, 1798.
- 180 4. ANN GORHAM, b. Feb. 19, 1797; m. Rev. N. L. FROTHINGHAM, D.D., of Boston.
- 181 5. PETER CHARDON, b. Aug. 26, 1798; m. SUSAN CLEVELAND.
- 182 6. SIDNEY, b. Oct. 7, 1799; m. FANNY DEHON, of Boston.
- 183 7. CHARLOTTE GRAY, b. Nov. 4, 1800; m. Hon. EDWARD EVERETT.
- 184 8. WARD CHIPMAN, b. Ap. 21, 1804, d. Mar. 19, 1828.
9. ABIGAIL BROWNE, b. Jan. 22, 1806, d. June 16, 1807.
- 185 10. HENRY, b. Feb. 9, 1807, d. Sept. 2, 1833.
- 186 11. ABIGAIL BROWNE, b. Ap. 25, 1808; m. CHARLES FRANCIS ADAMS, Esq.
- 187 12. HORATIO, b. Sept. 20, 1809, d. May 14, 1843.
13. OCTAVIUS, b. Oct. 27, 1813, d. Dec. 26, 1822.

p. 119. **BROWNE.**—[6-1.] See Woodward [11.], in Part II.

[7.] Jonathan Brown was town clerk and constable in 1678, and selectman 1686.

p. 120. [11.] Nov. 7, 1692, Abraham Brown, and wife Mary, for £40, sold to James Bigelow (his brother-in-law) the 107 acres farm land which was originally granted to his grandfather, Abraham Browne, Sen.

[18.] Captain Abraham Brown built and occupied the house since known as the Esq. Jonathan Brown house, which passed to his son, Major Adam Brown, and is now occupied by his heirs. It is probably not less than 160 years old.

Abm Brown

p. 121. [52.] Sarah Brown. See Thomas Hammond [141], in Part II.

p. 122. [54.] Mar. 22, 1633-4, James Haiewood, aged 22, and Judith Phippin, aged 16, both of the parish of Stepney, obtained a certificate in order to embark in the Planter, for New England, and were among the very early settlers of Woburn. The record of their marriage (of which there is no doubt) has not been discovered. He d. Nov. 20, 1642, and had a posthumous dr. Rebecca, b. Dec. 4, 1642. [Was it their eldest daughter, Judith "Howard," who m. in Woburn June 1, 1689, Samuel Walker?] His wid., Judith, m. (2d) Jan. 18, 1643-4, William Simonds, of Woburn, by whom she had 12 children, viz., 1. Sarah, 2. Judith. 3. Mary. 4. Caleb. 5. William. 6. Joseph, b. Oct. 18, 1652. 7. Benjamin. 8. Tabitha, d. in infancy. 9. Joshua, d. in infancy. 10. James. 11. Bethiah. 12. Huldah. The father, William, d. June 7, 1672. Their 3d son, Joseph Simonds, a carpenter, was of Woburn until 1679, and went to Camb. Farms (Lex.) previous to 1687. He and his wife Mary were the 22d and 23d in the order of admission to Lexington Church, where their dr. Elizabeth was bap., Nov. 13, 1698. This Elizabeth m. Jonathan Brown [54] of Watertown.

[58.] In the margin, for 115, read 125.

[60.] Samuel Brown, of the E. Precinct (Wat.), was adm. f. c. to Waltham Church, Mar. 21, 1724-5, and his wife Mercy was admitted Ap. 9, 1724. They were both dismissed from Waltham to Leicester Church, Feb. 18, 1738-9.

Saml Brown

- p. 124. [77.] From 11th line strike out,
we think. Samuel Adams, Sen., d.
 Mar. 8, 1748.

Autograph of Capt. John Brown.

- p. 125. [99.] Abigail (Brown) Myrick, d. 1813, aged 85.

- p. 126 [110.] Rev. STEPHEN FARRAR,* b. Sept. 8, 1738, son of Dea. Samuel and Lydia (Barrett) Farrar, of Lincoln, grad. Harv. Coll. 1755, began to preach in New Ipswich, N. H., in the winter of 1758-9, was invited the next November to settle there, and was ordained Oct. 22, 1760. He continued to be the pastor and the only one of the town, until his decease, June 23, 1809. [See Farrar Family; also, Hist. of N. Ipswich, pp. 358, &c.] He m. Nov. 29, 1764, EUNICE BROWN, dr. of Isaac and Mary (Balch) Brown, of Waltham, Mass. She d. Sept. 9, 1818, aged 74. [Brown, 110.]
1. EUNICE, b. Aug. 18, d. Sept. 3, 1765.
 2. STEPHEN, b. Aug. 17, 1766, of Groton, Mass., d. in New Ipswich, Oct. 14, 1829; m., Oct. 11, 1795, NANCY MORSE. Chil.,
 1. *Louisa*, b. 1797; m. 1815, *Daniel Smith*. Chil.,
 1. Daniel, m. 2. John. 3. Leonard.
 2. *Ann*, b. Ap. 1800.
 3. *Laura*, b. Nov. 24, 1802; m. Sept. 23, 1826, *Jabez Pratt*, of Boston, coroner. Chil.,
 1. George Washington, b. Mar. 10, 1828. 2. Joseph Warren, b. Nov. 14, 1829.
 4. *Mary Ann*, b. Mar. 2, 1804; m. *John Higgins*. Chil.,
 1. Franklin. 2. Warren.
 5. *Stephen Franklin*, b. 1806, of Hillsboro, N. H.; m. *Catherins Jones*.
 6. *John Morse*, b. 1815, a trader.
 7. *George*, b. 1817, grad. Westl. Univ. 1849; a partner in trade with his brother, John M.
 8. *Prentice*, b. 1819, d. 1820.
 3. EUNICE, b. Feb. 26, 1768; m. JOHN JONES, and settled in or near Augusta, Me., where he d. early, and his wid. and five chil. returned to live with her father. She d. May, 1838. Chil.,
 1. *Stephen*, grad. Yale Coll. 1812, and d. a few years afterwards in S. Carolina.
 2. *Mary*, unm. 3. *John*, d. 4. *Peter*, d. 5. *James*, d.
 4. JAMES, b. June 23, 1769; m. (1st) SALLY H. —, and m. (2d) AMINTA TURELL.
 5. ISAAC BROWN, b. Mar. 27, 1771; m. ANNA, dr. of Dr. Ebenezer Lawrence, of Pepperill. [J. Lawrence, 212, Part. II.] He lived several years in New Ipswich, afterwards moved to Fairfax, Vt., where he d. 1838. Chil.,
 1. *Ebenezer Lawrence*, a merchant, of Burlington, Vt.
 2. *Stephen*, m. his cousin, Anna Muzzy. [50.]
 3. *Ephraim Heartwell*, grad. Mid. Coll. 1831; a teacher and a farmer of Fairfax, Vt., until 1846; now (1853), a manufacturer of fire-bricks at Vergennes, Vt.
 4. *Isaac*, m. his cousin, *Eveline Farrar*. [43.]
 5. 3 other chil.
 6. SAMUEL, b. June 30, 1772, grad. Harv. Coll. 1793; m. — DEMING. He d. 1840. She d. 1846. 14 children.

* LINEAGE OF REV. STEPHEN FARRAR.

- (1 Gen.) JACOB and ANN FARRAR, of Lancaster, from Eng.
 (2) JACOB, Jr., b. in England; of Lancaster, Mass., killed in King Philip's War, Aug. 22, 1675; m. 1668, Hannah, dr. of Geo. Hayward, of Concord.
 (3) GEORGE, b. Aug. 16, 1670, of Concord (Lincoln), m. Sept. 9, 1692, Mary Howe. He d. May 16, 1760. She d. Ap. 12, 1761.
 (4) SAMUEL, b. Sept. 28, 1708, of Lincoln; m., Jan. 13, 1731-2, Lydia Barrett. He d. Ap. 17, 1783. Chil. of Dea. Samuel and Lydia.
 1. Lydia, b. Sept. 2, 1735; m., Mar. 6, 1755, William Bond (Bond 126).
 2. Samuel, b. Feb. 14, 1737; m., Feb. 13, 1772, Mercy Hoar (Hoar 37, by mistake printed Mary.) [See Farrar Fam., p. 12.]
 3. Stephen, b. Sept. 8, 1738, grad. Harv. Coll. 1755. [See above, in the text.]
 4. James, b. July 24, 1741; d. in New Ipswich, July 11, 1767.
 5. Rebecca, b. Aug. 13, 1743; m. Nov. 29, 1764, Dr. John Preston, of N. Ipswich.
 6. Lucy, b. Ap. 27, 1746; m., Ap. 26, 1770, Humphry Farrar, her cousin.
 7. Timothy, b. June 28, 1747, grad. Harv. Coll. 1767, LL.D. 1847; d. Feb. 21, 1840. [See Farrar Fam., p. 14, &c., also, J. Lawrence (53-5) in Part II.]
 8. Mary, b. July 6, 1754; d. Sept. 2, 1756.

- 23 7. PRENTICE, b. Nov. 12, 1773; m. ELIZABETH OSGOOD, of Rutland, Vt., and d. in Canada, Feb. 1837. 7 children.
- 24 8. MARY, b. June 26, 1775; m. SAMUEL DAKIN, Esq., grad. Dart. Coll. 1797; a lawyer, of Jaffrey, N. H. He afterwards moved to the interior of N. Y. state, where he d., and where his wid. resides. 5 chil., one of whom, Samuel, is a lawyer and banker in N. Y. city.
- 26 9. MOSES, b. Mar. 12, 1777; m. ELICIA TURELL, and d. 1815. 3 children.
- 27 10. LYDIA, b. Dec. 30, 1778; m., Mar. 6, 1800, Rev. WARREN PIERCE, b. Mar. 28, 1776, grad. Dart. Coll. 1799; d. 1822. Chil.,
- 28 1. *Zenophon*, b. 1800, in N. Ipswich; d. July 1811.
- 28 2. *Augustus*, b. Mar. 13, 1802, grad. Harv. Coll. 1820; M.D. Bowd. Coll. 1825; M.M.S.S.; settled in Tyngsboro, and d. 1849; m., Dec. 23, 1824, *Mary Messer Clarke*. Chil.,
- 29 1. Eliza Shattuck, b. Sept. 23, 1825.
- 30 2. Fred. Augustus, b. Aug. 11, 1827; m., Oct. 30, 1850, Mary Pitts Bridge, of Boston.
- 31 3. Mary Jane, b. Sept. 10, 1829.
- 32 3. *Charles*, b. Mar. 12, 1804; grad. Dart. Coll. 1825; d. Feb. 1852; m. (1st) Nov. 9, 1828, *Susan Ruggles Rutter*. 3 chil. He m. (2d) *Harriet A. Horton*. 5 chil.
- 34 1. Charles Maynard, b. Nov. 7, 1830. 2. Edward Augustus, b. Nov. 19, 1831.
- 36 4. *Frederick*, b. Nov. 17, 1805; m., Jan. 1, 1833, *Ermina Merriam*. 6 chil.
- 37 5. *George*, b. Feb. 5, 1808.
- 38 6. *Stephen Farrar*, b. Oct. 20, 1809; d. Mar. 1837, unm.
- 39 7. *Lydia Ann*, b. Aug. 27, 1811; m., Oct. 16, 1833, *Seth C. Smith*. 4 chil.
- 40 8. *Harriet Maria*, b. Sept. 21, 1813; m., Mar. 27, 1840, *George Osgood*.
- 41 1. Warren Pierce, b. Aug. 14, 1844.
- 41 2. Charles, b. 16, d. 30 Aug. 1849.
- 41 9. *Joseph Warren*, b. June 18, 1817; m., Dec. 25, 1845, *Olive Augusta Eiles*.
- 42 11. CALEB, b. June, 1780; m., Mar. 15, 1804, SARAH PARKER, and resides in Middlebury, Vt. Chil.,
- 43 1. *Eveline*, m. her cousin, *Isaac Farrar*, [18,] of Fairfax, Vt.
- 44 2. *Clarissa*, m. *Daniel West*, of New Haven, Vt.
- 45 3. *Henry B.*, lives in North Carolina.
- 46 4. *Martha*, m. *Philander Hathaway*, a trader, of Manchester, N. H.
- 47 5. *George*, a trader, of Manchester, N. H., of the firm of Farrar and Hathaway.
- 48 12. NANCY, b. Jan. 24, 1782; m. (1st) 1802, JOHN MUZZY; m. (2d) — HODGKINS; and m. (3d) — LOVEGROVE. Chil. by 1st husband,
- 49 1. *John*, b. 1803, m. 2. *Caroline*, b. 1806, m. *James Saunders*.
- 50 3. *Anna*, b. 1807; m. her cousin, *Stephen Farrar* [16].
- 51 4. *Hannah*, b. 1809; m. *Amariah Whipple*, of Worcester.
- 52 5. *Harriet*, b. 1810; m. *James Reed*, of Rye, N. H.
- 53 6. *Mary*, b. 1812; m.
- 54 13. EPHRAIM HARTWELL, b. Dec. 8, 1783; a teacher, several years, in Boston, a trader, town clerk, and magistrate of New Ipswich, N. H., occupying his father's homestead; m. in 1826, PHEBE (Parker) CHAMPNEY, wid. of Jonas C. Champney, and sister of his brother Caleb's wife. He d. Jan. 8, 1851, leaving a daughter, Sarah Eunice, b. 1827, unm. [See Hist. of New Ipswich, pp. 319-20].
- 55

[111.] For James Warner, read Warren. Hon. Moses Brown, then a captain, was in active service on Long Island, and at White Plains, and was in the Battle of Trenton. He kept school in Weston, in the winter of 1769-70. He was the projector of the Boston and Salem turnpike.

p. 127. [113-2.] Charles Henry Brown, d. abroad July 31, 1852.

[114.] Mrs. Mary (Brown) Hartwell, d. July 11, 1846. [115.] Sarah, d. aged 6 mos.

[116.] For Ipswich, N. H., read Groton, Mass.

[117.] For Jan. 15, 1774, read Jan. 16, 1775.

[119-7.] For, and has chil., read s. p.

[121½.] Aaron Brown had, 10. Anna, b. Jan. 12, 1801, now (1853) living, unm.

[117.] Capt. *Jonathan Brown*, Esq., whose company, at Lake George, belonged to the Regiment of Col. William Williams [2], was a member of the 1st Provincial Congress, held at Salem, Oct. 7, 1774; was one of the committee, appointed Oct. 13th, to

- wait on Gov. Thomas Gage; was appointed, Dec. 6th, one of the committee to correspond with the inhabitants of Canada; Dec. 9th, on the committee to thank the proprietors of the meeting-house, for its use by the Congress. He was a member of the 2d Provincial Congress, held at Cambridge, Feb. 1, 1775; was appointed, Ap. 12th, on the committee of correspondence with the committees of various towns. He was a member of the 3d Provincial Congress, held at Watertown, May 31, 1775, and during June and July, he was appointed a member of numerous committees, besides several orders to him individually, to perform public services. He was selectman, 1765, 66, 67, 68, 69, 70, 76, 77, 78, 79, 80.
- p. 128. [137.] Eli Jones is supposed to be the son of that Eli Jones who m., in 1754, Mary, wid. of Jonathan Gilson, and d. in 1761.
- p. 131. [152-2.] 2. LYDIA L., b. Feb. 23, 1785; m., May 8, 1809, DAVID BRINSMADE, of Le Roy, N. Y., who was b. Oct. 8, 1782; d. Ap. 10, 1837. Chil.,
1. *Albert Lawrence*, b. Feb. 2, 1810; m., Feb. 1839, *Martha Belden*, and settled in Mishawaka, Ia. Chil.,
 1. Henry. 2. Lydia. 3. Louisa.
 2. *Louisa*, b. Jan. 23, 1812; d. Ap. 24, 1814.
 3. *Abigail Charlotte*, b. June 1, 1814; d. Sept. 20, 1841.
 4. *Henry*, b. Nov. 20, 1815; m., Oct. 15, 1845, *Susan Alma King*, and settled in Rochester, N. Y. Chil.,
 1. Elizabeth. 2. Dolly. 3. Alma Susan.
 5. *Matilda*, b. Oct. 27, 1817; m., Aug. 23, 1849, *Julius Nelson Wilber*, of Alto, Wis. Chil.,
 1. Charlotte. 2. Amanda. 3. Francis Augustus.
 6. *Charles Grandison*, b. Mar. 19, 1820; m., Oct. 1847, *Mary Jane Bostwick*, and resides in Le Roy, N. Y.
 7. *Amanda Melvina*, b. May 29, 1823; m., Aug. 23, 1849, *Joel Tyler Benedict*, and settled in N. York.
 8. *Louisa Maria*, b. Aug. 26, 1825. 9. *Sophia Jane*, b. May 9, 1827.
- p. 133. [188.] Elisha Jones, d. in Dayton, Feb. 9, 1853.
- p. 134. [216.] For Jacob Wyman, read Daniel.
- [222.] For Jan. 21, read, in Lex. June 22.
- [223.] Mary Brown, d. Aug. 28, 1853, aged 96 y. 2 m. 20 d., unm.
- p. 134. [227.] Relief (Pierce) Brown, d. in Nov. 1850.
- p. 135. [231.] Leonard Brown, m. Adeline Barnes; and his sister Louisa, m. — Clark. For Warner, read Warren.
- [234.] Chil. of Charles and Mary. 6. Ella Maria, b. July, 1849; d. June, 1850. 7. Herbert, b. Nov. 24, 1851.
- [239.] Mrs. Anna (Brown) Farnsworth, d. in Ap. 1850.
- [243.] For [246-7], read [†247].
- p. 136. [248.] Gardner Brown, d. in Sept. 1854, of consumption.
- p. 137. [268-8.] John Mills Brown, M.D., Harv. Coll. 1852, examined by U. S. Navy Board, in Jan. 1853, in Philadelphia, and passed No. 3.
- p. 138. [277.] For [Livermore, 257], read [Livermore, 282].
- [279.] For Sarah Walley, read Sarah Hurd Walley.
- [285.] G. A. and S. S. (Tilden) Gennett, has 8. John Mico, b. Mar. 8, 1852.
- [286.] For May 4, 1804, read 1801. For the lineage of Dr. E. S. Gennett, see Mitchell's Hist. Bridgewater, pp. 166-7.
- p. 139. [288-2.] For Ellen, read Alice Campbell.
- [289.] 2d child, Allen Ramsay, b. Sept. 24, 1851.
- [292.] Josiah Brown, of Boston, d. Mar. 20, 1798.
- [293.] After 1780, read, m., Sept. 25, 1809, Sally Williams Deblois.
- [293-1.] For John Clarke, read John Deblois.
- [293-3.] For Susanna Clarke, read Susan Elizabeth Clarke. She m., Feb. 27, 1854, William H. Vincent, a California merchant, from Dorchester.
- [294.] For (? Wentworth), read Ann Appleton.
- [295 and 296.] For Van Wort, read Van Wart.
- [297.] For Mar. 24, read 25. For Lydia Jackson, read Lydia Cabot Jackson. C. S. and L. C. J. Storrow, have, 7. Lydia, b. Dec. 19, 1850.
- [301.] John Brown, Jr., then of Weston, m. (1st), in Lincoln, Dec. 11, 1765, Hepzibah Wesson. The tradition is that she d. early.
- p. 140. [318.] For Olcott Kennard, read Allcott. He d. Aug. 10, 1853, aged 66.

[319.] Phineas Brown, Esq., was in the Battle of Saratoga, and at intervals served several months during the war. Bottom line, for Stephen Backus, read William Backus. ☞ When page 140 was printed, it was intended to insert a genealogy of the Backus families, as an appendix; but since that time, Mr. William P. Browne, has accumulated so large a mass of materials, that it is now proposed to publish a memorial of the Backus and Stevens families, separately.

Phineas Brown

- p. 141. [323.] Chester F. Brown, has, 5. Hebe Annette, b. Aug. 24, 1852.
 [324.] For Grizette, read Grizelle.
 p. 142. [335.] For Oct. 12, read Oct. 1. Susanna Hobbs, was a dr. of Abram and Sarah (Brown) Hobbs.
 [349.] William P. Browne, Esq., now (1855) resides near Montevallo, Shelby Co., Alabama, engaged in opening and making accessible a coal mine. See above [319]. His dr. Claudia Grace, d. in Philadelphia, Ap. 25, 1853; and he has a son, William Bradford, b. in Philada. Ap. 27, 1853.
 p. 143. [363.] For Welds, read Wells. She was a sister of Margery [Brown, 376].
 p. 144. [376.] Mrs. Margery (Wells) Brown, d. Mar. 1851, aged 88.
 [377.] For Hawkesburg, read Hawkesbury.
 [383.] Marcus A. Brown, m. Ann Robinson, of Hawkesbury.
 [392.] Ormon Brown, resides on the family homestead, at Dalton, Mass.

- p. 145. **JOHN BROWNE.**—It was once thought probable that this John Brown [1], might have been a son of John Browne, of Wat., born the year before he left England, but in a deed recorded in Mid. records, he is called "a Scotchman," and the first John of Wat. left only 2 drs. and widow. John Brown's dr. Deborah m. Jeremiah Meacham, of Salem, and his dr. Elizabeth m. Jan. 10, 1677, John Gustin.
 [2.] For b. 1679, read 1677. Mar. 16, 1698-9, Esther Brown sold to her son, Joseph Brown, a house and 6 acres of land, bounded N.E. and West by John Barnard; S. by highway. Jan. 4, 1708-9, Joseph Brown, cordwainer, of Wat., bought of John Mixer and wife Abigail, a house and 72 acres, bounded E. by Daniel Harrington; W. by Thomas Woolson; N. by Samuel Whitney and John Warren; S. by Thomas Harrington and heirs of William Page. Also, 20 acres, bounded N. by four-mile brook; W. and N. by Daniel Harrington; E. by upland. About 4 months afterward, Ap. 20, 1709, he sold these two lots to Benjamin Garfield. Ap. 28, 1709, he sold to Benoni Garfield 6 A. in West End of Mixer's meadow.
 [3.] Ruhamah, m. David Cormee, and had son David, b. in Lex., July 30, 1719.
 p. 146. [14.] Joseph Brown, Jr., had a fourth child, Jonas, birth not recorded, who m. in Lex., May 28, 1734, Hannah Munroe, b. Mar. 9, 1713, dr. of William, Jr., and Mary (Cutler) Monroe.
 [26.] After Sarah Smith, insert [Smith, 59].
 [28.] For 1732, read 1742.

[There were several families and individuals of the name of Brown, found in the records of Watertown, Waltham, and Weston, not descended from Abraham, and whose lineage has not been ascertained. It is probable that some of them were descended from Thomas Brown, of Cambridge, some of whose descendants settled in Newton, and probably others from the Browns of Sudbury.]

William Brown, wife and family, "lately from Ireland," moved from Boston to Watertown in Oct. 1722, and the next January he occupied "the house Mr. Angier dwelt in," at this time owned by Capt. Abraham Brown, and which Capt. Brown soon after sold to John Stearns. The names of his wife and children are not recorded, nor is it known what became of the family.

Allen Brown, of Boston, and wid. Ruth Coolidge [Coolidge, 56] m. in Wat., Mar. 16, 1731-2; both o. c. Feb. 25, 1732-3, and had dr. Elizabeth, bap. at the same time. His wife Ruth d. Dec. 1, 1736, aged 41. Cornelius Brown, son of Aaron and Ann, b. Ap. 5, bap. Ap. 10, 1743.

David Brown [? Daniel] of Marlboro (perhaps son of John and Esther, p. 145), and Mary Bigelow [24], m., in Wat., Jan. 26, 1699-1700.

Isaac Stone, of Fram., and Elizabeth Brown, of Sud., m. in Wat., July 24, 1722. [See p. 524.]

Jonathan Hartwell and Elizabeth Brown, both of Concord, m. in Wat., Sept. 22, 1713.

- Jonathan Hubbard and Rebecca Brown, both of Concord, m. in Wat., Sept. 26, 1704.
 Samuel Brown and Hepzibah Brown m. in Wat., Dec. 17, 1728, and had dr. Hepzibah, b. Sept. 30, 1729.
 William Brown, of Newton, and Ann Molton, of Wat., m. May 8, 1746. Abijah Brown, son of William, bap. in Wat., Feb. 27, 1756, and Susanna, bap. Jan. 6, 1760.
 Samuel Brown (? son of Robert, of Newton) m. in Wat., Oct. 14, 1765, Lois Coolidge, and both o. c., July 27, 1766. [Was it his wid. or sister, Lois Brown, of Newton, who m. in Waltham, June 21, 1780, Timothy Baker, of Needham]
 1. Jacob, bap. Oct. 17, 1766. 2. Amasa, bap. June 12, 1768. 3. Elizabeth, bap. July 22, 1770. 4. Anna, bap. Oct. 11, 1772.
 George Brown, son of George and Eunice, bap. in Waltham, Sept. 21, 1766. Sally Brown, dr. of George, bap. in Wat., Aug. 20, 1780. George, son of George, bap. July 21, 1782. Charles, son of George, bap. Feb. 6, 1785.
 Jonathan Locke, of Tyringham, and Abigail Brown, of Waltham, m. in W., Aug. 1, 1776.
 Lieut. John Powell and Polly Brown m. in Weston, May 27, 1779.
 John and Lydia Brown had Lydia, Joseph, and Mary, bap. in Weston, Nov. 7, 1714, and Obadiah, bap. Sept. 7, 1718.
 Edward Richardson, of Jay, Me., and Sally Brown, m. in Wat., Sept. 6, 1801.
 Moses Stone and Betsey Brown, m. in Wat., Sept. 8, 1802.
 Enoch Brown and Jemima Mills, m. in Waltham, Oct. 13, 1803.
 Nathan Brown, of Lincoln (lineage not ascertained), m. (1st) Mary, dr. of George and Mary (Barrett) Farrar. She d. Sept. 29, 1759, and he m. (2d) May 22, 1760, Mary, wid. of Isaac Brown [109] of Waltham, where he resided some time, and was assessor in 1761. He returned to Lincoln, and d. there, Oct. 13, 1781. [See General Reg. I., p. 256.]

p. 147. **BUCKS.** For Bucks, read Rucks. See Rucks, in Part II.

BULL.—In first line, for 1656, read 1652. William Bull, of Wat., was a son of William Bull, of Cambridge. In a suit, in 1683, he is called "William Bull, Jr."

BULLARD.—June 17, 1679. Testimony of Mary Bullard (wife of William Bullard, of Charlestown [father of Nathaniel], formerly wife of Francis Grise " world], of Charlestown, whose Inventory was dated Nov. 9, 1652), "Th married, I told my husband (Wm. B.) I had two children, and an G.) Wm. Bullard and wife Mary had belonged to Camb. Chr

- [2.] It is supposed that Benjamin Bullard was a brother of Robert of Maudlin and Anne. When he (B. B.) demanded of his father-in-law, Thorpe, the selectmen say, Mar. 29, 1672 Thorpe, at his decease, was Bullard's, and his two sisters' but the use of the estate was Goodman Whittacar's till Nov. 1
 [3.] George Bullard m. (1st) Beatrice Hall, of Boston. "Beat George Bulward, of Watertown," was dismissed from the First 17, 1644. Ap. 4, 1644, George Bulward, of Wat., sold to The stall, a house and 8 acres, bounded west by John Knolls; E. by highway; N. by Maudlin and Anna Bullward. This was in the list of possessions, 1642-4. At a meeting of the selectmen was ordered that John Ball, son-in-law, and Jonathan Bullard notified of the necessity of help for father Bullard and his wife.

p. 148. [4.] JACOB BULLARD, was in Wat. in 1680, when John Nevinson brought a suit against him; and in 1683, when John Nevinson brought a suit against him for slander. At a meeting of the selectmen, Jan. 30, 1709-10, ordered that the selectmen address the Judges of the Supreme Court, concerning Jacob Bullard, an aged blind person, who is unhappily sent from another province. He was buried Nov. 21, 1715.

[4.] Strike out (?), also (supposed his dr.).

[11.] Strike out (?). Abigail, 3d child of Joseph and Elizabeth Bullard, m. Abraham Bigelow, of Weston. [Bigelow, 140.] [Mar. 5, 1706-7, Joseph Bullard, of Wat., miller, sold to Francis Fulham, 1 acre in Eddy's Farm, south side Sudbury road, late of Alexander Miller, of Piscataqua; bounded W. by F. Fulham; N. by Samuel Jones, and Jonathan Bullard, Sen.; E. by J. B.; S. by Land of Contention; the said lot

is at the north of the tract, called Pond Meadow, bounded S.E. by Morse's Meadow.] The Will of Elizabeth Upham, dated Jan. 16, 1753, mentions sons Thomas and Henry Spring, dr. Mary Parmenter; dr. Elizabeth Upham, grandsons Abraham and Isaac Bigelow. Wid. Margaret Spring [61], ex'x.

[16.] Strike out all after 1711.

[20.] Ebenezer, o. c., in Wat., Ap. 12, 1741, was an early settler of New Ipswich.

- p. 149. **BUSBY**.—In Oct., 1637, Nicholas Busby was admitted an inhabitant of Newbury [Coffin, 24]. He could have remained there only a short time, as he was a selectman of Wat., in 1640. Oct. 4, 1653, John White, and wife Frances, of Boston, sold to John Coolidge, 7 acres of land in Wat., [bounded N. and W. by pastor Sherman; E. by Garritt Church; S. by highway]; "originally granted to Nicholas Busby," by him sold to John Stebbin, and by him sold to John White. The Will of Nicholas Busby, of Boston, dated July 25, proved Sept. 10, 1657, makes his wife (not named) sole exec'x.; mentions eldest son John (in England), and son Abraham; eldest daughters Anne Nickerson (wife of Wm.), Katherine Savory, youngest daughter Sarah Grout; Joseph Busby, son of his son Nicholas, deceased; and Sarah Grout, his grandchild. It mentions money and plate, which he gave to his wife; books in "Phisicke," "Divinitie" and "History," bequeathed to his two sons, and three Bibles to his three daughters. As his drs. Anne and Katherine did not embark with him, it is probable that they were married in England. It is also probable, that his dr. Sarah, m. (1st), Ens. Thomas Cakebread, and afterwards Capt. John Grout. [See General Reg. viii. p. 278.] Oct. 14, 1643, the Gen. Court granted him a bounty of 34s., for making cloth.

BUSH.—John Bush, took the oath of fidelity [not adm. freeman], 1652. In 1650, the court ordered John Bush to pay Samuel Benjamin, 10 bushels of Indian corn. Oct., 1657, John Bush was discharged of his bond, as an accomplice of John Knapp. John Bush, d. in Camb. 1, 11 mo., 1662. Mar. 3, 1683-4, Mr. Goddard to be informed that selectmen did not approve of his taking in "ould goodm. Bush's wife's sister," into his family.

BUTTERY.—Jan. 3, 1658-9, selectmen refused to admit John Buttery as a sojourner or inhabitant. He was probably the man who m. Elizabeth Knapp. [11.]

...iel Byles, of Wat., and Sarah Doubleday, m. in Boston, Jan. 21, 1762.

Thomas Cakebread, was proprietor of Wat. in 1642, to Dedham, and at this date was a resident of Sudbury. members (1637) of the Ancient and Hon. Art. Co., and m. of Capt. B. Pendleton, to Wat., the General Court ap- to lead the company of Sudbury as ensign." His name ded with that of Capt. Thomas Bredcake, a mariner, who ist the Turks, in 1644; after the decease of Ensign in Sud., Jan 4, 1643-4. He m., subsequently to Ap., Busby. His wid. Sarah, m. Capt. John Grout. [See] It has not been ascertained that he left any children. ead, of Springfield, in 1678; and one of that name in p. 468.]

CALLOW.—The land ...ver Callow, was one of the boundaries of 25 acres, sold by John Clough to William Shattuck, July 4, 1654. In Aug. 1654, John Callow sold to Abraham Williams, a dwelling-house and 12 acres of land in Newton.

- p. 150. **CAPEN**.—Josiah Capen, was selectman of Wat. 1773, 74, 75, 76, 83 and 85; was a justice of peace, as early as 1775, and major 1783.

1 **CADY**.—(I.) NICHOLAS CADY, of Wat., as early as 1645, m. JUDITH, dr. of William Knapp, Sen., of Wat. [Knapp, 5.] About 1668, he moved to Groton. They were both living there in 1680. Mar. 6, 1650-1, Nicholas Cady sold to John Knapp, of Wat., his right and title to a house and land, granted to them

- Jonathan Hubbard and Rebecca Brown, both of Concord, m. in Wat., Sept. 26, 1704.
 Samuel Brown and Hepzibah Brown m. in Wat., Dec. 17, 1728, and had dr. Hepzibah, b. Sept. 30, 1729.
- William Brown, of Newton. and Ann Molton, of Wat., m. May 8, 1746. Abijah Brown, son of William, bap. in Wat., Feb. 27, 1756, and Susanna, bap. Jan. 6. 1760.
- Samuel Brown (? son of Robert, of Newton) m. in Wat., Oct. 14, 1765, Lois Coolidge, and both o. c., July 27, 1766. [Was it his wid. or sister, Lois Brown, of Newton, who m. in Waltham, June 21, 1780, Timothy Baker, of Needham]
1. Jacob, bap. Oct. 17, 1766. 2. Amasa, bap. June 12, 1768. 3. Elizabeth, bap. July 22, 1770. 4. Anna, bap. Oct. 11, 1772.
- George Brown, son of George and Eunice, bap. in Waltham, Sept. 21, 1766. Sally Brown, dr. of George, bap. in Wat., Aug. 20, 1780. George, son of George, bap. July 21, 1782. Charles, son of George, bap. Feb. 6, 1785.
- Jonathan Locke, of Tyringham, and Abigail Brown, of Waltham, m. in W., Aug. 1, 1776.
- Lieut. John Powell and Polly Brown m. in Weston, May 27, 1779.
- John and Lydia Brown had Lydia, Joseph, and Mary, bap. in Weston, Nov. 7, 1714, and Obadiah, bap. Sept. 7, 1718.
- Edward Richardson, of Jay, Me., and Sally Brown, m. in Wat., Sept. 6, 1801.
- Moses Stone and Betsey Brown, m. in Wat., Sept. 8, 1802.
- Enoch Brown and Jemima Mills, m. in Waltham, Oct. 13, 1803.
- Nathan Brown, of Lincoln (lineage not ascertained), m. (1st) Mary, dr. of George and Mary (Barrett) Farrar. She d. Sept. 29, 1759, and he m. (2d) May 22, 1760, Mary, wid. of Isaac Brown [109] of Waltham, where he resided some time, and was assessor in 1761. He returned to Lincoln, and d. there, Oct. 13, 1781. [See Geneal. Reg. I., p. 256.]

p. 147. **BUCKS.** For Bucks, read Rucks. See Rucks, in Part II.

BULL.—In first line, for 1656, read 1652. William Bull, of Wat., was a son of William Bull, of Cambridge. In a suit, in 1683, he is called "William Bull, Jr."

BULLARD.—June 17, 1679. Testimony of Mary Bullard (wife of William Bullard, of Charlestown [father of Nathaniel], formerly wife of Francis Grissell [Grisswold], of Charlestown, whose Inventory was dated Nov. 9, 1652), "That before I was married, I told my husband (Wm. B.) I had two children, and an estate by him" (F. G.) Wm. Bullard and wife Mary had belonged to Camb. Church.

[2.] It is supposed that Benjamin Bullard was a brother of Robert and George, as well as of Maudlin and Anne. When he (B. B.) demanded of the selectmen the estate of his father-in-law, Thorpe, the selectmen say, Mar. 29, 1672, "we find the land of Thorpe, at his decease, was Bullard's, and his two sisters' [? Maudlin and Anna], but the use of the estate was Goodman Whittacar's till Nov. 12, 1672."

[3.] George Bullard m. (1st) Beatrice Hall, of Boston. "Beatrice Hall, now wife of George Bulward, of Watertown," was dismissed from the First Church of Boston, Nov. 17, 1644. Ap. 4, 1644, George Bulward, of Wat., sold to Thomas Straight, his homestead, a house and 8 acres, bounded west by John Knolls; E. by Esther Pickeram; S. by highway; N. by Maudlin and Anna Bullard. This was the homestead of G. B. in the list of possessions, 1642-4. At a meeting of the selectmen, Dec. 23, 1684, it was ordered that John Ball, son-in-law, and Jonathan Bullard, a son, be notified of the necessity of help for father Bullard and his wife.

p. 148. [4.] JACOB BULLARD, was in Wat. in 1680, when John Bigelow brought a suit against him; and in 1683, when John Nevinson brought a suit against him for slander. At a meeting of the selectmen, Jan. 30, 1709-10, ordered that the selectmen address the Judges of the Supreme Court, concerning Jacob Bullard, an aged blind person, who is unhappily sent from another province. He was buried Nov. 21, 1715.

[4.] Strike out (?), also (supposed his dr.).

[11.] Strike out (?). Abigail, 3d child of Joseph and Elizabeth Bullard, m. Abraham Bigelow, of Weston. [Bigelow, 140.] [Mar. 5, 1706-7, Joseph Bullard, of Wat., miller, sold to Francis Fulham, 1 acre in Eddy's Farm, south side Sudbury road, late of Alexander Miller, of Piscataqua: bounded W. by F. Fulham; N. by Samuel Jones, and Jonathan Bullard, Sen.; E. by J. B.; S. by Land of Contention; the said lot

is at the north of the tract, called Pond Meadow, bounded S.E. by Morse's Meadow.] The Will of Elizabeth Upham, dated Jan. 16, 1753, mentions sons Thomas and Henry Spring, dr. Mary Parmenter; dr. Elizabeth Upham, grandsons Abraham and Isaac Bigelow. Wid. Margaret Spring [61], ex'x.

[16.] Strike out all after 1711.

[20.] Ebenezer, o. c., in Wat., Ap. 12, 1741, was an early settler of New Ipswich.

p. 149. **BUSBY**.—In Oct., 1637, Nicholas Busby was admitted an inhabitant of Newbury [Coffin, 24]. He could have remained there only a short time, as he was a selectman of Wat., in 1640. Oct. 4, 1653, John White, and wife Frances, of Boston, sold to John Coolidge, 7 acres of land in Wat., [bounded N. and W. by pastor Sherman; E. by Garritt Church; S. by highway]; "originally granted to Nicholas Busby," by him sold to John Stebbin, and by him sold to John White. The Will of Nicholas Busby, of Boston, dated July 25, proved Sept. 10, 1657, makes his wife (not named) sole exec'x.; mentions eldest son John (in England), and son Abraham; eldest daughters Anne Nickerson (wife of Wm.), Katherine Savory, youngest daughter Sarah Grout; Joseph Busby, son of his son Nicholas, deceased; and Sarah Grout, his grandchild. It mentions money and plate, which he gave to his wife; books in "Phisicke," "Divinitie" and "History," bequeathed to his two sons, and three Bibles to his three daughters. As his drs. Anne and Katherine did not embark with him, it is probable that they were married in England. It is also probable, that his dr. Sarah, m. (1st), Ens. Thomas Cakebread, and afterwards Capt. John Grout. [See General Reg. viii. p. 278.] Oct. 14, 1643, the Gen. Court granted him a bounty of 34s., for making cloth.

BUSH.—John Bush, took the oath of fidelity [not adm. freeman], 1652. In 1650, the court ordered John Bush to pay Samuel Benjamin, 10 bushels of Indian corn. Oct., 1657, John Bush was discharged of his bond, as an accomplice of John Knapp. John Bush, d. in Camb. 1, 11 mo., 1662. Mar. 3, 1683-4, Mr. Goddard to be informed that selectmen did not approve of his taking in "ould goodm. Bush's wife's sister," into his family.

BUTTERY.—Jan. 3, 1658-9, selectmen refused to admit John Buttery as a sojourner

Benjamin Bullard was son of Robert & Anne Bullard. "Father-in-law" Thorp means step-father, Robert Bullard's widow Anne having married (?) Henry Thorp.

E. E. Dana.

There was an Isaac Cakebread, of Springfield, in 1678; and one of that name in Hartford, in 1680. [Hinman, p. 468.]

CALLOW.—The land of Oliver Callow, was one of the boundaries of 25 acres, sold by John Clough to William Shattuck, July 4, 1654. In Aug. 1654, John Callow sold to Abraham Williams, a dwelling-house and 12 acres of land in Newton.

p. 150. **CAPEN**.—Josiah Capen, was selectman of Wat. 1773, 74, 75, 76, 83 and 85; was a justice of peace, as early as 1775, and major 1783.

1 **CADY**.—(I.) NICHOLAS CADY, of Wat., as early as 1645, m. JUDITH, dr. of William Knapp, Sen., of Wat. [Knapp, 5.] About 1668, he moved to Groton. They were both living there in 1680. Mar. 6, 1650-1, Nicholas Cady sold to John Knapp, of Wat., his right and title to a house and land, granted to them

- Jonathan Hubbard and Rebecca Brown, both of Concord, m. in Wat., Sept. 26, 1704.
 Samuel Brown and Hepzibah Brown m. in Wat., Dec. 17, 1728, and had dr. Hepzibah, b. Sept. 30, 1729.
 William Brown, of Newton, and Ann Molton, of Wat., m. May 8, 1746. Abijah Brown, son of William, bap. in Wat., Feb. 27, 1756, and Susanna, bap. Jan. 6, 1760.
 Samuel Brown (? son of Robert, of Newton) m. in Wat., Oct. 14, 1765, Lois Coolidge, and both o. c., July 27, 1766. [Was it his wid. or sister, Lois Brown, of Newton, who m. in Waltham, June 21, 1780, Timothy Baker, of Needham]
 1. Jacob, bap. Oct. 17, 1766. 2. Amasa, bap. June 12, 1768. 3. Elizabeth, bap. July 22, 1770. 4. Anna, bap. Oct. 11, 1772.
 George Brown, son of George and Eunice, bap. in Waltham, Sept. 21, 1766. Sally Brown, dr. of George, bap. in Wat., Aug. 20, 1780. George, son of George, bap. July 21, 1782. Charles, son of George, bap. Feb. 6, 1785.
 Jonathan Locke, of Tyringham, and Abigail Brown, of Waltham, m. in W., Aug. 1, 1776.
 Lieut. John Powell and Polly Brown m. in Weston, May 27, 1779.
 John and Lydia Brown had Lydia, Joseph, and Mary, bap. in Weston, Nov. 7, 1714, and Obadiah, bap. Sept. 7, 1718.
 Edward Richardson, of Jay, Me., and Sally Brown, m. in Wat., Sept. 6, 1801.
 Moses Stone and Betsey Brown, m. in Wat., Sept. 8, 1802.
 Enoch Brown and Jemima Mills, m. in Waltham, Oct. 13, 1803.
 Nathan Brown, of Lincoln (lineage not ascertained), m. (1st) Mary, dr. of George and Mary (Barrett) Farrar. She d. Sept. 29, 1759, and he m. (2d) May 22, 1760, Mary, wid. of Isaac Brown [109] of Waltham, where he resided some time, and was assessor in 1761. He returned to Lincoln, and d. there, Oct. 13, 1781. [See Geneal. Reg. I., p. 256.]

p. 147. **BUCKS.** For Bucks, read Rucks. See Rucks, in Part II.

BULL.—In first line, for 1656, read 1652. William Bull, of Wat., was a son of William Bull, of Cambridge. In a suit, in 1683, he is called "William Bull, Jr."

by highway; iv. by ~~straw~~ ~~and~~ ~~the~~ ~~selectmen~~ ~~of~~ ~~the~~ ~~town~~ ~~of~~ ~~Weston~~ ~~in~~ ~~the~~ ~~list~~ ~~of~~ ~~possessions~~, 1642-4. At a meeting of the selectmen, Dec. 23, 1684, it was ordered that John Ball, son-in-law, and Jonathan Bullard, a son, be notified of the necessity of help for father Bullard and his wife.

- p. 148. [4.] JACOB BULLARD, was in Wat. in 1680, when John Bigelow brought a suit against him; and in 1683, when John Nevinson brought a suit against him for slander. At a meeting of the selectmen, Jan. 30, 1709-10, ordered that the selectmen address the Judges of the Supreme Court, concerning Jacob Bullard, an aged blind person, who is unhappily sent from another province. He was buried Nov. 21, 1715.
 [4.] Strike out (?), also (supposed his dr.).
 [11.] Strike out (?). Abigail, 3d child of Joseph and Elizabeth Bullard, m. Abraham Bigelow, of Weston. [Bigelow, 140.] [Mar. 5, 1706-7, Joseph Bullard, of Wat., miller, sold to Francis Fulham, 1 acre in Eddy's Farm, south side Sudbury road, late of Alexander Miller, of Piscataqua: bounded W. by F. Fulham; N. by Samuel Jones, and Jonathan Bullard, Sen.; E. by J. B.; S. by Land of Contention; the said lot

is at the north of the tract, called Pond Meadow, bounded S.E. by Morse's Meadow.] The Will of Elizabeth Upham, dated Jan. 16, 1753, mentions sons Thomas and Henry Spring, dr. Mary Parmenter; dr. Elizabeth Upham, grandsons Abraham and Isaac Bigelow. Wid. Margaret Spring [61], ex'x.

[16.] Strike out all after 1711.

[20.] Ebenezer, o. c., in Wat., Ap. 12, 1741, was an early settler of New Ipswich.

p. 149. **BUSBY**.—In Oct., 1637, Nicholas Busby was admitted an inhabitant of Newbury [Coffin, 24]. He could have remained there only a short time, as he was a selectman of Wat., in 1640. Oct. 4, 1653, John White, and wife Frances, of Boston, sold to John Coolidge, 7 acres of land in Wat., [bounded N. and W. by pastor Sherman; E. by Garritt Church; S. by highway]; "originally granted to Nicholas Busby," by him sold to John Stebbin, and by him sold to John White. The Will of Nicholas Busby, of Boston, dated July 25, proved Sept. 10, 1657, makes his wife (not named) sole exec'x.; mentions eldest son John (in England), and son Abraham; eldest daughters Anne Nickerson (wife of Wm.), Katherine Savory, youngest daughter Sarah Grout; Joseph Busby, son of his son Nicholas, deceased; and Sarah Grout, his grandchild. It mentions money and plate, which he gave to his wife; books in "Phisicke," "Divinitie" and "History," bequeathed to his two sons, and three Bibles to his three daughters. As his drs. Anne and Katherine did not embark with him, it is probable that they were married in England. It is also probable, that his dr. Sarah, m. (1st), Ens. Thomas Cakebread, and afterwards Capt. John Grout. [See Geneal. Reg. viii. p. 278.] Oct. 14, 1643, the Gen. Court granted him a bounty of 34s., for making cloth.

BUSH.—John Bush, took the oath of fidelity [not adm. freeman], 1652. In 1650, the court ordered John Bush to pay Samuel Benjamin, 10 bushels of Indian corn. Oct., 1657, John Bush was discharged of his bond, as an accomplice of John Knapp. John Bush, d. in Camb. 1, 11 mo., 1662. Mar. 3, 1683-4, Mr. Goddard to be informed that selectmen did not approve of his taking in "ould goodm. Bush's wife's sister," into his family.

BUTTERY.—Jan. 3, 1658-9, selectmen refused to admit John Buttery as a sojourner or inhabitant. He was probably the man who m. Elizabeth Knapp. [11.]

BYLES.—Daniel Byles, of Wat., and Sarah Doubleday, m. in Boston, Jan. 21, 1762.

CAKEBREAD.—Ensign Thomas Cakebread, was proprietor of Wat. in 1642, although he had first gone to Dedham, and at this date was a resident of Sudbury. He was one of the original members (1637) of the Ancient and Hon. Art. Co., and in Sept., 1642, after the return of Capt. B. Pendleton, to Wat., the General Court appointed Ensign Cakebread, "to lead the company of Sudbury as ensign." His name has sometimes been confounded with that of Capt. Thomas Bredecake, a mariner, who obtained a commesseion against the Turks, in 1644; after the decease of Ensign Thomas Cakebread, who d. in Sud., Jan 4, 1643-4. He m., subsequently to Ap., 1637, Sarah, dr. of Nicholas Busby. His wid. Sarah, m. Capt. John Grout. [See Busby, also Grout, in Part II.] It has not been ascertained that he left any children. There was an Isaac Cakebread, of Springfield, in 1678; and one of that name in Hartford, in 1680. [Hinman, p. 468.]

CALLOW.—The land of Oliver Callow, was one of the boundaries of 25 acres, sold by John Clough to William Shattuck, July 4, 1654. In Aug. 1654, John Callow sold to Abraham Williams, a dwelling-house and 12 acres of land in Newton.

p. 150. **CAPEN**.—Josiah Capen, was selectman of Wat. 1773, 74, 75, 76, 83 and 85; was a justice of peace, as early as 1775, and major 1783.

1 **CADY**.—(I.) NICHOLAS CADY, of Wat., as early as 1645, m. JUDITH, dr. of William Knapp, Sen., of Wat. [Knapp, 5.] About 1668, he moved to Groton. They were both living there in 1680. Mar. 6, 1650-1, Nicholas Cady sold to John Knapp, of Wat., his right and title to a house and land, granted to them

jointly, by deed, dated Dec. 8, 1645. This shows that he was in Wat., as early as 1645. Sept. 11, 1668, "John" [Nicholas] Cady, of Groton, and wife Judith, sold to George Lawrence, 6 A. of upland, and 5 A. of meadow, in Wat. Ap. 29, 1680, Nicholas Cady, planter, of Groton, and wife Judith, sold to Simon Coolidge, of Wat. 25 A. dividend land, also 6 A. near West Meadow. Chil.,

- 2 1. JOHN, b. Jan. 15, 1650-1; m. (1st), JOANNA ——. He m. (2d) ELIZABETH ——. About 1701, he moved to Canterbury, Conn.
- 3 1. *Jonathan*, b. in Groton, Jan. 22, 1693, of Canterbury, by wife *Hannah*, had several chil.
- 4 2. *Joanna*, b. in G., Oct. 14, 1695.
(By 2d wife.)
- 5 3. *John*, b. in G., Aug. 7, 1699 (?), of Tolland, m. in Wat., May 6, 1729, *Hannah Abbot*. [See Abbot, in Part II.]
- 6 4. *Elizabeth*, b. in G., Mar. 5, 1701.
- 7 5. *William*, b. in Canterbury, 1704.
- 8 6. *Eleazer*, b. in C., 1708. 7. *Ebenezer*, b. in C., 1714.
- 10 2. JUDITH, b. Sept. 2, 1653.
- 11 3. JAMES, b. Aug. 28, 1655; d. Dec. 2, 1690; m. in Wat., June 14, 1678, HANNAH BARRON [4].
- 12 1. *Elizabeth*, b. in Groton, Ap. 10, 1686.
- 13 4. NICHOLAS, b. Aug. 2, 1657; d. next Jan. 21.
- 13 5. DANIEL, b. Nov. 27, 1659. [This is probably the David, mentioned by Hinman, p. 467, who was the owner of a large tract of land, now within the limits of Brooklyn, Conn.; who purchased land in Canterbury, Conn., in 1714, and d. there in 1736, where his wife Mary, also died.] He m. 1st, MARY ——. He m. (2d), ABIGAIL ——. Chil. b. in Groton:
- 14 1. *Mary*, b. Aug. 10, 1684. 2. *Ezekiel*, b. Sept. 29, 1686.
- 16 3. *Rachel*, b. July 18, 1689.
- 17 4. *Daniel*, b. Mar. 26, 1692 (?), of Canterbury; m., in 1712, *Joanna Leach*.
- 18 5. *Jane*, b. Ap. 1, 1696.
- 19 6. *Ezra*, b. Aug. 11, 1699 (?); m. *Hannah Winter*.
- 20 7. *Josiah*, b. Feb. 7, 1702. 8. *Eunice*, b. Oct. 20, 1704 (? 3).
(By 2d wife.)
- 22 9. *Ephraim*, b. Feb. 19, 1704-5.
- 23 6. EZEKIEL, b. June 14, 1662.
- 24 7. NICHOLAS, b. Feb. 20, 1663-4, (?) of Wethersfield, Conn.
- 25 8. JOSEPH, b. May 28, 166-, of Groton; m. SARAH ——. In 1714, after the birth of his fifth child, he purchased land in Canterbury.
- 26 1. *Joseph*, b. in G., Oct. 3, 1690. 2. *James*, b. Nov. 22, 1694.
- 28 3. *Isaac*, b. Jan. 17, 1696-7. 4. *Abigail*, b. June 22, 1699.
- 30 5. *Stephen*, b. June 16, 1701.
- 31 9. AARON, supposed to be a son, birth not recorded; m. MERCY FULLER, dr. of Joshua [20; in Part II.].
- 32 1. *James*, b. in Wat. Nov. 15, 1692. James Cady belonged to Isaac How's garrison, in Marlboro, in Dec. 1711.
- 33 2. *Aaron*, b. in Canterbury, Conn., 1718.

p. 150. **CARTER**.—Rev. Thomas Carter, first of Wat., afterwards of Woburn, is said to be the ancestor of the families of that name in Lancaster. [Worcester Mag. II., p. 295.] Thomas Carter, of Reading, m., in 1711, ABIGAIL LOCKE, and had son *Thomas*, b. 1713. Did he move to Weston?

CARVER.—On the court files for 1661, is a copy of a grant of land in Watertown, in 1638, to Richard Carver, signed by Ephraim Child. The homestall of Wm. Jennison, was bounded E. partly by Richard "Carter" (? Carver).

CAVERLY.—Anthony Caverly, was selectman of Wat. 1733 and 34.

CHADWICK.—[See Fox, Part II.] Feb. 27, 1689-90, inquest on the body of Samuel Chadwick, of Reading, killed by the fall of a tree. Was he a son of John, of Malden?

- [4.] Will of John Chadwick, dated Jan. 31, proved Mar. 15, 1710–11, mentions wife Sarah, sons Charles, John, Ebenezer, Joseph, and Benjamin; dr. Hannah Hayward, dr. Elizabeth Woolson, Sarah and Mary, 2 youngest daughters. Inventory, house and 7 A. £60; 7 A. marsh, £50; 4 A. waste land, £12; 26 A. of pasture land.
- [7.] Besides Charles, Elizabeth, and Abigail, Charles Chadwick, of Wat. Farms, had dr. Submit, and probably others. Sept. 9, 1706, for £15, at 8s. per ounce, he mortgaged to his brother, "Ebenezer Chadwick, of Boston, waterman," 35 acres, near John Sawin; condition, to pay Joanna Everton, of Charlestown. Mortgage not discharged. June 9, 1709, he and wife Sarah, sold to Edward Harrington, 1½ A. of meadow, and 4 A. of meadow; July 9, 1711, he sold to Ebenezer Chadwick, 18 A. in Wat. [Weston.] About 1709, he became indigent, and he and his family became unsettled, changing their residence several times.
- [7–1.] In Court C. C. P., suit in 1723 v. Charles Chadwick, Jr., formerly of Weston, now of Killingley.
- [8.] John Pillsbury, moved from Lex. to Wat., in Mar., 1722. Suit in court, 1726, John Pillsbury, now of Wat., laborer, v. Elizabeth Parks, ex'x of her husband Richard, of Concord, for 10 months' service in 1707, at 40s. per month.
- [9.] John, Jr., had a dr. Lydia, who m. Thomas Adams, of Worcester. [See Locke Family, p. 48.]
- [10.] In 1706, Ebenezer Chadwick, was a "waterman," of Boston. He d. before Mar. 31, 1727. Ap. 6, 1710, he (of Wat. Farms) sold to David Stone, and Edward Goddard, of Boston, 3 lots in Wat., amounting to 30 acres.
- [11.] For 1716, read 1710.
- [12.] Benjamin Chadwick, m. in Camb., May 10, 1711, Hannah Welch.

p. 152. **CHAMBERLIN.**—[See Thomas Hammond, 7, in Part II.] Ephraim Chamberlin, of Newton, m., in Wat., Oct. 21, 1723, Mary Sawin [9]. Abraham Chamberlin, of Rox., m. in Wat. Oct. 26, 1716, Mary Whitney. In Feb. 1766, Sarah Chamberlin moved from Needham to Watertown.

CHAPLIN.—July 29, 1699, Francis Chaplin, of Wat., clothier, conveys to Robert Calf, of Boston, sundry utensils.

CHAPMAN.—Nov. 1725, John Chapman came from Rhode Island to Wat., and was warned out.

CHEENEY.—"The aged wid. Cheeney" d. in Wat., Jan. 28, 1746, aged 82.

CHESTER.—(1.) LEONARD CHESTER, from Brady (or Blaby) Leicestershire, of a very respectable lineage, came to New England in 1633, then aged about 23 or 24 years, and settled in Watertown. Two years afterwards, he left Watertown with the colony that first planted Pyquag, which they named Watertown; soon after, by the Court, named Wethersfield. He left Watertown previous to the making out of the earliest list of possessions, and his name, therefore, is not found in any list of proprietors; but it is recorded that one of the lots of Mr. William Paine was bought of Mr. Chester. Several circumstances, in confirmation of tradition, evince his respectable social position, and that he was comparatively wealthy. His name occurs only once in Massachusetts Colonial Records (in Ap. 1634), and then, although so young a man, he was designated as "Mr. Chester." Although he remained in Watertown only about two years, a considerable water-course (the outlet of Sherman's Pond, sometimes, of late, called the West Branch of Beaver Brook) was named for him, Chester Brook. A tract of land was also named Chester Meadow, and these names were long retained. In laying out the Naubuc Farms, on the east side of Connecticut River [now in Glastenbury] previous to 1640, which was "the first tract of land in the Colony regularly surveyed and laid out into farms," Mr. Chester's allotment was the largest except four, viz.: 1. To Elder Clement Chaplin 1200 acres; 2. To Matthew Mitchell (? father of Rev. Jonathan Mitchell, of Cambridge) 900 A.; 3. To Governor George Wyllis, 480 A.; 4. To Gov. Thomas Welles, 435 A.; 5. To Mr. Leonard Chester, 432 A. The next largest was to Mr. Thurston Raynor, 330 A.

PEDIGREE OF CHESTER, OF BLABY.

From *Nichols's History of Leicestershire.*

Arms: ermine on a chief sable, a griffin passant, Argent.

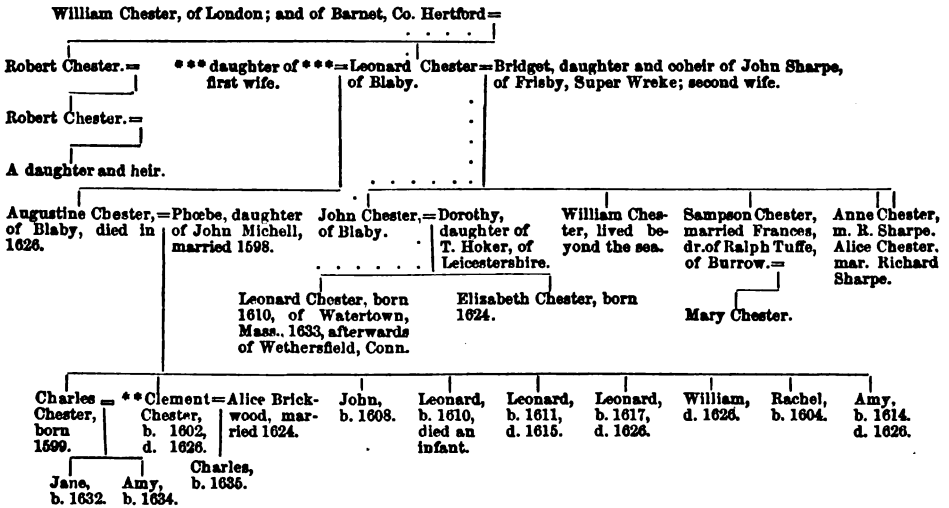

His eldest son John, by wife, MARY (NEVILL), was born in Watertown, where she was left, on account of her health, until he could go and prepare accommodations for her. We have not found this birth upon the town records of births, which did not begin to be kept until after Mr. Chester's removal. He was a juror in 1643, 44, and 45, and a grand juror in 1643-44. He d. Dec. 11, 1648, aged 38 or 39, and his wid. Mary, married Hon. Richard Russell,* of Charlestown, s. p. She was probably the Mary Russell admitted to Charlestown Church, Feb. 21, 1655-6. She d. in Charlestown, Nov. 30. (Will dated Nov. 20), 1688. Chil.,

9. 2 | 1. JOHN, b. in Watertown, Mass., Aug. 3, 1635; a captain, of Wethersfield.
24. 3 | 2. DORCAS, b. in Wethersfield, Nov. 1, 1637; m. Rev. SAMUEL WHITING.
- 4 | 3. STEPHEN, b. Mar. 3, 1639, d. Ap. 23, 1705, unm.; his brother, Captain John, administrator. Inventory, £200 15s. 6d.; his estate distributed to his brother John, to his brother-in-law, Rev. Samuel Whiting, and to the two children of Thomas Russell, of Charlestown, d., who had m. his sister Prudence, viz.: Thomas, Jr., and Prudence.
- 5- | 4. MARY, b. Jan. 15, 1641; d. in Charlestown, Sept. 15, 1669, unm.
- 6 | 5. PRUDENCE, b. Feb. 16, 1643; m. in Charlestown, Dec. 30, 1669, Capt. THOMAS RUSSELL, Esq., of Charlestown. He d. Oct. 20, 1676 [monument]. She d. Oct. 21, and her Inventory proved Dec. 5. 1678. Chil.,
 1. Mary, b. Sept. 27, 1670, m. John Watkins. Mary, wife of John Watkins, appeared Aug. 1, 1693, as one of the heirs of Thomas and Prudence Russell. She probably d. early, s. p. [See Chester, 4].

* The Will of Richard Russell, Esq., of Charlestown, dated Mar. 29, 1674, proved May 18, 1674, mentions wife Mary, her eldest daughter, the wife of Samuel Whiting, and her 7 children, her second daughter [then living], wife of Thomas Russell, and her two children [before the birth of the third], her third daughter, Eunice Chester, and her son, Stephen Chester. His eldest son, James Russell, and his wife and three children; his daughter Katherine, wife of William Roswell, and her son William; his daughter Elizabeth, wife of N. Graves; his sister, Mrs. Elizabeth Corbett; sister Sarah Russell, widow, of Bristol, England; sister Mary Newall, wid., and her sons, John and Joseph; Mary Golden and Eleazer Allen. [See Saltonstall, 51, in Part II.]

The Will of Mary Russell, dated Nov. 20, 1689, proved Oct. 1, 1689, mentions eldest son, Capt. John Chester, of Wethersfield, dr. Dorcas, and granddr. Elizabeth Whiting; her second son, Stephen Chester; the orphans of daughter Prudence, viz.: Thomas, Mary, and Prudence (to whom she bequeathed land bought of Daniel Russell, her stepson); sons-in-law James Russell and Richard Sprague.

2. *Thomas*, b. Mar. 30, 1672; living in 1705.
 3. *Prudence*, bap. Mar. 28, 1675; living in 1705.
- 7 6. *EUNICE*, b. June 15, 1645; m., Feb. 25, 1673, Capt RICHARD SPRAGUE, of Charlestown, son of Ralph Sprague. She d. May 27, 1676, probably s. p.
- 8 7. *MERCY*, b. Feb. 14, 1647; d. in Charlestown, Mass., in 1669. Her Will, dated Aug. 5 (Inventory, Dec. 18), 1669, mentions brother John and her three sisters, Dorcas Whiting, and Prudence and Eunice Chester.
-
2. 9 (II.) Capt. JOHN CHESTER, of Wethersfield, m., in Feb. 1653-4, SARAH WELLES, dr. of Hon. Thomas Welles, of Wethersfield, successively Treasurer, Secretary, Lt. Governor, and Governor of Connecticut. He was adm. freeman in May, 1658, was a member of the first troop in Connecticut, and a deputy in May, 1676, and several times afterwards. He was very useful and influential in the colony. He d. Feb. 23, 1697-8, and his wid. Sarah d. Dec. 12, 1698. His Will, dated Feb. 21, 1697-8, and proved May 6, 1698. Inventory, £1103.
- 10 1. *MARY*, b. Dec. 23, 1654; m., Feb. 14, 1676-7, JOHN WOLCOTT. She d. July 10, 1689.
31. 11 2. *JOHN*, b. June 10, 1656; a major, of Wethersfield.
- 12 3. *SARAH*, b. Nov. 11, 1657; m., Dec. 5, 1689, SIMON WOLCOTT, of Windsor.
- 13 4. *STEPHEN*, b. May 26, 1659; of Wethersfield; m., Dec. 17, 1691, JEMIMA TREAT, b. 1668, dr. of James and Rebecca Treat, of Wethersfield. He d. Feb. 9, 1697-8. Inventory, £1140; distributed Ap. 5, 1714: to wid. Jemima, £210 11s. 10d.; to son Stephen John, £500 11s. 2d.; to his drs. Dorothy, Sarah, and Mercy, each £250 5s. 7d. Chil.,
- 14 1. *Dorothy*, b. Sept. 5, 1692; m. *Martin Kellogg*.
- 15 2. *Sarah*, b. 1693-4; m. — *Lamb*.
- 16 3. *Mercy*, b. Oct. 26, 1696; of Wethersfield; d. unm. and her estate was distributed Feb. 6, 1749, to her two sisters, viz., to Dorothy, wife of Martin Kellogg, £794 8s. 10½d, and the same sum to wid. Sarah Lamb.
- 17 4. *Stephen John*, b. Feb. 1697-8; grad. Yale Coll. 1724; d. 1725.
- 18 5. *THOMAS*, b. Mar. 23, 1661-2, of Wethersfield; m., Dec. 10, 1684, *MARY TREAT*, b. 1666, dr. of Richard and Sarah Treat, of Wethersfield (Glastenbury). He d. Dec. 5, 1712, aged 50, and his wid. d. in 1748, aged 81. To his widow he bequeathed movables and £152 0s. 7d., and to each of his two drs., £746 11s. 6d. Chil.,
- 19 1. *Eunice*, b. Nov. 22, 1685; m., about 1717, *Elisha Williams*, b. Aug. 26, 1694, son of Rev. William Williams, of Deerfield; grad. Harv. Coll. 1711, ordained at Newington, in Wethersfield, Oct. 22, 1722. He afterwards studied law, engaged in civil and military life, and attained to the rank of Colonel and Judge. In 1726, he was elected Rector of Yale College, and held the office 13 years. His wife Eunice d. May 3, 1750. He m. a second wife in England, returned, and d. July 25, 1755. [See Williams Family, pp. 190-94.]
- 20 2. *Samuel*, b. Sept. 29, 1696; d. Dec. 14, 1700.
- 21 3. *John*, b. Dec. 17, 1699; d. Dec. 14, 1700.
- 22 4. *Mary*, b. Jan. 6, 1706.
- 21 6. *SAMUEL*, b. May 23, 1664, d. 1689.
- 22 7. *PRUDENCE*, b. Dec. 10, 1666.
- 23 8. *EUNICE*, b. May 17, 1668; m. *TIMOTHY STEVENS*. (? Rev. T. Stevens, grad. Harv. Coll. 1687, d. 1725.) She d. June 16, 1698.
-
3. 24 (II.) Rev. SAMUEL WHITING, Jr., b. in England in 1633, son of Rev. Samuel Whiting, of Lynn, by his 2d wife, Elizabeth, dr. of the Right Hon. Oliver St. John, of England. [Farmer]. He grad. Harv. Coll. 1653, settled in Billerica, in 1658, and ordained there, Nov. 11, 1663. He m., in Salem, Nov. 12, 1656, *DORCAS CHESTER*, of Wethersfield. She d. Feb. 15, and he d. Feb. 28, 1713. Chil.,
- 25 1. *ELIZABETH*, b. 1660, adm. f. c. Charlestown, June 29, 1683; m., in 1702, Rev. THOMAS CLARK (his 2d wife), b. Mar. 2, 1653, son of Elder Jonas Clark, of Cambridge, by his 2d wife Elizabeth. He grad. Harv. Coll. 1670, was the second minister of Chelmsford, and the successor of Rev. John Fiske. He d. 1704. She d. s. p.

- 26 2. SAMUEL, b. Jan. 19, 1662; a Dea. of Billerica; d. Mar. 14, 1715, leaving issue.
- 27 3. JOHN, b. Aug. 1, 1664, grad. Harv. Coll., 1685; ordained at Lancaster, Dec. 3, 1691; was shot and scalped by Indians, Sept. 11, 1697, and left wid. ALICE. He refused quarter, and fought till overpowered.
- 28 4. OLIVER, b. Nov. 8, 1665; a magistrate, of Billerica, many years; m., Jan. 22, 1690, ANNA, dr. of Capt. Jonathan and Elizabeth (Poulter) Danforth, of Billerica. 9 chil.,
- 29 5. DOROTHY.
- 30 6. JOSEPH, b. Feb. 7, 1669 (?); grad. Harv. Coll. 1690; d. Sept. 6, 1701.
7. JAMES. 8. EUNICE. 9. BENJAMIN. 10. BENJAMIN, all four d. young.
-
11. 31 (III.) Major JOHN CHESTER, of Wethersfield, m., Nov. 25, 1686, HANNAH TALCOTT, b. in 1665, dr. of Capt. Samuel and Hannah (Holyoke) Talcott, of Wethersfield (Glastenbury), and gr. dr. of John and Dorothy (Smith) Talcott, of Wethersfield. He d. Dec. 14, 1711, and his wid. Hannah, d. July 23, 1741, æt. 71. Chil.,
-
- 38 1. PENELOPE, b. Oct. 21, 1687; d. soon. 2. MEHITABEL, b. Jan. 29, 1688-9.
- 39 3. MARY, b. Mar. 8, 1691. 4. PENELOPE, b. Nov. 18, 1695.
- 41 5. HANNAH, b. May 15, 1696; d. May 29, 1749.
- 42 6. PRUDENCE, b. Mar. 4, 1699; m., Dec. 13, 1731 (? 13), Col. JOHN STODDARD, Esq., of Northampton, b. Feb. 17, 1682, youngest son of Rev. Solomon and Esther (Warham) Stoddard, of Northampton, grad. Harv. Coll. 1701. He d. in Boston, June 19, 1748, and his wid. d. Sept. 11, 1780, æt. 81. [For his genealogy, and the journal of his mission, with the Rev. John Williams ("the redeemed captive"), to the French authorities in Canada, in the years 1713 and 14, see General. Reg. V., pp. 21-42.] Chil.,
- 43 1. Mary, b. Nov. 27, 1732; d. July 12, 1812; m. Col. John Worthington, of Springfield, grad. Harv. Coll. 1740; High Sheriff, of Hampshire County. She was his 2d wife.
- 44 2. Prudence, b. May 28, 1734; m., Nov. 6, 1760, Ezekiel Williams, Esq., of Wethersfield, High Sheriff of Hartford County.
- 45 3. Solomon, b. May 29, 1736, grad. Yale Coll. 1756; d. Dec. 19, 1827; settled in Northampton, and was High Sheriff of Hampshire County.
- 46 4. Israel, b. Ap. 28, 1741, grad. Yale Coll. 1758, settled in Berkshire, and was High Sheriff of Berkshire County. He d. 1782.
- 47 7. EUNICE, b. May 11, 1701.
50. 48 8. JOHN, b. June 30, 1703, grad. Yale Coll. 1722.
- 49 9. SARAH, b. July 1, 1707; m. Col. ISRAEL WILLIAMS, Judge, &c., of Hatfield, b. Nov. 30, 1709, youngest son of Rev. William Williams, of Hatfield (and brother of Rev. Wm. Williams, of Weston, and of Rector Elisha Williams, see 19), grad. Harv. Coll. 1729. He d. in 1789. [For her children and numerous respectable descendants, see Williams Family, p. 198, &c.] She d. in Hatfield, Sept. 18, 1770, aged 63.
10. THOMAS, b. Aug. 31, 1711; d. soon.
-
48. 50 (IV.) Col. JOHN CHESTER, Jr. Esq., of Wethersfield, grad. Harv. Coll. 1722, A.M., 1729. He m., Nov. 19, 1747, SARAH NOYES, dr. of Rev. James Noyes, of New Haven. He was often Representative in the General Assembly, and Assistant, and was "distinguished for integrity and brilliancy of talents." He was also a Judge of the County Court, "was one of the most important men in the colony;" useful in the church, "a father to the fatherless, and a God to the widow." He d. suddenly in his hay-field, Sept. 11, 1771, æt. 69, leaving widow Sarah. In 1748, he is said to have been "the only male in his line, of the name of Chester." Chil.,
-
- 51 1. JOHN, b. Jan. 18, 1749; grad. Yale Coll. 1766, A. M. and Harv. 1775. In 1775, he joined the army in the siege of Boston, at the head of a company of volunteers, signalized himself at the Battle of Bunker Hill, and for his bravery was advanced to the command of a regiment. He resigned in 1777, on account of the imperious calls of his family. From 1772 to 1788, he was often elected Representative, and for several years in succession Speaker of the House. In 1788, and repeatedly afterwards, he was elected as State Councillor; was also Judge of Probate, and of the County Court. In 1791, President Washington

- appointed him Supervisor of the District of Connecticut. He m., Nov. 25, 1773, ELIZABETH, dr. of Hon. Jabez Huntington, of Norwich. Col. Chester d. Nov. 4, 1809. His wid. d. July 1, 1839. Chil.,
- 52 1. *Elizabeth*, b. Nov. 10, 1774; m., June 8, 1807, *Elexzer F. Backus* (his 2d wife), then a bookseller of Albany, now (1855) a resident of Philadelphia, where she d. a few years ago. Chil.,
 1. John Chester. 2. Trumbull; both Presbyterian ministers.
 3. Mary, m. James Bayard, a lawyer, of Philadelphia, grad. New Jersey Coll. 1820, s. p.
- 53 2. *Mary*, b. Ap. 20, 1779; m., June 3, 1806, Capt. *Ebenezer Welles*, of Brattleboro, Vt.
- 54 3. *Hannah*, b. Oct. 27, 1781; m., Sept. 26, 1808, *Charles Chauncey, Jr. Esq.*, LL.D., b. in 1777, son of Hon. Charles Chauncey, of New Haven; grad. Yale Coll. 1792, settled in Philadelphia, and became one of the most eminent jurists and advocates of his time. He was distinguished for his courteousness and kindness; for his strict integrity, and most exemplary private life. Mrs. Chauncey d. Feb. 6, 1821, and he d. Sept. 30, 1849. Chil. 1. Charles, grad. Yale Coll. 1828, studied law, and d. 1831. 2. Elizabeth Chester, of Philadelphia, unm. 3. Susan Vaux, d. Mar. 26, 1836, unm. 4. Hannah, of Phila., unm. 5. John Chester. 6. John Chester, both d. in infancy.
- 55 4. *Sarah*, b. June 17, 1783; of Philadelphia, unm.
- 56 5. *John*, b. Aug. 17, 1785, grad. Yale Coll. 1804; D.D., Union College, in 1821, ordained in Hudson, N. Y., in 1810, where he remained until 1815, when he was installed pastor of the 2d Presbyterian Church in Albany. He m. *Rebecca*, dr. of Robert Ralston, Esq., of Philadelphia. Ill health compelled him to withdraw from pastoral labors, and he retired to Philadelphia, where he d. Jan. 12, 1829, beloved for his virtues, and admired for his talents. Chil.,
 1. Sarah Ralston, m. Rev. Samuel Beach Jones.
 2. Elizabeth Huntington, unm.
 3. Hannah Chauncey, m. Jonathan Howard Hasbrouch.
 4. Maria Dorsey, d. in infancy.
 5. Mary Wells, m. Martin Bremer Inches.
 6. Rebecca Ralston, m. Abram Suydam Mesier.
- 57 6. *Charlotte*, b. Mar. 20, 1787; d. in Phila., July 19, 1844, unm.
- 58 7. *Henry*, b. Oct. 3, 1790; d. soon.
- 58 8. *Julia*, b. Mar. 15, 1792; m., Ap. 2, 1816, *Matthew C. Ralston*, a merchant, of Philada., son of Robert Ralston, Esq.
- 59 9. *Henry*, b. Dec. 23, 1793, grad. Un. Coll. 1814; a lawyer, of Philadelphia, where he d. in 1848, unm. He was distinguished for his integrity, and for his very kind, courteous, and gentlemanly demeanor.
- 60 10. *William*, b. Nov. 20, 1796, grad. Un. Coll. 1815, D.D., Washington Coll., Penn.; ordained in the 1st Presbyterian Church, in Hudson, N. Y., in 1822; in 1832, appointed Secretary of the Presby. Board of Education, which office he still holds, and resides in Philadelphia. He m. in 1826, Frances M. White, dr. of Dr. Samuel White, a distinguished physician, of Hudson. Chil.,
 1. Elizabeth.
 2. John, grad. New Jersey Coll., 1851; M.D., Univ. of Penn. 1853.
 11. *George*, b. June 14, 1798; d. in infancy.
- 61 2. LEONARD, b. Sept., 1750; grad. Yale Coll. 1769; m., Sept. 12, 1776, SARAH WILLIAMS, b. at Deerfield, Oct. 31, 1758, dr. of Col. William Jr., and — (Wells) Williams, of Pittsfield. [See p. 654, and Williams Family, pp. 188-9.] He moved to N. York, and d. there in 1803. Chil.,
 1. *Leonard Williams Pepperill*, b. Dec. 20, 1777.
 2. *Sarah*, b. Aug. 8, 1779. 3. *Henrietta*, b. Mar. 8, 1781.
 65 4. *Sophia* (twin), b. Mar. 8, 1781. 5. *John Noyes*, b. Mar. 20, 1783.
 67 6. *Sally Williams*, b. Nov. 2, 1784. 7. *Wm. Williams*, b. July 13, 1786.
- 69 3. SARAH, b. Aug. 12, 1752; m., THOMAS COIT, of Norwich.
- 70 4. ABIGAIL, b. May 27, 1754; m. JOSEPH WEBB, a merchant, of Wethersfield, 12 chil.
- 71 5. STEPHEN, b. Oct. 28, 1761; grad. Yale Coll., 1780, of Wethersfield; sheriff of

- Hartford County, 1789; m. ELIZABETH MITCHELL, dr. of Judge Mitchell, of W. He d. 1835. Chil., 1. *Stephen Mitchell*, of N. York, grad. Yale Coll., 1813. 2. *Walter*, of Erie, Penn. 3. *John*, of Detroit, Mich. 4. *Maria*, m. — *Strong*.
- 76 6. THOMAS, b. Jan. 7, 1764; (?) grad. Yale Coll., 1780; d. 1831, many years Clerk of the Court, at Hartford; m. ESTHER M. BULL, of Hartford. One son, *Alfred*, grad. Yale Coll., 1818, a clergyman, and 4 drs.

- CHILD.**—Letters of Rev. Henry Jacie, a celebrated Puritan minister, to John Winthrop, Jr., dated Aughton, in Yorkshire, Jan. 9, 1631–2, and June 12, 1633 [Mass. Hist. Coll. 3d Ser. I., 236 and 245], render it probable that Deacon Ephraim Child and John Firmin had resided at that place, and they show that Mr. Jacie corresponded with them.
- p. 153. [2.] Richard Child was constable 1681, selectman 1688 & 89. His Will, dated Nov. 6, 1694, mentions wife, eldest son Shubael, and 4 eldest daughters. His inventory, dated Dec. 10, 1694, house and 56 acres of land, £56; 6 other lots of land. His interest in mills at Stoney Brook, £50. Total, £224 18s. 3d. He was ordered by the Court, Jan. 23, 1693–4, to pay the selectmen 2s. a week towards the relief of his son Shubael. [3 or 4?] Mar. 7, 1721–2, Shubael Child, of Weston, and wife Abigail, for £150, sold to Joseph Patterson and Jonathan Brown, of Wat., house and land in Weston, half a mile in length, and 66 rods wide.
- [11.] Joshua Child, of Waltham, m., Jan. 1720, Sarah Stearns [J. Stearns, II. 12–3]. She o. c. June 19, 1724, and adm. f. c. Feb. 11, 1728. Their children were all (7) born and bap. in the West Precinct (Waltham). Joshua Child and wife Sarah were dismissed to Worcester, Jan. 13, 1733–4. It was probably their son Thomas, who m., in Rutland, Nov. 23, 1753, Anna Bullard. [See Hist. of Rutland, p. 131.]
- [16.] The nuncupative Will of John Child, witnessed by Daniel Warren, Sen., Richard Child, and William Goddard, Oct. 14, 1676, presented to Court Dec. 29, 1676, mentions son John, son Daniel, a minor; wife (not named) and brother Richard. Does not mention his daughter.
- [18.] For Oct. 5, read Sept. 5. July, 1705, John Child, of Wat., sold to Henry Jeffs the land inherited by Hannah, his wife, dr. of William French. Dec. 14, 1747, his wid. applied to the Court to have his Will proved.
- [18–1.] Oct. 7, 1741, John Child, with wife Jane, sons John and Nathaniel, and apprentice boy, James Duker, moved from Boston to Watertown. Was he a son of John and Hannah? [John and Sarah Child had son John. bap. in the First Church of Boston, Feb. 7, 1713–14.]
- [18–2.] Jonathan Child was pub. in Weston, “both of Weston.”
- p. 154. [18–8.] This was probably the Jonas Child of Westboro, who m., in Westboro, May 20, 1742, Sybil Stratton. Chil.,
 1. Jonas, b. Feb. 28, 1743–4. 2. Isaac, b. Jan. 16, 1744–5.
 3. Silas, b. Jan. 29, 1746–7. 4. Esther, b. Feb. 8, 1748–9.
- [26.] Grace Child, dismissed from Waltham to the North Precinct of Shrewsbury, Ap. 8, 1744.
- p. 155. [58.] Edward Child m., Sept. 13, 1798, Polly Fiske [J. Fiske, 89], and settled in Weston.
- [75.] For adm. freeman, 1654, read, took oath of fidelity, 1652. His wife, Sarah, was one of the legatees of Susanna Halstead. [See Barstow, 1, Part II.]
- p. 156. [77.] Ruth, wid. of Joseph Child, m., before July, 1720, Thomas Ingersol, of Springfield.
- [Record of a case in Court C. P. Oct. 1706. Joseph Child, Carpenter, vs. Samuel Sherman, of Wat., otherwise of Boston, laborer, in behalf of his wife Ruth, while she was sole, Oct. 20, 1704, viz., Ruth White.]
- [80.] Jonathan Child was selectman of Wat., 1759, 60, 61, 62, 63, 64, 65. (?) Rev. Jonathan Child, of Needham, d. in Wat., May 5, 1774, aged 59. The ages of these two Jonathans are the same.
- [94.] Josiah Child, m., in Boston, July 22, 1766, Lucy Stearns.
- [98.] Mar. 1765, Phineas Child, with wife Lois and 4 chil., moved from Waltham to Watertown.

CHINERY.—[1.] For 1759, read 1659.

[2.] About 1654, John Chinery, of Watertown, purchased, in New London, the home-
 stead of Capt. Daniel Dennison, who had moved to Mystic. In 1657, his agent, Rev.

Richard Blynman, sold this estate to William Chapman. [Caulkin's Hist. New London, p. 87.] It will be seen, from the date of his marriage, that he could have staid at New London only a short time, if he ever resided there. Inventory of John Chinery, dated Ap. 1, 1675 [? 76]: House and 8 acres, his homestead, £50; 10 acres of pasture, formerly of Daniel Hudson, £20; 5 acres of land, formerly of George Adams [q. v.], with a right to land in New London, £15; a legacy, left by his father, £20. His widow Sarah is mentioned.

- [3.] For Dec. 7, read 17. He (John Chinery) d. Dec. 19, 1723, "aged 66 yrs. 1 day."
 [4.] For 1684, read 1685.
 p. 158. [7.] John, d. Sept. 18, 1723, aged 28.
 [8.] Ebenezer, d. July 28, 1746, insolvent.
 [11.] It is probable that Mary and Abigail were different persons. Mary, o. c. Aug. 2, 1743, and had then dr. Mary, bap. [dr. of R. K.]
 [12.] John, d. May 6, 1732.
 [14.] John Chinery m. (pub in Malden, Nov. 15), 1751, Phebe Sargent.
 [22.] Sybil Chinery d. Aug. 31, 1823, aged 78.
 [29.] Abigail, wife of D. R., d. Sept. 8, 1726.

CHURCH.—[3.] For [33] read [49].

[6.] David Church was, in 1715–16, residing in Marlboro, where he had purchased land of Isaac Woods. He was one of Ensign Howe's garrison in 1711. [Worcester Mag. II, p. 154.] He m. before June 16, 1686.

[7.] For Higham, read Hingham. Caleb Church m. (2d) in Wat., Nov. 6, 1691, Rebecca Scotto. On the Court file is the testimony of Richard Church, dated Jan. 15, 1656, then aged 47. Sept. 1, 1676, suit was brought, Samuel Appleton vs. Caleb Church, for possession of five-sixths of corn-mill in Watertown, left to his (S. A.'s) daughter, Judith, by her grandfather [Wm. Paine]. In Mar. 1689, he signed a contract to "erect a corn or grist-mill in the village of Oxford," for the French Protestants, and on Feb. 4, 1689–90, he signed a receipt, "in full, following our bargain." [Mass. Hist. Coll. 3d Ser. II p. 31.] Aug. 7, 1681, Caleb Church sold to William Adams, of Dedham, 60 acres of land in Cambridge. Oct. 1689, John Perry petitioned the Court to remove Caleb Church from keeping an ordinary, "for it is a very disorderly house, he himself is a stirrer of strife in our town, and entertaining such as himself, who frame and make lies, and spreads them abroad," &c. His (C. C.'s) own daughter, Ruth, and a kinswoman of his wife, named Hannah Cutler, &c. This was very probably a malicious prosecution, for in Dec. 1688, John Perry was bound over in £10, for "giving forth words tending to move discord, strife, and dissension among his neighbors, and for breaking the common pound of the town in August last." He (C. C.) was selectman of Wat., 1692, 98, 99, 1700, 1, 2, and 13. [For his parentage and affinities, see Mitchell's Hist. Bridgewater, pp. 363–5, and Winsor's Hist. Duxbury, p. 245.]

Nov. 16, 1724, Jonathan Broomer, of Freetown, Bristol Co., appoints his son Joshua, Att'y, to collect his (Joshua's) mother's share of the estate of her father, Caleb Church.

[9.] Ruth had a second and third husband [see Child, 77, and addition thereto, p. 740.]

[10.] For Scott, read Scotto. This was the m. of Caleb, his father.

[13.] Joshua Warren was admin. of the estate of Caleb Church, his father-in-law.

- p. 159. **CLARKE.**—[1.] It appears by Dr. John Clarke's own statement, in his, "Ill News from New England," that he arrived in Boston in Nov. 1637, and Mr. Savage supposes that the "Mr. Clarke" who was by the Court chosen constable of Watertown, in May, 1632, was the "Mr. William Clarke" who was adm. freeman May 18, 1631. This is very probable, and if so, he soon after left Watertown, as his name is not on the earliest list of proprietors, nor in the town records. [Winthrop, I. p. 74.] As there is no evidence that he remained long in Watertown, it is very probable that he was the William Clarke who accompanied John Winthrop, Jr., in Mar. 1633, when he, with others, went to begin the plantation of Ipswich. What became of him is not shown in Felt's History of Ipswich. It is probable that he was the William Clarke "dwelling between Lynn and Ipswich," licensed by the General Court, June 2, 1641, "to entertain passengers and cattle." The evidence is not conclusive, yet there is good reason to believe, that Dr. John Clarke, the physician, preacher, and civilian of Rhode Island, first settled in Watertown, and that it is his name, which is found on the list of proprietors in 1642; for it is not unusual for a name to remain on that list, after the proprietor had moved from the town. In the first place, Dr. John Clarke, of Rhode

Island, made bequests to his nieces, the daughters of John Fiske, Sen., of Watertown. [See J. Fiske, 1.] In the next place, there seems to have been a particular intimacy and congeniality of sentiments between him and Nathaniel Briscoe, Sen., of Watertown. They were appointed joint executors of the Will of John Hazell, dated Nov. 19, 1651, about the time he (Dr. C.) was released from prison in Boston, and a short time before he and Mr. Briscoe sailed for England. They were, however, to depart so soon, that they gave a letter of attorney to Thomas Broughton, lately removed from Wat. to Boston, son-in-law of Mr. Briscoe, for the settlement of Hazell's estate. The Will was witnessed by John Warren and Thomas Arnold, of Wat., who were also Baptists. About this date (i. e., in Oct. 1651), both these witnesses were fined by the Court, "for an offence against the laws concerning baptism." [See Warren, I., and see Arnold.] Nathaniel Briscoe, Jr., was one of the witnesses to the said letter of attorney. [See General Reg. IV., p. 319.] For the intimacy and co-operation of Clarke and Briscoe in England, the next year (1652), see Briscoe's letter, in Mass. Hist. Coll., vol. I., 3d series. For further information concerning Dr. John Clarke, see Allen's Biog. Dict.; Drake's History of Boston, pp. 325-26; Winthrop, I. 271; Mass. Hist. Coll., 3d ser. vol. viii. p. 292.

- [2.] For a genealogy of the multitudinous descendants of Dea. William and Mary (Clarke) Locke, see "Book of the Lockes," *per totum*.
- [6.] Hugh Clarke, was witness in court, in 1681, then aged about 68, showing that he was born about 1613.
- [8.] Uriah Clarke, d. in Wat., July 26, 1721, aged 77 y. 1 m. 21 d.
- [10.] 1st wife Abigail. He m. (2d), Nov. 18, 1680, Lydia B——. The Inventory of John Clarke, of Newton, was dated Jan. 31, 1694-5. His Will mentions wife (not named), sons John, William, and other younger children. Wit. Hugh Clarke, &c.
- [12.] Mary Clarke, m., in 1730. John Ball [12], his 2d wife.
- [13.] Ann, b. Jan. 12, 1702; m., 1736, Ebenezer Bartlett, of Newton.
- [14.] For Brown, read Bowen.
- [22.] Chil. of William Clarke, of Newton.
1. Elizabeth, b. Aug. 23, 1709.
 2. Norman, b. Feb. 13, 1711.
 3. Sarah, b. Mar. 26, 1714.
 4. William, b. Sept. 10, 1716.
 5. Caleb, b. Oct. 3, 1717.
 6. Hannah, b. Dec. 3, 1719.
 7. Joanna.
- p. 160. [27.] For May 7, read May 27. Uriah Clarke, was selectman of Wat., 1699 and 1700; Martha Pease, is said to have been his 3d wife.
- [28.] Was this the John Clark, who m., in Rox., Jan. 29, 1712-13, Mary Tucker?
- [29.] Thomas, d. Feb. 1, 1719, aged about 40.
- [30.] Mary, was bap. in Rox. Aug. 26, 1683.
- [33.] Uriah, d. in Fram., Feb. 24, 1725; only son Pease, admin'r, wid. refusing to serve. Benjamin Clark [35], of Wat., surety.
- [35.] Benjamin Clark, d. Jan. 17, 1730-31, aged 35.
- [41.] Sarah, m., in 1760, Samuel Phipps, Jr., of Camb., and had an only son, Danforth, grad. Harv. Coll., 1781; d. 1783. She d. about 1829, aged 95.
- [44-2.] John, m. — Hodges, of Salem.
- [44-8.] Martha, m. Timothy Carter Harrington, of Boston. [See Harrington, †145, Part II.]
- [44-9.] For Cuther, read Luther.
- p. 161. [56.] Wife Mary, d. Aug. 10, 1728, aged 39. For (1st), read (2d), and for (2d), read (3d). Richard Clark, d. Nov. 6, 1760, aged 70. He is said to have had 3 wives. I have found no notice of the first wife.
- [58.] 3½ Richard, Jr., b. Feb. 1719; d. Ap. 29, 1723.
- [59-2.] Uriah, d. May 7, 1747.
- [65.] Martha, m. Nehemiah Mason [120].
- [67.] Richard Clarke, d. Feb. 24, 1809, aged 79. His wife, Elizabeth, d. May 8, 1777, aged 42. He was selectman 1778, 81, 86, 87.

p. 162. **CLARY.**—Sarah Clarie was a witness to the Will of wid. Ann Fleming, of Wat., Dec. 29, 1657. Sept. 13, 1670, John Clary [Jr.], sold to Joseph Wellington, 4 acres of land, "formerly of Nicholas Cady, of Groton." Wit., John Clary, Sen., and Sarah Clary. Rev. Dr. Fiske, of Brookfield, in his Historical Discourse, says, John Clary was "shot down" by the Indians; but without stating the date, or whether he was mortally wounded.

OLEMENCE.—(Clements.) At court, Ap. 1655, John Benjamin had assigned to

him the care and custody of the wife of William Clemence, neglected by her husband. Oct. 2, 1655, the care of her was committed to John Fuller, to receive £6 per annum. June 19, 1656, the court refused a divorce to William Clemence. Juda Clement m., Sept. 29, 1659, John Whitney [1.] his 2d wife. [See Jackson's Hist. of Newton, p.260 and 61.]

CLOYSE.—Willis (History of Portland) says, the 2d wife of John Cloyse was Juliana. Had he three wives, or is this a variation or error of Jane? In 1660, he sold land in Charlestown, and moved to Falmouth, Me., and settled on W. the side of Presumpscot River. He is supposed to have been killed by Indians in 1676. [See Barry.]

CODDINGHAM.—In Aug. 1728, James Coddingham and wife moved from Marblehead to Watertown. In Aug. 1742, Rebecca Coddingham (? wife of James) went to Waltham. In Ap. 1742 (or 3), James Cottingham and family moved from Waltham to Cambridge.

COE.—(Coo, Cooe.) Embarked at Ipswich, Eng., Ap. 1634, Robert Coe, aged 38, wife Anna, aged 43, and sons John, aged 8 years, Robert, aged 7 years, and Benjamin, aged 5 years. [They were fellow-passengers with several Watertown families.] He settled in Watertown, where he remained only a short time, being one of the colony that went early to plant Watertown (Wethersfield), Conn. He was adm. freeman of Mass., Sept. 3, 1634, and was dismissed from Wat. Church May 29, 1635, to form (with others) a new church on Connecticut River. In 1641 he moved to Stamford (Rippowams), of which he was an original purchaser. In 1644 he moved to Hampstead, L. I., and was one of the earliest settlers of Jamaica, L. I. His son, Hon. John Coe, was a very early settler of Newtown, L. I., of which he was magistrate 1652, 3, 4, 5, 6, 1, and 2, the first after its organization. [See Hinman's Catalogue; also Riker's Hist. of Newtown; also, Thompson's Hist. of L. Island.]

p. 163. **COLLER.**—June 26, 1652, John Coller, then aged 19, was a servant of Thomas Hammond. Ap. 6, 1658, he was again a witness in Court, then said to be aged 25. John Coller, of Wat., took the oath of fidelity in 1652. Mar. 16, 1684, John Coller was one of the Committee on the highway from Sud., Sherb., Marlb., Fram., and Falls on Charles River. Hannah Coller m. in Wat., June 16, 1679, James Cutting.

COLMAN.—Mar. 12, 1766, Hannah Colman and her infant moved from Woburn to Watertown.

COMMAREL.—May, 1736, Mary Commarel moved from Boston to Watertown.

COMBS.—There was a Jane Combs, alias Ogleesbee, of Wat. and Waltham, in 1742-4.

COOK.—Inventory (no date (?) about 1646), of Thomas Cooke, of Watertown, taken by Nathaniel Bowman and Thomas Hastings, £5 3s. Mentions Mr. Mayhu and Goodman Childs. [Geneal. Reg. vii. 34.]

[1.] Gregory Cook was member of a coroner's jury in Wat., June 15, 1674, and he was selectman 1678, 79, 81. Administration on his estate was granted Ap. 7, 1691.

[3.] For Mr. Angier's Church, read Mr. Bailey's Church.

[4.] Mary, m. Jan. 13, 1712-13, Samuel Morse, of Sherburne; his 2d wife. [Memorial of Morse, p. 22.]

[9.] See Cook [30].

[12.] Stephen Cook, Jr., m. Hannah Fuller. [Fuller 110, Part II.]

p. 164. [30.] The wife of Samuel Cook d. Feb. 10, 1754. The wife of Samuel Cook taught a school in Wat., 12 weeks from Jan. 11, 1767.

COOLIDGE.—On page 186 may be seen *Pedigrees of Cooledges in Cambridgehire*, furnished by Mr. H. G. Somerby. Since that page was printed (autumn of 1852), he has continued his researches in England with gratifying success. We here present the result of these researches, with his introductory or explanatory remarks.

PEDIGREE OF COOLIDGE.

• THOMAS COLYNGE - •••••
 of Arrington; Will dated Feb. 11, 1496; proved in the Bishop's Court of Ely, same year.

William Collynge—Margaret Bell; Will of Arrington, executor to his dated April 18, 1638, father's Will; his own dated proved Jan. 31, 1680, Jan. 12, 1619, proved May 27, 1619.

• John Colynges=Alice, not living in 1624, proved 10 Dec., 1624.
 Agnes, married Hill.
 Alice.

Roger, probably d. unmarried.

Thomas Collynges—mentioned in John's Will, who was probably his father; perhaps d. before 1624.
 John Collynges—son of Thomas, legatee of John in 1524, not 22.

Robert Colege=Jane, widow of= of Arrington, executor of his *** Austen. Dec. 16, 1663; Will dated Dec. 9, 1663, proved Jan. 9, 1664.

John Colledge= Jane, mar. Agnes, mar. *** Ames, of Harlingfield.
 Agnes, mar. *** Lancaster.

Thomas Austen. Jane Austen. Robert Colledge.

Robert Colledge.

William Colledge=Grace. Katharine Colledge, of Arrington, afterwards of Sutton, whose Will was dated Mar. 26, 1682, proved July 19, 1682.

Margaret Colledge, m. *** Malden.

THE ORIGINAL ARMS OF COLYNGE.



Henry Colledge, Robert Colledge= named in his father's Will. June 4, 1660.

John Colledge, Alice, bap. Elizabeth, b. 26 Dec. 1676, bur. 28 Sept., 1676, same day.
 Alice, bap. Dec. 1676, bur. 28 Sept., 1676.

Margaret, bap. at Arrington, Oct. 21, 1641.

Son=

of Willingham; Will dated Ap. 14, 1661, proved May 5, 1661, mentions his sister, Madwyn Beverly, and his brother. Simon and Thomas; speaks of his sister, Madwyn Beverly, and his brother.

Thomas Colledge=Alice Salmound, mar. of Cottenham, bur. 17 Oct., 1652, at C., 14 Nov., 1666.

• Simon Colledge=Jane, of Cottenham, bur. Nov. 10, 1690; Will dated Nov. 6, and proved Nov. 23, 1690; his second wife was Agnes, who survived him. Dec. 5, 1674.

Thomas Colledge, of Downham.

• William Colledge=Margaret Mayoe, of Cottenham, bur. mar. at Cottenham, 26 Oct., 1618; Will 23 June, 1688. She dated 21 Oct., 1618, was bur. at C., 11 Feb., 1620, and proved 31st same month.

John Colledge=Frances Fabram, mar. of Cottenham, bur. 17 Oct., 1652, at C., 14 Nov., 1666.

Edith, bap. Dec. 5, 1674.

Thomas, bap. July 26, 1679, bur. Aug. 13, 1690.

Richard Colledge=Elizabeth Essex, bap. 4 Feb., 1600. William Colledge= m. 5 May, 1616. bap. 4 Jan., 1692.

Thomas Colledge, Elizabeth Colledge, Simon Colledge, bap. 23 July 1696; bur. 23 May, 1698; bur. 1 July, 1697.

Margaret Colledge, bap. 10 Sept., 1602.

• John Colynges—bap. 16 Sep., 1694; was set to New England and settled in Watertown where he died, 7 May, 1691.

Alice, Richard, Sarah, Simon, Elizabeth, William.

Margaret Colledge, bap. Nov. 15, 1612.

PEDIGREES OF COOLIDGES, OF DODDINGTON AND OF LITTLE GRANSDEN.

(EXTRACTED FROM THE BISHOP'S REGISTRY, AT CAMBRIDGE.)

JOHN COOLIDGE—MARGARET.

of Hardwick: Will dated 18 Mar., and proved 19 May, 1665.

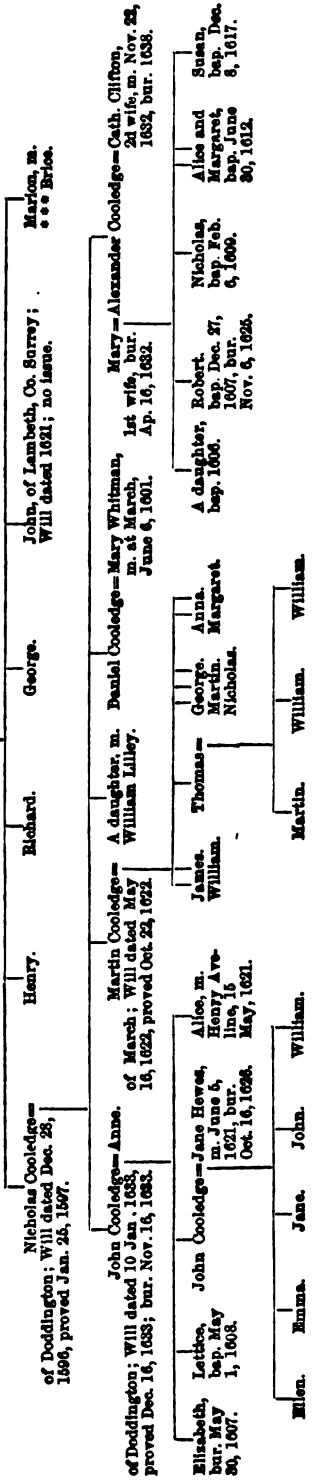

THOMAS COOLIDGE—ELIZABETH,
of Little Gransden: Will dated Dec. bur. Aug. 25,
13, 1616, proved Jan. 9, 1617, buried 1616.
Dec. 14, 1616; mentions grand
mother Joane Hart.

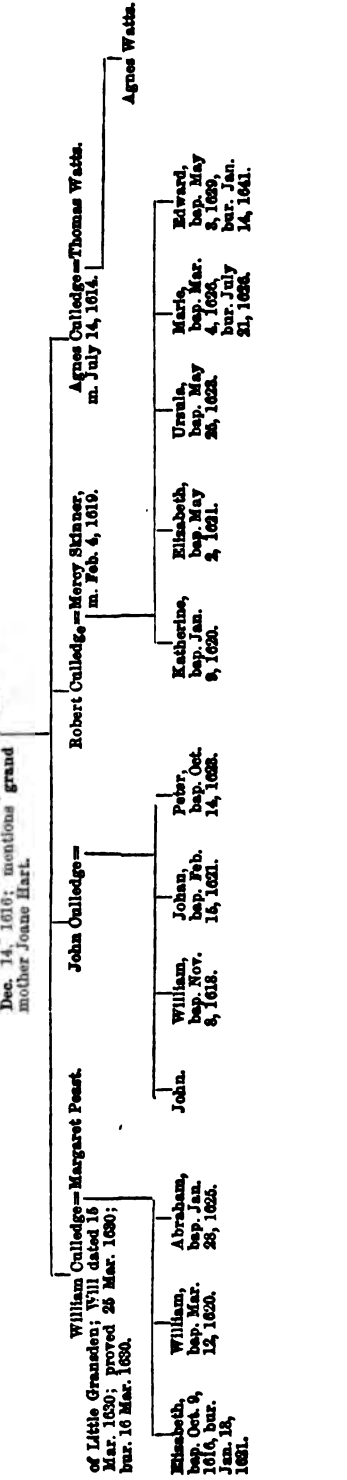

- "It appears in the Rolls of the Hundreds, time of Edward the First, that William de Coulinge held lands in Cambridgeshire, from which one can reasonably infer that the family were seated in that County at that time."
- "The practice of adopting hereditary surnames from manors and localities originated in Normandy about the close of the tenth century, or the beginning of the eleventh. Possessors of land took them from their own estates, a practice in which the Normans were soon imitated by the English, particularly after the Conquest. Many families of Saxon origin copied the example of their conquerors, and prefixed de to their names. In a few instances the article de or d' is still retained; but, generally speaking, it was dropped from surnames about the time of Henry the Sixth. Thus, instead of William de Couling, &c., the landed gentry wrote themselves William Couling, of Couling, &c."
- "The custom of taking names from towns and villages in England is a sufficient proof of the ancient descents of those families who bear them."
- "That the name (Coulinge) is derived from the village of Couling or Cowling in Suffolk, there is not the least doubt, and it continued so to be spelt, with occasional variations, until after the family was seated at Arrington. Probably Collins is derived from the same source. The family of Coolidge of Cambridgeshire is the only one in England, that adopted their peculiar way of spelling the name; the corruption being in consequence of there being no fixed mode of spelling in those days, and persons wrote names as they sounded to the ear. In Burke's Dictionary of Arms are several varieties in the spelling of the name, evidently of one common origin, from the similarity of the arms; the griffin being almost always introduced in some form or another, either in the arms or crest. The fleur de lis seems anciently to have been connected with the family arms."
- "In the year 1327 [1st Edward 3d] Walter Couling, and Ralph Couling, of Wimpole [adjoining parish of Arrington] Co. Cambridge, were assessed to the King's Subsidies. [Subsidy Rolls, Public Record Office, Carlton Ride, London.]
- "The name has undergone various orthographic changes from the time of its adoption from the village of Cowlinge, in Suffolk, on the borders of Cambridgeshire; the first of the name probably being styled de Cowling or de Cooling, as lord of the manor there, which family soon after removed to Cambridgeshire, and spelt the name, at different periods, Couling, Cullinge, Colynge, Cullidge, Coledge, Cowlidge, Cooledge, and Coolidge." (See Pedigrees, pp. 744 and 745.)

- p. 165. [1.] In the 13th and 14th lines from top, for Coalidg and Coalyng, read Coulidg and Coulyng. John Coolidge, Sen., d. May 7, 1691, aged 88; his age corresponding precisely with that in the tabular English pedigree, p. 744. His wid., Mary, d. Aug. 22, 1691, aged 88. The inventory of his real-estate, homestall-house, and 12 acres, £50; 60 A. of remote meadow, £12; 10 A. of woodland, £20; 5 A. in remote meadow, £7; 2 A. in Rock meadow, £4; 6 A. swamp, at home, £20; another homestall, bought of David Fiske, 12 A. £50; 30 A. of dividend land, £8; 2 acres in Rock meadow, £4; 14 acres against Fresh Pond, £20; 7 A. in Pondfield, £14; 3 A. in same field, £6; farm lot, 80 A., £10. (Gravestones in Watertown.)
- [3.] Stephen Coolidge was fined £5 by the town for refusing to serve as constable. If he hire a man to serve, fine to be remitted. Nov. 12, 1692, Court "ordered y^e Watertown selectmen be forthwith sent unto to make known to the Court why Stephen Coolidge may not be released from serving as constable." Admin. of his estate was granted to his brother, Jonathan, Mar. 5, 1710-11. His estate was divided June 18, 1711, to his brothers John (heirs), Simon (heirs), Nathaniel, Jonathan, and sister Mary (heirs). House, &c., given him by his father, appraised at £100.
- [4.] Simon Coolidge was witness in Court in 1659, then "aged about 27;" again witness in Court, June 11, 1662, then aged 30, both showing that he was born in 1632. He d. Dec. 27, 1693, aged 71, and admin. was granted, Jan. 15, 1693-4, to his son Joseph, and his son-in-law, Nathaniel Bright. Inventory, £66 12s. 3d.
- [6.] Nathaniel, d. Nov. 3, 1711.
- [8.] John Coolidge, Jr., was chosen sergeant in June, 1666, was selectman 1684, 86, 87, 88, 89, 90. In the settlement of his estate, or at his decease, he is said to have been aged about 50. This is undoubtedly an error. It probably should be 60 years. He is the first named among his father's sons in his Will, and it is to be observed that he was married in 1655.
- ☞ The marginal figures for reference, from 8 to 20, were thrown into pi in printing, but they will not probably mislead the reader. Hannah, the eldest child of Johu, was born Jan. 29, and not Feb.

p. 166. [21.] For July 14, read 24.

- [26.] Stephen Coolidge m., in Camb., Ap. 30, 1702, Sarah Parker; had dr. Sarah, bap. May 11, 1704, d. Feb. 3, 1704-5. He d. in Camb. 1704, and his wid., Sarah, m Aug. 8, 1708, Nicholas Fessenden, Jr., an eminent schoolmaster of Camb., grad. Harv. Coll. 1701, d. 1719, aged 38. [See Locke Family, p. 314.]
- [28.] Nathaniel Coolidge was selectman 1677. Mar. 20, 1661, he bought of Nathaniel Treadway (and wife Sufferana) his right in the wears in Charles River, near the corn-mill. Also about 2 A. of land, bounded N. by Mill Creek; S. by Charles River: E. by the mill; W. by the stone dam. May 26, 1663, he bought of John Stone, of Sudbury, all his right to the river and fishing wears in Watertown, being the one-half thereof. These wears had formerly belonged to Elder Edward How, and were inherited by his two daughters, the wives of Treadway and Stone. July 3, 1664, he bought of John Knapp and wife Sarah, 93 acres, formerly belonging to William Knapp. Ap. 2, 1667, he bought of Samuel Daniel and wife Susanna 117 acres in waste lands, No. 3, lot 90. Aug. 10, 1672, he bought of Robert Jennison 50 A. farm lands, bounded South by John Livermore [the "Cowpen Farm"]; N. and W. by N. C.; E. by Simon Coolidge. June 10, 1672, he bought of Richard Blois the reversion of about $7\frac{1}{2}$ acres, in two parcels, situated near the meeting-house in Wat., to have and to hold immediately after the decease of Richard Blois.
- [37.] Experience, the 2d wife of Jonathan Coolidge, was b. in Boston, Feb. 23, 1687, and was a dr. of Timothy Thornton, a merchant, of Boston, and wid. of Ebenezer Wakefield. [See Thornton, 12.]
- [43.] It is not satisfactorily ascertained whether this Hannah Coolidge was the one who m. Richard Coolidge, Jr. [75], or Samuel Myrick [5].
- [46.] Anna Coolidge, m. (1st), Nathaniel Adams, a blacksmith, of Charlestown. Chil., 1. Mary, b. 1704; d. aged 13. 2. Anna, b. 1709. He d. July 11, 1710; and his wid. m. (2d), Nov. 18 (marriage covenant dated Oct. 29), 1716, Benjamin Lawrence [6, and Part II.]. She d. Dec. 28, 1718, aged 47. Her Will, dated Dec. 18, 1718, proved Jan. 23, 1718-19, mentions only child Anna Adams; her husband, Benjamin Lawrence; sister, Hepzibah Coolidge; brother, Joseph, and his dr. Susanna; brothers, Nathaniel, John, Thomas, and Jonathan. Inventory, dated Jan. 6, 1718-19, £185 5s.
- p. 167. [49.] For Shooner, read Spooner.
- [50.] Allen Brown, returned from Boston to Watertown, in July, 1738 [see p. 731].
- [64.] For Hassel, read Russell, of Charlestown, 8 chil.
- [66.] Lieut. R. Coolidge, was selectman, of Wat., 1711, 15, 18, 19, 20, 22, 23, 24, 26, 27, 28. His first wife Mary, d. May 21, 1700, aged 31.
- p. 168. [75.] Chil. of RICHARD COOLIDGE, Jr.
 1. Elizabeth, b. Nov. 23, 1729. 2. Mary, b. Nov., 1731.
 3. Abigail, b. Jan. 3, 1733-4. For the parentage and lineage of his first wife Mary, see Trowbridge [19], in Part II.
- [78.] Samuel Coolidge, was schoolmaster, of Wat., 1725 and 1751. With a liberal education and fine talents, his history is one of the very numerous illustrations of the sad effects of intemperance. On Thanksgiving-day, Nov. 4, 1743, a collection was taken for Samuel Coolidge, to be laid out for clothing, &c., by the deacons. He was buried at the town charge, Jan. 13, 1767, aged 63.
- [79.] Jonas Coolidge, was a house-carpenter. Previous to 1764, he and his son Samuel, had boarded with his brother-in-law, Timothy Thornton [20]. Aug. 26, 1766, Benjamin Felton had been the guardian of Jonas Coolidge (non comp.), and then other guardians appointed. He d. previous to Ap. 27, 1767.
- [81.] Ebenezer, d. Oct. 24, 1750. [82.] Elizabeth, d. Sept. 12, 1749.
- [85.] For Feb. 16, 1714, read 1713-14.
- [88.] OBADIAH COOLIDGE, moved to Fram., in 1728, and probably thence to Marlboro. He had a 4th child *Obdiah*. It was probably this son Obdiah Coolidge, who m., in Rox., July 30, 1750, *Sarah Davis*. May 29, 1767, administration on the estate of Obdiah Coolidge, victualler, of Roxbury, was granted to wid. Sarah Coolidge, and Caleb Davis, shopkeeper, of Boston, and the guardianship of eight children, all under 14 years of age. viz., Joshua, Rebecca, Isaac, Davis, Asa, Sarah, Caleb, and Lucy. [Suff. Prob. Office, vol. 66, p. 12.] *Caleb Davis Coolidge* (? son of Obdiah), m. in Boston, Oct. 10, 1776. He m. (2d), about 1784, *Rebecca Edwards*. Chil.,
 1. Mary Edwards, b. July 4, 1785.
 2. Nathaniel Davis, b. Nov. 28, 1787; d. in infancy.
 3. Eliza Frazer Lincoln, b. Oct. 29, 1789. 4. Matilda D., b. May 6, 1792.
 5. Sarah Pierpont, b. Nov. 24, 1796. 6. Matsy Latham, b. May 12, 1797.

7. Sophia Bethsheba, b. Oct. 20, 1799; m. Thaddens Allen.
8. Caleb Davis, b. Mar. 11, 1802; d. aged 21.
- p. 169. [100.] June 16, 1709, Nathaniel Coolidge [28], and wife Mary, sold to son Nathaniel, one-half a farm, the whole 77 acres; the side (or part) whereon N. C., Jr., lives; bounded W. by the other half; E. by heirs of Joseph Harrington; N. by squadron line; S. by Watertown Cowpen. Also, one-half a farm, the whole 100 acres, bounded E. by Nathaniel Bright; N. and S. by squadron lines; W. by the other half of said farm.
- [107.] Thomas Coolidge, was selectman, of Wat., 1726, 33, 34, 35.
- [111.] Dea. John Coolidge, d. Ap. 2, 1755, aged 81. He was selectman 1738 and 41, and town clerk, 1725. Jan. 9, 1710-11, he bought of James Treadway and wife Sarah, a house and about 30 acres, bounded N. by Samuel Eddy, and Robert Goddard; W. by Robert Goddard, and Caleb Church; S. by county road; E. by county road and Samuel Eddy. It is probable that J. Treadway, soon after this sale, moved to Colchester, Conn.
- [118-5.] Judith Coolidge, of Ashburnham, m., in Lunenburg, Ap. 14, 1784, Isaiah Stone, of Dummerston.
- [120.] Capt. Joseph Coolidge, was selectman 1732, 39, 42. His first wife Elizabeth, d. Nov. 9, 1736. His 2d wife d. Mar. 7, 1754.
- p. 170. [123.] Samuel Coolidge enlisted Mar. 12, 1745-6, to go to Cape Breton.
- [124.] Benoni, d. May 3, 1754, aged 31.
- [125.] Mercy (Coolidge) Stratton, d. Ap. 12, 1749, 12 days after marriage.
- [129.] Benjamin, b. Ap. 14, 1717.
- [142.] Martha, b. Nov. 1, 1724.
- [143.] James Coolidge, m., Sept. 11, 1728, Freelove Monk, b. May 2, 1704, dr. of Elias and Hope Monk, of that part of Dorchester which is now Stoughton. [See Mason, 13.]
- [148.] Lieut. Nathaniel Coolidge, a house carpenter, was selectman of Wat., 1751, 55, 58, 59, 60.
- p. 171. [155.] For [Warren, 36], read [Warren, 30].
- [161.] David Coolidge, d. Dec. 20, 1772; and his wid. Mary, d. May 14, 1786.
- p. 172. [176.] Samuel Coolidge, d. Sept. 27, 1753, aged 31.
- [177.] For dr. of Thomas Tileston, read Elisha Tileston. His son, Elisha Tileston Coolidge, now (1853) lives in Cincinnati.
- [179.] Capt. John Coolidge, m., May 29, 1739, Anne Russell, (?) b. Feb. 10, 1715, dr. of John, of Woburn, who m., Nov. 27, 1711, Joanna Winn.
- p. 174. [240.] Patty, m. Josiah Fiske. [See N. Fiske, 109.]
- [249.] Nathaniel Coolidge, selectman, of Wat., 1777, 78.
- [252.] For the lineage of Elizabeth Fessenden, see Locke Fam., No. 371, 101, 24.
- p. 175. [267.] Chil. of NATHANIEL and CATHERINE (Baldwin) COOLIDGE, of Worcester.
1. *Nathaniel*, b. Aug. 14, 1787; a merchant, and a deacon, of Hadley; m., Nov. 11, 1812, *Lucy Porter*, dr. of Gen. Samuel Porter, of Hadley. [See Phillips, App. III. 19, in Part II.] He d. Ap., 1835; 4 chil., all d. young.
 2. *John*, b. Mar. 1, 1789; a saddler, of Worcester, where he died.
 3. *Baldwin*, d. young, in Worcester.
 4. *Sarah*, m. — *Rodgers*, a printer. She d. in Wor., leaving one son, *Henry*, a printer, of Boston.
 5. *William*, a baker, of New Haven, where he m. and died.
 6. *Catherine*, m. *Joseph Marsh*, a farmer, of Hadley. She d. leaving chil.
 7. *Dorothy*, m. *John Eaton*, a merchant, of Worcester; both d. leaving dr. Catherine.
- [269.] Gov. Carlos Coolidge, m. Harriet Bingham, of Claremont, N. H. One child, *Mary*, m. Rev. Franklin Butler, of Windsor.
- [271.] *Betsey*, of Hadley, unm.
- p. 176. [308.] For Higham, read Hingham. Strike out, the late. Prof. Norton is living.
- [309.] For 1. Edward, read 4. Edward.
- [309-2.] For Oct. 4, read Oct. 11. [309-4.] Thomas, d. Oct., 1847. Edward, has 5. Anna Cornelia, b. Nov. 29, 1845. 6. Henrietta Goddard, b. Dec. 15, 1847.
- [310.] *Jane*, m., Nov. 20, 1850, *Henry Grew*, merchant, of Boston.
- [313.] Dr. S. Wigglesworth, m. Louisa Goddard Davenport, dr. of the late Isaac, Esq. and Mary (May) Davenport. Dr. W. d. Ap. 7, 1847. Chil.,
1. Samuel Norton, b. Aug. 23, 1845.
 2. Francis Thomas, b. Sept. 17, 1846.

- p. 179. [339.] Peter Coolidge, d. Nov. 3, 1851.
 [341.] For Josiah, read Josiah Adams, now (1852) of East Lexington.
 [342.] For Hemenway, read Hemenway.
 [350-3.] George, d. June, 1826, unm. [350-5.] Lucy Wyeth, d. Nov. 1837, unm.
 [305-8.] For Hawes, read Harvey.
- p. 181. [394.] Col. Moses Coolidge, was selectman 1793, 94, 95, 96, 98, 99, 1800, 1, 2, 3. Hannah Stowell, 5th child of Col. Moses C., is now (1855) living in Watertown.
 [402.] For Marguerita, read Marguerite. For Dr. Joseph Wheeler, read Rev. Joseph Wheeler, grad. Harv. Coll., 1757, d. 1793.
 [403.] Joseph Coolidge, Esq., was an eminent merchant, of Boston. In early life he was an ardent "son of liberty," and one of the celebrated "Boston tea-party."
 [404.] Joseph Coolidge, was an eminent and successful merchant, of Boston. He was educated at the Royal Military College of Sorez, in the south of France, and afterwards travelled some time in Europe. For granddaughter, read great granddaughter, of Adino, &c. For June 29, read Jan. 29.
 [405.] Elizabeth Coolidge, m., Jan. 15, 1822, Tasker Haggard Swett, Esq., merchant, of Boston, son of Dr. John Barnard and Charlotte (Bourne) Swett, of Newburyport. He d. Sept. 2, 1841. For Sergeant, read Sargent. [For an account of the lineage and family of Dr. J. B. Swett, see Thatcher's Med. Biog. II., p. 106.]
 [406-6.] Thomas Jefferson Coolidge, m., Oct. 4, 1841, Hetty, dr. of Hon. William Appleton.
- p. 182. [414.] For Templeton, read Templeman.
 [426.] For Carter, read Cartee. Dr. C. S. Cartee, was formerly of Providence, is now (1853) master of a Grammar School; has been superintendent of a Sunday-school, and is author of works for Sunday schools.
- p. 183. [440.] For High Sheriff, read Deputy Sheriff.
 [441.] Charles A. Coolidge, m. a dr. of Henry Rice, of Boston.
 [446.] For Laomi, read Loami.
 [448.] In 1852, Rev. Dr. Park was elected President of Racine College, Iowa.
 [449.] Oliver B. Coolidge, m., Ap. 18, 1825, Almira, dr. of Daniel and Hannah (Wright) Wyman.

p. 187. COREY.

- [11.] ISAAC COREY, of Weston, m., Ap. 12, 1739, ABIGAIL PRIEST [27.], of Waltham.
- 12 1. ISAAC, b. Jan. 9, 1739-40; a soldier, at Lake George, in 1758, in Capt. Jonathan Brown's Company. He m. RUHAMAH ——. He moved to Sud., after the birth of two chil., viz., 1. *Abigail*, bap. in Waltham, May 20, 1764. 2. *Leonard*, bap. Ap. 30, 1769.
- 13 2. TIMOTHY, b. Oct. 27, 1741; m. (pub. Sept.), 1766, ELIZABETH GRIGGS, of Brookline, where he settled. Chil.,
- 14 1. *Elizabeth*, b. Dec. 19, 1767; m. (1st), Nov. 26, 1788, *John Corey*, a distant relative, of Marlboro, who settled and d. in Brookline. She m. (2d), *John Welch*, who d. in Boston. She d. in Newton, Oct., 1846. Chil.,
 1. Harriet. 2. Elizabeth. 3. Ann. 4. Caroline.
- 15 2. *Amelia*, b. Nov. 12, 1769; m. (1st), *Moses Robbins*, of Brighton. She m. (2d), *Ebenezer Brown*, of Brighton. She d. in Cambridgeport, Mar., 1840. Chil.,
 1. Polly (Robbins). 2. Eliza (Robbins).
 3. Ebenezer (Brown). 4. Amelia (Brown), m. Aaron Corey. [17.]
- 16 3. *Elijah*, b. Nov. 7, 1773, now (1855) a deacon of the Bap. Church in Brookline, and a trustee of Newton Theol. Sem.; m. (1st), Nov. 17, 1797, *Polly Leeds*, of Dorchester, b. July 14, 1779. She d. Oct. 21, 1827, and he m. (2d), Jan. 19, 1829, wid. *Lucy (Stearns) Davis*, s. p. [I. Stearns, 328, V.] Chil.,
- 17 1. Aaron, b. Oct. 23, 1798; of Cambridgeport and Alton, Ill.; m. his cousin, Amelia Brown.
- 18 2. Elijah, b. Aug. 14, 1800; d. June 28, 1843, of Brookline; m., May 5, 1821, Mary Richards, b. Mar. 10, 1800; d. Sept. 15, 1848. Chil.,
 a 1. Charles R., b. Nov. 4, 1822; m., Ap. 25, 1844, Eliza Wetherill, of Worcester, where he d. July 21, 1851.

- b 2. Amanda Maria, b. Oct. 28, 1824; m., May 8, 1844, James Edmond, of Portland; and they have resided in Brookline, Philadelphia, and again in Brookline. She has published a small volume of poems, and several tracts for youth, which have had an extensive circulation.
- c 3. Francis Henry, b. Jan. 27, 1827, of Brookline; m., Sept. 2, 1847, Lucy Stearns. [I. Stearns, 326 e, p. 516.]
- d 4. Mary Cornelia, b. Jan. 15, 1831.
- e 5. Frederick Adolphus, b. June 20, 1833.
- f 6. Theodore Franklin, b. Oct. 17, 1836.
- 19 3. Timothy, b. June 21, 1803; d. Feb. 21, 1807.
4. Mary Glover, b. Mar. 20, 1806; m., May 18, 1830, Rev. John Pratt, b. in Thompson, Conn., grad. Brown Univ. 1827; a professor in Granville Coll., O.
- 20 5. Elizabeth Griggs, b. Nov. 21, 1809; m., Feb., 1830, Rev. Barnas Sears, grad. Brown Univ., 1825; D.D. Harv. Univ., 1841; some time professor and president of Newton Theol. Sem.; now (1852) superintendent of the public schools of Mass. Among his literary productions is the Life of Martin Luther.
6. Timothy, b. Ap. 21, 1811; d. Oct. 22, 1816.
- 21 4. Julia, b. Feb. 4, 1776; d. July 15, 1852; m., Jan. 25, 1801, William Cheever, of Chelsea. Chil.,
1. Charles. 2. George. 3. William. 4. Abby. 5. Susan. 6. Harriet.
- 22 5. Anna, b. Mar. 19, 1778; m., Oct. 27, 1803, James Leeds, of Dorchester. Chil., 1. James. 2. Timothy. 3. Elizabeth.
- 23 6. John, b. Mar. 18, 1780; d. July, 1831, unm.
- 24 7. Timothy, b. Ap. 2, 1782; a dea. of the Bap. Church, in Brookline; d. Aug. 10, 1844. He m., Nov. 16, 1806, Mary Gardner, of Brookline, b. Sept. 2, 1782. Chil.,
- a 1. Caleb G., b. Feb. 10, 1809; d. Mar. 3, 1837, in Brookline.
- b 2. Mary Ann, b. Nov. 30, 1810. 3. Sarah, b. July 29, 1812.
4. Timothy, b. June 11; d. Sept. 18, 1814.
- d 5. Susan G., b. Mar. 20, 1816; m., May 19, 1840, Gilbert G. Pullen, of Augusta, Me.
- e 6. Lucy Maria, b. Dec. 29, 1819; m., May 7, 1849, Rev. Joseph Ricker, of Belfast, Me.
- f 7. Timothy, b. Mar. 2, 1822.
- g 8. Eliza, b. July 26, 1824; m., Jan. 1, 1851, George Brooks, of Rox.
- h 9. Abigail J., b. Nov. 16, 1826.
- 25 8. Sally, b. Ap. 8, 1786; m., Dec. 26, 1815, William Graves, of Washington, N. H. Chil.,
1. William. 2. Thomas. 3. Howard.
- 26 9. Susan, b. May 4, 1788; m., May 26, 1813, John Dean, of Cambridgeport. Chil.,
1. Mary. 2. Catherine. 3. Susan. 4. Sarah. 5. William.

p. 188. **CORNISH.**—Sarah, dr. of Mary Cornish, bap. by Mr. Angier, Oct. 7, 1716. The mother (Mary Cornish, alias Bemis), was living in Waltham, as late as 1748, and the daughter Sarah, as late as 1756.

COX.—William Cox of Waltham, was Lieutenant under Capt. Jonathan Brown, at Lake George, in 1758. Elisha Cox, aged 38 (b. in Dorchester), enlisted in 1760. Benjamin Cox, aged 20, enlisted in 1760.

CRAWFORD.—Oct. 6, 1634, the court appointed Lieut. Feake, Mr. R. Brown, Mr. Pendleton, and Ephraim Childs, to take an Inventory of the goods and chattels of Mr. — Crawford, lately deceased. [See Winthrop, I., p. 138.]

CRAWLEY.—Abraham Crawley, d. about 1768, insolvent.

CRISPE.—Jan. 29, 1631–2, the court appointed 5 commissioners on the Inventory and distribution of the estate of "Mr. Crispe." As most of the Commissioners were Watertown men, he probably belonged there.

Benjamin Crispe, returned from Groton to Watertown, as early as 1681. The selectmen of Wat., on May 24, 1681, chose Benjamin Crispe, in room of Goodman Bloise, to take care of the meeting-house, salary £4 10s., also to be pound-keeper. He m. for his 2d wife Joanna, wid. of William Longley, Sen., of Groton. In her Will, she is said to be "of Groton," but she d. in Charlestown [gravestone], Ap. 18, 1698, aged 79. [William Longley, Sen., of Groton, d. Nov. 29, 1680. His Will, dated Nov. 23, 1680, proved Ap. 1681, mentions sons John and William, and 4 daughters, viz.,

1. Mary Lemond (by husband Samuel, had Samuel, b. Ap. 29, 1667).
2. Hannah Tarball (m., about 1666, Thomas Tarball, Jr. [2.] 4 chil.)
3. Lydia Nutting (wife of James N., of Groton. 6 chil.)
4. Sarah Rand (b. in Lynn, Oct. 15, 1660; m. (1st), June 17, 1679, Thomas Rand, Jr., (? of Charlestown). She m. (2d), before 1710, ——— Watt.)

His wid. Joanna, in her Will, mentions two granddaughters, Mary and Elizabeth Shaddock. Their parentage not ascertained. Is this name Shattuck, or Chadwick ?]

CROSBY.—See p. 453, note.

CROSSMAN.—Abigail Crossman, alias Peirce, dismissed from Waltham, to Easton, Oct. 3, 1737.

CROW.—Robert Crow, moved from Salem to Wat., Ap., 1738.

- p. 190. **CUTLER.**—[23.] Joseph Cutler, d. in Wat. (Waltham), Dec. 23, 1715. Feb. 23, 1709–10, Joseph Cutler, of Wat., sold land to Thomas Saunders, of Wat. [Saunderson, 5.] May 30, 1715, selectmen appointed Joseph Priest, to take of Joseph Cutler, sick, &c. Dec. 23, 1715, they ordered inquiry to be made into the estate of Joseph Cutler, deceased. [Wid. Bridget Giles, of Lynn, in her Will, dated Jan. 14, 1668–9, proved Nov. 30, 1680, mentions her son Samuel Very, and his dr. Bridget; son, Eleazer Giles; son, John Giles, ex'r.; Mary, wife of Thomas Cutler, of Reading.]
- p. 191. [42.] Mary Cutler, m., about 1698, William Munroe, Jr., of Lex. [See Locke Family, p. 306.]
- [58.] John Cutler. [See Hist. of New Ipswich, p. 356.]
- [67.] After Whitney, insert [95].
- [68.] Elisha Cutler, selectman, of Waltham, 1778 and 79.

- p. 192. **CUTTER.**—[1.] After Frances, insert Perryman.
- [15.] In 1696, the house-lot of Ephraim Cutter, was bounded E. by Wm. Knapp, and meeting-house lot; N. and W. by highway; S. by Nicholas Guy's farmland. His wife Bethia, d. in Wat., Sept. 18, 1731, aged 72.
- [24.] Mary "Cutler," bap. in Weston, Jan. 1721–2, dr. of Jonathan and Abigail, who had o. c. in Lexington. Jonathan Cutter d. in Wat., Nov. 25, 1703, aged 17 yrs. 7 mos. [The parentage of that Jonathan Cutter who m. Abigail Bigelow has not been ascertained.]
- p. 193. [26.] It is not clearly ascertained that this is the Hannah who m. Eben. Chinery. [26½] 5½. dr. Abigail d. Nov. 26, 1702, aged 9 yrs.
- [44.] Sarah, m. Dec. 5, 1700, James Locke. [See Locke Family, p. 21.]

- CUTTING.**—[1.] Inventory of Richard Cutting, Mar. 31, 1696, by John Page, Sen., Edward Harrington, and Abraham Brown. Homestall and 4 other lots, £185 17s. Mary Cutting was a witness, June, 1659, then aged about 33 years.
- [8.] June 13, 1721, James Cutting, of Wat., aged 73, answering complaint for his not attending public worship, informed the court that the weather was cold, and being gouty and infirm, he could not attend. He was dismissed, paying costs.
- p. 194. [13.] He, David, and wife Elizabeth, moved to Lexington before July 13, 1714.
- [37.] Capt. John Cutting, selectman of Wat., 1719, 20, 23.
- [50.] Abraham Nutting. [See Saltonstall, 35, in Part II, Note 9.]
- p. 195. [70.] Jonathan Cutting and wife Sarah o. c. in Westboro. May 22, 1744, and had sons Josiah and Daniel, bap. same day. Soon after they moved to Shrewsbury.
- p. 196. [72.] In Mid. Court C. P., in 1730, there was a suit vs. "Jonas Cutting, of Lancaster, alias of Watertown."

CURTIS.—May 20, 1717, Ephraim Curtis, of Sud., gentleman, for £50, sold to John Sterns, of Wat., 50 acres in Worcester [see C. Stearns, 149]. May 20, 1703, Philip Shattuck executed a deed for 3½ acres in Sud. to Joseph Curtis [his heirs], possession given 10 years ago. At this date Abigail was wid. and executrix of Joseph Curtis,

DANA.—Timothy Danney [? Dana] moved from Boston to Wat., Oct. 1, 1764.

DANFORTH.—[1.] For Framingham, read Framlingham. For Ap. 1637, read 1638.

[2.] For Bulcher, read Belcher.

Mr. Nicholas Danforth had a third daughter, *LYDIA*, (probably his fourth child, b. about 1624,) who m., Dec. 9, 1643, *WILLIAM BEAMAN*, of Saybrook. She d. Aug. 16, 1686, and he d. Feb. 4, 1698-9. [See Mass. Hist. Coll., 4th Ser. I., p. 50; also Caulkin's Hist. N. London, p. 341.] Chil.,

1. *Lydia*, b. Mar. 9, 1644, m. (1st) Feb. 3, 1667, *Samuel Boyes*. She m. (2d) Ap. 15, 1684, *Alexander Pygan*, of New London, his 2d wife.

1. *Lydia* (Pygan) only child by this husband, b. Jan. 10, 1684-5; m., Dec. 15, 1709, Rev. *Eliphalet Adams*, of New London. [See Manning [7] p. 523, and Part II.]

2. *Mary*, b. Nov. 12, 1647.

3. *Elizabeth*, b. Mar. 2, 1649, m. about 1677, Capt. *John Chapman*, of Saybrook, afterwards of Haddam, Conn. 10 chil, 5 of whom m., and were living in 1712. [See Chapman Family, pp. 38 and 347.]

4. *Deborah*, b. Nov. 29, 165-. 5. *Rebecca*, b. Sept. 7, 1659.

p. 197. [15.] Jonathan Danforth, Jr., d. (? in Camb.) Nov. 13, 1682, two hours before day. [Geneal. Reg. vii. 57.]

[13. Note.] *Mary Danforth* was the 2d wife of *Solomon Phipps, Jr.* Her second husband was *Thomas Brown*, of Sudbury. Ap. 3, 1670, *Solomon Phipps, Jr.*, and *Mary*, his wife, "the worshipful *Thomas Danforth's* daughter," were adm. f. c. in Charlestown.

DANIELS.—Robert Daniels d. July 6, 1655 [Camb. Records.] He was released from training Ap. 1655, probably on account of his age. He was upwards of 60 years old. After 1651 he moved to Cambridge. *Reana Daniels*, of Camb., was probably his widow, who afterwards m. — *Frost*. Jan. 7, 1656-7, *Reana Daniels*, of Camb., sold to *John Whitney* 40 acres of great dividend land, 13th lot, 4th division, bounded N. by Camb. Line, E. and W. by *Richard Waite*; S. by highway; deed acknowledged by *Reana Frost*. Ap. 12, 1669, *Robert Daniels*, who sold land in Wat. in 1661 and 1662, and whose Will was dated in Sud., 1661-2, was probably a son of that *Robert*, who moved from Wat. to Camb., and d. there. It is also probable that *Samuel Daniels*, of Wat., was his son. Ap. 2, 1667, *Samuel Daniels*, planter, of Wat., sold to *Nathaniel Coolidge* 127 acres in the waste lands, No. 3, lot. 90. [For Ap. 26, 165-, read 1656.]

DAVIS.—In 1677, *Benjamin Davis* was put out or bound to *Joseph Underwood*. Mar. 29, 1692, wid. *Underwood* was warned for having taken into her family *Benjamin* [? *Benanuel*] *Davis*, and his family, and the Court disallowed him to be an inhabitant of Watertown. Jan. 1740, *Mary Davis* went from Wat. to Camb., and was "cautioned" against settlement.

DEAN.—Feb. 11, 1700-1, the town refused to pay the demands of *Joseph Dean* for serving as constable. He probably resided in the Farms (Weston). *James Dean* moved from Camb. to Wat. in Jan. 1741.

DENGAYNE.—(Dingham). *Henry Dengayne*, a "townsman then inhabiting" (1636), to whom a lot of Beaver Brook Plowland was granted, was probably the "Doctor Dingham" mentioned as a grantee of land in Wat., in a deed, Dr. *Philip Shattuck* to *Jona. Smith*. [Mid Deeds, Vol. X., p. 52.] He was an early proprietor of Dedham, and was probably the "Mr. Henry Dingham" who m., in Rox., Ap. 1641, *Elizabeth Alcock*, wid. of the Dr. and Dea. *George Alcock*, who d. Dec. 30, 1640. He d. in Rox., of apoplexy, Dec. 8, 1645. Nov. 4, 1646, the petition of *Mrs. Dingham* and *John Alcock*, for division of the houses and land (two-thirds to *John*, eldest son, and one-third to *Samuel*, b. Ap. 16, 1637), was granted by the General Court. [Colon. Rec. II., p. 165.] This was a few months after *John* had grad. Harv. Coll., and about 13 years before *Samuel* graduated. See Will of *George Alcock* [Geneal. Reg II., p. 104] wherein is mentioned only two children, *John* and *Samuel*, and wife, not named. Also, see p. 627, note.

p. 198. **DENNIS.**—Sept. 1743, *William Dennis* moved from Boston to Watertown. In Ap. or May, 1748, he moved from Rox. to Watertown.

DENKLER.—This name is sometimes written Dunkler, Dunklin, and Dunklee.

DILL.—George Dill came to Wat. 1671, warned out Sept. 5, 1671, and d. there, a pauper, in 1715–16. [See Colonial Records for May 10, 1648, II., p. 242.]

- p. 198. **DIX.**—[1.] It was for a time supposed that Edward Dix and Jane Wilkinson, who embarked at Gravesend in Jan. 1635, were married after their arrival, and became the ancestors of all the Dix families in Watertown and that vicinity. This supposition is not yet, I think, entirely disproved, although later investigations have rendered it questionable. It is now supposed that Edward Dix, of Watertown, was the "Edward Deekes" who subscribed at the church gathering in Charlestown, Aug. 27, 1630 (and must therefore have come over in the fleet with Gov. Winthrop, or very soon after) and the "Edward Dixe" who was adm. freeman Mar. 4, 1634–5. Perhaps he returned to England for a wife. In subscribing at Charlestown, his name immediately succeeds that of Henry Bright, who also went to Watertown; and, in the list of freemen, his name is in the midst of other Watertown names. He was a selectman 1650, and he had been a constable previous to Ap. 1651, when he, and others with him, were fined by the Court, each 10s. for not providing half-bushels for standards, when constables. Ap. 2, 1661, wid. Susanna Dix brought suit against Serjt. John Wincol and John Dix, Exrs. of Edward Dix, for her dowry. Verdict for the plaintiff, viz., one-third rents and the costs, 13s.
- [6.] 5. Deborah, &c. She was not a daughter of Edward Dix. Dr. T. W. Harris says, she was doubtless a widow, for she had sons Leonard Dix, John Dix, and William Dix, who were settled at Hartford, Conn. Who her first husband was is unknown to me; Richard Barnes was her 2d husband.
- [7.] Elizabeth, wid. and ex'x of John Dix, with her son Edward, signed a deed, Ap. 17, 1719.
- [10.] Abigail Dix m., Dec. 10, 1701, Jonathan Grout, of Sud. [See Grout.]
- [20.] After Suffie, insert (? Sophia, or Sufferana).
- p. 199. [29.] For May 9, 1752, read, Feb. 14, 1754. For May 23, read Mar. 3, 1783. The Will of John Dix, of Waltham, yeoman, dated Jan. 30, 1783, proved Sept. 5, 1787, 1st. Gives wife Rebecca, as her right of dower, the use and improvement of one-third real and personal property during life. 2d. To son Samuel Dix, £100 lawful silver money. 3. To son Jonathan Dix, £50, lawful silver money. 4. To drs. Mary Smith and Lydia Bemis, £5 lawful silver money; and to heirs of dr. Abigail Symmes. Son Joel Dix executor and residuary legatee.
- [31.] In 1804, Mary, dr. of John Dix, was wid. Mary Smith. See her father's Will.
- [35–1.] For 1. Sarah, read 1. Abigail.
- [35–8.] For Dec. 30, read Dec. 3. [36.] For May 9, read May 7. [37.] For Sarah Jaffney, read Jaffrey.
- [41.] For 1726, read 1725.
- p. 200. [43.] For Brigham read Bingham. For Jan. 11, read Jan. 10.
- [45.] For 27, read 29. [46.] For Daniel, read Daniels.
- [49.] For Brigham's, read Bingham's.
- [52.] Jonas Dix, Esq., d. Aug. 30, 1783, and his wid. d. Feb. 13, 1793. When Dea. Elijah Livermore [158] moved into Maine, he sold his farm (now the Lyman Farm) to Jonas Dix. He had a third child, Anna, who m. Sept. 10, 1766, Joseph Wellington.
- [41.]
- p. 201. [74.] For 1796, read 1795.
- [75.] Mary, wid. of Rev. Dr. T. M. Harris, d. in Boston, Dec. 5, 1852.

DOLBEAR.—(Dolbier) Benjamin Dolbier m. at King's Chapel in Boston, Feb. 18, 1760, Hepzibah Peirce, bap. in Hopkinton, Ap. 18, 1731, dr. of Thomas and Hannah (Locke) Peirce. [Locke Fam., p. 57.]

DOW.—HENRY Dow d. in Hampton, 1659, and his wid. MARGARET m. Oct. 23, 1661, Richard Kimball. Chil.,

1. *Henry*, b. in Eng., 1634; d. May 6, 1707; m. June 17, 1659, *Hannah Page*. Two other children, b. in Eng., probably d. young.
2. *Thomas*, buried in Wat. July 10, 1641.
3. *Joseph*, b. in Wat. Mar. 20, 1638–9, d. Ap. 4, 1703; m., Dec. 17, 1662, *Mary Sanborn*.

4. *Daniel*, b. in Wat., Sept. 22, 1641; m., Nov. 13, 1673, *Elizabeth Lamprey*.
5. *Mary*, b. in Wat., Sept. 14, 1643.
6. *Thomas*, mentioned in his father's Will.
7. *Jeremiah*, b. Sept. 6, 1657; mentioned in his father's Will.

There was a *Thomas Dow*, and wife *Phebe*, of Newbury as early as 1642. [See Coffin, p. 301.]

p. 202. **DRAPER**.—John Draper, wife Ann, and dr. Ann, moved from Rox. to Watertown, in Ap. or May, 1762. Katherine Draper, moved from Dedham to Wat., previous to Dec., 1761. Mary Dusser [? Dresser or Draper], moved from Rox. to Wat., May, 1764.

DUN.—Henry Dun, moved from Sud. to Wat., Mar. or Ap., 1739.

DUNSTER.—May 15, 1696, Mehitabel Dunster, warned out of (i. e. against settlement in) town.

DUPERY.—For b. Mar. 10, read d. Mar. 10.

DWIGHT.—John Dwight, besides his homestall, owned 30 acres of dividend land in Wat. His grandson, Eleazer Phillips, was born in Dedham, Jan. 30, 1641–2. John and Hanna Dwight had, in Dedham, Mary, b. July 25, 1635; and Sarah, b. June 17, 1638. John Dwight, d. in Dedham, 24, 1 mo., 1638. It seems to me probable, that John Dwight came to Wat., with sons Timothy and John, and dr. Anne, who m. Henry Phillips; that John, Jr., d. 1638, and John, Sen., d. about 1658.

EAMES.—Inventory of Gersham Eames, dated Dec. 10, 1676, by John Warren, John Barnard, and John Nevinson, all of Wat.; two parcels of land in Marlboro, £15.

EATON.—The witnessing of the Will of John Eaton, first of Watertown, afterwards of Dedham, by Rev. John Allin, and Hon. Major Eleazer Lusher, and the taking of his Inventory (Nov. 30, 1638, £392 10s.) by Eleazer Lusher, Henry Chickering, and John Hayward [not Harvard, as in General Reg. IX. p. 38], imply that he held a respectable social position. He had a son Jacob, b. in Dedham, 1642, who must have d. early.

Mar. 5, 1705–6, Samuel Livermore, maltster, Daniel Livermore, potter, and Rebecca Livermore (wid. of Jonathan), for £80, sold to Joshua Eaton, of Reading, 5 acres in Wat. (Waltham), bounded S. by Charles River; E. by Isaac Mixer, Jr.; W. by Abraham Gale; N. by Sudbury Road, with a tan-yard, &c., on the same. Also 6 acres, bounded E. by abovesaid 5 A.; W. by wid. Sarah Beers; N. by Sud. Road; E. by Ab. Gale. Joshua Eaton was a tanner, and carried on the business after he settled in Worcester. He afterwards moved to Spencer, where his wife, Lydia, d. June 5, 1760, aged 73; and he d. there Feb. 26, 1767, aged 84. He was Assessor of Wat., 1714.

p. 203. Joshua Eaton, Jr., his only son, who lived to maturity, grad. Harv. Coll., 1735, studied law with Judge Edmund Trowbridge, and in 1737, commenced the practice of law in Worcester, with very fair reputation and prospects. In 1740, he is said to have received deep religious impressions from the preaching of Rev. George Whitefield, and he became an enthusiastic supporter of him. About 1743, he began to preach as a candidate in Spencer, where he was ordained Nov. 7, 1744, as the first pastor. He m., Dec. 26, 1739, Sarah Elliot, sister of John Elliot, Esq., of New Haven, resident of Spencer, from about 1760 to 1770, the father of Rev. Richard Rosewell Elliot, of Watertown. She d. Oct. 28, 1770, and he d. Ap. 2, 1772, aged 59, in the 28th of his ministry. His successor in the ministry was Rev. Joseph Pope. [See Thomas Hammond 144, in Part II.] Chil.,

1. *John*, b. May 19, 1741; d. July 11, 1754.
2. *Sarah*, b. May 12; d. Oct., 1744.
3. *Sarah*, b. Oct. 11, 1745; m., May 3, 1772, *Dr. William Frink*, of Spencer, son of Rev. Thomas Frink, the first minister of Rutland. 4 chil.
4. *Mary*, b. Oct. 1, 1747; d. July 2, 1754.
5. *Joshua*, b. Jan. 2, 1749; grad. Harv. Coll., 1773.
6. *Samuel*, b. Mar. 14, 1752; d. Jan. 21, 1754.
7. *John Elliot*, b. Feb. 9, 1756; grad. Harv. Coll., 1777, M.M.S.S.; a physician of Dudley; d. 1812.

[See Draper's Hist. of Spencer, pp. 87–90, and 138.]

- EDDY.**—[1.] For 1695, read 1595. [See Winthrop I., p. 101; General Reg. viii. pp. 201, &c.]
- [2.] Dec. 16, 1684, Samuel Pearce signed a petition in behalf of Thomas Orton. It was probably his wife, Mary Orton, who was admitted to Charlestown Church, Ap. 12, 1650. Sept. 1, 1657, the selectment employed Thomas Orton, "to look about the platform of the meeting-house." Thomas Orton, had wood and common land assigned to him in Charlestown, in 1658.
- [3.] John Marion, of Camb., adm. freeman Oct. 15, 1670. John Marion, Sen., of Boston, was a grand juror Aug., 1689; selectman, 1691, and assessor, 1694. John Marion, Jr., selectman, of Boston, 1698 and 1700. Are the Mareans, of Newton, of this family? The orthography of the name is various in the Boston records.
- [4.] Pilgrim Eddy, m. (1st), in Boston, Ap. 22, 1656, William Baker. She m. (2d), — Steadman, before 1678. [Order of her marriages not clear.]
- [5.] Inventory of John Eddy, dated Sept. 7, 1694. House and $\frac{1}{2}$ acre, £20, total £54. 17s.
- [6.] The Will of Samuel Eddy, mentions wife Sarah, sons Samuel and Benjamin; drs. Sarah Coolidge, Deliverance Eddy, Elizabeth Allen, Ruth Stone, and Johannah Eddy. His inventory of real estate, dated Dec. 18, 1711. House and 30 acres, £150; 7 A. near the "Old Mill" in Wat., £50; 12 acres in lieu of township, £12; farm of 80 acres, £60. Total £272. In 1684, he had been a drummer, whom the town refused to pay.
- [7-1.] (2) Mercy, wife of John Eddy, d. in Oxford, Ap. 23, 1747.
- [7-7.] BENJAMIN EDDY, a tailor, of Newton, son of Samuel and Elizabeth, of Wat., m., in 1733, ELIZABETH TRUESDALE, b. Mar. 12, 1709, dr. of Samuel, Jr., and Elizabeth (Hammond) Truesdale, of Newton, and gr. dr. of Samuel, Sen., and Mary (Jackson) T., of Newton. She d. 1751, and he m. (2d), 1753, HANNAH DAY. He moved to Royalston, where he d. 1798, aged 91. [See Hist. of Newton, p. 273.] Chil.,
1. TABITHA, b. Aug. 27, 1734; d. 1736.
 2. ELIZABETH, b. Mar. 6, 1736; d. 1737.
 3. TABITHA, b. July 19, 1738; m. W. BLACKINGTON, of Needham.
 4. BENJAMIN, b. Oct. 21, 1739; a soldier, in the Revolution, 36 months; m., Dec., 1760, SARAH HOLLAND. Chil.,
 1. Elizabeth, b. Ap. 29, 1761; m., 1781, *Elisha Cheney*.
 2. Hannah, b. Dec. 23, 1762.
 3. Benjamin, b. Sept. 13, 1764; m., Dec., 1785, *Zelida Pierce*. He m. (2d), 1821, *Mary Stone*, of Rindge. He m. (3d), in 1827, wid. *Martha Jackson*. He d. 1852, aged 88; 3d wife, d. Oct. 1846. Chil.,
 1. Polly, b. May 25, 1786; d. 1788.
 2. Benjamin, b. July 1, 1787; m. Esther Capron, of Royalston, and had, 1. Benjamin. 2. Otis A. 3. Nelson. 4. George. 5. John; and six daughters.
 3. Zelida, b. May 7, 1791; m., in 1821, Luke Hayward, and d. 1835.
 4. John, b. Feb. 11, 1793; m. Ann Wadsworth.
 5. Alexander Shepard, b. June 29, 1797; d. 1820. 6. Mary Ann, b. June 20, 1805.
 4. *Mehitable*, b. Ap. 9, 1767; m., 1792, *William Foster*, of Boston.
 5. *Abraham*, b. Sept. 28, 1768.
 6. *Abigail*, b. Dec. 4, 1770; m., in 1791, *George Brimmer*, of Brookline.
 7. *Sarah*, b. Sept. 25, 1772; d. 1838. 8. *Ann*, b. July 26, 1776; d. 1838
 9. *Lucretia*, b. Feb. 3, 1779; d. 1809. 10. *Sukey*, b. Feb. 27, 1781.
 11. *Samuel*, b. Mar. 4, 1784.
 5. HANNAH, b. July 3, 1741. 6. SAMUEL, b. Ap. 29, 1744.
 7. JOHN, b. Sept. 25, 1745. 8. WARD, b. Feb. 5, 1748.
- Feb. 9, 1703-4, John Marion, Sen., of Boston, cordwainer, and wife Sarah, dr. of John Eddy; Ruth, wid. of Ezekiel Gardner, of Boston, dr. of John Eddy; Pilgrim Baker, formerly Pilgrim Steadman, wid., dr. of John Eddy; Samuel Pearce, of Boston, and Mary his wife, dr. of Mary Orton, dr. of John Eddy; Nathaniel Baker, of Boston, baker, only son of said Pilgrim; and Samuel Gardner, of Boston, tailor, eldest son of said Ruth Gardner, for £28, sell to Alexander Miller, of Boston, carter, land granted to John Eddy, May 10, 1643, 123 acres, the 93d lot, bounded E. by Francis Smith's grant; W. by John Barnard; S. by Land of Contention; N. by John Knowles, and Caleb Church; the said land Willed Jan. 11, 1677-8, to 4 drs. Mary Orton, Sarah Marion, Pilgrim Steadman, and Ruth Gardner, now called 100 acres, more or less in Nonesuch Plain. Signed by John and Isaac Marion, exc'rs of their father, and for the others. Mar. 26, 1707, Alexander Miller, assigned the abovesaid land to Francis Fulham.

- p. 204. **EDES.**—Daniel Edes, of Charlestown, m., in Lex., Ap. 23, 1759, Katherine Mason [Mason, †18], dr. Mary, b. in Lex., May 24, 1766.

EDWARDS.—John Edwards, sold a tenement in Watertown, to John Flemming, which he (J. F.) sold to John Coolidge, about 1655. A dwelling and 4 acres, sold by John Page to Joseph Child, in Feb., 1652-3, was bounded on the E. by "Mr. Edwards' land." [Lands and localities, sometimes retained the name of the first proprietor after his removal or sale.] — Edwards, of Watertown, had son Abraham, bap. in First Church, of Salem, Aug. 12, 1637. It is probable that this John Edwards, of Wat., was one of the early settlers of Wethersfield, Conn. The Gen. Court ordered, Sept. 27, 1642, that the house, land, and goods of John Edwards, should be Harman Garret's and his heirs, according to appraisement.

"Esther Edwards, daughter of Rev. Mr. Edwards, of Windsor," dwelling with me, says Rev. W. Williams, of Weston, was admitted to Weston Church, Aug. 31, 1718. She was a daughter of Rev. Timothy Edwards, of East Windsor, Conn., and a sister of President Jonathan Edwards, Sen. Her father, and Rev. Mr. Williams, of Weston, both married daughters of Rev. Solomon Stoddard, of Northampton. She was named for her grandmother, Esther (Warham) Stoddard, and was a great-grand-dr. of Rev. John Warham.

EIRE.—Dr. Simon Eire, was selectman of Wat., 1636-43, 7 years. In May, 1643, the General Court appointed him a Commissioner, for Watertown—to end small causes. In Dec., 1641, he was appointed clerk of writs for Watertown. Oct. 1, 1645, "Mr. Simon Eyres, being formerly choeen clerk of the writs for Watertown, and his implements [? employments] being generally at Boston, upon the desire of the town, John Sherman is appointed clerk in his room." [Colonial Record.] This shows about the date of his settlement in Boston. He d. in Boston, Nov. 10, 1658. Inventory by John Clarke, Rd. Parker, and Theodore Atkinson, £577 5s. His Will, dated July 5, 1658, proved Mar. 4, 1658-9 (witnessed by Richard Parker, and Theodore Atkinson; Wm. Hubbard, Jr., of Ipswich, and James Penn, of Boston, ex'rs.), mentions wife, Martha; two youngest children [by his 2d wife], Maria and John; eldest son Thomas, and dr. Dorothy, "the rest of my children having had their portions." To Thomas, he bequeathed "the 200 acres, I am to have laid out at Watertown, for a farm, with the 17 acres of remote meadow, and the 16 acres called Seeley's lot [the homestall of Robert Seeley], lying in Watertown, to make up his double portion." To his youngest son, John, he bequeathed "all my book manuscripts, mortars, scales and weights, stills, pots and glasses." To wife, during her life, he gave his house, garden, &c., in Boston, and his farm in Watertown, with the houses, barn, orchard, &c. (then occupied by Joseph Tainter); after her decease, to be equally divided between Maria and John. [See his Will, in Geneal. Reg. ix, p. 39.] His son John was mem. Art. Co., 1682, of the Council of Safety in 1689; and d. June 17, 1700. John "Eyre" (probably first son), grad. Harv. Coll., 1718, A.M.

Simon Eire, Jr., m. Lydia, dr. of Dr. Comfort Starr. He d. Aug. 10, 1653, leaving one child, Simon. Inventory, dated Aug. 19, 1653, £120 8s. His wife, Lydia, being already deceased, the grandfather, Dr. Comfort Starr, was appointed guardian of the child, Jan. 1653-4.

Hannah Eyre, witnessed a deed in Wat., July 25, 1684. [Mid. Deeds, Vol. ix. 107.]

ESSEX.—Richard Essex and wife, moved from Boston to Wat., in Aug., 1719.

- p. 205. **ESTABROOK.**—[6.] Daniel Estabrook, probably moved to Weston, in 1704. May 15, 1704, Ebenezer Page [12.], for £80, sold to Daniel Estabrook, of Camb. Farms (Lex.), 76 acres farm lands (Weston), in the 9th division, 3d squadron, bounded W. by land granted to John Sherman (? Freeman), now in possession of Capt. Beers' heirs; E. by Saltonstall's heirs; N. by land of John Finch, now in possession of William Bond; S. by land of Mr. Phillips' heirs. Also, 52 acres swamp, in 3d squadron, being all the upland, except 142 A., granted Mr. Eires, now in possession of Joseph Tainter's heirs; bounded N. and S. by squadron lines; E. by Mr. Phillips' heirs; W. by the above Eire Farm. Also, 6 A. of meadow, formerly Lieut. Hammond's; bounded N. and W. by the above 52 acres; S.E. by John Cutting; E. by Nicholas

Cady; with all right in the Nonesuch. Oct. 21, 1704, Daniel Estabrook, for £11 5s. bought of John Woodward, of Newton, Thomas Fisher, of Dedham, and wid. Mary Waite, of Wat., 5 A. meadow on Stoney Brook, 42d lot, formerly granted to Richard Woodward. June 28, 1709, Daniel Estabrook, bought of Thomas Waight, of Wat., and wife Sarah, 8 A. of meadow, bounded W. and N. by Dea. Wm. Bond; E. by John Cutter; S. by D. E.
 [11-2.] Hannah Estabrook m., Ap. 6, 1785, Ebenezer Lawrence. [J. Lawrence, 244, in Part II.]

p. 206. **EVANS.**—Samuel Evans and wife Elizabeth o. c., and wife bap. Ap. 6, 1701.

EVELETH.—Mr. Eveleth adm. f. c. Sept. 24, 1699, and son Francis bap. by Mr. Angier, June 29, 1701.

FAIRBANKS.—Feb. 17, 1695-6, Jonas Fairbanks, of Wat., sold to brother Jabez, of Lancaster, land in L., formerly of father Jabez.

FARNSWORTH.—Peter Farnsworth moved from Groton to Wat., in Jan. 1767.

FARR.—Feb. 25, 1652, Barnabas ffar, and wife Grace, of Boston, sold to Richard Beers, of Wat., a homestall of 6 A., and five other lots in Wat., formerly granted to John Firman, d., and by his heirs sold to Barnabas Farr. John Farr, wife, and two chil., moved from Boston to Wat., in July, 1733.

FAULKNER.—For Feb. 27, read Feb. 29. Francis Faulkner was selectman of Wat. 1797, 99, 1800. [For the pedigree of this family, see Shattuck's History of Concord, p. 292.]

FAY.—For Raybold, read Reynold. Elizabeth Wellington [14.] m. John Fay. Wid. Caty Fay d. in Wat., Aug. 21, 1823, aged 60.

FEAKE.—Robert Feake, of Wat., m. a "daughter-in-law" of Gov. John Winthrop. He sold his homestall in Wat., a house and 10 acres, to Thomas Bright, who, for £60, sold it, Dec. 17, 1640, to Col. William Rainborow. Sept. 4, 1632, Robert Feake was chosen Lieutenant under Capt. Patrick. He was one of the committee that reported Dorchester bounds, Mar. 28, 1636. He was appointed, May 25, 1636, one of those "deputed to keep the Courts" for those towns, which afterwards became the Co. of Middlesex. Henry Feake (whether a relative of Lieut. Robert not ascertained) was adm. freeman May 14, 1634, and magistrate of Newtown, L. I., 1656 and 57.

p. 207. **FELTON.**—Benjamin Felton d. in Wat., Aug. 15, 1765, aged 53, and his wid. (?) m. Samuel Livermore, Esq. [156.] He was a constable in 1762, and, at the time of his decease, was guardian of Jonas Coolidge [79.] His son Benjamin d. July 15, 1754, and his dr. Lucy d. July 26, 1766.

FERGERSON.—John "Fogerson" and family moved from Wat. to Camb. in Mar. 1733.

FESSENDEN.—Benjamin Fessenden, b. Jan. 30, 1701 [son of Nicholas and Margaret (Cheeney) Fessenden, of Camb., and younger brother of Nicholas, Jr., who m. Sarah, wid. of Stephen Cooledge [26, in Part II.]] grad. Harv. Coll. 1718, was engaged, May, 1718, to keep school in Wat., and continued there until July 22, 1722, when he accepted a call to settle in Sandwich, where he was ordained Sept. 12, 1722.

BENJAMIN FESSENDEN, b. Jan. 9, 1733-4, son of Thomas and Abigail (Locke) F., of Lex., by his 2d wife, BARBARA CALDER [see family of Daniel Lawrence, son of George Lawrence, in Part II.] had,

1. *Mary*, b. in Milton, Aug. 29, 1761; m. *Benjamin Hurd*, of Charlestown, his 2d wife. [See p. 518.]
2. *Arthur*, b. in M., Dec. 8, 1763; a merchant, of Boston.

3. *Hannah*, bap. in Wat., Aug. 18, 1765; d. of yellow fever in 1802, unm.
4. *Elizabeth*, bap. in Wat., Feb. 27, 1767; m., 1st, *Benjamin Nichols*; m., 2d, *John Vinton*.
5. *Rebecca*, bap. in Wat., Mar. 5, 1769; m., in 1803, *Archibald Anderson*, of Boston.
6. *George*, bap. in Wat., Aug. 12, 1770; a blacksmith, of Wat., Boston, and Milton.
7. *Thomas*, bap. in Wat., Ap. 26, 1772; m. *Olive Parsons*, of Kittery, Me. [For more information, see Locke Family, Index.]

Jonathan Fessenden had dr. Sarah, bap. in Wat., Jan. 22, 1743-4. Jonathan Fessenden had son Martin, bap. in Camb. village (Brighton), Feb. 14, 1768, and son Thomas, bap. May 10, 1772, both by Mr. Storer.

FIELD.—[1.] For [Bigelow, †154] read [Bigelow, 157.] [3.] For Braintree, read Barnstable, Mass.

FINCH.—Daniel Finch, supposed to have come over in the same ship with Sir Richard Saltonstall [Winthrop, II. p. 340], and to have accompanied him to Watertown, was adm. freeman May 18, 1631. He was a member of a jury of inquest, appointed May 3, 1631, half of whom were Watertown men, and he was appointed, Oct. 1631, one of the commissioners for settling the estate of Mr. Crispe, of Watertown. He was one of the colony which first planted Pyquag (Wethersfield), and was appointed the first constable of that plantation, at the first Court held in the colony, Ap. 26, 1636. He was one of the original purchasers of Stamford, Conn., Oct. 30, 1640. John Finch was a proprietor of Stamford in 1641. [See Hinman, p. 232.]

p. 208. **FISKE.**

Mr. Somerby, having recently visited and examined the Parish Registers in the County of Suffolk, where the Fiskes are known to have resided at an early date, says, "I found sufficient to justify the belief, that Nathan Fiske [of Watertown] was the eighth in descent from the first Simon Fiske, of Laxfield, through Robert, of St. James. South Elmsham, who was his (Nathan's) great grandfather. [The other Fiskes of New England are, it is believed, all of the same lineage.] This Simon Fiske was lord of the manor of Stradhaugh, in Laxfield, in the time of Henry VI., and he bore the following arms, viz., "Checkey Arg. and Gule; upon a pale sable three mullets or. pierced." These arms were confirmed Nov. 16, 1633, to Nicholas Fiske, professor of physick, of Stradhaugh, in the Parish of Laxfield, and at the same time a crest was granted him, "for an ornament." The arms had been borne by his ancestors in the reigns of Henry VI., Edward IV., Richard III., and Henry VII.

Mr. Somerby says, "the family [of Fiskes in Suffolk] is very ancient, and has always been highly respectable." He found nearly fifty Wills of this family, proved in Suffolk, between 1462 and 1635. These searches of Parish and Probate Records, and the copying of them, cannot be prosecuted in England without considerable expense; and it is to be hoped that, among the almost innumerable Fiskes in New England, many of them wealthy and liberally educated, a sufficient purse will be made up, in order to make a thorough investigation.

Joshua and Anthony Fisher, brothers (?), of Dedham, were sons of — Fisher, of Sileham, who m. Mary Fiske, supposed to be a daughter of William and Anne Fiske, of South Elmham, and to be an aunt of Rev. John Fiske, of Chelmsford, Mass.

Martha Fiske, a sister of the Rev. John Fiske, of Chelmsford, and of Wm. of Wenham, m. Capt. Edmund Thompson, son of John and Anne (Hastings) Thompson, of Holkham Co., Norfolk. E. Thompson was a sea-captain, had 4 chil., b. in Salem, viz., Martha, Edmund, Thomas, and Hannah; afterwards returned to England, and resided in Yarmouth, where he had 3 other chil., all d. in infancy.

Anne, the other sister of Rev. John Fiske, m. Francis Chickering, of Dedham, Mass. [See Mass. Hist. Coll. 3d Ser. X. pp. 156-61.]

DAVID FISKE.—[1.] David Fiske, of Wat., "the emigrant," m. Sarah Smith, sister of Benjamin, and a daughter of Edmund Smith, of Wrentham, Co. Suffolk, England.

Thomas Fitch, of Boston, cordwainer, m. Martha, only dr. of David Fiske, Sen., of

Wat. Chil.: 1. Martha, b. Nov. 9, 1656. 2. Mary, b. Feb. 17, 1659. 3. Sarah, b. June 14, 1661. 4. Elizabeth, b. Aug. 2; bap. in 1st Church, Sept. 4, 1664 (father then said to be "of Watertown"). 5. Thomas, b. Feb. 5, 1669. Thomas Fitch was one of "the merchants and traders" of Boston, who petitioned for a bankrupt law, in June, 1701.

- [2.] Ap. 1, 1672, David Fiske, aged about 49, testified, &c., showing that he was born in 1623 or 24. Oct. 6, 1663, the Court allowed him 10s. each for 7 wolf's whelp's heads. His first wife, Lydia, d. Nov. 29, 1654. His dr. Lydia m. Sept. 6, 1681, Nicholas Wyeth, Jr., of Camb., afterwards of Wat. [See Wyeth, p. 669.] He had son Ephraim, b. July 13, d. Sept. 14, 1653. His dr., Hannah Fiske, was bap. Nov. 27, 1659; m., May 3, 1680, Timothy Carter. She d. Jan. 27, 1715-16.
- p. 209. [12.] This was probably the Jonathan Fiske who m., in Lunenburg, July 28, 1738, Jemima Foster, of L. and had Jemima, b. Feb. 8, 1738-9.
- [14.] JAMES PATTERSON m., Oct. 4, 1730, LYDIA FISKE. He moved to Petersham, then to Princetown, where he d. May 4, 1766, and left wid. Lydia, who d. 1776, aged 66. Chil.,
1. Jonathan, b. Nov. 30, 1735; killed by the Indians in the French war, July 20, 1758, in his 17th year.
 2. David, b. May 11, 1739.
 3. Andrew, b. Ap. 14, 1742, of Sud., m., Oct. 21, 1761, Elizabeth Bond [87], of Worcester. Chil.,
 1. Sarah, b. May 15, 1764.
 2. James, b. Feb. 22, 1768. [Barry, p. 356.]
- [19.] See Stone [12.] p. 586.
- [26.] Dr. Robert Fiske d. 1753, or 4. He m., May 26, 1718, Mary Stimson, of Reading.
- [33.] Jonathan Fiske, of Lex., m., Sept. 4, 1755, Abigail Locke, dr. of William and Jemima (Russell) Locke, of Woburn. [See Locke Fam., p. 23.]
-
- p. 210. **JOHN FISKE.**—[1.] For the legacies of Dr. John Clarke, see Mid. Deeds, vol. IX., pp. 42-45.
- [4.] Margaret, d. Jan. 15, 1750, aged 91, unm.
- [8.] See Mellen, Part II.
- [12.] May 23, 1697, John Fiske, and wife Abigail, for £10 10s, sold to John Ward, of Newton, turner, 13½ acres in Newton, probably inherited from her father.
- [19.] He was selectman in 1717.
- [22.] The real estate of Wm. Fiske was assigned to Mary Bridge, wife of Nathaniel Bridge, dr. and only child of said W. Fiske.
- p. 211. [25.] Lieut. John Fiske was selectman in 1731.
- [33.] See N. Fiske 35, and Perry 32. It is not clearly ascertained whom these two Hannah Fiskes married; but probably this one [33] m. Nathan Perry.
- [34.] This was probably the John Fiske of Waltham, who belonged to Captain Jonathan Brown's Co. at Lake George, in 1758.
- [49-1.] For Lonazo, read Lorenzo. [49-3.] Horatio Nelson Fiske, and Anna Smith, both of Waltham, m. in 1822
- p. 212. [52.] Mary Fiske m., 1755, Samuel Hammond, of Newton. [T. Hammond, 120, Part II.]
- [53-1.] PHINEAS FISKE, of Waltham, m., Feb. 1, 1785, ABIGAIL STEARNS. [C. Stearns, 122.] She d. 1843. Chil.,
1. Phineas, b. Ap. 29, 1786, a merchant, of Keene, N. H., where he d. 1842. He m. (1st), 1812, Mary Hart, who d. 1820. He m. (2d), Nov. 18, 1824, Isabella Brigham Redington. [See I. Stearns, Ap. VI. [19.]] She d. 1841. Chil.,
 1. Mary, b. 1813; m., 1840, Thomas R. Edwards, Esq., of Keene. Grad. Dart. Coll. 1813, Counsellor at Law, and Pres. Cheshire R.R. Co. 7 chil.
 2. Julia, b. 1815; m. 1840, William Dinsmoor, merchant, of Keene.
 3. Warren, b. 1816, d. 1834.
 4. Phinehas, b. 1819; m., 1843, Helen Clapp, of Boston.
(By 2d wife.)
 5. Francis Skinner, b. Nov. 9, 1825; grad. Dart. Coll. 1843; LL.B. Harv. Coll. 1846; Colonel, and a lawyer of Keene; has travelled much in Europe, and has circumnavigated the globe.
 2. Priscilla, b. Sept. 17, 1787; m. in Lincoln, Sept. 16, 1807, Elisha Hagar [174.]
 3. Abigail, b. 1790; m., 1815, Jonas Smith, of Weston.
- [53-3.] Jonathan Fiske m. — Baker.

- [60.] Abigail Fiske m., Sept. 16, 1794, Rev. Solomon Adams, of Middleton; grad. Harv. Coll. 1788. She d. 1842.
- [69.] Dea. Samuel Fiske was selectman of Wat. 1751, 53, 54, 55, 56, 57, 58. Was he or his Samuel a Justice of the Peace?
- [73.] He was probably the Samuel Fiske of Wat. who belonged to Capt. Jonathan Brown's Co. at Lake George in 1758. He was selectman of Waltham 1771 and 72.
- p. 213. [84.] For Fowles, read Fowle.
- [90.] For E. Cambridge, read Cambridge.
- [92½] 6½. Sarah, bap. Oct. 28, 1750.

- p. 214. **NATHAN FISKE.**—[3.] This John Fiske, brother of David, was witness in Court, June 11, 1679, said to be aged 30.
- [6.] Admin. on estate of Lieut. Nathan Fiske (who was selectman 1684, 88, 91), was granted to wid. Elizabeth, Dec. 10, 1694. Inventory by Wm. Bond, Sen., Samuel Jennison, Sen., and Nathaniel Barsham, dated Nov. 27, 1694. House and 22 A., on both sides of the highway, £45; 6 acres in Newton, £9; 12 acres about Prospect Hill, £6; 7 acres in Thatcher's Meadow, £5; about 250 acres farm land, £15. The 220 A. he bought of Thomas Underwood, in 1673, was bounded N.W. by Anthony Peirce; S.E. by Henry Bright or Martin Underwood; S.W. by Mrs. Phillips and John Whitney; N.E. by Henry Bright, B. Crispe, and — Sternes, 19th lot, 5th div. An agreement of his children, dated Nov. 23, 1696, was signed by Nathan Fiske, David Fiske, the guardian of William Fiske, James Ball, for Elizabeth, his wife, Edward Parke, for Martha, his wife, John Mixer, for Abigail, his wife, and Susanna Fiske.
- [10.] Susanna Fiske d. in Wat., Ap. 28, 1752.
- [12.] After the d. of Lieut. N. F., his brother David was guardian of his son William.
- [19.] The first child of Nathaniel and Hannah (A.) F., was Nathaniel, b. Nov. 11, 1706.
- [19-1.] ASA FISKE, b. in Wat., Feb. 22, 1708; m., Jan. 30, 1734-5, LOIS LELAND, b. 1714, eldest dr. of Timothy and Elizabeth (Learned) Leland, and settled in Holliston. [See Learned, 26, and Leland Magazine, p. 26.] His Will, dated Nov. 6, 1770, proved Jan. 8, 1781, mentions wife Lois; sons, Abel, Aaron, Asa, Abner, and drs., Lydia, Huldah, and Lois. The Will of his wid. Lois, dated Mar. 3, 1775, lodged Feb. 25, 1801, mentions the same sons, and drs. Huldah Clafin and Lois Marsh. Chil.,
1. *Lydia*, b. 1738; m. — *Burbank*, a farmer, of Holliston.
 2. *Huldah*, b. 1740; m., *Caleb Clafin*, a farmer, of Hopkinton.
 3. *Abel*, b. 1743; a farmer, of Medway; m., *Mehitabel Riz*.
 4. *Asa*, b. 1746; d. 1830; a farmer, of Holliston; m. *Mercy Jones*.
 5. *Aaron*, b. 1748; a farmer, of Chesterfield, N. H.; m. — *Matcalf*.
 6. *Lois*, b. 1751; m. *Amariah Marsh*, of Pawtucket, R. I.
 7. *Abner*, b. 1754; a farmer, of Lee, Oneida Co., N. Y.; m. *Molly Grout*.
- [19-3.] Moses, b. Jan. 29, 1713. [19-4.] Lydia, b. 1715; d. 1717. A 2d Lydia, b. Oct. 5, 1718.
- p. 215. [23.] Lydia Fiske. [See Warren, 56, and Harrington, 111.]
- [27.] Dea. Nathan Fiske, was selectman, 1711, 14, 17, 19, 20, 22, 23, 24, 26, 27; Treasurer, 1720, 22, 23; Town Clerk, 1724, 28, 32, 39. He was elected deacon, as early as 1717. He d. Jan. 26, 1741-2, and his wid. Hannah, d. Oct. 4, 1750.
- [28.] Sarah was b. 1697. The 2d child, Elizabeth, d. aged 7 years.
- [31.] Lieut. HENRY FISKE, an original proprietor, of New Medfield (Sturbridge); m., in Wat., Jan. 10, 1737-8, MARY STONE. [Stone, 25, Part II.] He d. in Sturbridge, Mar. 1, 1790, aged 83, and his wid. d. June 2, 1805, aged 88. Chil.,
1. *Mary*, b. Jan. 29, 1738; d. Aug. 31, 1777; m. *John Fay*, who d., killed in battle, Aug. 16, 1777.
 2. *Daniel*, b. and d. Jan., 1740. 3. *Henry* (? twin), d. Nov., 1740.
 4. *Susan*, b. Sept. 19, 1741; d. Dec. 26, 1812; m. *Stephen Fay*, of Hardwick.
 5. *Armilla*, b. Aug. 24, 1743; d. Sept. 13, 1754.
 6. *Henry*, b. Aug. 16, 1745; m., May 5, 1774, his cousin, *Sarah Fiske*. He d. Dec. 10, 1815.
 7. *Anna*, b. June 11, 1747; m. *Silas Corbin*, of Woodstock.
 8. *Samuel*, b. Mar. 30, 1749; d. Sept. 19, 1754.
 9. *Thomas*, b. Mar. 2, 1751; d. Sept. 16, 1754.
 10. *Ruth*, b. Feb. 17, 1754; d. Sept. 29, 1754.
 11. *Simeon*, b. Mar. 26, 1755; d. Feb. 28, 1840.
 12. *Bulah*, b. Ap. 26, 1757; m. *Solomon Jones*, of Brimfield.

13. *David*, b. Dec. 19, 1759; d. Aug. 19, 1817.
14. *Eunice*, b. Nov. 21, 1761; m. *Joshua Woodbury*, of Sutton.
- [32.] Dea. DANIEL FISKE, then of Sturbridge, m., in Wat., Mar. 31, 1743, DELIVERANCE BROWN. [Brown, 40.] She d. in Sturbridge, July, 1758; and he m. (2d), Feb. 19, 1760, JEMIMA SHAW, of Sturbridge. He d. Mar. 15, 1778, of small-pox, taken at Boston, when he was there as Rep. of Sturbridge. His wid. m., Dec. 17, 1799, Dea. SAMUEL GREEN, of Leicester, where she d. July 2, 1810, and was buried in Sturbridge, near the grave of her former husband. Chil.,
1. *Anne*, b. May 9, 1744; d. Aug. 11, 1746.
 2. *Sarah*, b. Aug. 1, 1746; m., May 5, 1774, her cousin, *Henry Fiske*, Jr. She d. Dec. 11, 1815, the next day after the d. of her husband, and they were both buried the same day.
 3. *Daniel*, b. May 12, 1748.
 4. *Joshua*, b. Aug. 26, 1750, d. soon.
 5. *Nathan*, b. June 20, 1755, d. young.
 6. *Deliverance*, b. July 31, 1757; m., 1778, *Silas Marsh*, of Sturbridge.
(By 2d wife, *Jemima*.)
 7. *Jemima*, b. Nov. 22, 1760; m. *Joshua Harding*, Jr., of Sturbridge, one of whose chil., Daniel Fiske Harding, grad. Brown Univ., 1809, and settled, as a lawyer, in Union, Me.
 8. *Nathan*, b. Ap. 4, 1762; m. *Abigail Lyon*. He is a U. S. pensioner.
 9. *Lydia* (twin), b. Ap. 4, 1762; m., Feb. 6, 1783, *Oliver Plimpton*, a corporal in the Revolution, and a U. S. pensioner. He d. Dec. 20, 1851, aged 89 yrs. 8½ m.
 10. *Susannah*, b. Feb. 6, 1764; m., 1784, Capt. *Samuel Newell*, a soldier of the Revolution (son of Dea. Isaac N.), 6 sons and 2 drs. Their dr. *Dolly*, b. Dec. 25, 1788, m. Hon. William Larned Marcy. Mr. Marcy was b. Dec. 12, 1786, son of Jedediah Marcy, of Sturbridge, and grad. Brown Univ., 1808, L.L.D. 1833. He has held numerous highly responsible offices; among others, those of U. S. Sec. of War, and Sec. of State. He is a descendant of William Larned, of Killingby, Conn. [See Learned, 14.]
 11. *Hannah*, b. Sept. 24, 1765; m., Mar. 27, 1789, *Samuel Grous*, of Monson, Mass.
 12. *Rebekah*, b. Mar. 20, 1768; m., 1795, *John Streeter*, and d. in Cambridge, N. Y.
 13. *Miriam*, b. Jan. 30, 1770; m. *Salmon Hebard*.
 14. *Kezia*, b. Oct. 25, 1771; m., Sept. 29, 1792, *Gershom Plimpton*, Esq. She d. Oct. 8, 1808. 5 sons and 2 drs. Their eldest son, *Moses*, b. Oct. 17, 1793, now (1853) of Boston, has furnished most of the preceding record of the Fiskes, of Sturbridge.
 15. *Samuel*, b. Dec. 30, 1773; m. *Sally Lyon*.
 16. *Lois*, b. Feb. 8, 1776; m., July 29, 1795, *Asa Bacon*, of Charlton. She d. Oct. 21, 1797, s. p.
- [33.] Samuel Fiske, was a Justice of the peace, in Wat.
- [35.] Hannah, wid. of William Smith, d. Sept. 2, 1813, æt. 94.
- [36.] John Fiske, d. in Sherburne, May 8, 1730.
- [37.] JOHN, b. May 8, 1709; of Sherburne; m., Sept. 21, 1731, ABIGAIL BARCOCK. He d. Jan. 9, 1754, and his wid. d. Mar. 7, 1761. Chil.,
1. *David*, b. Ap. 16, 1732.
 2. *Hannah*, b. Jan. 24, 1734.
 3. *Amos*.
 4. *John*, b. Mar. 16, 1738.
 5. *Joel*, b. Ap. 22, 1740.
 6. *Jonas*, b. Dec. 4, 1742.
 7. *Martha*, b. Jan. 5, 1749; d. Nov. 19, 1750.
- [38.] Lydia, b. Jan. 14. [40.] Daniel, b. Ap. 7. Lydia, b. Aug. 4. Peter, b. Mar. 12.
- [45.] Nathan Fiske, was a schoolmaster, in Weston, previous to Mar. —, 1758. He was the first pastor of the 3d Parish of Brookfield, ordained May 24, 1758. [See History of Brookfield, by Rev. Joseph J. Foot, pp. 13 and 59.]
- [51.] Hepzibah, d. unm.
- p. 216. [52.] Josiah Fiske, m. Sarah Lawrence, b. June 20, 1708, dr. of John and Anne (Tarball) Lawrence, of Lex. [See John Lawrence, 56, in Part II.]
- [53.] David, d. Feb. 1, 1766.
- [54.] Strike out, chil., and all after it to [71.] See J. Fiske. [53-1. Part II.]
- [71.] Sarah, m., in Pepperill, Ap. 14, 1756, Simon Gilson. 10 children.
- [72.] It is doubtful whether this is the Amos Fiske, who m. Mary Whitney.
- [73.] Strike out all after 1742, and insert the following: m., in Pepperill, Ap. 22, 1766, ELIZABETH VARNUM (?), b. Mar., 1742, dr. of Jonas and Lydia (Boyden) Varnum, of Groton. Chil.,
1. *Mary*, b. Mar. 13, 1767.
 2. *Nathan*, b. Jan. 3, 1769.
 3. *Micah*, b. June 11, 1771; d. Aug. 10, 1772.
 4. *Walter*, b. June 17, 1773.

5. *Micah*, b. Jan. 9, 1775. 6. *Daniel*, b. Mar. 9, 1777.
 7. *Betty*, b. Feb. 17, 1779. 8. *Sarah*, b. July 1, 1781.
 9. *Josiah*, b. Jan. 3, 1783. 10. *Varnum*, b. Sept. 13, 1786.
 [74.] *Anna*, b. Dec. 16, 1747; m., Mar. 3, 1768, Dr. Ephraim Lawrence, of Pepperill. She d. June 12, 1774, aged 27. 2 chil. [See John Lawrence, 268, in Part II.]
 [74½.] *Abel*, b. May 28, 1752; grad. Harv. Coll., 1774, ordained in Wilton, N. H., Nov. 18, 1778, successor of Rev. Jonathan Livermore [Livermore, 211]; d. Ap. 26, 1802. [See Farrar Family, p. 40, and N. H. Hist. Coll. I., p. 67.]
 [75.] The Will of Isaac Fiske, of Fram., dated Aug. 24, 1789, mentions wife Hannah; sons John, Richard, Daniel, and Moses; James and Polly, heirs of son Isaac; drs. Hannah Everett, and Lydia Nurse.
 [76.] *Isaac*, b. 1736.
 p. 217. [102.] For George, read George B.
 [106½.] *Daniel*, b. Mar. 20, 1778; d. in Norfolk, Va., Mar. 23, 1800. *Nancy*, b. July 6, 1780.
 [107.] *Richard*, b. Jan. 29, 1783. [109.] *Josiah*, b. Feb. 22, 1785.
 [109½.] *David*, son of Richard, b. Feb. 16, 1791; d. Nov. 24, 1817. By his Will, left to the Baptist Church, in Fram., \$570, which he had saved of his earnings as a teacher in that town.
 [110.] *Daniel*, b. 1751. His wife *Sukey* d. 1798, aged 45, and he m. (2d), in 1800, *Alice Davis*, of Oxford.
 p. 218. [120.] For [3-7], read [3-m].
 p. 219. [136.] After Flagg, insert [141-2].
 [138.] For Nov. 7, read Nov. 2. For his m., see Hobbs, 4-7.
 [140.] For [Jones, 55], read [Jones, 71].
 [145.] After Sanderson, insert [Sanderson, 56-6, in Part II.]
 [146.] For *Lydia Fiske*, read *Lydia Travers*. [See Travers.] They moved to Sturbridge.
 [150.] Strike out, this *Abraham* and his family, and see 49, p. 214.

FITCH.—[See David Fiske, [1.] in Part II., p. 758.]

FLAGG.—This orthography of the name has been adopted in the text, because it has become the prevalent, almost the universal usage, for the last few generations. There is, however, very little doubt but that it is erroneous, and that the correct orthography is Flegg. In the first place, the name Flagg is not found in *Burke's Encyclopædia of Heraldry*, which is a pretty good dictionary of well-known early English names; but Flegg is found there, with a coat of arms, with some variations, as Fleggh and Flegh. In the second place, in the early records of the town, and of the county, for eighty years or more, the name is, almost without exception, written Flegg, with some variations, always retaining the *e*, as Fleg, Flege, Flegge, flegg, &c. Finally, we have the autograph of Thomas Flegg, Jr., a facsimile of which is here inserted, which is written with an *e*. The initial ff, for F, was not unusual at that period.

- [1.] For 1643, read 1641. *Thomas Flagg*, Sen., continued to be selectman, 1681, 85, and 87. He was released from training Ap. 165-, by paying the Co. 5s. per annum. He was fully released therefrom by the Court, Ap. 5, 1681, when his eldest son was 40 years old. His Will, proved Feb. 16, 1697-8, mentions only a part of his children, viz., sons *Thomas*, *Michael*, *Allen*, and *Benjamin*, and dr. *Rebecca Cooke* [son *Gershom* was already deceased.] *William Flagg*, killed by Indians at Lancaster, Aug. 22, 1675, was probably another son, b. about 1648, and, being dead, not mentioned. The Will of his wid., *Mary*, dated Dec. 30, 1702, mentions only a part of her children, viz., *Mary Bigelow*, *Elizabeth Bigelow*, *Rebecca Cook*, and son *Benjamin*; son *Samuel Bigelow*, Exr.
 p. 220. 2½. *Bartholomew Flagg* belonged to Capt. *Samuel Moseley's* Company in Dec. 1675. [Geneal. Reg. viii., p. 241.]
 [4.] *Gershom*, b. in Wat., Ap. 16, 1641, the eldest child. In the town record this is written *Fleet*.
 [6.] *Eliezer Flagg*, of Concord, adm. freeman Mar. 22, 1689-90.
 [12.] Admin. on estate of *John Flagg* granted to his wid., *Mary*, Mar. 22, 1696-7. Inventory dated Mar. 1, 1696-7, viz., house, &c., £60; 14 acres by *Chester Brook*, £7; 12 acres by *Edward Sanders* [Sanderson] £5; and 12 A. outland.

- †22. 1 (11.) Lieut. GERSHOM FLAGG, b. in Wat., Ap. 16, 1641, eldest child of Thomas and Mary; adm. freeman May 27, 1676; settled in Woburn, and there m., Ap. 15, 1668, HANNAH LEPPINGWELL, b. in Woburn, Jan. 6, 1647-8, dr. of Mitchell Leppingwell. He was killed by Indians at Lamprey River, July 6, 1690, and his wid. Hannah m. (2d), Dec. 10, 1696, Ensign Israel Walker, whose first wife d. Mar. 9, 1694.
-
- 2 1. GERSHOM, b. Mar. 10, 1668-9; of Woburn; m. HANNAH ——. She d. Jan. 4, 1740-1. Chil.,
- 3 1. *Elizabeth*, b. May 22, 1696.
2. *Gershom*, b. Nov. 22, 1698, d. July 11, 1700.
- 4 3. *Zechariah*, b. June 20, 1700; m., Jan. 2, 1733, *Mary Gardner*, of Charlestown. Chil.,
- 5 1. *Joseph*, b. Feb. 9, 1734. 2. *Zechary*, b. June 17, 1737.
- 7 3. *Mary*, b. Sept. 2, 1739. 4. *Mary*, b. Feb. 24, 1741.
- 9 5. *Samuel*, b. June 23, 1744. 6. *John*, b. Aug. 29, 1746.
- 11 4. *Gershom*, b. Jan. 25, 1701-2; m. *Martha* ——. She d. 1738. He m. 2d, *Bette* ——. Chil.,
- 12 1. *Martha*, b. Mar. 11, 1728-9; m., Oct. 28, 1747, *John Lane*, of Bedford.
- 13 2. *Benjamin*, b. Mar. 3, 1730; m. *Hannah* ——. She was probably the wid. *Hannah Flagg* who d. in Woburn, Dec. 29, 1815, aged 79. Chil.,
- 14 1. *Benjamin*, b. Dec. 23, 1754. 2. *Ebenezer*, b. July 11, 1757.
- 16 3. *Joseph*, b. Ap. 11, 1758. 4. *Joseph*, b. Ap. 28, 1759.
- 18 5. *Hiram*, b. Nov. 16, 1761.
- 19 3. *Hannah*, b. July 8, 1731. 4. *Abigail*, b. Dec. 13, 1733.
54. 21 5. *Gershom*, b. Ap. 28, 1735. 6. *Josiah*, b. May 28, 1737.
(By 2d wife, *Bette*.)
- 23 7. *Betty*, b. June 4, 1745.
- 24 5. *Joseph*, d. Sept. 19, 1724. 6. *Benjamin*, d. Ap. 7, 1725.
- 26 2. ELEAZER, b. Aug. 1670; a colonel, and magistrate of Woburn; m., Jan. 17, 1694-5, ESTHER GREEN. He d. July 12, 1726, and his wid., "Madam Esther," d. Sept. 18, 1744, aged 70. Chil.,
- 27 1. *Esther*, b. Oct. 17, 1695.
- 28 2. *Eleazer* (birth not recorded, supposed to be a son) m. *Hannah* ——. He moved to Dunstable about 1732. Chil.,
- 29 1. *Sarah*, b. Oct. 26, 1726. 2. *Eleazer*, b. Aug. 26, 1728.
- 31 3. *Reuben*, b. Mar. 3, 1729-30. 4. *Jonas*, b. May 10, 1731.
- 33 5. *Hannah*, b. Nov. 10, 1732.
- ✓ 34 3. JOHN, b. May 25, 1673. *John Flagg*, a tanner, of Boston, and wife *Abiel*, sold land in Woburn, in 1699.
- 35 4. HANNAH, b. Mar. 12, 1674-5; m., Jan. 9, 1695, HENRY GREEN.
5. THOMAS, b. 22, d. 23, June, 1677.
- 36 6. EBENEZER, b. Dec. 21, 1678; d. July 10, 1746; of Woburn; m., Dec. 25, 1700, ELIZABETH CARTER. Chil.,
- 37 1. *Elizabeth*, b. July 25, 1701; m. (?) Jan. 26, 1721, *Job Brooks*, of Concord. [Brooks, 57, Part II.]
- 38 2. *Mary*, b. Dec. 6, 1702; m., Mar. 24, 1726, *Isaac Baldwin*.
- 39 3. *Ebenezer*, b. Oct. 18, 1704; grad. Harv. Coll. 1725. [See †30, p. 221.]
- 40 4. *John*, b. Sept. 7, 1706; d. June 23, 1724.
- 41 5. *Gershom*, b. July 29, 1708; m., June 11, 1730, *Lydia Waters*. Chil.,
- 42 1. *John*, b. Sept. 13, 1731. 2. *Mary*, b. Ap. 12, 1733.
- 44 3. *Ephraim*, b. Nov. 9, 1735.
- 45 6. *Thomas*, b. Nov. 19, 1710. 7. *Josiah*, b. Nov. 12, 1712.
- 47 8. *Ruth*, b. Oct. 14, 1714. 9. *Hannah*, b. Oct. 1, 1716.
- 49 10. *Abigail*, b. July 20, 1718. 11. *Abigail*, b. June 7, 1722; m., Dec. 18, 1738, *Samuel Esterbrooke*.
- 51 7. ABIGAIL, b. Jan. 9, 1681; (?) m., Dec. 12, 1700, DAVID CUTLER.
- 52 8. MARY, b. Feb. 2, 1682-3.
- 53 9. THOMAS, b. Ap. 19, 1685; (?) settled in Boston; a member of the 2d Church, where he had the following chil. baptized: 1. *Mary*, bap. Mar. 2, 1707; 2. *William*, bap. Nov. 28, 1708; 3. *Esther*, bap. Mar. 18, 1711; 4. *Hannah*, bap. Dec. 7, 1712; 5. *Thomas*, bap. July 3, 1715; 6. *Joseph*, bap. Aug. 4, 1717; 7. *John*, bap. Sept. 7, 1718; 8. *Mary*, bap. May 8, 1720.

10. BENONI, b. and d. Aug. 19, 1687.

22. 54 (V.) Col. JOSIAH FLAGG, of Boston, supposed to be a son of Gershom Flagg, tertius, of Woburn; m., about 1758, ELIZABETH HAWKE, then aged about 17 yrs., dr. of Samuel Hawke, some time of the island of St. Christopher, afterwards of Boston. Chil.,
1. MARY, bap. in Christ Church, Boston, Oct. 26, 1760, d. in Utica, N. Y., about 1841, unm.
 2. ELIZABETH, b. 1761; d. in Providence, R. I., Aug. 12, 1803.
 3. JOSIAH, bap. July 24, 1763, a dentist and musician, of Boston, afterwards of Providence, father of Dr. Josiah F. Flagg, dentist, of Boston, and of Dr. J. F. B. Flagg, dentist, of Philadelphia.
 4. SAMUEL, bap. Jan. 16, 1765.
 5. LUCRETIA, bap. May 18, 1766; m. — CARY, an Englishman.
 6. MARTHA, m. — DICKENS, a merchant, of Providence.
 7. ESTHER, m. — POWERS, of Boston.
 8. GRACE SPEAR WILLIS, b 1770; m., in Boston, June 11, 1789, AARON MANN. He d. Ap. 4, 1834, æt. 82, and his wid. d. Oct. 29, 1843. 7 sons and 2 daughters.

- p. 221. [22.] The Will of Michael Flagg mentions wife Martha; [Had he a third wife, or is this an error for Mary?] sons Earl and Bezaleel, and drs. Mary and Prudence. Inventory dated Nov. 2, 1711; real estate, house, and 17 A., £85. 36 acres in lieu of township, £72.
- [42.] Admin. on estate of Allen Flagg granted Nov. 28, 1711 to his wid Sarah. Inventory dated Nov. 11, 1711. Homestead 34 A. £68. Outland, 24 A., £24.
- [45.] Allen Flagg, Jr., was constable 1735.
- [48.] Josiah Flagg, of Worcester (lineage not ascertained), m., in Lunenburg, Nov. 16, 1769, Hannah Wetherbee. Perhaps he was a son or grandson of Allen F., Jr. [See 46.]
- p. 222. [58.] Jonathan Flagg, and wife Eunice, from Wat., adm. f. c. to Westboro Church, Oct. 1, 1732, and there had 3. Hepzibah, bap. Aug. 26, 1733. 4. Jonathan, bap. Mar. 14, 1736. 5. Joseph, bap. Feb. 18, 1739.
- [63.] The wife of a Joseph Flagg taught school in Wat. 12 weeks from Jan. 1, 1767.
- [68.] Ap. 6, 1735, Wid. Sarah Flagg fined for selling drink without license.
- [74.] Adonijah Flagg moved from Waltham to Wat., Dec. 1739. Had he sons Solomon and Elisha?
- [83.] What Bezaluel Flagg, of Petersham, was it, who m., in Bridgewater, in 1780, Abigail (or Abiel) Edson? [See Mitchell, p. 152.]
- p. 223. [89.] Timothy Flagg belonged to Capt. Jonathan Brown's Co., in 1758.
- [92.] The Will of Benjamin Flagg, Esq., of Worcester, dated June 8, 1751, mentions wife Elizabeth, sons Benjamin, William, Asa (sole ex'r), dr. Elizabeth, wife of Abraham Rice; dr. Abigail, wife of Samuel Hubbard, and dr. Mary Flagg.
- p. 224. [141-1.] Isaac Flagg, Jr., m. Elizabeth Wilson, of N. Hampshire.
- [141-2.] Sally Flagg m. Jonathan Fiske [N. Fiske, 136].
- [141-9.] Mary Flagg (9th child of Isaac and Sarah), m., Ap. 28, 1816, Matthew Bridge, son of Richard Perkins Bridge. [Bridge, 45.]

p. 225. **FLEET.**—Strike this out, and see Flagg [4.] in Part II.

FLEMING.—John Fleming, was selectman 1649. His Inventory, dated June 13, 1757, by John Coolidge, John Livermore, and John Wincoll. House, barn, malt-house, &c., £120. House, &c., bought of Thomas Tarball, £25. Four other parcels of land and personal estate. His estate was divided Ap., 1659, giving eldest son a double portion.

Thomas Fleming, probably went to England late in the year 1658. Oct., 1658, Thomas Fleming ordered by the court to pay the costs of his servant, Thomas Browning, he (Browning) to make recompense at the end of his term. [See Browning.] As appears in the text, he was of Romford, Co. Essex, Eng., the next Feb., 1659. Oct. 2, 1660, John Flemming (Jr.), Samuel Sternes, John Winter, Nathaniel Bowman, and John Page, convicted of being at an uncivil meeting of sundry young persons, were sentenced to pay the constable's fees, 6s. It was on the same day that John Flemming obtained permission of the court, to engage in seafaring employment.

FLOWERS.—Thomas Flowers, came from Maryland to Wat., in 1756.

FOLEY.—John Foley, from Ireland, m., in 1778, Anna Rogers, b. Nov. 30, 1757, dr. of John and Hannah (Williams) Rogers, machinist and clock-maker, of Newton. Chil., 1. James, a shipmaster. 2. Christopher, unm. 3. John, m. — Parker, of Boston, and had son John, who m. Abby, dr. of Dea. Samuel Townsend [21]. 4. William, b. Oct. 8, 1786; m. and settled in Providence. 5. Sophia, b. Sept. 15, 1795; m. Rev. Francis Green Macomber [see p. 354], a Baptist clergyman, of Beverly.

FOOTE.—For a copious and well-executed genealogy of the family and very numerous descendants of Nathaniel Foote, a very early emigrant from Watertown to Wethersfield, see "The Foote Family," by Nathaniel Goodwin, published in Hartford, 1849.

FOSTER.—Abiah Foster, moved from Waltham to Wat., in 1761. John Foster, moved from Rox. to Wat., in Ap., 1764.

FOWLE.—[1.] For 1752, read 1751. He was probably the Edmund Fowle, son of Edmund and Mary, b. in Newton, Sept. 23, 1719.
 p. 226. [3.] Edmund Fowle, was selectman 1795, 1805, 6. He d. Sept. 28, 1821, aged 74; and his wid. Huldah, d. in Wat., Feb. 21, 1842, aged 85. His dr. Mary, d. May 11, 1823, unm. His dr. Huldah, d. May 6, 1822, unm.
 [7.] Capt. JOHN FOWLE, was selectman 1790, 92. His son *Charles*, was killed in a duel; son *John*, of the U. S. Army, was killed at Cincinnati, by the explosion of the Steamer *Moselle*; dr. *Harriet* m. *William Smith*, of Lowell; dr. *Elizabeth* m. *Charles Smith*, of Quincy; dr. *Maria*, m. — *Britton*, of Orford, N. H.
 [9.] Chil. of Jeremiah, 1. Cromwell, d. May 25, 1823, aged 22. 2. Caroline, m. — Etheridge, of Charlestown.

FOX.—Thomas Fox, m., Ap. 24, 1683, Elizabeth, wid. of Charles Chadwick (who d. Ap. 10, 1682). She d. Feb. 22, 1684-5, aged 70. Thomas Fox was Rep. of Wat., 1688, and "Father Fox," was chosen tythingman, 9 months after the above marriage. Mr. Shattuck, p. 371, says, Thomas Fox, Sen., d. Ap. 14, 1658. It seems to me more probable, that it was the son Thomas, who d. at that time; and that Thomas Fox, Sen., was the "Father Fox," who m. the widow Chadwick. From the age of the bride (aged 69), we infer that he was an old man. It is conjectured, that his 2d wife, Hannah, was a daughter of Capt. Thomas Brooks, that she, and her son Thomas, and probably her daughter, died before her father, and is not therefore, mentioned in the settlement of his estate. We insert the little we have gleaned, with respect to the family of Thomas Fox, of Concord, accompanied with our conjectures, to be confirmed or confuted by others.

THOMAS FOX, m. (1st), REBECCA —. She d. May 11, 1647, and he m. (2d), Dec. 13, 1647, HANNAH BROOKS. As the birth of no child of hers is recorded after 1650, she probably died soon, and before her supposed father, Capt. Brooks. He m. (3d), ELLEN, wid. of Percival Green,* of Camb., where he settled, and was a member of the church as early as 1658, and was this year selectman. She d. in Camb., May 27, 1682, aged 82 years; ten months before his m. to wid. E. Chadwick. He d. in Camb., Ap. 25, 1693, æt. 86. [See Camb. Epitaphs.]

1. *Eliphalet*, m., 1665, *Mary Wheeler*, dr. of George and Catherine, of Concord. He m. (2d), in 1681 or 82, *Mary*, wid. of Isaac Hunt, and dr. of John and Anne (How) Stone, of Sudbury. [See How.] She d. about 1686. [She had m., May 14, 1667, Isaac Hunt (? son of Wm., of Concord.) He d. Dec., 1680, leaving 6 children. By her 2d husband, E. Fox, she had 2 children.] He d. Aug. 15, 1711.

2. *Elizabeth*, b. Sept. 18, 1642; m., Oct. 3, 1665, *John Ball, Jr.*, of Wat. [2.], his 2d wife.

3. *Mary* (twin), b. Sept. 18; d. Oct. 9, 1642.

(By 2d wife Hannah.)

4. *Hannah*, b. Sept. 25, 1648, probably d. young.

5. *Thomas*, b. Feb. 26, 1649-50; d. 1658. 6. (?) *Jabez*.

* John Green, the only son of Percival and Ellen Green, of Camb., m., Oct. 20, 1656, Ruth, dr. of Edward and Ruth (Bushell ? Bushnell) Mitchelson, of Camb., and had 1. John. 2. Nathaniel. 3. Percival, b. Mar. 29, 1660; grad. Harv. Coll., 1680; d. in Camb., July 10, 1684. 4. Ruth. 5. Samuel. 6. Elizabeth. 7. Edward. He succeeded his father-in-law, E. Mitchelson, as Marshal-General, and d. Mar. 3, 1691, aged 65.

FREEMAN.—The name of Samuel Freeman's wife in the records is Appia (Apphia). May 31, 1648, Henry Freeman, of Wat., mortgaged his house with 2 A. of land in Wat., situated between Joseph Tainter and Richard Gale, to John Newgate, of Boston, and William Barber, of (?) Ludgate, in consideration of their releasing him from a bond in favor of John Freeman, of Westminster. [Suff. Deeds I., p. 91.] This renders it probable that he was from Westminster, or that vicinity. There is no record of any children of Henry Freeman, of Watertown, but probably James, of Boston, and Samuel, of Sudbury, were his sons. May 3, 1704, Mary Sherman, of Wat., and James Sherman, of Sud. [Ex'rs of Rev. John Sherman], for £40, sold to Samuel Freeman, of Sud., weaver, and James Freeman, of Boston, brewer, 4 acres in Wat., near the Farms [Weston] meeting-house, bounded N.W. by Thomas Woolson; S.E. by land of — Loveran, d.; S.W. and N.E. by squadron line; only excepting what is sold to the Farms for a burying-place. James Freeman, administrator of John Freeman, of Newton, Ap., 1705. Jan., 1713–14, Apphia Freeman, from Cambridge, was warned out of town. She became pauper, and was buried in May, 1723, when the selectmen ordered 5 quarts of rum to be bought for her funeral! Her parentage not ascertained.

- p. 227. **FULHAM.**—Francis Fulham, Esq., was for a long time the most influential man in Weston. The Registry of Deeds shows that he purchased numerous lots or parcels of land, generally situated in the S.W. part of the town. Jan. 4, 1697–8, James Barnard, of Sud., sold to Francis Fulham, of Wat. [Farms], 60 A. in Wat., near Sudbury, a quarter of the farm called Barnard's Farm, "near the Land of Contention, so called." Feb. 10, 1707–8, same sold to same, 24 A. in S.W. corner of Watertown [Farms], part of a grant of 236 A. called Land of Contention. [See Eddy [6.], Part II.] He was selectman 1710, '11, before the separation, Weston from Wat., and afterwards, he held numerous responsible offices. [See Bond, 35.] The date of his decease has not been ascertained; but he lived to advanced age, for "Col. Francis Fulham," was Moderator of a town-meeting, Mar. 25, 1751. Mar. 30, 1752, he resigned his agency for collecting rents for the proprietors of Natick, and for paying to each his due share. The records of Natick were in his keeping as early as 1719.
- [3.] Francis, m., Dec. 4, 1740, Susanna Hammond, dr. of Eleazer and Hannah (Harrington) Hammond, of Newton. [T. Hammond 70, Part II.]
- [4.] Jacob Fulham d. in Leominster, Oct. 20, 1833, aged 83, probably a son of Jacob and Hannah (Ware), of Weston.
- [12.] For Mar. 30, read May 30. Sarah Fulham, was the 2d wife of Dea. Wm. Trowbridge. 5 chil. [See Trowbridge, 18, Part II.]

FULLER.—William Fuller, aged 25, and John Fuller, aged 15, embarked in the Abigail, in May, 1635, for New England. This age of John does not correspond with the age of the first John Fuller, of Newton, who d. Feb. 7, 1698–9, aged 87. Perhaps there is an error in one of these dates. Elizabeth, wid. of John Fuller, of Newton, d. Ap. 13, 1700.

The family and descendants of John Fuller, of Newton, are so very intimately associated with Watertown families, and what was printed on pp. 227–8, contains some errors, and so many deficiencies, that a brief, condensed genealogy is here inserted. That large tract of land called the Fuller Farm, and upon which most of the families of this name have resided, was situated in the bend of Charles River, opposite to Waltham Plain. It included nearly all the land lately taken from Newton, and annexed to Waltham. It was, however, more extensive, extending farther down, and farther back from the river. For a view of the topography of this farm, and a more copious account of this family, see Jackson's excellent History and Map of Newton, to which we are much indebted.

CHILDREN OF JOHN AND ELIZABETH FULLER.

- 2 1. ELIZABETH, m., 1663, JOB HYDE [2.] She d. Nov. 28, 1685.
 10. 3 2. JOHN, b. 1645; d. Jan. 21, 1720, aged 75 [gravestone].
 52. 4 3. JONATHAN, b. 1648; d. Aug. 12, 1722, aged 74.
 52. 5 4. JOSEPH, b. Feb. 10, 1652; d. Jan. 7, 1740, aged 88.
 108. 6 5. JOSHUA, b. Ap. 2, 1654; d. June 27, 1752, aged 98.

116. 7 6. JEREMIAH, b. Feb. 4, 1658; d. Dec. 23, 1743, aged 85.
 8 7. BETHIA, b. Nov. 23, 1661; m., Feb. 27, 1684-5, Lieut. NATHANIEL BOND [31].
 9 8. ISAAC, b. Dec. 2, 1665; d. Oct. 6, 1691, probably unm.
-
3. 10 (II.) JOHN FULLER, Jr., m. (1st), 1682, ABIGAIL BALSTON [not Boylston.] He m. (2d), Oct. 14, 1714, MARGARET HICKS. His Will, dated June 27, 171-, proved 1720, mentions wife Margaret, 4 sons and 3 drs., and made his 4 brothers exe'rs. Chil.,
-
- 11 1. SARAH, b. Oct. 5, 1683.
 12 2. JOHN, b. Sept. 2, 1685; m., Aug. 1709, SARAH CHINERY [5]. Chil.,
 13 1. *Elizabeth*, b. June 27, 1712. 2. *James*, b. Feb. 9, 1715.
 15 3. *Abigail*, b. Ap. 9, 1717. 4. *Mary*, b. June 2, 1720.
 17 5. *Jerusha*, b. Oct. 16, 1722. 6. *Eunice*, b. Aug. 6, 1725.
 19 7. *Rebecca*, b. Sept. 21, 1730. 8. *Sarah*, b. July 8, 1733.
 21 9. *Elisha*, b. Oct. 11, 1735.
 22 3. ABIGAIL, b. Mar. 8, 1688. 4. JAMES, b. Feb. 4, 1690.
 24 5. HANNAH, b. Aug. 31, 1693.
 25 6. ISAAC, b. Nov. 22, 1695; m. ABIGAIL —. He d. Oct. 14, 1755, and admin. was granted to his wid. Abigail and son Samuel.
 26 1. *John*, b. July 3, 1722; d. in infancy.
 27 2. *Abijah*, b. June 1, 1723; m. 1755, *Lydia Richardson*. 7 chil.
 27 3. *Samuel*, b. Nov. 26, 1724; m., Oct. 9, 1746, *Lydia Stearns*. [C. Stearns, 116.] She d. 1753. Chil.,
 28 1. *Samuel*, b. May 2, 1748. 2. *Sarah*, b. Oct. 1749.
 30 3. *Lydia*, b. Oct. 23, 1752; m., June 10, 1772, *Silas Stearns*. [C. Stearns, 112.]
 31 4. *Lois* (twin), b. Oct. 23, 1752.
 32 4. *Richard*, b. 1728; m. 1757, *Eunice Child* [? 18-5-3.]
 33 5. *Priscilla* (twin), b. 1728; d. 1763, unm.
 7. JONATHAN, b. Feb. 13, 1698.
 34 8. JONATHAN, b. Mar. 28, 1700; m., Jan. 2, 1725, ELIZABETH WOODWARD. [Woodward, 35.] He d. Mar. 3, 1783. Chil.,
 35 1. *Kezia*, b. Oct. 7, 1725; d. 1741. 2. *Jonas*, b. Ap. 23, 1727. 3. *John*.
 37 4. *Hulda*, b. Feb. 10, 1729; m., Mar. 1749, *Joshua Jackson*, b. Ap. 26, 1726, son of Edward and Abigail (Gale) Jackson. 11 chil. [See Jackson's History, p. 342, and see Gale, 19.]
 38 5. *Elizabeth*, b. Nov. 10, 1730; m., 1756, *Samuel Gooding*, of Wat., and of Waltham, 1765.
 39 6. *Daniel*, b. Aug. 13, 1732. 7. *Grace*, b. June 14, 1734.
 41 8. *Elinor*, b. Mar. 14, 1736. 9. *Amos*, b. Feb. 7, 1738.
 43 10. *Thaddeus*, b. Feb. 17, 1740. 11. *Mary*, b. Sept. 1744.
 45 9. CALEB, b. Feb. 24, 1702; d. 1770; m. (1st), Jan. 24, 1724-5, TEMPERANCE HYDE [9]. She d. Aug. 25, 1749. He m. (2d), in Wat., Dec. 27, 1750, MARY HOVEY. Chil.,
 46 1. *Ephraim*, b. Dec. 31, 1725; m. 1746, *Esther Warren*. 5 chil.
 47 2. *Nehemiah*, b. Sept. 16, 1727; d. 1735.
 48 3. *William*, b. June 2, 1732; d. 1802; m. *Elizabeth* —. 2 chil.
 48 1. *Caty*, b. Feb. 23, 1763; m., 1794, *Nahum Smith*, of Needham.
 49 2. *Nathaniel*, b. Dec. 25, 1760; d. Dec. 1817; m., 1786, *Elizabeth Jackson* (?) b. Feb. 17, 1743, dr. of Michael and Phebe (Patten) Jackson. 1 child, *Nathaniel*, b. Aug. 1, 1788.
 50 4. *Bethia*, b. Nov. 13, 1734; d. before 1760; m. *John Murdock*, of Uxb.
 5. *Ann*, b. Mar. 31, 1739, d. 1745.
-
4. 51 (II.) JONATHAN FULLER m. MINDWELL, dr. of Dea. James Trowbridge [see Trowbridge, 3.] He d. Aug. 12, 1722, aged 74, s. p., and his wid., Mindwell, d. 1758, aged 96. He bequeathed his estate to Jonathan Fuller [66], son of his brother Joseph; £10 to his nephew, Jonathan Hyde [Hyde, 20]; £2 to chil. of Eleazer Hyde [18]; £5 to Rev. John Cotton; £2 to wife of Nathaniel Oliver [only dr. of his sister Bethia].

5. 52 (II.) JOSEPH FULLER m., Feb. 13, 1680-1, LYDIA JACKSON, b. 1656. dr. of Edward, Sen., and Elizabeth (Newgate) Jackson. She d. Jan. 12, 1726, aged 70, and he d. Jan. 5, 1740, aged 88. He was selectman 5 yrs. Chil,
- 53 1. JOHN, b. Dec. 15, 1681; m., Feb. 25, 1716, HANNAH, wid. of James Trowbridge, Jr., and dr. of Abraham Jackson [see Biscoe, 10]. He d. 1718, aged 38 y 10 m., and she d. before 1740. Chil.,
 1. *Joseph*. 2. *Lydia* (twins), b. Sept. 21, 1716; d. 1716.
- 54 3. *Lydia*, b. Dec. 8, 1717 (?) m. *Nathaniel Felch*.
- 55 2. JOSEPH, b. July 4, 1685; a Lieut.; m. SARAH JACKSON [see Biscoe, 11]. He was chosen Rep. in 1749, but declined serving. She d. Nov. 21, 1764, aged 81, and he d. Ap. 21, 1766. aged 81.
- 56 1. *Abraham*, b. Mar. 23, 1720; was teacher of a private grammar school in Newton, previous to 1760; Town Clerk and Treasurer 27 years from 1766; Rep. 18 yrs.; Delegate to the Provincial Congress; State Senator and Councillor, and Judge C.C.P. By his Will, dated 1793, he bequeathed £300, "for the purpose of laying the foundation of an Academy in Newton." He m., in 1758, *Sarah Dyer*, of Weymouth. He d. Ap. 20, 1794, aged 74, and she d. Ap. 7, 1803. Chil.,
- 57 1. Sarah, b. Ap. 27, 1759; m., 1781, Gen. William Hull, b. at Derby, Conn. June 24, 1753. He d. Nov. 29, 1825, and she d. Aug. 1, 1826. [See Hist. of Newton, p. 312, and the Life of Gen. Hull, by M. Campbell and J. F. Clarke.] Chil.,
 1. Sarah, b. Jan. 20, 1783; m. in 1802, John M'Kesson.
 58 2. Eliza, b. June 22, 1784; m., in 1805, Isaac M'Lellan.
 59 3. Abraham Fuller, b. Mar. 8, 1786; a Capt. U. S. Army, slain in
 60 the battle of Bridgewater, July 25, 1814.
 61 4. Nancy Binney, b. June 19, 1787; m. — Hickman.
 62 5. Maria, b. June 7, 1788; m. — Campbell.
 63 6. Rebecca Parker, b. Feb. 7, 1790; m. Dr. Samuel Clarke.
 64 7. Caroline, b. Ap. 30, 1793.
 2. Joseph, b. Aug. 8, 1765; d. 1765.
- 65 2. *Elizabeth*, b. Oct. 28, 1722; m., in 1749, Rev. *Isaac Jones*, of Weston.
- 66 3. JONATHAN, b. Jan. 7, 1686; Captain, selectman 7 years. He m., in 1717, SARAH MYRICK (or Mirick) [Myrick, 19]. He bequeathed his homestead to his son Edward. He d. Dec. 1, 1764, and his wid. Sarah d. Sept. 21, 1772. Chil.,
 1. *Elisha*, b. Mar. 15, 1719, d. soon.
 67 2. *Sarah*, b. Oct. 20, 1720; m. *Abijah Learned* [85].
 68 3. *Jonathan*, b. July 13, 1723; m., in 1748, *Eleanor Hammond* [T. Hammond, 79, in Part II.] 3 sons and 6 drs.
 69 4. *Elisha*, b. Oct. 11, 1725; m. in 1750, *Esther*, dr. of David Richardson. He d. 1794. Chil.,
 70 1. *Esther*, b. Sept. 2, 1751; m. 1772, Edward Hall, Jr.
 71 2. *Elisha*, b. Aug. 10, 1753; d. Mar. 1773.
 72 3. *Aaron*, b. Feb. 26, 1756; m., 1784, Hannah Pond.
 73 4. *Hannah*, b. Feb. 28, 1759. 5. *Rhoda*, b. June 19, 1761.
 75 6. *Patty*, b. Aug. 12, 1763; m. 1791, Sylvanus Lowell.
 76 7. *Silas*, b. Dec. 21, 1765; m. in 1793, Ruth, dr. of William Hoogs.
 8 chil.,
 8. *Caty*, b. Sept. 10, 1768. 9. *Caty*, b. Nov. 25, 1770, d. soon.
 77 10. *Nabby*, b. May 5, 1773.
- 78 5. *Esther*, b. Sept. 28, 1727; m. — *Parker*.
- 79 6. *Amariah*, b. July 17, 1729; a Captain, with his company of 104 men, was in the battle of Concord and Lexington, and on Dorchester Heights. He m., in 1757, *Anna Stone*, b. 1734, dr. of Dea. John and Abigail (Stratton) Stone [Stone, 74.] He d. Feb. 2, 1802, and his wid. d. Jan. 1813. Chil.,
 80 1. *Catherine*, b. Sept. 14, 1759; m. Dea. Ebenezer Woodward [79].
 81 2. *Elijah*, b. June 12, 1762; d. 1775. 3. *Meriel*, b. Ap. 17, 1764.
 82 4. *Anna*, b. Jan. 29, 1770; m., 1797, Henry Craft.
- 83 7. *Edward*, b. Dec. 31, 1735; a selectman 7 yrs., Rep. 1787, Lieut. in the battles of Concord and Lexington, a Captain at the capture of Burgoyne's army. He m., in 1759, *Ruth*, dr. of Isaac and Ruth (Greenwood) Jackson. She d. 1784, and he m. (2d) 1789, *Abigail*, wid. of John Marean, and dr. of

- John and Margaret (Wilson) Hammond [see T. Hammond, Part II., 1404.] He d. Dec. 1810, and his wid. Abigail d. 1826, aged 85. Chil.,
- 84 1. Ruth, b. July 19, 1762; m. Capt. Edmund Trowbridge.
 85 2. Oliver, b. Nov. 12, 1764, d. 1846.
 86 3. Jonathan, b. Ap. 23, 1767; m. Betsey —, and went to Warren, Me.
 87 4. Ezra, b. Sept. 16, 1769. 5. Dorcas, b. Oct. 26, 1771.
 89 6. Jerusha, b. Mar. 9, 1774, d. 1848; m., Sept. 29, 1799, Capt. Daniel Coolidge [355]. 11 chil.
 90 7. Edward, b. Aug. 7, 1776. 8. Simon, b. Feb. 9, 1779.
 92 9. Charles, b. Mar. 5, 1781.
- 93 4. LYDIA, b. Feb. 15, 1692; m. — STRATTON.
 94 5. EDWARD, b. Mar. 7, 1694; m., Sept. 21, 1726, ESTHER COWDIN. He d. Nov. 23, 1732, leaving dr. *Lucy*, b. May 13, 1729.
- 95 6. ISAAC, b. Mar. 16, 1698; m., Sept. 17, 1722, HANNAH GREENWOOD, b. Mar. 4, 1699, dr. of Esq. John and Hannah (Trowbridge) Greenwood. He d. June, 1745, aged 47; his wid. Hannah d. 1769. Chil.,
- 96 1. *Susanna*, b. July 13, 1725, d. 1748.
 97 2. *Joseph*, b. Aug. 15, 1727; d. 1807, aged 80. He was a Captain, and with a company of 96 men, which he raised, he marched to Bennington, thence to Skenesborough and Lake George, to oppose the progress of Gen. Burgoyne; thence to Cambridge, to guard the captured troops of Burgoyne. He m. (1st), in 1756, *Mindwell Stone* [Stone, 72.] She d. 1777, aged 46, and he m. (2d), in 1781, *Mehitabel Craft*. He was a selectman of Newton. Chil.,
- 98 1. *Asa*, b. June 17, 1757; m., in 1786, Betsey (Elizabeth) Winchester, b. Jan. 20, 1765, dr. of Stephen and Hannah (Hastings) Winchester. 6 chil. He d. at St. Albans, Vt.
 99 2. *Lois*, b. in Brookline, 1758; m., 1784, Joshua Park.
 100 3. *Susanna*, b. Oct. 9, 1760; m. John Cook, of Wat. [40.]
 101 4. *Abigail*, b. July 14, 1765; m. Edward Duxant.
 102 5. *Mindwell*, m., in 1793, Dea. Ebenezer White.
 103 3. *Ruth*, b. Sept. 18, 1729; m., in 1751, *Peter Durell*.
 104 4. *Lois*, b. Dec. 12, 1732; d. 1749. 5. *Tubitha*, b. Sept. 7, 1734.
 105 6. *Hannah*, b. Nov. 11, 1735; m., Sept. 4, 1755, *Daniel Stearns*. [C. Stearns, 118.]
 106 7. *Lydia*, b. Oct. 23, 1737; m., June, 1756, *Daniel Fuller*.
 8. *Abigail*, d. 1753.
- 107 7. ELIZABETH, b. July 1, 1701; m. JOSIAH BOND. [Bond, 118.]
-
6. 108 (II.) JOSHUA FULLER m. (1st), June 7, 1679, ELIZABETH WARD, b. June 18, 1660, dr. of John and Hannah (Jackson) Ward. She d. Aug. 17, 1691, aged 31. (2d wife no record of.) He m. (3d), July 19, 1742, MARY DANA, of Camb. (he in his 88th year, and she in her 75th year). He d. June 27, 1752, aged 98. [See Ward Family, pp. 10 and 19.]
-
- 109 1. ELIZABETH, b. Feb. 22, 1679-80; m. (1st), Dec. 31, 1702, ISAAC SHEPPARD, of Charlestown, and settled in Norton. He d., and she m. (2d), — ALLEN.
 110 2. HANNAH, b. July 8, 1682, m. STEPHEN COOK, Jr., of Wat. [Cook, 12.]
 111 3. EXPERIENCE, b. Nov. 5, 1685; m. JOHN CHILD [14].
 112 4. MERCY, b. Mar. 11, 1688-9; m. AARON CADY. [Cady, 31, Part II.]
 (By 2d wife (?) Abigail.)
 113 5. ABIGAIL, b. about 1697; m., Dec. 3, 1718, JOSEPH GARFIELD [31].
 114 6. SARAH, m. July 7, 1717, RICHARD PARK, Jr. [12.]
 115 7. RUTH, m., about 1723, EBENEZER CHINERY [8.], his 2d wife.
-
7. 116 (II.) Lieut. JEREMIAH FULLER m. (1st), MARY —, she d. 1689, s. p. He m. (2d), ELIZABETH —. She d. in 1700. He m. (3d) THANKFUL —. She d. 1729. He had a fourth wife, who d. in 1742. He d. Dec. 23, 1742, aged 85. He was selectman 16 years, and moderator of town meetings many years. By his Will, dated 1742, he gave to son Thomas 92 A. of land; to son Joshua his homestead, 125 acres; to son Josiah, 66 A.; his books to be equally divided among his children.
 (Chil. by 2d wife, Elizabeth.)
 1. ELIZABETH, b. Ap. 14, 1694, d. 1694. 2. JEREMIAH, b. July 3, 1697, d. 1703.

(By 3d wife, Thankful.)

- 117 3. THOMAS, b. Sept. 12, 1701; m., Ap. 9, 1728, ELIZABETH BALL, of Wat. [21.]
He d. Nov. 13, 1748, aged 47.
- 118 1. *Thankful*, b. July 26, 1730. 2. *Rachel*, b. July 12, 1734, d. 1737.
- 119 3. *Jeremiah*, b. May 14, 1736; m., 1759, *Sarah Robinson*.
- 120 4. *Thomas*, b. Sept. 25, 1738; m., 1763, *Hannah Kingsbury*. He is supposed
to be the father of Thomas. [See Bond, 400.]
- 121 5. *Nathan*, b. June 3, 1741; Captain of a company at Cambridge, in June,
1775. In 1776 he was a major of the same regiment under Col. Bond. For
an account of his patriotic military service, see Gordon's History, Vol. II.,
pp. 206-62; also, History of Newton, p. 283. He attained the rank of
Colonel after he left the army. He m., July 4, 1763, *Beulah Craft*, dr. of
Dr. Moses and Esther (Woodward) Craft. He was Rep. in 1795. In 1781
he gave one and a half acre to the West Parish for a graveyard, and in
1785, he gave the church and society £60. By his Will, dated 1817, he
gave to his nephew, Benjamin Fuller [123], his homestead. Inventory,
homestead, 55 A., £2890; total, £3267. He d. Sept. 21, 1822, aged 81,
s. p., and his wid. d. Nov. 16, 1818, aged 73.
- 122 6. *Benjamin*, b. Nov. 15, 1743; m., 1768, *Hannah Child*. Chil.,
- 123 1. Benjamin. 2. Leonard. 3. Nathan. 4. Beulah.
- 127 4. JOSHUA, b. Ap. 12, 1703; a captain. His 1st wife d. Nov. 28, 1729, and he m.
(2d), May 22, 1746, ANNA STEARNS [I. Stearns, 56, III.] He d. Aug. 23, 1777,
aged 75, and his wid., Ann, d. 1778, aged 61. Chil.,
- 128 1. *Joshua*, b. Mar. 2, 1747; a Lieut.; m. 1773, *Catherine*, sister of Col. Michael
Jackson. She d. 1777, and he m. (2d), wid. *Mary (Brewer) White*. He d.
Nov. 1817, aged 70. Chil.,
- 129 1. Henry, b. June 21, 1773, d. 1777.
2. Joshua, b. Sept. 16, 1774; m., Mar. 20, 1800, Hannah Greenwood.
He d. July 12, 1805, and his wid. m. Daniel Sanger, of Wat.
- 130 3. Jacob, b. Mar. 30, 1776. 4. Moses, d. young.
(By 2d wife, Mary.)
- 131 5. Catherine, m. Charles Jackson. 6. Rebecca.
- 133 7. James. 8. Elijah, of Boston. 9. Uriel, and drs.
- 137 2. *Ann*, b. June 18, 1749; m. 1774, *Ephraim Whitney*, who d. 1776, in the
army.
- 138 3. *David*, b. Ap. 18, 1751; m. 1779, *Sarah Williams*. 5 chil.
- 139 4. *Moses*, b. Ap. 1, 1753. 5. *Eunice*, b. Feb. 15, 1756; bap. in Waltham,
Feb. 22, 1756.
- 141 6. *Rachel*, b. Ap. 29, 1760; bap. in Waltham, May 4, 1760; d. 1778; she
m. Col. *Josiah Fuller*, his 2d wife. [145.]
- 142 7. *Nathaniel*, bap. in W., Feb. 27, 1763.
- 143 5. THANKFUL, b. Dec. 23, 1704; m., 1720, NOAH WISWALL.
- 144 6. JEREMIAH, b. Nov. 1, 1707; d. 1711. 7. ELIZABETH, b. Aug. 24, 1709; d. 1711.
- 145 8. JOSIAH, b. Dec. 2, 1710; d. 1793; an ensign; m., in 1739, ABIGAIL WILLIAMS,
dr. of Isaac, Jr., and Martha (Whitman) Williams. She d. 1796, aged 86. Chil.,
1. *Josiah*, b. Oct. 24, 1739; a selectman 3 years, and colonel; m. (1st), 1761,
Ann Priest [17]. He m. (2d), *Eunice Fuller* [140]. She d. 1778, and
he m. (3d), 1779, *Mary Dana*. He m. (4th), *Mary Woodward* [?59.] He
m. (5th), in 1808, *Mary Perry*. He d. Mar. 22, 1845, aged 84. Chil.,
1. *Eunice*. 2. *Rachel* (twins), by 2d wife, b. and d. 1778.
(By 3d wife, Mary.)
- 146 3. *Sally*, b. Mar. 9, 1781; m., May, 1800, Amasa Winchester, of Boston.
- 147 4. *Ann*, b. July 12, 1783; m., Nov., 1800, Wm. Winchester, of Rox.
(By 4th wife, Mary.)
- 148 5. *Josiah*, b. Sept. 13, 1785; m., in 1809, Sarah, dr. of Rev. William
Greenough. He d. Ap., 1838, and she d. Dec., 1815. 4 chil.
- 149 2. *David*, b. Oct. 13, 1741; m. *Sarah Williams*, b. Aug. 27, 1750, dr. of Isaac
and Sarah (Stratton) Williams. She d. a wid. 1813.
1. *Eunice*, b. 1779; d. 1799, unm. 2. *David*, d. unm.
- 150 3. *Sarah*, m. Dea. Joel Fuller. 4. *Martha*, d. unm., aged 28.
- 151 5. *Hannah*, m. — Goodrich, of Fitchburg.
- 152 3. *Phebe*, b. Jan. 29, 1744; m., 1766, *William Clark*, Jr.
- 153 4. *Ann*, b. June 4, 1746, m. *Benjamin Richards*, of Rox.

- 154 | 5. *Abigail*, b. Nov. 3, 1747; m. (1st), Feb., 1765, *John Barber*, and m. (2d),
Samuel Jenks, Esq.
 155 | 6. *Mary*, b. Oct. 24, 174—; m., 1769, *Thomas Miller*, Jr.
 156 | 7. *Thankful*, b. Feb. 21, 1750.
 157 | 8. *Susanna*, b. June 2, 1753; m., 1771, *Stephen Hastings*.
 158 | 9. *Martha*, b. Aug. 21, 1755; m., 1775, *Daniel Stratton*, of Wat. [78.]
 159 | 10. *Patty*.

- p. 229. **GAGE.**—[3.] Nov. 8, 1751, the estate of Isaac Gage, of Weston, distributed to mother *Mary*; brothers *Robert*, *Phillip*, and *Jonathan*; sister *Lydia*, in her 20th year, in 1748, and *Alice*, in her 16th year, in 1748. Ap., 1744, a *Lydia Gage*, aged 27, went from Weston to Watertown.
 [4.] *Philip Gage*, adm. f. c. Nov. 16, 1743, and he and wife dismissed to *Sturbridge*, Jan. 8, 1760.
 [5.] *Rachel*, adm. f. c. in Wat. Dec., 1742; d. Jan. 19, 1746.

GALE.—[5½.] Perhaps this *Abigail*, was the widow of *Richard*, a 2d wife.

- [6.] *Abraham Gale*, selectman of Wat., 1706.
 [13—3.] (?) *Hannah Goodall*, formerly *Gale*, dismissed from *Waltham* to *Sutton*, Nov. 19, 1738.
 [21.] Testimony in a suit, 1679. *John Gale*, son of *Richard*, in 1677, was a goodwiller to y^e daughter of *Henry Spring*. *Henry Spring*, Sen., and *Mehitabel* his wife, (testified that) *Goodm. Richard Gale* came to our house to ask our goodwill to make a match between our daughter *Elizabeth* and his son *John*. He promised to give his son *John* half his farm, &c.
 p. 230. [30.] *Abraham Gale*, selectman of *Watertown*, 1718.
 [42.] *Jonathan*. See *History of Norwich*, p. 146.
 [70.] *Esther Gale*, went to Wat. Aug., 1749.
 [73.] Suit, 1735, *Samuel Gale* and wife *Rebecca*, vs. *Benjamin Shattuck*, admin'r of *Amos Shattuck*, of Wat., d. She kept his (A. S.) house from Mar. 1, 1719, to June 1, 1722, while sole. Estate of *Samuel Gale*, of *Waltham*, admin. by son *Samuel*, Feb. 5, 1749.

- p. 231. **GALUSHA.**—Mar. 8, 1742—3, caution against (settlement of) *Samuel Galusha*, from *Boston*, and his wife, from *Concord*, Dec. last. Mar. 13, 1743—4, caution by *Chelmsford*, against (settlement of) *Samuel Galusha*, and wife *Esther*, "from *Watertown*, it is thought." Mar. 11, 1713—4, caution against (settlement of) wid. *Hannah Galusha*, from *Brookline*.

GAMAGE.—Mar. 13, 1743—4, caution against (settlement of) *Nathaniel Gamage*, wife and 3 chil., from *Cambridge*, Oct. 19, last.

July 19, 1761, *Medford* cautioned against (settlement of) *Mary ? Gamel*, from *Watertown*, Mar. 27.

GARDNER.—Mar. 13, 1759. Caution against (settlement of) *Margaret Gardner*, from *Boston*, Mar., 1758. She went to *Cambridge*, Nov., 1764. *Henry Gardner*, Esq., resided in Wat., in Nov., 1775.

- p. 232. **GARFIELD.**—[2½.] On Court File, is a petition of the selectmen of Wat., dated Dec. 30, 1691, stating that *Samuel Garfield* was an inhabitant of *Cambridge* above 20 years past; was servant of *Justinian Holden*, who died last autumn; then he (S. G.) was put away by the wid.; thence he came to Wat., to the house of *Elliz Barron*, whose wife had skill in matters of surgery; that *Barron* being weary of him, he came to the selectmen, who refused to receive him as an inhabitant. Ap. 11, 1692, *Mary Holden* (wid. of *Justinian*), aged 45, testified that *S. Garfield* lived with her husband *Justinian*, 1½ years, in the limits of Wat., some few months before his decease. This time (1½ years) was probably after his return from *Salem*; for one petition on file states, that the 20 yrs. of absence from Wat. was partly spent at *Salem*, where he was an inhabitant, paid taxes, and was impressed in the *Indian War*. *William Shattuck* and others testified, Ap. 19, 1692, that *Justinian Holden* moved to his farm in *Camb.*, last part of Dec. or beginning of *January*, and there re-

- mained till the day of his death, about the middle of August following—that Garfield had been his servant 18 or 19 years.
- [2½–10.] Caleb Burbank, of Rowley, m., in Salem, Jan. 2, 1693, Lydia Garfield, of Watertown. Robert Garfield [? parentage], and Deborah Holman, m., in Wat., Nov. 3, 1687.
- [7.] Joseph Garfield, d. Aug. 22, 1692, and admin. was granted Feb. 27, 1692–3, to wid. Sarah, and son Benjamin. Inventory, homestall, &c., and 140 A. £70. 7 A. in Chester Meadow, £14. Abraham Gale was guardian of Jerusha and Rebecca; Edward Garfield was guardian of his brother John, and sister Grace. Sept. 25, 1668, Joseph Garfield, of Wat., and wife Sarah, sold to his brother Benjamin, 130 acres in Sudbury.
- [10.] Benjamin, m. Bethia Howe. [See Barry, p. 293.]
- [11.] See Barry, p. 353.
- [17.] For 168—, read 1682. Ap. 1, 1673, Benjamin Garfield received of Elliz Barron (step-father of his wife), £20, the share of his wife in the estate of her father, T. Hawkins. This was probably near the date of their marriage. Autographs of Capt. Garfield and his 2d wife.

Benjamin Garfield Elizabeth Garfield.

- [18.] Strike out (?), m. Bethia Howe. This Benjamin was probably the Benj. G., who, with wife and two children, came to Wat. from Southboro, Sept., 1729.
- [19.] Benoni Garfield d. in Weston, Jan. 25, 1725. Mar. 2, 1719–20, Capt. Benjamin Garfield sold to his son Benoni, a house and 12 acres; also three other lots of 130 A. 3 A., and of 20 A.
- p. 234. [51.] Samuel Garfield was “a large athletic man, well recollected by many of our old people for his sallies of wit, feats of strength, and cheerful disposition.” [See Draper’s History of Spencer, p. 128.]
- [66.] Ensign Samuel Garfield was selectman of Wat., 1722, ’29.

p. 235. **GASKILL.**—For 1681, read 1687.

GEORGE.—See Goldstone, Part II.

p. 236. **GIBSON.**—Objections of the selectmen to James Gibson, 1st, not born in town; 2d, he came into town in order to a cure. [Court File, 1692.]

GILBERT.—Aug. 26, 1740, caution against (settlement of) wid. Mary Gilbert, from Brookfield, Sept., 1739. [See Bond, 192, also p. 688; also Thornton, 14.]

GIGGER.—May 20, 1755. Caution against (settlement of) Hannah Gigger, from Hanover. Ap. 3, 1758, caution of Newton, against (settlement of) Simon Gigger, negro man, and Hannah, his wife, from Wat., in February.

GLEASON.—[See Page, 2, on p. 383.]

- p. 237. **GODDARD.**—[1.] William Goddard, was selectman 1668, 69. July 8, 1674, William “Godheard,” of Wat., gentleman, and wife Elizabeth, sold to Richard Child, yeoman, about 50 acres, in Little Plain; bounded S. by Charles River; N. by cartway; E. by John Grout; W. by W. G.; Wit. Solomon Phipps, James Trowbridge. Admin. on estate of William Goddard was granted Nov. 3, 1691, to wid. Elizabeth, and son Robert. Inventory, by Henry Spring and Nathan Fiske, £70 5s.
- [4.] Jan. 12, 1709–10, Robert Goddard, of Wat., weaver, for £230 (? £23), bought of Nathaniel Hobart and wife Mary, of Hingham, 34 A., which land Hobart bought Feb. 6, 1707–8, of David Stowell (called 35 A.), bought by Stowell, of Hobart; bounded E. by Josiah Treadway and Caleb Church; S. by road; W. by Samuel Eddy, Elizabeth Woodward, Caleb Church, and Benjamin Wellington; N. by B. W. and S. E.
- p. 238. [14.] Joseph Goddard, of Brookline, was probably the father of Sarah Goddard, who m. in Rox., Oct. 20, 1715, Andrew Boardman.
- [16.] Joseph Goddard and Mary Bugbee, m. in Rox., May 29, 1716. Mr. John Stone, and Mrs. Mary Goddard, both of Rox., m. Oct. 23, 1729. Was this a d. of Joseph, Sen., or wid. of Joseph, Jr.?

- [18.] Robert, b. in Rox., Oct. 4, 1698. [19.] John, b. Oct. 4, 1699. [20.] Deborah, b. in Rox., June 19, 1698. [N.B., births, &c., in what is now Brookline, at that period, were recorded in Roxbury.] Where do they belong, or what are the affinities of the persons in the following Roxbury record?
- John Goddard, son of John and Sarah, b. in Rox., Feb. 14, 1714-15.
Elizabeth, dr. of John and Sarah, b. Feb. 17, 1716-17.
Mr. John Reed and Mrs. Hannah Goddard m. in Rox., Nov. 28 or 24, 1751.
- p. 239. [34.] James Goddard, a tailor, of Brookline, m., in Rox., Nov. 27, 1713, Mary Woodward. The birth of his dr. Sarah recorded in Roxbury.
- [46.] Robert Goddard, besides son Elisha, had the following children born, or births recorded, in Roxbury.
2. Mehitabel, b. Mar. 8, 1721.
 3. Mary, b. Mar. 1, 1725; (?) m. in Rox., Sept. 17, 1747, James Buckman, of Malden.
 4. Robert, b. Oct. 29, 1727.
- p. 241. [56.] See King, 3.
- p. 242. [62.] Charles Goddard m. (2d) Elizabeth Goddard [76-9]. Other chil., 2. Caroline. 3. Mary Louisa.
- [76-9.] Elizabeth m. Charles Goddard [62].
- p. 243. [79.] Nathaniel Goddard, Esq., d. in Boston, Aug. 6, 1853, aged 86. [See Geneal. Reg. VII., p. 375.]
- [82.] George Augustus Goddard m. Cornelia, dr. of Thomas Amory, of Milton.
- [84.] Mary Storer Goddard m. Henry Weld Fuller, Jr., Esq., of Boston, grad. Bowd. Coll. 1728, son of Henry Weld Fuller, Esq., of Augusta, Me., grad. Dart. Coll. 1801.
- [88.] Georgiana Goddard m. John A. Blanchard.
- [89.] Frederica W. Goddard m. William S., son of Rev. Dr. E—, of Boston.
- [92-2.] William Warren Goddard m. Harriet Irving.
- p. 246. [155.] James Goddard d. June 4, 1845. His son James d. Mar. 24, 1838.
- [155-2.] Thomas Austin Goddard, merchant, of Boston, m. Mary, dr. of Richard Frothingham, Esq. His sisters Rebecca and Matilda unm.
- [156.] John Goddard, of Camb., killed on a railroad, Feb. 4, 1853, aged 70.
- [158.] Chil. of Mary (Goddard) Kent. 1. John. 2. Mary. 3. Harriet. 4. Elizabeth. 5. Thomas Scott, d. 6. Samuel Davis.
- p. 253. [332.] See I. Stearns, App. I., 106.
- p. 254. [344.] See I. Stearns, App. I., 103.
- [357.] For Mercy, read Mary; and for [Stone, 24], read [Stone, 25].

- p. 256. **GODDING.**—[2.] Wid. Mary (Pease) Godding, d. Aug. 6, 1748.
- [4.] Sept. 9, 1766, caution against (settlement of) wid. Mary (? Mercy) Godding, from Camb., Dec., 1763.
- [6.] Sept. 11, 1764, caution against (settlement of) William Godding, Jr., wife Sarah, and chil. William and Sarah; also 2 other chil. of the Godding family, viz., Elizabeth Phillips, and Mary (?) Melhyrs, from Woburn, in April. He went to Newton, May, 1765.
- p. 257. [13.] After Elizabeth Holden, insert [13-5].

- GODFREY.**—Dea. WILLIAM GODFREY, of Hampton, d. Mar. 25, 1671, and his wid. MARGERY, m., Sept. 14, 1671, JOHN MARRIAN. [? Marion or Merriam.] Chil.,
1. John, m. in Hampton, May 6, 1659, Mary Cox.
 2. Isaac, b. in Wat., Ap. 15, 1639; m., July 15, 1670, Hannah Marrian. Sept. 29, 1699, Isaac Godfrey, of Hampton, for £11 10s., sold to Benjamin Harrington, of Wat., 53 A. in Wat. (Weston), bounded E. by Samuel Jennison; W. by Joseph Lovewell; N. by Josiah Jones; S. by Land of Contention.
 3. Sarah, b. in Wat., May 15, 1642; m., Aug. 18, 1670, John Clifford.
 4. Deborah, m., Dec. 5, 1667, John Taylor.
 5. A daughter, m. Thomas Webster.

- GOFFE.**—[See Hinman.] It is probable that Edward Goffe was the "brother Goffe," who embarked at Harwich, in Oct., 1634. [Young's Chron. Mass., p. 539.] John Goffe, of Hatfield, and Hannah Griggs, of Rox., m. Oct. 16, 1722.

GOLDSTONE.—[Such additional information has been obtained, and such errors of dates in the pedigree have been discovered since the printing of pages 105 and 6, that the whole account of the Goldstone family, as revised, is here inserted.]

The following Pedigree has been obtained from the records of Beddingfield and Wickham Skeith, villages of Suffolk, England.

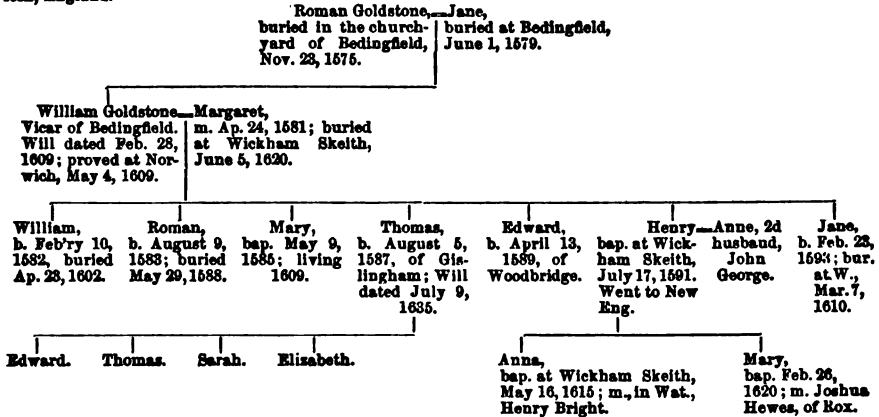

Henry Goldstone, aged 43, wife Anna, aged 45, dr. Anna, aged 18 years, and dr. Mary, aged 15 years, embarked at Ipswich, Eng., in Ap. 1634, and settled in Watertown, where he d. July 25, 1638, aged 46. In Nov. 1634, the Court "dismissed him training," by reason of age and infirmity, only he was to have in readiness at all times sufficient arms for himself, besides his servants. His wid. m. John George (of Watertown after this marriage), who d. about the 1st of June, 1647. His Inventory, by Lieut. Mason, John Coolidge, and John Sherman, was dated June 12, 1647. This Inventory was presented for probate by his wid. Anna, June 29, 1647, and on the same day she presented for probate "an inventory of all such goods [personal estate] as were widow Gouldstone's, and in her possession, before she entered into a married estate," £188 Os. 11d. She is called, "late wife of Henry Goldstone." She was appointed guardian of Robert and Susan George, two children of her last husband by a former wife.* This Susan George m. Robert Harrington [1]. [See General. Reg. VII., p. 172, and Suff. Prob. II., p. 33.] The items of the above-mentioned Inventory show, that Mr. Goldstone's house and farm were well furnished and stocked for that early day, and the schedule of his real estate (11 lots, one of which was a homestall of 28 A.), amounted to 355 acres. "Wid. Hannah [Anna] George," d. in Wat., Ap. 26, 1670, aged 79. Chil.,

1. ANNA, bap. at Wickham Skeith, Co. Suff., May 16, 1615; m. Dea. HENRY BRIGHT [1].
2. MARY, bap. Feb. 26, 1620 (probably not soon after birth, as she was 15 years old when she embarked), m. in Rox., Oct. 8, 1634, Lieut. JOSHUA HEWES. He, then unkm. came over about Sept. 1633, a fellow-passenger, it is believed, with Rev. John Cotton, Edmund Quincy, Col. John Leverett, Gov. John Haines, and Rev. Thomas Hooker. He was adm. freeman Mar. 4, 1633-4, and on the same day subscribed 20s. towards building the sea fort [Fort Independence]. He was Rep. at the Gen. Court, June 1641, and in Sept. 1642, the Court appointed him to have charge, in Rox., of the order respecting the making of saltpetre. He was a merchant of large transactions; was one of a free company of adventurers for trade and discoveries, incorporated by the Court in Mar. 1644, and in May, 1645, "Mr. Joshua Hewes" was one of the four undertakers for the iron-works. [See Col. Records, vol. II., Index, and Winthrop, II.,

* John George, of Charlestown, was one of the founders of the First Baptist Church in Boston. In Hutchinson's Hist. Coll. I., p. 399, see an account of the intolerant, shameful proceedings of the Court against him. He d. Sept. 12, 1666. His nuncupative Will mentions wife Elizabeth, and chil. Elizabeth Glazier, Martha Rose, John, Ruth, Hannah, and Mary. His wid. m. — Harbour; dr. Ruth m. in 1668, Samuel Frothingham; dr. Hannah m., Nov. 26, 1673, James Miller; dr. Mary m., July 11, 1678, Joseph Dowse. Whether this John was a son of that John George who d. in Wat. in 1647, has not been ascertained, but it is not improbable. Having attained his majority before the decease of his supposed father, he is not mentioned among the wards of wid. Anna.

Mar. 2, 1641. John George was put (by the Court) to Mr. John Winthrop, Sen., for 8 years, with his own consent. He was probably an orphan.

213.] He was one of the Rox. Grantees of land, between the lines of Ded., Wat., and Sudbury; was one of the messengers appointed by the Court, in 1648, to Shawomet (Warwick), in order to settle the disturbance there between the English and Indians; was engaged in the Narragansett purchase and settlement, and in 1662 moved thither, to Wickford (N. Kingston), but afterwards returned to Boston. His first marriage is the third recorded in Roxbury. His wife Mary (Goldstone) d., and he m. (2d) Feb. 11, 1657, ALICE, wid. of John Crabtree, of Boston. He d. in Boston, Jan. 25, 1676, aged 66. The births of only three of his chil. are recorded in Roxbury, but it is probable that he had others. Chil.,

1. *Joshua*, b. Oct. 19, d. Dec. 20, 1639. 2. *Mary*, b. Dec. 29, 1641.

3. *Joshua*, b. May 25, 1644. Joshua Hewes, probably this son, was appointed innholder, June 26, 1693, and d. in Boston in 1706.

GOLDTHWAITE.—Inventory of wid. Martha Goldthwaite, of Waltham, dated Dec. 3, lodged Dec. 4, 1783, £38 6s. 10d.

GOODRIDGE.—(Goodrich.) See Gutterig, in Part II.

GOSS.—For May 10, 163—, read 1631. John Goss, was a juror May 2, 1631. June 4, 1639, he was fined £20, for common railing [violating the gag-laws], and committed to prison. The fine was remitted not long afterwards.

GOVE.—The Will of John Gove, of Charlestown, dated Jan. 22, 1647–8, mentions wife (not named), whom he made ex'x; daughter Mary Gove, whom "I do give and bequeath, with my wife's full consent, to Ralph Mousal, and his wife, as their own child forever; and my two sons John and Edward." Inventory dated Jan. 25, 1647–8 (three days after the date of his Will), £9 12s. 6d. The Will renders it very improbable, that this Inventory embraced the whole of his estate. It is probable that he was a dealer or worker in brass. The disposal of his daughter, Mary, renders it probable that she was not the daughter of his wife, whom he appointed ex'x. He bought his house of "goodm. Larkin." [See General Reg. vii., p. 170.]

[1.] JOHN GOVE, was constable of Camb., in 1672; d. Nov. 24, 1704, aged 77. The record of his children requires to be corrected as follows:—

4. *Nathaniel*, bap. Nov. 16, 1662; d. soon.

5. *James*, bap. Dec. 13, 1663.

6. *Nathaniel*, bap. Aug. 4, 1667, mentioned in his father's Will; m. *Mary* —, and moved to Lebanon, Conn. [See General Reg. vii., 59.]

(By 2d wife.)

7. *Jonathan*, b. Jan. 19, 1677–8; d. Oct. 11, 1681.

8. *John*, b. about 1680; d. Jan. 16, 1681–2.

9. *Jonathan*, b. May 3, 1682.

10. *Sarah*, b. Aug. 28, 1686; m., Jan. 15, 1707–8, *Samuel Scot*, of Cambridge.

p. 260. **GRANT.**—[1.] After 1608, insert, or 10. Admin. on estate of Christopher Grant, was granted Oct. 6, 1685, to his sons Christopher, Caleb, and Joseph. Inventory by Henry Bright, John Biscoe, and Samuel Jennison, Oct. 5, 1685; house and about 19 acres, £100; 17 A. of mowing-land, butting on Camb. line, £50; 12 A. adjoining Fresh Pond; highway south; butting on Canal line, £36; 4 A. salt marsh N. side of Charles River, £21; 25 A. dividend land, bounded N. by Camb. line; S. by Slender Gut, £18; 3 A. in great meadow, £6; 12 A. in lieu of township, 1st division, £6; 12 A. in lieu of township, last division at Stoney Brook, £2 10s.; 7 A. farm-land nigh Concord Pond, £15; 71 A. farm-land, not far from Little Nonesuch, £30. His residence was towards the eastern border, not N.E. corner of the town. His homestead, of 5 acres, in 1644, was on the north side of the Cambridge road, opposite to Mount Auburn Cemetery. Jan. 19, 1691–2, Caleb, Christopher, and Joseph Grant, and their sisters Sarah Sevorns, and Mary Smith, state to the court that their father d. about 6 years since, intestate, that their mother is now deceased, and they pray for a division of the estate.

[2.] Feb. 5, 1699–1700, Roger Rose, of Dover, tailor, and wife Abigail, for £28 5s., sold to John Brewer, of Sud., 75 A. in Wat., 5th squadron of farm-land from Camb. line; land granted to William Guddridge (Goodridge).

- [3.] Estate of Joshua Grant, Jr., glazier, settled Mar. 5, 1694-5.
 [5.] Feb. 25, 1692-3, Benjamin Grant, weaver, and wife Priscilla, sold to Roger Rose, of Piscataqua, 2 lots in Wat., 17 acres. They probably, about this date, moved to Cambridge.
 [6.] Sarah Grant m. (1st), in Charlestown, Feb. 23, 1665-6, Samuel Seaverns [see Seaverns]. She m. (2d), as late as 1694, Thomas Sylvester, of Wat., q. v.
 [9.] If this Mercy was a dr. of Christopher Grant, she must have died early, s. p.; before the settlement of the father's estate.
 [10.] Adm. on the estate of C. G., granted to brother Joseph, Nov. 26, 1694.
 [11.] Mary Grant, wid. of Joseph, was living Mar. 1751, aged 84.
 [15.] Strike out this marriage, and see Joseph Grout, Jr., in Part II. JOSEPH GRANT, Jr., of Charlestown, m. SARAH —. She was adm. f. c. in Charlestown, Dec. 19, 1714. He d. Jan. 14, 1721-2, aged 31 y. 10 mos. His wid. Sarah, d. June 5, 1744, aged (?) 61 yrs. Chil.,
 1. Joseph, a mariner, of Charlestown, and Mary Parker, of Camb., m. in Charlestown, Oct. 3, 1745.
 2. Sarah, m., 1746, Daniel Lawrence, 3d. [7-3, G. Lawrence, Part II.]
 3. Margaret, bap. May 14, 1721.
 [16.] Stephen Grant and wife Abigail, had 9 chil. bap. in Charlestown. He was living in 1751.
 p. 261. [17-4.] Joshua, d. May 27, 1734. [17-6.] Lydia, d. Aug. 6, 1731.
 [20.] For Abraham Hill, read Abraham Watson.
 [22.] Strike out (?). [23.] Strike out (?).
 [24.] Strike out (?). Christopher Grant and Mercy Stratton m. (pub. in Boston, Nov. 1), 1739.
 [26.] Col. Christopher Grant m., Aug. 4, 1763, Sarah Watson, of Cambridge. He d. Ap. 1, 1818, and his wid. Sarah d. May 20, 1821, aged 75.
 [31.] Christopher, Jr., d. Mar. 12, 1850. Col. C. Grant was selectman 13 years, 1781-94.

GRAVES.—Benjamin Graves, fined 40s. for selling drink, was released by the selectmen from that part of the fine belonging to the poor, he being a poor man. At the same time (May, 1694) he was "approved as a retailer, he living in the woods, upon a road remote from any other ordinary several miles."

GREEN.—Winthrop [II., p. 152], says: "Divers families going from Watertown [in 1642-3], to plant Martha's Vineyard, procured a young man, one Mr. Green, a scholar, to be their minister, in hopes soon to gather a church there. He went not." It was Rev. Henry Green [not Thomas], an early proprietor of Wat., afterwards the first minister of Reading, who m. Frances, the eldest child of Dea. Simon Stone.* [Thomas Green, of Malden, m., Sept. 5, 1659, Frances, wid. of Richard Cook.]

Samuel Green was witness to a deed in Wat., Dec. 26, 1677. John Green was witness to a deed by wid. Jane Guy, in Sud., in 1666, and to a deed in Wat., Ap. 1671. He was an inhabitant of Wat. 1702 to 1714, where his wife, Bethia, d. Oct. 12, 1714, aged 68. [See Shattuck [12], Part II.]

p. 263. **GREGORY.**—[34.] The parentage of this Susan Upham is not ascertained.

GRIMES.—James Grimes had 3. Mary, b. in Newton, Ap. 25, 1747. 4. Kezia, b. in N., Sept. 28, 1749.

* Feb. 3, 1668, Simon Stone, Jr. (brother of Frances), and wife Mary, sold to Simon Coolidge a farm of about 55 acres, lately belonging to the relict and heirs of Henry Green, late of Watertown, clerk, to whom it was granted. This farm was in the western part of Watertown Farms (Weston), and very near or adjoining to the "Cowpen Farm." The Will of Dea. Simon Stone [General. Reg. III. 182] gives to his dr. Frances, £10, "And my mind is, that my daughter Frances' £10 should be paid £5 to Johnana Green, her daughter, and Nathaniel Green, her son, 50s. apiece: and the other £5 to the children she have by her husband —." By this, it appears that Mr. Green left only two children that lived to maturity, and that his wid. Frances m. a second husband, and had other children. It has not been ascertained what became of his dr. Joanna, or whether his son Nathaniel had wife or family. The son resided in Watertown as early as 1694, when he subscribed towards repairing the meeting-house. After this he appears to have become indigent or helpless. Mar. 16, 1708-9, wid. Mary Stone [6], presented a complaint to the selectmen that Nathaniel Green, an inhabitant of Wat., is destitute of a place of abode. Same date, the selectmen agreed to meet Ap. 1st next, to inquire, what estate of Green may be found in the possession of Mrs. Mary Stone. The next June, the selectmen desired Jabez Beers to take Nathaniel Green as far as he hath occasion, and the rest of the time to spend with Samuel Spur, at the shoemaker's trade. Jan. 30, 1709-10, the selectmen ordered the Treasurer to receive of the heirs of Simon Stone, deceased [6], payment on Green's estate; and on the 30th Jan. 1710-11, Simon Tainter agreed to keep Nathaniel Green 4 years from the 5th instant.

GROUT.—Capt. John Grout d. July 25, 1697. His dr. Mary b. Aug. 1, 1661. He left a handsome estate, apprizd Aug. 10, 1697.

Lands given to eldest son, John,	£260
Lands, mill, &c., rights, &c., given to son Jonathan,	150
[Jonathan m. Abigail Dix [10].]	
Lands, &c., to son Joseph, of Watertown,	160
Estate by Medup's, to son-in-law, John Livermore,	20
Money and meadow, to son-in-law, Joseph Curtis,	24
Lands to son-in-law, John Woodward,	24

Joseph Grout, Jr., of Wat., m., Jan. 3, 1716—17, wid. Mary Rogers. [See Harrington 53, Part II.] He had, 7. Daniel, bap. Ap. 4, 1736.

GROVER.—Thomas Grover, housewright, settled in Wat., previous to Dec. 1732, and he d. there Sept. 15, 1739.

GUTTERIG.*—(Gutteridge, Gudderidge, Gouteridge, Goodridge, Goodrich.) It is not clearly ascertained whether Goodridge, or Goodrich, is the correct orthography, as both of them are English names, and they have different coats of arms. Goodrick and Goodricke are also found in works of heraldry; and the coat of arms of Goodridge and Goodricke render it very probable that they are of the same origin.

The inventory of "William Goodrich," of Watertown, by Samuel Thatcher and Thomas Hastings, was dated Ap. 3, 1647 [See Geneal. Reg. VII., p. 57.]† His wid. Margaret m. John Hull, of Newbury, who d. there Feb. 1, 1670, and his wid. Margaret d. Feb. 3, 1683. His children went with their mother to Newbury, and all married there.

CHIL. OF WILLIAM AND MARGARET GOODRICH [GUTTERIG] OF WAT.

N.B. In the Newbury records the name is always written Goodridge. [Coffin, p. 303.]

1. MARY, supposed to be the eldest child; birth not recorded; born before their settlement in Watertown; m. in Newbury, Dec. 20, 1653, EDWARD WOODMAN, Jr.
2. JEREMIAH, b. in Wat., Mar. 6, 1637—8; m. in Newbury, Nov. 15, 1660, MARY ADAMS, (?) dr. of Robert and Eleanor. Chil.,
 1. Mary, b. Nov. 21, 1663; m., Ap. 21, 1684, Arthur Thresher.
 2. William, b. Aug. 2, 1665.
 3. Philip, b. Nov. 23, 1669; m., Ap. 16, 1700, Mehitabel Woodman, b. Sept. 1677, dr. of Joshua and Elizabeth (Stevens) Woodman, of Newbury. Lieut. Philip Goodridge d. in Lunenburg, Jan. 16, 1728—9, and his wid. Mehitabel d. there Feb. 24, 1755, aged 78. They had only 2 chil. b. in Newbury, viz.:
 1. Benjamin, b. Feb. 3, 1700—1.
 2. John, b. Aug. 2, 1702. Families of this name have been numerous in Lunenburg, probably descendants of Philip and Mehitabel.
 4. Elizabeth, b. Feb. 27, 1679.
 5. Hannah, b. Nov. 15, 1681; m., (?) 1703, Nathaniel Pettengale.
 6. John, b. May 26, 1685.
3. JOSEPH, b. in Wat., Sept. 29, 1639; m. in Newbury, Aug. 28, 1664, MARTHA MOORES. Chil.,
 1. Hannah, b. July 27, 1665; m., Mar. 22, 1694, John Richards, and d. Jan. 1695.
 2. John, b. Sept. 13, 1667; d. 1756, aged 89.
 3. Edmund, b. June 14, 1672; m., Nov. 16, 1702, Hannah Dole, and had 1. Edmund, b. Sept. 2, 1703.
 4. Abigail, b. Sept. 1675.
 5. Martha, b. Feb. 2, 1681.
 6. Margaret, b. Oct. 11, 1683.
 7. Joseph, b. Oct. 21, 1688.

* We offer the following conjecture, to be confirmed or confuted by future researches, viz.: that John and William Goodrich, (?) brothers, came to this country together from Bury St. Edmunds, or that vicinity, Co. Suffolk, England; that William, the younger, settled in Watertown, where he died; that John, the eldest of the two, was the John Guttering who was adm. freeman of Mass., May, 1642; that soon after this he went to Wethersfield, where his name appears in the Conn. Coll. Records the next year, taking with him his two sons, John and William (having left another son, William [See Note, p. 45], in England, to be educated, afterwards minister of Heggasitt, d. about 1677, s. p., bequeathing his estate to his nephews in Conn.); that he died on his return voyage to England, in 1644, leaving in Wethersfield those two sons, John and William, from whom the Goodrich families in Connecticut are descended.

† Colonial Records, June 6, 1637, "Whereas John Binfield dyed, leaving 2 children undisposed of, the charge of the one [Mary, who m. Samuel Garfield] was ordered to be defrayed by Mr. Cradock, he having the goods of the deceased, the other [Alice] being disposed of by the country" [to Emanuel White, q.v.]. It is probable that White d. soon, as his name disappeared, and, by the Gen. Court, Sept. 3, 1639, "William Guttridge was enjoined to take care of 'Ales Burwood,' until he may be lawfully discharged of her." [See p. 26.]

4. BENJAMIN, b. in Wat., Ap. 11, 1642; m., Sept. 8, 1663, MARY JORDAN. Chil.,
 1. *Joseph*, b. July 6, 1667.
 2. *Daniel*, b. Mar. 3, 1670; m., 1698, *Mary Ordway*.
 (By 2d wife, Deborah, who d. Nov. 8, 1676.)
 3. *John*, b. Jan. 1, 1674.
 (By 3d wife, Mary Croad, m., Nov. 16, 1678.)
 4. *Samuel*, b. Aug. 15, 1681.

[ANNA GOODRIDGE, mem. 2d church in Boston (her husband's name not given), had the following chil. baptized there: 1. *Anna*, bap. Mar. 27, 1698. 2. *Elizabeth*, bap. July 30, 1699. 3. *Walter*, bap. July 13, 1701; (? the Capt. Walter Goodridge, who m., in 1727, *Mary Bowles*, dr. of John Bowles, Esq. He d. soon, and his wid. m., Nov. 1, 1731, Hon. Benjamin Lynde, Jr., of Salem. See Bowles Pedigree.) 4. *Elizabeth*, bap. July 18, 1703. 5. *Thomas*, bap. Nov. 24, 1706. 6. *Mary*, bap. Nov. 2, 1707. 7. *Katherine*, bap. Mar. 23, 1712.]

- p. 264. GUY.—At Sudbury, June 25, 1666, Jane, wid. and ex'x of Nicholas Guy, late of Watertown, in consideration of the care and paine, charge and trouble of my daughter, Mary, and her husband, Henry Curtice, in entertaining me divers years past, and their engagement to do during my natural life; and in consideration of the constant service of their eldest son, Ephraim, and their other children, gives to Ephraim and his brethren, about 64 A. of land granted to her husband, Nicholas Guy; also sundry personal property enumerated to Ephraim, John, and Joseph, and to their father and mother, Henry and Mary. Wit. John Green, Thomas Steevens.

HACKLETON.—Inventory of Samuel Hackleton, of Wat., dated Ap. 17, 1773.

HACKETT.—Aug. 28, 1744, caution against (settlement of) Elizabeth Hackett, and her dr. Elizabeth, from Boston, Ap. 8.

HAGAR.—In the church records, Rev. Mr. Angier wrote this name Agar. Perhaps it will be ascertained that William Hagar, of Watertown, was a son of that William Agar, that was adm. freeman May 18, 1631. Both names are found in England, and their arms may indicate some early affinity, a lion being their chief characteristic.

- p. 264. [3.] For [Waite, 8], read [Waite, 16].
 [4.] For 1703-4, read 1704-5.
 [12.] The Will of Samuel Hagar, dated May 27, 1704, proved Mar. 8, 1704-5 (he d. Feb. 13, 1704-5), mentions wife, Sarah; chil. Isaac, Sarah, and Mary. Brother, Isaac Mixer, and son Samuel, ex'rs. Capt. B. Garfield, and Abraham Brown, overseers. Wit. B. Garfield, Munning Sawin, Edward Goddard; Inventory, £176 16s.
 p. 266. [65.] William Hagar, and wife Mary, dismissed from Waltham to Weston, May 10, 1741.

- p. 269. HALL.—Christopher Hall, who had worked in Watertown, wit. in court June, 1680, then aged 44. Dec. 13, 1763, Lincoln cautions against (settlement of) Kate Hall, from Wat., June, 1762.

HALSTEAD.—The Inventory of Nathan Halstead, late of Concord, deceased, dated 5, 12, 1643, £213 13s. 2d. Was he a relative of Susan Halstead, of Watertown? [See Shattuck, p. 372; and see p. 686.]

HAMMOND.—In 2d line, for two brothers, read two persons.

- [†1.] For Cavenham, read Lavenham.
 [†13.] For 1587, read 1583. [†14.] For 1686, read 1586.
 [†15.] There is no satisfactory evidence that this is the Thomas Hammond, who settled first in Hingham, and afterwards in Newton, but it is very probable. [See [1.] next page.]
 [1.] Sarah, dr. of Wm. Hammond, had a son Adam Smith. [See p. 441.]
 p. 270. [2.] Copy of paper on files of court, dated Ap. 14, 1648. "I, Edmund Shearman, of Dedham, clothier, do adventure by sea, 2 broadcloths, by Thomas Hammond, of New England, planter," signed by both. Ap. 8, 1660, Edmund Sherman, and Henry Wright, of Dedham, Co. Essex, make John [Sherman], pastor of, &c., his (their)

attorney. Wit. Bazal Angier, and Nath. Backster. Sept. 29, 1663, (Rev.) John Sherman, att'y of Edmund, of Dedham, England, commenced a suit against Livermore and Steadman, assignees of Thomas Hammond. June 21, 1659, William Waynes, and John Parker, indifferent persons, were appointed by the court to determine the controversies among the heirs of Thomas Hammond.

- [8.] For two wives, read three wives, and as follows. He m. (1st) Abigail —, who was the mother of John, Elizabeth, John, and Abigail. He m. (2d) Sarah —, the mother of his other children; she d. Jan. 14, 1688, aged 45. He m. (3d) Prudence —, who d. a wid. Sept. 1711, aged 74. The births of John 2d, and Hepzibah, are not recorded. John was probably a son of Abigail, and Hepzibah was a dr. of Sarah. Lieut. John Hammond was selectman 1664, 70, 92, 98, 1701. His Will, dated Nov. 18, 1709, mentions wife Prudence, son John, dr. Elizabeth Mason, dr. Abigail Hastings, dr. Hannah Poulter, dr. Hepzibah Shattuck; sons-in-law, John Mason, John Hastings, John Poulter, and William Shattuck; Sarah Barnard, maid-servant.
- [9.] For Mar., read May.
- [14.] For 1677, read 1678. Thomas Hammond was selectman 1693, 94, 99.
- [15.] Hannah, d. Jan. 13, 1691-2.
- p. 271. [20.] Thomas Hammond, Jr., selectman of Wat. 1730, 31, 32.
- [29.] SAMUEL HAMMOND, by wife ANNA, had, in Lunenburg, 1. *Avis*, b. Ap. 3, 1753; (? m. in Wat., Dec. 5, 1771, *Nehemiah Munroe*, of Lex., and settled in Rox.
2. *Anne*, b. in L., Sept. 28, 1754. 3. *Samuel*, b. in L., July 25, 1756.
4. *Phineas*, b. in L., Sept. 11, 1758. [See *Locke Fam.*, p. 309.]
- [37.] The nuncupative Will of Ebenezer Hammond, dated May 14, 1760.
- [49-1.] Betsey, m. — Richards, of Cambridgeport, d. Several chil.
- [49-3.] Sophia, m. Nathaniel Stearns, of Waltham. [I. Stearns, 242, V.]
- [49-4.] William, m., and resides in Dorchester.
- [49-5.] Jonathan, m., and resides in Dorchester.
- [49-6.] Lydia, m. — Fletcher, of Littleton.

THOMAS HAMMOND.

- 1 (I.) THOMAS HAMMOND, settled in Hingham, as early as 1636, was adm. freeman Mar. 9, 1636-7, and was a grand juror Sept. 19, 1637. In 1650, and again in 1656, he sold lands in Hingham. In 1650, he purchased land in Cambridge Village (Newton), near the boundary line of Brookline, and near a beautiful body of water, which has since borne his name—"Hammond Pond." Nov. 14, 1656, for £40, he purchased of Esther, dr. of Nathaniel Sparhawk, of Cambridge, 300 A. of land in said town, on the south side of Charles River, bounded N., S., and W. by a farm granted by the town to Robert Bradish (partly now in the possession of wid. Hammond), N. by land now of John Ward, and Thomas Prentice, formerly granted to Elder Frost; E. by Mr. Hibbin's land. His wife, ELIZABETH, died first, and he d. Sept. 30, 1675, leaving two sons, Thomas and Nathaniel, and two daughters, Elizabeth and Sarah, all mentioned in his Will. To his drs. he gave lands in Brookline ("Muddy River"). Inventory, £1139 16s. 2d. There is no clear evidence that he and William Hammond, of Watertown, were kinsmen; but it is very probable. It is supposed that he came from Lavenham, Co. Suffolk, England, whence it is known that William Hammond, of Wat., came; and that he was the Thomas Hammond who m., in Lavenham, Nov. 12, 1623, Elizabeth Cason.
6. 2 1. THOMAS, m., in 1662, ELIZABETH STEDMAN; d. 1678.
- 3 2. ELIZABETH, m., Aug. 7, 1659, GEORGE WOODWARD, of Wat., his 2d wife. 5 chil. [Woodward, 2]. He d. May 31, 1676. She m. (2d) Samuel Truesdale, Senr.
- 4 3. SARAH, bap. in Hingham, Sept. 13, 1640; m. — STEADMAN. She d. before her father (1675), leaving two drs., Sarah and Elizabeth.
19. 5 4. NATHANIEL, bap. in Hingham, Mar. 12, 1643; d. 1691, aged 48 [gravestone].
2. 6 (II.) THOMAS HAMMOND, Jr., m., Dec. 17, 1662, ELIZABETH STEDMAN. He d. of small-pox, Oct. 20, 1678, and admin. was granted to his widow, who d. 1715. Dec. 18, 1683, his sons Thomas and Isaac chose their uncle, Nathaniel H., for their guardian; James Trowbridge and Thomas Greenwood, with wid. Elizabeth Hammond, guardians of the three younger children. Chil.,

- 7 1. ELIZABETH, b. May 9, 1664; m., Ap. 18, 1682, THOMAS CHAMBERLIN. Her death is not recorded, but it is supposed that he (T. C.) is the one who m., in Concord, Jan. 9, 1690, ELIZABETH HALL. He d. 1724. The Inventory of his wid. Elizabeth (2d wife), was dated Feb. 19, 1732-3; Wm. Ireland, admin'r. Chil.,
- 8 1. *Thomas*, b. in Camb., Sept. 10, 1683; m. in Wat., June 22, 1709, *Sarah Mason*. [12.] He d. before 1720 (probably s. p.), when his wid. had become the wife of John Bond. [98.]
- 9 2. *Elizabeth*, b. in C., Aug. 1, 1686; m., 1717, *George Allen*.
- 10 3. *Rebecca*, b. Mar. 11, 1688-9.
[Chil. of T. C., by his supposed 2d wife; if so, not of the Hammond family.]
- 11 4. *Mary*, b. Feb. 11, 1693; m., Feb. 11, 1716-17, *Isaac Hammond*. [39.]
- 12 5. *Sarah*, b. Feb. 19, 1695; d. before 1756; m., Dec. 17, 1730, *Eleazer Chamberlin*, of Brookline. Chil., 1. *Elizabeth*, b. Mar. 30, 1736; m. in 1756, Ebenezer Thwing, of Camb 2. *John*, b. Feb. 9, 1739; d. 1749.
- 13 6. *John*, b. Sept. 26, 1698, by wife *Elizabeth*, had 1. *John*, b. Mar. 28, 1721.
26. 14 2. THOMAS, b. Dec. 16, 1666.
37. 15 3. ISAAC, b. Dec. 20, 1668. 4. SARAH (twin), b. Dec. 20, 1668.
- 16 5. NATHANIEL, b. Feb. 3, 1670-1.
- 17 6. JOHN, b. Ap. 30, 1674.
48. 18 7. ELEAZER, b. Nov. 13, 1677.
-
5. 19 (II.) NATHANIEL HAMMOND, m., about 1671 or 2, MARY —. [She is said to have been a dr. of Jonathan and Mary (French) Hyde; but I find no dr. Mary, recorded among the 21 children of Jonathan Hyde. Perhaps she was his eldest child, whose birth was not recorded; but this is improbable.] He d. May 29, 1691, aged 48 [gravestone], and admin. granted to his wid. Mary, Oct. 6, 1691. Inventory, £396 18.
May 6, 1702, Nathaniel and Thomas Hammond, Samuel Truesdale, and Elizabeth, his wife; Samuel Prentice, and Esther, his wife; Mary and Sarah Hammond, chil. of Nathaniel Hammond, of Newton, agreed that the share of their sister, Hannah, who d. in her minority, should go to their brother Thomas. In this agreement is mentioned "Mary Williams, their mother, wid. of their father Nathaniel." She became the 2d wife of Capt. Isaac Williams, of Newton.
- 20 1. MARY, b. Dec. 15, 1672, unm. in 1702. 2. SARAH, b. Oct. 3, 1675, unm. in 1702.
72. 22 3. NATHANIEL, b. July 26, 1678.
- 23 4. ELIZABETH, b. Mar. 11, 1682-3; d. before 1730; m. SAMUEL TRUESDALE, Jr. Chil.,
1. *Hannah*, b. Mar. 18, 1706.
2. *Elizabeth*, b. Mar. 12, 1709; m., 1733, *Samuel Eddy*. [See p. 755].
3. *Esther*, b. Ap. 30, 1711.
4. *Thomas*, b. Dec. 14, 1714; m., in 1739, *Elizabeth*, dr. of Job Seger.
5. *Mary*, b. July 22, 1717. 6. *Sarah*, b. Aug. 23, 1721.
7. *Rebecca*, b. Mar. 21, 1725.
- 24 5. ESTHER, m., about 1701, SAMUEL PRENTICE, son of Thomas Prentice, Jr., and wife Sarah, and grandson of Capt. Thomas, and wife Grace, of Newton, and moved to Stonington, Conn. 4 sons and 5 drs. and numerous distinguished descendants. [See Prentice Family, p. 184.]
82. 25 6. THOMAS, b. Feb. 27, 1686.
7. HANNAH, b. Mar. 31, 1689, d. Sept. 20, 1700.
-
14. 26 (III.) THOMAS HAMMOND m. (1st), MEHITABEL —. She d. 1704, aged 39, and he m. (2d), in Rox., Aug. 8, 1705, MARY BACON. He d. Mar. 15, 1738, aged 72. Chil.,
- 27 1. MEHITABEL, b. Jan. 29, 1695.
97. 28 2. JOHN, b. Mar. 16, 1696.
- 29 3. THOMAS, b. July 10, 1698; m., Ap. 10, 1634, ANN FARLEY. Had he a family?
- 30 4. CALEB, b. July 4, 1700.
(By 2d wife.)
- 31 5. MARY, b. Feb. 13, 1707; m., Nov. 28, 1723, SAMUEL BENJAMIN [60].
- 32 6. SAMUEL, b. July 9, 1709; m. EUNICE —. He d. Oct. 1736, aged 27, and his wid. Eunice m. 1746, Robert Prentice, his 2d wife. Chil.,

- 33 1. *Eunice*, b. Jan. 14, 1733. 2. *Mary*, b. Oct. 4, 1734.
- 34 3. *Isaiah*, b. Nov. 13, 1735; m., 1763, *Lydia Healy*, b. June 29, 1741, dr. of John and Hannah, of Newton, and gr. dr. of Nathaniel.
- 35 1. Samuel, b. Jan. 1, 1765.
- 36 2. David, b. May 28, 1766; m. 1789, Mary Hyde.
- 36½ 3. Jeremiah, b. Aug. 20, 1772.
-
15. 37 (III.) ISAAC HAMMOND, of Newton, m., Dec. 7, 1692, ANN KENRICK, b. July 3, 1672, dr. of Elijah and Hannah (Jackson) K., of Newton. He d. Jan. 1, 1715. His wid., Ann, left a Will, dated 1719.
- 38 1. MARGARET, b. Aug. 25, 1694; m., in 1737, JOSEPH CHENEY.
- 39 2. ISAAC, b. July 31, 1698; m., Feb. 11, 1716-17, MARY CHAMBERLIN, dr. of Thomas and Elizabeth C., of Newton. He purchased land in Newton of his father, Isaac Hammond, and his wife Ann. He moved to New London, Conn., where his son Noah became a Baptist preacher. [Caulkins, p. 611.]
- 40 1. Noah, b. Feb. 14, 1718. 2. Amariah, b. Ap. 18, 1719.
- 40 3. Jason, b. June 16, 1720.
- 43 3. JOSIAH, b. 1700. 4. HANNAH, b. Ap. 19, 1703.
- 45 5. JONATHAN, b. Feb., 1704-5.
- 46 6. ESTHER, b. Feb. 3, 1708 (?); m., Mar. 23, 1727, SAMUEL CHAMBERLIN.
- 47 7. ELIJAH, b. Oct. 7, 1711.
-
18. 48 (III.) ELEAZER HAMMOND, of Newton, m., in Wat., Ap. 29, 1703, HANNAH HARRINGTON [Harrington, 16]. The Will of his wid. Hannah, dated Ap. 4, 1764, mentions son Ephraim, drs. Patience Chamberlin, Hannah Green, Abigail Harrington, Susanna Fulham, Lydia Hammond, and gr. dr. Lydia Hammond. [Was this grandchild, Lydia, a child of her son Eleazer, or of her dr. Lydia ?]
- 49 1. HANNAH, birth not recorded, probably the eldest child; m., Nov. 9, 1724, BARTHOLOMEW GREEN.
- 50 2. ELEAZER, b. Oct. 1, 1705, d. soon.
- 51 3. ELIZABETH, b. Jan. 12, 1707; not mentioned in her mother's Will.
- 51 4. ELEAZER, b. May 26, 1711; not mentioned in his mother's Will.
- 52 5. ABIGAIL, b. Jan. 31, 1712-13; m., Oct. 28, 1731, her cousin, RICHARD HARRINGTON, of Lex. [Harrington, 291.]
- 53 6. PATIENCE, b. Sept. 8, 1717; m., Ap. 30, 1761, ELEAZER CHAMBERLIN, his 3d wife.
- 54 7. EPHRAIM, b. Mar. 13, 1720, of Newton; m., Dec. 10, 1741, MARTHA STEEL. He d. 1775, and she d. 1771. Chil.,
- 55 1. *Hannah*, b. Aug. 8, 1742; d. early.
- 56 2. *Martha*, b. Dec. 9, 1743; "Pattee" d. Jan. 8, 1832, aged 88, unm.
- 57 3. *Ephraim*, b. Dec. 31, 1745; m., Mar. 24, 1768, *Sarah Parker*. Chil.,
- 58 1. *Hannah*, b. Oct. 12, 1768.
- 59 4. *Thankful* (twin), b. Dec. 31, 1745.
- 60 5. *Samuel*, b. Feb. 2, 1748; m., Nov. 8, 1770, *Mary Rodgers*. Chil.,
- 60 1. Samuel, b. May 25, 1772. 2. Peter, b. Ap. 9, 1776.
- 62 3. Joel, b. July 10, 1778. 4. Artemas, b. Ap. 3, 1782.
- 64 5. Nathaniel, b. Aug. 14, 1784, a carpenter, of Boston.
- 65 6. *Hannah*, b. Sept. 20, 1749. 7. *Edward*, b. Sept. 20, 1752.
- 67 8. *Catherine* (twin), b. Sept. 20, 1752. 9. *Henry*, b. July 27, 1757.
- 69 10. *Patience*, m., 1778, *Nathaniel Parker, Jr.*
- 69½ 11. *Elizabeth*, m. 1777, *Jonathan Bizby*. 12. *Jemima*.
- 70 8. SUSANNA, m., Dec. 4, 1740, FRANCIS FULHAM, Jr., of Weston [3].
- 71 9. LYDIA, m., May, 1745, JOHN HAMMOND, Jr. [98].
-
22. 72 (III.) NATHANIEL HAMMOND, of Newton, m. (1st), MARY HYDE, b. Feb. 7, 1684-5, dr. of John, and gr. dr. of Jonathan Hyde, Sen. She d. Feb. 7, 1710, and he m. (2d) Jan. 31, 1711, MARGARET STONE, b. Aug. 1, 1688, dr. of Hon. Ebenezer Stone, of Newton [Stone, 50]. He d. Ap. 4, 1749, aged 70, and his wid. m. Ebenezer Woodward [73]. She d. 1776, aged 88.
- 73 1. NATHANIEL, b. Nov. 9, 1707; m., Ap. 15, 1734, SARAH FARLEY, settled in Stoughton. He d. 1770, and admin. granted to wid. Sarah.

2. BENJAMIN, b. July 9, 1709; d. same year.
(By 2d wife, Margaret.)
- 74 3. JONAS, b. Nov. 11, 1711; m., Nov. 1, 1739, ELIZABETH MILLER, and settled in Charlton.
4. JAMES, b. Jan. 24, 1713, d. Jan. 17, 1715.
- 75 5. EBENEZER, b. Sept. 19, 1714; m., Nov. 1743, his cousin, ESTHER STONE [53], and settled in Charlton.
- 76 6. MARGARET, b. Mar. 4, 1716; (?) m., Nov. 30, 1737, JOSEPH CHENEY.
7. MARY, b. Nov. 5, 1717, d. Jan. 11, 1726.
- 77 8. KEZIA, b. Jan. 23, 1719; m., Feb. 17, 1743, TIMOTHY PARKER, who settled in Holliston.
9. JAMES, b. Nov. 14, 1721, d. May 8, 1724.
141. 78 10. BENJAMIN, b. June 7, 1724.
- 79 11. ELINOR, b. Jan. 12, 1725-6; m., Jan. 7, 1748, JONATHAN FULLER. [68, Part II.]
12. MARY, b. Aug. 1, 1727, d. Aug. 18, 1729.
- 79½ 13. MARY, b. Oct. 23, 1730 (?); m., in Wat., June 15, 1756, MOSES BIGELOW.
- 80 14. MERCY, b. 1732, d. Oct. 17, 1749.
- 81 15. DAVID, b. Aug. 10, 1733; m. REBECCA, dr. of Dr. James Ormes, of Spencer. [See Ormes.] He settled in Charlton.
-
25. 82 (III.) Lieut. THOMAS HAMMOND, of Newton, m. (1st), in Rox., Dec. 30, 1714, SARAH GRIFFIN. She d. Sept. 30, 1732. He m. (2d), May 23, 1734, ANN LONGLEY. He d. Mar. 15, 1753, and his wid. Ann d. 1758, aged 51. His Will, proved 1753, mentions one son, Joseph, and 6 drs.
-
- 82½ 1. SARAH, b. Oct. 16, 1715; m., 1739, JOSIAH PARKER.
- 83 2. JOSEPH, b. Ap. 15, 1717; m., Ap. 3, 1744, MARY GORE, of Rox. He d. 1786, and she d. Mar. 1, 1786. Chil.,
- 84 *1. Thomas, b. Nov. 12, 1744. 2. Mary, b. Mar. 10, 1746; m., 1777, Isaac Jackson, Jr.
- 86 3. Sarah, b. Sept. 7, 1747; m. Norman Clark, Jr. 4. Rebecca, b. Dec. 14, 1748.
- 88 5. Ann, b. Feb. 25, 1750.
3. ELIZABETH, b. Feb. 14, 1719, d. young.
- 89 4. EUNICE, b. Ap. 27, 1721; m., Sept. 3, 1741, THOMAS PARKER, and d. 1812.
- 90 5. MARTHA (twin), b. Ap. 27, 1721; m. 1749, JOHN SHATTUCK [27-8].
6. HANNAH, b. Ap. 26, 1723, d. July 29, 1725.
- 91 7. HANNAH, b. 1726.
- 92 8. ESTHER, b. Aug. 29, 1728; m., Oct. 18, 1750, THOMAS GREENWOOD, of Holden.
9. MOSES, b. Jan. 23, 1731; d. May 12, 1741.
(By 2d wife, Ann.)
- 93 10. AARON, b. Jan. 9, 1735. 11. BENJAMIN, b. Aug. 17, 1737.
- 95 12. ANN, b. June 5, 1741. 13. ELIZABETH, b. June 15, 1745.
-
28. 97 (IV.) JOHN HAMMOND, of Newton, m., Dec. 8 (or 11), 1718, MARGARET WILSON, b. Aug. 28, 1699, dr. of Samuel and Experience (Trowbridge) Wilson, of Newton. He d. in 1763.
-
- 98 1. JOHN, b. July 25, 1719; m., 1745, LYDIA HAMMOND [71].
- 99 1. Lydia, b. June 17, 1746; (?) m., Ap. 4, 1765, Benjamin Cook.
- 100 2. Elizabeth, b. June 16, 1749.
- 101 2. JOSHUA, b. Mar. 10, 1721; m., May 15, 1739, ELIZABETH PRENTICE, b. Aug. 26, 1714, dr. of Capt. Thomas and Elizabeth Jackson Prentice, of Newton. "She is said to have been one of the most virtuous and accomplished women of the town." [See Prentice Family, p. 164.] He d. 1792, aged 72, and his wid. d. 1798, aged 84. They had only one child, viz.,
162. 162 1. William, b. July 15, 1740; a Capt., of Newton, moved to Bangor, Me.
3. THOMAS, b. Ap. 23, 1723; d. Feb. 26, 1728. 4. MARY, (twin), b. Oct. 7, 1725.
- 103 5. MARGARET, b. Oct. 7, 1725; m., May 15, 1746, ROBERT PRENTICE; and in 1751, THOMAS MAREAN.
- 104 6. DANIEL, b. Oct. 18, 1727; m., Ap. 17, 1751, LUCY JONES. Chil.,
- 105 1. Lucy, b. July 25, 1752. 2. Thomas, b. June 6, 1753; d. July 31, 1763.
- 106 3. Phineas, b. June 4, 1755. 4. Beulah, b. May 11, 1757.

- 108 5. *Thomas*, b. Feb. 20, 1762; (?) m., Nov. 2, 1788, *Sarah Winchester*, of Brookline. [N.B. This family left Newton, and joined the Shakers in Harvard, Mass.] Chil.,
- 109 1. *Joseph*, b. June 23, 1789. 2. *Thomas*, b. Aug. 8, 1791.
- 111 3. *Sarah*, b. Sept. 30, 1793. 4. *Mary*, b. Sept. 22, 1795.
- 113 5. *Lucy*, b. July 2, 1797. 6. *Moses Winchester*, b. June 6, 1799.
- 115 7. *Elnathan Winchester*, b. May 6, 1802. 8. *Benj. Franklin*, b. Oct. 29, 1803.
- 117 9. *Charles*, b. June 22, 1805.
- 118 6. *Ann*, b. June 28, 1764. 7. *Sarah*, b. Dec. 19, 1766.
- 120 6. SAMUEL, b. June 14, 1730; m., Mar. 13, 175—, MARY FISKE, of Waltham. [J. Fiske, 52.] She d. 1770. Chil.,
- 121 1. *Mary*, b. May 5, 1755; m. *Ebenezer Fairbanks*, of Dedham, and d. 1843.
- 122 2. *Rebecca*, b. Jan. 17, 1757; d. 1845; m., Mar. 18, 1779, *Ephraim Traine*, his 2d wife. [Traine, 35.]
- 123 3. *Samuel*, b. Sept. 30, 1758; d. 1780.
- 123 4. *Jonathan*, b. Nov. 21, 1761; m., Mar. 18, 1790, *Beulah Hyde*, and had dr. *Julia*, who m. — Crane.
- 124 5. *Margaret*, b. Ap. 1, 1764; m., Ap. 30, 1794, Capt. *John Pritchard*. 1 dr. *Lucy*, d. Jan. 20, 1823; and she d. Jan. 23, 1846.
176. 125 6. *Asa*, b. July 12, 1766, name changed to Samuel, after the decease of his brother Samuel. He settled in Boston.
- 126 7. ABIAH, b. Nov. 5, 1732; m., in Wat., June 5, 1755, MARY SALTMARSH, bap. in Charlestown, June 6, 1731, eldest child of Thomas and Mary Saltmarsh, of Wat., whither he moved in 1760. Chil.,
- 127 1. *Abijah*, b. Feb. 22, 1757; was a Colonel in the U. S. Army, and d. at West Chester, N. Y. He m. — *Ogden*, of N. York, and left two sons, Charles and Ogden.
- 130 2. *Martha*. 3. *Isaac*, bap. in Wat., July 17, 1763. 4. *Mary*. 5. *George*.
- 132 6. *Abigail*, all bap. in Wat., Mar. 4, 1770.
- 133 8. ENOCH, b. Oct. 29, 1734; m., May 10, 1764, LUCY FISKE, of Waltham. [J. Fiske, 92.] Chil.,
- 134 1. *Lucy*, b. Ap. 17, 1765. 2. *Lucy*, b. Dec. 24, 1766.
- 135 3. *Enoch*, b. Ap. 7, 1768. 4. *Samuel*, b. Aug. 16, 1770.
- 137 5. *Jeremiah*, b. Aug. 20, 1772. 6. *Artemas*, b. Jan. 1, 1775.
- 139 7. *Charles*, b. Mar. 3, 1777.
- 140 9. ANN, b. Sept. 23, 1736; m., 1758, GULLIVER WINCHESTER, b. Mar. 4, 1733, son of Stephen and Hannah, of Newton. She d. in Brookline, 1797; and he d. there Nov., 1811. Chil.,
1. *Elizabeth*, b. Feb. 13, 1759; m. *Edward Mitchell*, of Newton.
2. *Henry*, b. Aug. 10, 1761; a schoolmaster; d. in 1801, unm.
3. *Anna*, b. July 26, 1762; m. *James Foster*.
4. *William*, b. June 25, 1765; m. *Anna Fuller*, in 1800, and settled in Rox.
5. *Mary*, b. Oct. 28, 1767; m. *John Durell*.
6. *Susanna*, b. May 15, 1769; m. *Abijah Seaverns*, of Rox.
7. *Artemas*, b. Aug. 7, 1770; d. 1812, unm.
8. *Lucretia*, b. Aug. 13, 1773; m. *Jabez Lewis*, of Rox.
10. MARTHA, b. Ap. 10, 1738; d. Oct. 12, 1757.
- 140 11. ABIGAIL, b. 1741; m., Feb., 1764, Lieut. JOHN MAREAN, commander of a Co. of minute men, in the Battle of Concord; 8 chil. He d. 1786, and his wid. m. 1789, Capt. EDWARD FULLER. She d. May, 1826, aged 85.
-
78. 141 (IV.) Col. BENJAMIN HAMMOND, of Newton, is said to have commanded a company of militia at Lexington, Ap. 17, 1775, and did other military duty during the Revolution. He afterwards obtained the rank of Colonel, and, for a long time, was a leading man in the municipal affairs of Newton. He m., Oct. 5, 1749, SARAH BROWN [52], of Waltham, dr. of Dea. William and Sarah (Bond) Brown. She d. Mar. 19, 1800, aged 75. In advanced age he went to Rutland, to reside with his dr. Abigail. Chil.,
- 142 1. NATHANIEL, b. May 22, 1750; d. Jan. 31, 1752.
2. EBENEZER (twin), b. May 22, 1750.

- 143 3. SARAH, b. Nov. 30, 1751; m., 1769, Capt. NORMAN CLARK, of Newton, and a few years afterwards moved to Princeton, Mass.
- 144 4. ANNA, b. Dec. 16, 1754; m., Oct. 9, 1777, Rev. JOSEPH POPE, b. in Brookline (then a part of Pomfret), Conn., Sept. 28, 1746; grad. Harv. Coll. 1770; ordained in Spencer, Mass., Oct. 20, 1773. He d. Mar. 8, 1826, and his wid. now (1855) survives, in her 101st year, occupying the same chamber she has done more than 70 years. [See History of Spencer.] Chil.,
- 145 1. Joseph, b. July 14, 1778, grad. Dart. Coll. 1798; a lawyer, of Portland, where he m. (1st) Jan. 1811, *Caroline McLellan*, b. May, 1793, dr. of Major Hugh McLellan, a distinguished merchant, of Portland. She d. Dec. 4, 1817. He m. (2d), July, 1821, *Hannah Wakefield*, b. 1798, who d. May 19, 1828. He m. (3d) Oct. 29, 1832, *Harriet M. Jones*, b. Ap. 10, 1801, sister of T. R. Jones, Esq., of Portland. Mr. Pope d. Ap. 1852. Chil.,
- 146 1. Ann Jane, b. Dec. 1, 1811; m., Feb. 22, 1836, Samuel H. Pennington, M.D., b. Oct. 16, 1806, of Newark, N. J. Chil.,
1. Samuel H., b. June 13, 1837, d. Aug. 1838.
2. Sarah Caroline, b. Dec. 25, 1838. 3. Anna Pope, b. Ap. 4, 1840.
4. Samuel H., b. Mar. 9, 1842. 5. Joseph Pope, b. Jan. 27, 1845.
6. John C., b. Oct. 12, 1850.
- 147 2. Harriet T., b. Aug. 31, 1813; m., Nov. 5, 1839, Rev. Calvin E. Park, of Foxford, Mass., b. in Providence, R. I., Dec. 30, 1811, son of Rev. Calvin E. Park, D.D., Prof. in Brown University. Chil.,
1. Anna Pope, b. Sept. 18, 1842. 2. Charles Ware, b. Sept. 8, 1845.
3. Caroline McLellan, b. July 23, 1847.
4. William Pope, b. Aug. 4, 1853.
3. Charles, b. Dec. 6, 1815, d. June 1816.
4. Edward Charles, b. May 1817, d. Aug. 1820.
(By 2d wife, Hannah.)
- 148 5. Joseph, b. Dec. 25, 1822. 6. Lucretia Howe, b. Ap. 1823, d. Mar. 1824.
7. Hannah, b. Ap. 1827, d. June, 1828.
(By 3d wife, Harriet M.)
- 148} 8. Caroline Eliza, b. Oct. 5, 1833.
- 149 2. Charles, b. Feb. 26, 1780; d. at Thomaston, Me., in 1842, unm.
- 150 3. William, b. Dec. 10, 1781; a Justice of the Peace, of Spencer, occupying the paternal homestead. In early life, he resided sometime at Thomaston, Me. He m. (1st), *Eliza Prince*, dr. of Hezekiah Prince, Esq. of Thomaston. He m. (2d), *Elizabeth Stearns*, dr. of the late Charles Stearns, of Worcester, He m. (3d), Mrs. *Experience (White) Clapp*, wid. of Geo. W. Clapp, and a native of Spencer. He is now a widower. Chil.,
- 151 1. Ann Eliza, b. Nov. 12, 1818; m., Ap. 16, 1840, Rawson Vaile, grad. Amh. Coll. 1839, and settled in Indianapolis, Ia., where he is co-editor and proprietor of the Indiana State Journal. She d. in 1853. Chil.,
1. William P. 2. Sarah Lucretia. 3. Joel Frederick. 4. Joseph Edward. 5. Charles Selden.
2. Isabella Prince, b. Dec. 17, 1820, d. May 31, 1821.
- 152 3. Joseph, b. Aug. 16, 1822, unm.
- 153 4. Lucretia Howe, b. Sept. 17, 1824; m., June 23, 1853, William Upham, a manufacturer, of Spencer.
- 154 5. Sarah Augusta, b. Jan. 17, 1827.
(By 2d wife, Elizabeth.)
- 155 6. Maria Isabella, b. Jan. 27, 1831.
- 156 4. Anna, b. Feb. 16, 1786; m., Sept. 1810, Rev. *Roswell Shurtleff*, D.D.; b. Aug. 29, 1773, youngest son of William and Hannah (Cady) Shurtleff,* grad. Dart. Coll. 1799, Tutor, 1800-4; Phillips Prof. Theol. 1804-27; Prof. Moral Philos. and Civil Polity, 1827-38; now (1855) Emeritus Professor, and retired from professorial duties. Mrs. S. d. Mar. 3, 1826. Chil.,
- 157 1. Anna Pope, b. Mar. 8, 1812; m., May 18, 1836, Rev. Everts Worcester, grad. Dart. Coll. 1830, Tutor 1832-33, ordained in Littleton, N. H.,

* William Shurtleff, of the early Plymouth Colony Stock, b. Ap. 4, 1730; m. Nov. 1753, Hannah Cady, of Tolland, Conn., and settled in Ellington, then called East Windsor, Conn. In 1787, he moved to Chesterfield, N. H., where he d. in 1802, and his wid. d. July, 1803. They had nine children, the youngest of whom was Roswell. It is supposed that his wife Hannah (Cady) was a dr. of John Cady, "of Tolland," who m. in Wat., May 6, 1726, Hannah, dr. of John and Jemima Abbott, of Wat. [See Abbott, in Part II., and Cady, in Part II.]

- where he d. Oct. 21, 1836, aged 29. He was a son of Rev. Leonard Worcester, of Peacham, Vt., who m. a daughter of Rev. Samuel Hopkins, D.D., of Hadley. His wid. m. (2d), Oct. 3, 1844, Joseph Emerson, Jr., a merchant, of Hanover, b. in Norwich, Vt., Oct. 3, 1807. One child, Roswell Shurtleff, b. Feb. 20, 1846.
2. Roswell, b. Mar. 12, 1816, d. Nov. 6, 1820.
3. William Joseph, b. Aug. 24, 1819, d. Nov. 26, 1820.
- 158 4. Susan Augusta, b. Jan. 14, 1822; m., Ap. 13, 1847, Abner Hartwell Brown, b. July 6, 1816, son of Abner and Polly (Ager) Brown, of New Ipswich, grad. Dart. Coll. 1839, Tutor 1840-42; M. D. Yale, 1844; Prof. of Chemistry in Willoughby Univ., and in the Berkshire Med. School. He settled in Lowell, was M.M.S.S., and d. in Lowell, 1851. Chil.,
1. Abner Hartwell, b. Nov. 21, 1848, d. Sept. 23, 1849.
- 159 2. Susan Anna, b. Aug. 19, 1850.
5. Sarah Elizabeth, b. and d. July, 1825.
5. JOWATHAN, b. Dec. 19, 1756, d. Mar. 28, 1760. 6. BENJAMIN, b. and d. 1759.
- 160 7. ABIGAIL, b. Oct. 17, 1761; m. Dea. JONAS REED, Jr., of Rutland.
- 161 8. ELIZABETH, b. May 26, 1764, d. unm.
- 162 9. BENJAMIN, b. June 12, 1768, of Rox.; m. 1793, MARY HOVEY. Chil.,
163 1. *William H.*, b. Sept. 27, 1794. 2. *Maitilda*, b. July 23, 1796.
- 165 3. *Stephen*, b. Dec. 31, 1798. 4. *Sarah*, b. Feb. 14, 1801-2.
5. *Maria Paine*, b. Sept. 14, 1803.
6. *Josiah H.*, b. Oct. 20, 1806, settled in Grafton.
- 169 10. LUCRETIA, b. Dec. 11, 1771.
-
102. †162 (VI.) Capt. WILLIAM HAMMOND, of Newton; m. (1st), Ap. 18, 1770, MARY LIVERMORE, of Waltham. [Livermore. 130.] She d. 1775, aged 28, and he m. (2d), Nov. 12, 1778, RELIEF BALDWIN, dr. of Henry and Abigail (Butler) Baldwin, of Shrewsbury, from Pelham, N. H. [See Ward, p. 246.] He moved to Bangor, Me., in 1808, and d. about 1834, aged 94. Chil.,
- †163 1. ELIZABETH, b. Sept. 26, 1770; m., 1793, JOSHUA MAREAN.
- †164 2. WILLIAM, b. Jan. 27, 1772.
- †165 3. JOSHUA, b. Nov. 2, 1773; a Captain; m. ELIZABETH, dr. of Caleb Kendrick, of Newton. He was lately living in Northampton. Chil.,
†166 1. *Elisha Livermore*, b. Dec. 29, 1799; m., and lives in Northampton.
- †167 2. *Elizabeth*. 3. *Emily*. 4. *Mary L.* 5. *Sarah T.* 6. *Susan*. 7. *Harriet*.
- †168 8. *William*. 9. *Jane*. 10. *Albert*.
(By 2d wife, Relief.)
- †169 4. CHARLES, b. Sept. 6, 1779. 5. ELISHA, b. Ap. 14, 1781.
- 171 6. MARY, b. Oct. 11, 1782; m. Dr. ABBOT, of Bangor.
- 172 7. NANCY, b. May 29, 1784; m. — TAYLOR.
- 173 8. HARRIET, b. Mar. 3, 1786; m. — TAYLOR. 9. RELIEF, b. Nov. 27, 1787.
- 175 10. MELINDA. 11. SOPHIA.
-
125. 176 (VI.) SAMUEL HAMMOND, a merchant, of Boston, engaged in the East India trade; m. in Boston, June 4, 1794, SARAH DAWES, b. Ap. 23, 1768. He d. Nov. 4, 1838. Chil.,
- 177 1. JOHN LUCAS, b. Feb. 21, 1795; d. May 10, 1846, s. p.
- 178 2. CHARLES, b. May 18, 1796. Some time a member of Harv. Coll., a merchant, of Boston.
- 179 3. HANNAH DAWES, b. Nov. 4, 1797; m., Feb. 13, 1822, Hon. NATHANIEL POPE RUSSELL, of Boston, his 2d wife. Chil.,
- 180 1. *Samuel Hammond*, b. Jan. 3, 1823; m., Ap. 22, 1847, *Louisa Ann Adams*, of Boston. Chil.,
1. Edith, b. Nov. 8, 1848. 2. Alice, b. Mar. 13, 1852.
- 183 2. *Mary Ann Palfrey*, b. Jan. 5, 1826.
- 184 3. *Nathaniel Pope*, b. Feb. 1, 1829; grad. Harv. Coll., 1849.
- 185 4. MARY ANN, b. Jan. 15, 1800; m., Mar. 11, 1823, Hon. JOHN GORHAM PALFREY, b. in Boston, May 2, 1796; grad. Harv. Coll., 1815, D.D. 1834; LL.D., 1838; ordained in Boston, June 17, 1818; Prof. Sac. Lit., in Harv. Univ., 1830 to 1839, S.H.S., &c. Chil.,

- 186 1. *Sarah Hammond*. 2. *Anna Russell*. 3. *John Gorham*, d.
 189 4. *Francis Winthrop*, grad. Harv. Coll., 1851.
 190 5. *John Curver*, grad. H. C., 1853; a cadet at West Point.
 191 6. *Mary Gorham*.
 192 5. SAMUEL, b. Oct. 7, 1801; a merchant, of Boston: m., Nov. 5, 1828, SUSANNAH
 COPLEY GREENE, dr. of the late Gardner Greene, Esq., of Boston. He d. Sept.
 10, 1834, and his wid. d. Mar. 22, 1844, aged 38. Chil.,
 193 1. *Gardner Greene*, b. Nov. 20, 1832.
 194 2. *Samuel*, b. Jan., 1835 (posthumous).
 195 6. SARAH, b. Feb. 21, 1803; d. Oct. 20, 1820.
 196 7. CATHERINE, b. May 20, 1804; m., Sept. 19, 1833, JOHN GARDNER GIBSON, Esq.,
 merchant, of Boston. He d. May 12, 1838. Chil.,
 197 1. *John Gardner*, b. Aug. 21, 1835.
 198 2. *Charles Hammond*, b. Nov. 1, 1836.
 199 8. WILLIAM DAWES, b. Ap. 13, 1806; grad. Harv. Coll., 1827; d. Nov. 12, 1835, s. p.
 200 9. ALMIRA, b. Dec. 13, 1809; m., Sept. 3, 1838, WALTER COOPER GREENE, Esq.,
 merchant, of N. York city (son of Dr. Ezra Greene, of Dover, N. Y., a surgeon,
 U. S. Army). She d. July 20, 1847. Chil.,
 201 1. *Sarah Hammond*, b. July 16, 1840. 2. *Walter Hammond*.
 Moses Bigelow and Mary Hammond, of Newton, m., in Wat., June 15, 1756.

- p. 272. **HARRINGTON**.—[1.] Robert Harrington took the oath of fidelity, 1652. He
 was selectman 15 years, 1679–1700. He d. May 11, 1707, aged 91. [See Goldstone,
 in Part II.] His inventory embraced house and mill, £120.
 p. 273. [2.] For chil. of George and Susanna, read Robert and Susanna.
 [17.] John's 1st child, Elizabeth, was b. Feb. 20, 1705–6.
 p. 274. [26.] Daniel Harrington, was selectman 12 yrs., 1701–1729.
 [†31.] Robert Harrington had a 7th child, Thaddeus.
 [†39.] See Locke Family, p. 308.
 p. 275. [40.] For Ap. 4, read Ap. 5. Will of Thomas Harrington, dated Mar. 27, proved
 Ap. 5, 1712, mentions wife Rebecca, eldest son Ebenezer, youngest son George, son
 Thomas, and drs. Susanna and Rebecca.
 [46.] Capt. Samuel Harrington, selectman of Wat., 1713 to 28.
 [53.] For Grant [14.], read Grout. [See Grout, Part II.]
 [59.] Francis Harrington, m. (2d), in Westboro, Nov. 14, 1752, Deborah Brigham.
 [61.] For dr. of, &c., read granddr. of. See Morse, 53, Part II.
 p. 276. [97.] He and wife adm. f. c. Feb. 28, 1742–3. He was constable 1728, and select-
 man 1743, 50, 52.
 p. 277. [134.] In the margin, for 284, read 248.
 [141.] Thomas Harrington, m. (1st) in Camb., Feb. 5, 1711–12, Abigail Rice. He was
 constable 1728, and selectman 1735.
 p. 278. [†143.] For settled, read, was ordained Nov. 4, 1741. For Dec. 18, read Dec. 10.
 [See Worcester Mag. II., pp. 321–327.]
 [†144.] Mrs. Henrietta Locke d. Oct. 4, 1777. [See Locke Family, p. 53.]
 [†145.] She had an only and illeg. child, Emily, who m. — Carter, and had 1.
 Timothy Harrington Carter, of Boston. [See Clarke, 44–8.]
 [†149.] For Anna (? Mary), &c., read, Anna, b. July, 1758.
 [145.] Abigail Harrington (?) m., 1738, Benjamin Garfield. [? 66 and 104.]
 [147.] (?) John Harrington, of Waltham, m., in Westboro, Dec. 20, 1766, Mary Whitney.
 [149.] CALEB HARRINGTON, of Waltham, m. SARAH MILLER, May 3, 1774, in Westboro,
 where he settled. Chil.,
 1. *Ebenezer*, b. Oct. 13, 1776. 2. *Barnard*, b. Oct. 18, 1777.
 3. *Hannah*, b. July 27, 1779. 4. *Elizabeth*, b. Oct. 10, 1780.
 5. *Polly*, b. Mar. 4, 1781. 6. *Sarah*, b. Mar. 6, 1784.
 7. *Caleb*, b. Nov. 23, 1785. 8. *Nahum*, b. Mar. 7, 1788.
 p. 279. [165.] Capt. Edward Harrington was selectman of Wat., 1750, 53, 54, 56, 61, 62.
 His father Edward [52.], was selectman 1716, 30, 31.
 p. 280. [185.] Lieut. SAMUEL HARRINGTON, moved to Westboro. His first wife, SARAH, d.
 about 1733 or 34, and he m. (2d) ELIZABETH —, who was adm. f. c. in Westboro,
 Oct. 5, 1744. He d. Mar. 18, 1784, aged 80, and his wid. Elizabeth, d. Ap. 8, 1801
 [gravestone]. Chil.,
 1. *Samuel*, bap. in Waltham, May 19, 1728. 2. *Mary*, bap. in W., May 19, 1728.
 3. *Thankful*, b. in Westboro, June 24, 1730. 4. *Samuel*, b. May 15, 1732.

(By 2d wife.)

5. *Joseph*, b. Mar. 26, 1738; m. (pub. in Westboro, Mar. 17), 1764, *Ruth Merriam*; both adm. f. c. Nov. 1, 1767. He d. Oct. 13, 1815, and his wid. *Ruth*, d. Dec. 13, 1818. Chil.,
1. *Lucy*, b. Sept. 17, 1765.
 2. *Hannah*, b. Dec. 19, 1767.
 3. *Ruth*, b. Ap. 28, 1772.
 4. *Aaron*, b. Ap. 17, 1774.
 5. *Nahum*, b. June 13, 1778.
 6. *Joseph*, b. June 27, 1781.
 7. *Samuel*, b. Oct. 24, 1784.
 8. *Betsey*, b. May 15, 1787.
6. *Sarah*, b. Dec. 17, 1741.
7. *Marah* (*Mary*), b. July 2, 1744, adm. f. c. Dec. 22, 1771.
8. *Elizabeth*, b. Ap. 29, 1747, adm. f. c. Jan. 12, 1777.
9. *Eli*, b. Sept. 24, 1749, adm. f. c. Ap. 24, 1771.
10. *Lydia*, b. Ap. 22, 1754.
11. *Pernis*, b. Ap. 21, 1757.
12. *Benjamin*, b. Aug. 18, 1761; of Westboro; m. (pub. Jan. 3), 1789, *Anna Chamberlin*. Chil.,
1. *Dana*, b. Feb. 25, 1790.
 2. *Eli*, b. June 6, 1791.
 3. *Hollis*, b. Feb. 17, 1793.
 4. *Anna*, b. Oct. 11, 1795.
 5. *Edmund*, b. Sept. 5, 1797.
 6. *Susanna*, b. June 12, 1799.
 7. *Samuel Austin*, b. Mar. 16, 1801.
 8. *Hannah*, b. Jan. 8, 1803; d. May, 1845.
 9. *Curtis*, b. Mar. 21, 1805; d. Ap. 6, 1826.
 10. *Edward*, b. Oct. 10, 1807.
- [190.] "Master Harrington," who grad. Harv. Coll., 1728, was selectman of Wat., 1763, 64, and was teacher there as late as 1766.
- p. 283. [291.] *Richard Harrington*, of Lex., m., in Newton, Oct. 28, 1731, his cousin, *Abigail Hammond*. [See *Thomas Hammond*, 52, Part II.]
- [311.] *John Harrington* (probably a son of *Robert* [28.]), m., Dec. 3, 1761, *Mary Wooten*, dr. of Capt. *John Wooten*, an Englishman, a shipmaster, who made 22 voyages to Surinam. [See *Locke Fam.*, p. 68.] Chil.,
1. *Abigail*, b. Mar. 3, 1763, now (1853) living; m., 1781, *William Munroe, Jr.* 8 chil.
 2. *Sarah*, b. Feb. 17, 1766.
- p. 284. [316.] *Abraham Harrington*, grad. Harv. Coll., 1812; d. 1828, probably son of *Abraham* and *Anna* (*Russell*) *H.*, of Weston.

HARRIS.

- 1 (I.) *ROBERT HARRIS* and *ELIZABETH BOUGHEY* (*Boffee*), m. in Roxbury, June 21, 1642-3. They lived within the bounds of Brookline, where are some of the records of the family. Chil.,
- 2 1. *ELIZABETH*, b. Nov. 9, 1644.
 2. *TIMOTHY*, bap. July 9, 1650.
6. 4 3. *DANIEL*, b. May 14, 1652.
4. 4. *PRISCILLA*, b. Oct. 7, 1653.
-
4. 6 (II.) *DANIEL HARRIS*, of Rox. (*Brookline*), m., June 14, 1682, *JOANNA BROWN*. He was, by Boston, elected constable of Muddy River, Mar. 14, 1692-3. He d. Dec. 15, 1733.
- 7 1. *DANIEL*, b. Nov. 14, 1682; d. soon.
 2. *PRISCILLA*, b. Jan. 4, 1684-5.
 - 8 3. *THOMAS*, b. Sept. 22, 1686.
 4. *JOANNA*, b. May 28, 1690; m. *ABRAHAM WOODWARD* [2], in Part II.
24. 10 5. *NATHANIEL*, b. May 2, 1692, of Wat.; d. 1761.
- 11 6. *ELIZABETH*, b. Mar. 5, 1693-4; m., in Wat., Ap. 29, 1724, *JOSHUA WARREN, JR.* [*Warren*, 38.]
- 12 7. *TIMOTHY*, b. June 20, 1696; a blacksmith; m. *MARY* —, and resided some time in Wat., where he had
- 13 1. *Samuel*, bap. Sept. 26, 1725.
 2. *Mary*, bap. Aug. 25, 1727.
 - 15 3. *Anna*, b. Feb. 4, 1729-30.
 4. *Abijah*, b. Nov. 25, 1732.
- 17 8. *SARAH*, b. June 8, 1698 (?) m., Mar. 4, 1730-1, *JOHN HOPPEN*, of Rox.
- 18 9. *ROBERT*, b. Aug. 1, 1700; m., *LYDIA WOODWARD*, only dr. of *George, Jr.*, and *Lydia* (*Browne*) *Woodward* [11, and see 13, Part II.]
- 19 [Wat. cautioned against (settlement of) *Robert Harris*, from Scituate, Ap. 1734, living in a house of *Jonas Bond*.]
- 20 10. *MEHTABEL*, b. Oct. 14, 1702 (?); m., July 20, 1738, *STEPHEN WALKER*.
- 21 11. *DANIEL*, b. May 2, 1704.
- 22 [Daniel Harris, of Dudley, and Elizabeth Bridge, of Rox., m., June 20, 1745.]
- 23 12. *BENJAMIN*, b. Jan. 19, 1707.

10. 24 (III.) NATHANIEL HARRIS, by trade a clothier, settled first in Needham, where he belonged at the time of his marriage. Soon after this, he moved to Wat., was selectman 11 years, 1733 to 1746, Rep. of Wat. 1735, 36, 37, and a justice of the peace. He held a license as a retail trader 1740 to '49. He m., Jan. 30, 1717-18, HANNAH FULHAM, dr. of Col. Francis Fulham, Esq., of Weston [Fulham, 13]. He d. May 13, 1761, aged 69 [gravestone]. July 10, 1778 (after the decease of his late widow) an order was obtained to divide his estate—to be divided into 9 rights or shares, and eldest son, Thomas, to receive 2 shares.
-
- 25 1. THOMAS, eldest son, bap. in Wat., Oct. 10, 1725, was probably the Thomas Harris, "of Dorchester," who m. in Wat., Aug. 22, 1745; LUCY PEIRCE [25-4]. Ap. 13, 1773, his son Samuel, a clothier, of Fitchburg, conveys his right in the estate then improved by his grandmother, Hannah.
- 27 2. FRANCIS, b. in Wat., Oct. 3, 1721. He settled in that part of Groton which became the town of Shirley, and, in 1747, he was one of the petitioners for the incorporation of Shirley. He was a captain, a member of the County Convention of 1774, and of the first and second Provincial Congress in 1774 and '75. He m. SUSANNA —. Chil.,
 1. Sarah, b. Nov. 20, 1747, d. Oct. 4, 1756.
 2. Francis, b. May 20, 1752; d. Oct. 11, 1756.
- 28 3. Asa, b. Oct. 27, 1754; of Lunenburg, by wife Esther, had,
 1. Francis, b. Feb. 22, 1777. 2. Asa, b. Aug. 28, 1778.
- 31 4. Sarah, b. May 2, 1757. 5. Abigail, b. Aug. 9, 1759.
- 33 6. Hannah, b. Mar. 14, 1762. 7. Francis, b. June 21, 1764.
- 35 3. SARAH, b. Dec. 6, 1723; (?) m. WILLIAM WHITE, "Jr." [? White, 8-1.]
- 36 1. William, b. in Wat., Aug. 28, 1751.
- 36½ 2. Nathaniel, b. in Shirley, Dec. 21, 1752. [Caution against (the settlement of) William White, wife Sarah, and sons William and Nathaniel, from Wat., previous to Jan. 1755.]
4. PRISCILLA, b. Aug. 29, 1725; d. May 2, 1728.
- 37 5. NATHANIEL, m., June 2, 1748, ANNA MEAD, and settled in Groton, where he probably remained only a short time. In 1755, Nathaniel Harris, aged 28, enlisted in Shirley. He moved from Wat. to Medford in 1762, and he resided in Newton in 1765. Chil.,
 1. Fulham, b. in Groton, May 4, 1750. 2. Jane, b. in G., Jan. 1, 1752.
- 40 3. Nathaniel, bap. in Wat., June 25, 1758.
- 41 6. PRISCILLA, b. Feb. 4, 1728-9; m., Dec. 17, 1751, NATHANIEL SMITH, of Groton [? Smith, 118]. They settled first in Groton, where their dr. Susanna was born, Mar. 2, 1753. Afterwards they settled in Mason, N. H., where they resided in 1778.
- 42 7. BENJAMIN, b. Ap. 24, 1731; m., Feb. 20, 1755, MARY ODDLETON [? Addleton, Addington, Atherton.] Had he a 2d wife, Abigail? Benjamin Harris, and wife Abigail, had dr. Mary, b. in Wat., Mar. 19, 1761. [Caution, May 15, 1764, against (settlement of) Benjamin Harris, an infant, from Providence June last.]
- 49 8. HANNAH, b. Ap. 13, 1733; m., Feb. 20, 1755, JOSEPH HAY, q. s.
- 50 9. STEPHEN, b. June 23, 1735, of Wat., m., Jan. 16, 1755, SARAH BROWN, "both of Watertown." They both o. c. Mar. 2, 1755. Chil.,
 1. Nathaniel, b. Mar. 20, 1755. 2. Anna, b. Ap., d. May, 1757.
- 53 3. Hannah, b. June 28, 1760.
- 54 4. Stephen, b. May 24, 1762; m. Catherine —. Chil.,
 1. Samuel, bap. Mar. 11, 1787. 2. Hannah, bap. Aug. 1, 1788.
- 55 3. Stephen, b. Nov. 8, 1789. 4. Nathaniel, b. Jan. 12, 1791.
- 57 5. John, b. Ap. 17, 1793. 6. Mary, b. Sept. 8, 1797.
- 59 7. Elijah, b. Oct. 28, 1799. 8. Catherine, b. Oct. 9, 1801.
- 61 9. Joseph, b. June 26, 1804.
- 63 5. Sarah, bap. May 19, 1765. 6. Mary, bap. Jan. 4, 1767.
- 64 7. Lucy, bap. Ap. 2, 1769; m., May 23, 1797, William Berry.
- 66 [? John, son of Stephen Harris, bap. in Wat., Mar. 9, 1755.]
- 67 10. FULHAM, d. Nov. 6, 1738, aged 1 yr., 5 m., 20 d.

plantation, or bring a vote from **** that he be free from fear [Mass. Col Records]. Mar. 3, 1656, Isaac Hart, of Reading, and wife Elizabeth, sold to Samuel Stratton, of Wat., land, "with an old house," and other parcels of land. Ap. 29, 1672, Goodm. Stratton, aged 80, testified that Isaac Hart's house was in Watertown Field, near Cambridge.

HASSELL.—(? Hazell). The Will (? nuncupative) of John Hazell (of "Secunke," alias Rehoboth) dated Nov. 19, 1651, mentions kindred, but no wife nor children; appoints John Clarke, of R. I., and Nathaniel Briscoe, of Wat., exrs. Wit. by John Warren and Thomas Arnold, both of Watertown. Inventory, by Edward Smith and Joseph Torrey, Oct. 11, 1651, £165 19s. Dr. John Clarke, and Mr. Briscoe, being about to sail to England, gave a letter of att'y to Thomas Broughton, of Boston, son-in-law of Mr. Briscoe, for the settlement of Hazell's estate. The witnesses to this letter of attorney were Richard Croade and Nathaniel Briscoe, Jr. [See p. 742.]

p. 285. **HASTINGS.**—[6.] Nathaniel Hastings m. Mary, eldest child of John and Elizabeth Nevinson [See Nevinson, in Part II]. She d. Oct. 14, 1732, aged 64.

[7.] For 212. 7 in the margin, read, 226. 7.

[11.] For 11, in the margin, read 29. 11.

[14½] Between Wm. and Samuel, insert, 5½, Samuel, bap. in Charlestown (or by the minister of Charlestown), Sept. 8, 1695.

[15.] For 15, in the margin, read 36. 15.

[17.] **THOMAS HASTINGS**, a cordwainer, m. **SARAH**, supposed to be a daughter of Andrew White [White, 6], and settled in Lex., where six of his chil. were born. Thence he removed to Littleton, where he d., and admin. was granted to his wid. Sarah, William White [8], of Waltham, surety. His Inventory was dated July 14, 1747. An order by the Court, for the appraisal of his estate, was dated Aug. 29, 1748, and in the settlement of the estate, the following document was brought into court. The corrections and additions to it are in brackets. "The record of the births of the children born unto Thomas Hastings, late of Littleton, deceased. Sarah, his wife.

1. *Hepzibah*, b. Jan. 11, 1708 [1718], m. *Thomas Powers*.

2. *Elizabeth*, b. Mar. 31, 1709 [1720].

[3. *Thaddeus*, b. Feb. 21, 1721-2; d. next Sept 20, not mentioned in the document.]

4. *Kezia*, b. July 7, 1723; m. *Benjamin Blanchard*.

5. *Josiah*, b. July 26, 1724.

[6. *Thomas*, b. Nov. 17, 1725; not mentioned in said document, probably d. young.]

7. *Submit*, b. Oct. 15, 1729. 8. *Sarah*, b. Dec. 3, 1731.

9. *Esther*, b. June 7, 1733. 10. *Abigail*, b. Ap. 5, 1736.

11. *Andrew*, b. July 15, 1738. 12. *Ruhamah*, b. Dec. 5, 1740."

p. 286. [18.] Admin. granted to wid. Martha, Jan. 13, 1695-6. Inventory, Oct. 22, 1695, House and land, £55; one-third dwelling-house that was his father's, £10; 10 acres of dividend land, £5.

[19.] For 19, in the margin, read 45. 19.

[23.] Samuel Hastings had three wives. He m. (2d), Elizabeth, dr. of John and Elizabeth Nevinson [see Nevinson, in Part II.] She was the mother of his three children, Elizabeth, Samuel, and Benjamin. Mar. 1695, he was licensed by the Court to keep a tavern in Wat., in a house which had been occupied by his father-in-law, Nevinson.

[24½.] For Nov. 29, read Nov. 28.

[28.] This, and not [33], is probably the Nathaniel, who m. Esther Perry. See [33, p. 286].

[29.] [The family of this John Hastings, as printed, is erroneous, being confounded with another family, viz., [226]. The following substitute is presented; and it may be observed, that there are some conjectures for further inquiries to confirm or confute.]

11. 29 (III.) **JOHN HASTINGS**, of Wat., m. (1st), Nov. 2, 1702, **SUSANNA BEMIS** [Bemis, 19]. She d. Nov. 15, 1703. He m. (2d), Jan. 8, 1706-7, **SARAH FISKE** [N. Fiske, 22]. It is probable that he moved to Lunenburg, or that vicinity, about 1723. Chil.,

30 1. **SARAH**, b. Nov. 8, 1707. 2. **SUSANNA**, b. Ap. 4, 1710.

32 3. **JOHN**, b. Feb. 4, 1711-12.

- 33 4. NATHANIEL, b. June 9, 1714; m. in Lunenburg, May 21, 1741, LOIS HOUGHTON. Chil.,
- 34 1. John, b. Oct. 20, 1741. 2. Lois, b. May 17, 1743.
- 36 3. Nathaniel, b. May 28, 1745. 4. Caleb, b. Mar. 31, 1749.
- 38 5. David, b. Mar. 31, 1751. 6. Elizabeth, b. Ap. 14, 1753.
- 40 7. Nicholas, b. June 30, 1755.
8. Jonathan, b. Aug. 16, 1756, by wife Nancy, had, in Lun., son Christopher, b. Feb. 26, 1793.
- 42 9. Susanna, b. Mar. 11, 1759. 10. Samuel, b. May 19, 1761.
- 44 11. Esther, b. July 21, 1765; m., July 8, 1788, Phineas Divol.
- 45 12. Eunice, b. June 6, 1769; m., Mar. 18, 1790, Asael Divol.
- 46 5. HANNAH, b. Jan. 24, 1716-17; m., Aug. 15, 1735, DANIEL FARNSWORTH, "both of Lunenburg."
- 47 6. EUNICE, b. Sept. 3, 1722; m., Dec. 22, 1741, STEPHEN FARNSWORTH, "both of Lunenburg."
- 48 7. MARY, b. in Lun., July 6, 1731; m., July 20, 1748, NICHOLAS DIKE, both of Lunenburg.
- 49 [ABIGAIL HASTINGS, of Lun. (? dr. of John and Sarah), m., in Lun., July 29, 1741, JONATHAN HAMMOND, of Lower Ashuelot [Swansey], N. H.
-
- [36.] (III.) SAMUEL HASTINGS, a tailor, of Wat., and of Waltham, m. BETHIA —. He was a selectman of Waltham 1742, 43, 44. Chil.,
- 51 1. SAMUEL, b. Mar. 30, 1721, of Lex.; m. LYDIA TIDD, b. July 6, 1732, dr. of Daniel and Hepzibah (Reed) Tidd, of Lex. She d. Nov. 10, 1802, aged 71. Chil.,
- 52 1. Isaac, b. Dec. 26, 1755, of Lex.; m. Sarah, dr. of Phinehas and Mary (Wellington) Stearns [see I. Stearns, 219, V.]. 9 chil. He d. July 2, 1831, and she d. May, 1834. Chil.,
- 53 1. Sophia, b. Oct. 17, 1781; d. Nov. 1841; m. Isaac Saltmarsh Spring. 3 chil.
- 54 2. Isaac, b. Nov. 3, 1783, lost at sea, unm.
- 55 3. Thomas, b. Feb. 12, 1786; m. in Vt.; d. in Montreal, July, 1835.
- 56 4. Abigail, b. May 20, 1788; m. Jonathan Cary, of Boston, s. p.
- 57 5. John, b. July 12, 1790; m. wid. — Riggs, s. p.
- 58 6. Phinehas Stearns, b. Oct. 13, 1792; m., 1835, wid. Elizabeth Bowles, s. p.
- 59 7. Leonard, b. Sept. 6, 1794; d. Nov. 10, 1802.
- 60 8. Samuel, b. Sept. 24, 1798; m., Aug. 27, 1827, Lucy R. Reed, of Lex.
9. Maria, b. Mar. 1, 1801; m. Wm. H. Cary, of New York, son of John Cary, s. p.
79. 61 2. Samuel, b. July 11, 1757; a major, of Lincoln.
- 62 3. Lydia, b. Nov. 29, 1759; d. July 22, 1788, unm.
- 63 4. Bethia, b. Mar. 23, 1761, d. Aug. 3, 1765.
5. Hepzibah, b. July 3, 1762; m. (1st), in Lex., Ap. 17, 1781, John Sawin [25], "of Waltham." 2 chil. She m. (2d) Jonas Wyeth, of Cambridge. She d. May 17, 1789.
- 64 6. John, b. July 13, 1764; m., 1784, Esther Lawrence [? Lawrence 483, Part II]. He d. June 25, 1789, aged 25, and she d. Oct. 24, 1794, aged 30. Chil.,
1. Ann. 2. Elizabeth.
- 66 7. Bethia, b. June 25, 1766; d. July 28, 1786, aged 20.
- 67 8. Abigail, b. Ap. 20, 1768; d. May 10, 1788, aged 20.
9. Thomas, b. Ap. 25, 1772; d. Sept. 8, 1775.
- 68 2. THADDEUS, b. Oct. 15, 1723; m. in Wat., Mar. 29, 1763, MARY STRATTON. Chil. ?
- 69 1. Samuel, a painter, of Boston.
- 70 2. Thaddeus, b. in Lex., Sept. 10, 1769, of Chelsea, a mariner.
- 71 3. Abijah, and 4. Jacob, both shipmasters, of Boston.
- 73 3. MARY, b. Dec. 16, 1725.
- 74 4. ABIGAIL, b. Mar. 8, 1727-8; m., Ap. 2, 1747, SAMUEL BROOKS, of Medford, an uncle of Gov. John Brooks. [Brooks 110, p. 724.]
- 75 5. ABIAH, b. May 9, 1730. 6. PHILEMON, b. Ap. 6, 1732.
- 77 7. ANNA, b. Mar. 8, 1733-4. 8. MARTHA, b. Mar. 23, 1736.
-
61. 79 (V.) Major SAMUEL HASTINGS, of Lincoln, m. LYDIA NELSON, b. Ap. 6,

- 1758, dr. of Thomas and Lydia Nelson, of Lincoln. He d. Jan. 8, 1837, aged 76, and she d. Ap. 5, 1829, aged 71.
- 80 1. LYDIA, b. Feb. 20, 1780; m., Feb. 22, 1807, Capt. NEHEMIAH INGRAHAM, of Boston. She d. June 23, 1823, aged 43, s. p.
- 81 2. SAMUEL, b. Dec. 15, 1781; d. Sept., 1798.
- 81 3. JONATHAN, b. Aug. 17, 1783; m. NANCY ADAMS, of Lincoln, and settled in Brighton. 10 children.
- 82 4. DORCAS, b. June 22, 1785; m., Oct. 8, 1810, Rev. DAVID MARRITT, of Standish, Me.
- 83 5. THOMAS, b. May 22, 1787; of E. Cambridge; m. (1st) MARY ROBBINS, dr. of Moses and Amelia (Carey) Robbins, of Brighton. She d. July 12, 1818, aged 26. He m. (2d), May 29, 1823, MARTHA LIVERMORE, dr. of Jonathan and Martha (Robbins) Livermore, of Brighton. [Livermore, 108-5.] Chil.,
- 84 1. *Anna Marritt.* 2. *Mary Robbins.*
(By 2d wife.)
- 86 3. *Martha Robbins*, b. Aug. 31, 1824; m., Nov. 29, 1852, *Henry Whitney*, of Cambridge.
- 87 4. *Thomas Nelson*, b. Dec. 9, 1825; m., 1851, *Emeline Coffin*, of Brighton.
- 88 5. *Mary Frances*, b. Dec. 20, 1827; d. Aug. 30, 1829.
- 88 6. *Mary Frances*, b. July 23, 1830.
- 89 7. *Francina Augusta*, b. May 23, 1832.
- 90 8. *Leander Norton*, b. Aug. 2, 1834.
- 91 9. *Alphonso Winthrop*, b. Mar. 1, 1836.
- 92 6. POLLY, b. Ap. 10, 1789; m., May 20, 1811, Capt. BENJAMIN OLIVER WELLINGTON, of Lexington. [Wellington, †106.] 11 chil.
- 93 7. OLIVER, b. May 16, 1791; m. (1st) ELIZA BEMIS, of Lincoln. [Bemis, 150.] 6 chil. He m. (2d) wid. HULDAH TRABRO. 2 chil.
- 94 8. HEPSTY, b. May 24, 1793; m., May 26, 1813, PETER WELLINGTON, of Lex. [Wellington, †116.] 13 children.
- 95 9. HARRIET, b. July 12, 1795; m. ELIAS SMITH, of Lex. 6 children.
- 96 10. JAMES, b. Oct. 5, 1797; m. SALLY MEAD, of Lex. 9 children.
11. SAMUEL, b. Jan. 23, 1800; d. Oct., 1802.

- p. 287. [46.] Elizabeth, m., Ap. 8, 1735, Samuel Whitney. [243.]
[49.] Strike out [34]. The parentage of this Hannah Hastings, not ascertained.
- p. 289. [100.] William Hastings, "of Watertown," belonged to Capt. Jonathan Brown's Co., at Lake George, in 1758.
- p. 291. [162.] For the parentage of Jane Sheldon, see Hinman, p. 170.
[178.] Rev. Thomas S. Hastings, m., July 1, 1852, Fanny De Groot, dr. of Henry and Mary (Nesbitt) De Groot, formerly of N. York; was ordained by the 4th Presbytery of N. York, July 10, and installed in Presbyterian Church of Mendham, N. J., Oct. 27, 1852. Chil.,
1. Frank Seymour, b. May 31, 1853.
- p. 293. [212.] Strike out 7, from the margin. Also, strike out, probably a son of Nathaniel [6]. Mrs. Mercy (Ward) Hastings, d. aged 102 years. Perhaps it will be discovered that this John Hastings was a descendant of John Seaborn Hastings, of Cambridge.
- [216-1.] Ruth, m., Mar. 19, 1800, Ezra Newton.
- [216-2.] Esther, m., June 13, 1802, Joseph Leonard, of Roxbury.
- [216-3.] Sally, m., June 4, 1806, Jabez Fox, of Berkeley, R. I.
- [226.] In the margin, read ¶. 226, and strike out the whole parenthesis. This JOHN HASTINGS, was a son of Nathaniel and Mary (Nevinson) Hastings [6]. In 1738, he exchanged estates (8 acres near the old burial-ground, bought of Richard Beers, and others, Feb. 27, 1718-19) with Samuel Stratton, and after that date resided in the lower or eastern part of Watertown, opposite to the N.E. corner of Mount Auburn Cemetery. He d. about 1746. In 1754, a strip of territory, about half a mile wide, was taken from the East side of Watertown, and annexed to Cambridge, thereby bringing this homestead within the bounds of the latter. Chil.,
1. *Moses*, mentioned in the Will of wid. Elizabeth (Nevinson) Bond, as her grandson [? great grandson]; m., in Shrewsbury, Ap. 25, 1739, *Abigail Taylor*, b. Mar. 5, 1720, dr. of Serj. William and Elizabeth (Haggood) Taylor, of Shrewsbury. About 1745, he sold his farm in Shrewsbury, to Col. Nahum Ward. He d. June 10, 1767, aged

52, and his wid. m., May 7, 1770, *Samuel Bigelow*. He is said to have gone from Brookfield, to S., where his chil. were born.

1. Rebecca, b. Dec. 20, 1739. 2. Catherine, b. Jan. 10, 1741.

3. Bulah, b. Jan. 17, 1747. 4. Neverson [Nevinson], b. Ap. 19, 1749. [Ward, p. 303.]

2. *Mary*, b. Jan. 24, 1716–17.

3. *Anna*, b. Dec. 22, 1718; m. *Jacob Caldwell*, q. v. 6 chil.

4. *Zebulon*, b. Oct. 2, 1720; had a son d. Dec. 26, 1748.

5. *Seth*, b. Aug. 22, 1722; m. *Hannah Soden*, dr. of Thomas Soden, of Camb., and sister of Samuel, of Wat.; inherited his father's homestead. His wid. Hannah, m., in 1779, Capt. *Wm. How*. She d. Aug. 28, 1817, aged 90.

(EPITAPH.)

"Here lies interred the remains of Mr.

SETH HASTINGS, a noted and
respectable gentleman;

whose Benevolence extended to all.

Who departed this life Oct. 15, 1775,

in the 54th year of his age.

Blessed are the Dead, who die in the Lord; they

Rest from their labor, and their works follow them."

Chil.,

1. *Mary*, b. Sept. 28, 1750. 2. *Thomas*, b. Nov. 18, 1753; d. in Camb., 1823.
[*Thomas*, who m. *Elizabeth Morse*, was a son of *Samuel*, of Newton.]

3. *John*, b. Sept. 13, 1759.

4. *Seth*, b. Ap. 5, 1762; grad. Harv. Coll., 1782, d. 1831; settled in Mendon, Mass., was member of Congress, and was father of *William Soden Hastings*, grad. Harv. Coll., 1817, also member of Congress, d. 1842.

5. *William Soden*, b. Nov. 6, 1764; d. Jan. 24, 1792, unm.

6. *Robert*, d. Oct. 5, 1775, set. 9.

6. *Enoch*, b. Aug. 31, 1724; d. soon. 7. *Elisha*, b. Jan. 10, 1726–7.

8. *Asher*, b. Nov. 9, 1728; d. 1731. 9. *Sarah*, b. Feb. 4, 1730–1; d. 1731.

10. *Elizabeth*, b. Oct. 27, 1732. 11. *Sarah*, bap. Sept. 21, 1735.

[236.] For the parentage and family of Major *Samuel Hastings*, see 61 and 79, p. 790.

MARRIAGES IN WESTON.

Joshua Bigelow and *Lydia Hastings* [? dr. of *Joseph*, 220], m., June 22, 1725.

Elias Hastings and *Lucretia Whitney*, m., Feb. 9, 1786

John Hastings, of Southboro, and *Rebecca Bartlett*, of W., m., Oct. 4, 1795.

James Smith and *Esther Hastings*, m., Jan. 7, 1796.

John Perkins, of Westport, and *Betsey Hastings*, m., Jan. 11, 1801.

Jonas Hastings and *Betsey Warren*, m., July 29, 1806.

Jonathan Warren, Jr., and *Polly Hastings*, m., Oct. 8, 1811.

Abijah Coburn and *Lydia Hastings*, m., Ap. 2, 1812.

Joseph Butterfield and *Polly Hastings*, pub. Feb. 5, 1792.

Francis Hastings and *Nabby Pierce*, m., 1816.

Francis Hastings and *Sarah Pierce*, m., 1817.

MARRIAGES IN WALTHAM.

Mr. Josiah Hastings and *Mrs. Sarah Stearns*, m., Jan. 16, 1769.

Benjamin Hastings, of Berlin, and *Abigail Hagar*, m., Dec. 17, 1805.

Edward Lawrence and *Lucretia Hastings*, m., Sept. 5, 1807.

Nathan Sanderson and *Mrs. Sarah Hastings*, m., Oct. 22, 1807.

Thomas Hastings and *Elizabeth Morse*, both of Newton, m., Mar. 20, 1777.

MARRIAGES IN WATERTOWN.

John Hastings, of Waltham, and *Hannah Draper*, m., Dec. 25, 1783.

Hepzibah Hastings and *John Steward*, m., in Wat., Dec. 11, 1735.

p. 294. **JOHN HASTINGS**, of Cambridge.

In fifth line, for *Lucius K. Paige*, read *Lucius R.*

[5.] Strike out (?).

[15.] *Abigail Hastings* did marry *Moses Boardman*.

18.] Strike out, Perhaps this was the estate of Samuel, Jr.

[20.] Strike out all after 1668, and read, m. Hannah, dr. of John Marrett. He d. Sept. 28, 1699. His wid. Hannah o. c. Feb. 4, 1699–1700, and same day was bap. her son Samuel, who d. next Aug. 15. [See [6] and [23], p. 789.]

[21.] Stephen Hastings m. Hannah Stacey. He d. 1736–7; son Samuel administrator.

[21–1.] This Samuel Hastings, a tanner, was of Watertown, 1736–7; m., about that time. Hepzibah, dr. of Thomas Dana, of Camb, and settled in Newton. 10 chil., two of whom Joseph Stacey, and Aaron, grad., Harv. Coll. 1762 and 1780. [See Jackson, p. 305.]

[21–2.] Thomas Hastings, cordwainer, of Camb.; (?) m. a dr. of Thomas Soden, of Camb. Chil. numerous. He d. 1787, aged 70.

[26.] Mrs. Lydia (Champney) Hastings d. in 1691, aged 48.

- p. 295. **HAWKINS.**—July 8, 1700, Daniel Smith, and wife Ruhamah, sold to Samuel Stearns, and his wife Mary, all their right in the estate of T. Hawkins. Same date, Samuel Stearns, and wife Mary, sold to Daniel Smith 20 acres in Camb., near land of John Smith; 6 A. of meadow in Camb.; 2 A. plowland in Wat., near Samuel Hagar and Charles River; also, one-fourth corn-mill on Beaver Brook.

HAY.—Mar. 8, 1774, caution of Reading against (settlement of) James Hay, wife Elizabeth, and chil. Abigail, James, Thomas, Sarah, Anna, Lucy (? Lilly), John, and Lucretia, from Watertown.

HAYWARD.—For Haywood, read Hayward. The homestall of John Hayward, in Wat., of 24 acres, was contiguous to Fresh Pond, on the South side. He retained it several years after he moved to Dedham. In 1644, besides this homestall, he owned five other lots in Wat., amounting to 70 acres. He was adm. freeman May 14, 1634, then aged 43, and was, by the Gen. Court, appointed constable of Dedham, Dec. 4, 1638. He probably had a first wife, whose name has not been discovered in the records. The wife Mary, mentioned in his will, was probably the wid. of Henry Aldridge, of Dedham, adm. freeman 1645, d. Feb. 23, 1646. The Will of wid. Mary Hayward, of Dedham, dated Sept. 5, 1683, proved May 29, 1684, mentions her eldest son, Thomas Aldridge, and his dr. Mary; son Samuel Aldridge [Henry A. had son Samuel, b. Mar. 10, 1644]; dr. Sarah Woodcock [wife of John], and granddr. Sarah (Woodcock) Westbrook; dr. Esther Kingsbury [wife of Eleazer]. To her dr. Sarah she gave 6 acres of meadow, by meadow of Robert Ware, bought of Cornelius Fisher, of Wrentham, butting upon planting field in the island of Dedham. [See Suff. Prob. VI., p. 256; also, p. 295, and George Phillips [1], in Part II.]

- p. 296. **HEALY.**—Nathaniel Healy (son of William and Grace, first of Rox., and afterwards of Camb., where Nathaniel was bap., Feb. 6, 1658), moved to Newton after the birth of his second child, and by wife Rebecca had nine other chil., viz., Nathaniel, Mary, Samuel, Ebenezer, Martha, Lydia, John, Joshua and Hannah. [See Jackson, p. 307.] He was killed by Indians at Groton, July 21, 1706. [See Butler, p. 96; also, see Ives; also, Camb. Church Gathering. p. 58.]

HEADLEY.—Benjamin Headley, with wife Mehitabel, after the birth of their 2d child, moved to Groton, where she d. Ap. 13, 1749, aged 57. Chil. b. in Groton,

3. Benjamin, b. July 25, 1715. 4. Mehitabel, b. Feb. 14, 1716–17.

5. John, b. Sept. 28, 1719 (? of Weston). 6. Phebe, b. Sept. 25, 1721.

7. Simon, b. Mar. 20, 1723. 8. Hannah, b. Feb. 10, 1725.

9. Eleazer, b. Nov. 8, 1727. 10. Ann, b. Ap. 9, 1730 [Butler, p. 405.]

This name in the Groton Records is written Hadley. According to those records their dr. Sarah d. Aug. 3, 1731.

HEARD.—Caution against (settlement of) Peter Heard, physician, who came from Camb. to Wat., Ap. 1725. He returned to Cambridge 1731–2. Suit, Peter Hurd, of Wat., since of Camb., vs. Joseph Holding, of Watertown. [See Eddy, 7–3.]

HENDERSON.—Capt. John Henderson, with wife Mary, moved from Groton to Wat., in Ap., 1734, and at first occupied the house of John Smith. He d. before 1754.

HEWES.—[See Goldstone, p. 774.] Ap. 5, 1686, John Stearns, of Wat., and wife Judith, sold to John Hues, of Camb., 25 A. in Camb. (Lex.).

p. 297. **HILL.**—Caution against (settlement of) Jacob Hill (a tanner), with wife and 2 chil. from Camb., Nov. 1736. Caution against the same from the same, with wife and 3 chil., Aug. 26, 1740.

HINDS.—Mar. 1748, caution against (settlement of) Ambrose Hinds and family, from Wat. to Cambridge.

HOAR.—[See Dean's Hist. of Scituate, p. 285.]

[2.] For Edward, read Edmund.

p. 298. [17.] See History of New Ipswich, p. 391.

[19.] Isaac Hoar settled in Sudbury.

[31.] Wife Esther d. in childbed, Feb. 5, 1739, aged 25.

[37.] For Mary, read Mercy. She m., Feb. 10, 1772, Samuel Farrar, Jr. [Note, p. 723.]

p. 299. [34.] Nathaniel Peirce Hoar, bap. in Wat., Sept. 5, 1784.

[67.] For Farran, read Farrar. [See Farrar Family, p. 38.]

p. 300. **HOBBS.**—[4-6.] Mary Derby was dr. of Gen. Samuel Barton Derby, formerly of Salem.

[5-3.] Samuel Hobbs m., Mar. 27, 1834, Abigail Woodward, dr. of Rev. Dr. S. Kendall. [Woodward, 214.]

[5-7.] Elmira Hobbs m., 1825, Amos Upham [Upham, 8-a].

[8.] For [App. I., 21-8] read, [App. I. 90]

[13.] For [99] read [177].

[21.] See Locke Family, p. 307.

HOBURN.—Caution, Dec. 13, 1748, against (settlement of) Patrick Hoburn, wife Ann, and brother John, who came into Wat. in the summer.

p. 301. **HOFFINGS.**—Caution against (settlement of) John Conred Hoffings, wife Catherine, and 4 chil., John, Elizabeth, Catherine, and Mary, who came into Wat. Mar. 1749.

HOLDEN.—[2.] Justinian, b. 1644. [3.] John, b. 1657.

[11.] Mary, 2d wife of J. H., b. 1647. Justinian Holden, a witness in Court, June 9, 1679, then aged 66, therefore b. in 1613.

[12.] Samuel Holden m. Susanna Shattuck [47]. Ap. 27, 1707, Samuel and Isaac Holden, of Camb., and John Holden, of Wat., sold three-fourths acre in Camb. to Dr. Palgrave Wellington. About 1699, there was a Samuel Holden of Charlestown.

[13.] Mar. 11, 1708-9, John Holden, and John Traine, Jr., for £85, bought land in Nonesuch [Meadow in Weston], of Simeon Stoddard, of Boston; land formerly of James Sherman, [55], of Salem, physician, taken on execution. Mar. 25, 1709, John Holden, of Wat., sold to Solomon Prentice, of Camb., land in Cambridge.

[14.] Isaac Holden, of Camb., where he d. May 8, 1772, by wife Joanna, had dr. Joanna, d. Feb. 28, 1728, aged 20, and dr. Tabitha, b. and d. 1710. There was an Isaac Holden, cordwainer, of Wat., 1736-7.

p. 302. [17.] Joseph Holden, in 1732, constable of Wat.; m., Feb. 17, 1713-14, Abigail Shattuck [44].

[18.] Elizabeth Holden m. Philip Goodin, of Cambridge.

[20.] Strike out this line. See [17].

HOLLAND.—In 4th line, after 1709, insert, with Samuel Barnard. Mar. 10, 1709-10, It was ordered that the estate of Nathaniel Holland be disposed of between John Holland, Sarah Phillips, and John Ormes. Dec. 12, 1710, caution against (the settlement of) Sarah Holland, a child, from Barnstable. Dec. 1716, James Holland was sick at Mr. Gibbs's. Dec. 27, 1735, the selectmen ordered James Holland to be buried at the town's cost.

HOLMES.—First line, read John Holmes, son of Robert Holmes, of Camb, m., Sept. 13, 1664, Hannah Thatcher [2], and moved to Salem. His son John d. in Wat., June 9, 1691.

HOMANS.—Capt. Thomas Homans's wife d. in Wat., Aug. 8, 1740, and he, with Mary Gunnison, was pub. at Kittery, Sept. 13, 1740. He was constable of Wat. 1744-5.

HOMER.—In 1694, Michael Homer, aged 26 or 27, wife Mary, and child, were of Watertown.

HOOPER.—Feb. 16, 1701-2, Mr. Foxcroft appointed guardian of Hannah, aged about 18 yrs., and Henry, aged about 16 yrs., chil. of Richard Hooper, physician.

HOUGHTON.—Ralph and John Houghton, very early settlers of Lancaster, are said to have first settled in Watertown; but their names are not found in the town records.

HOW.—1st line, for 1632, read 1634. Elder Edward How d. June 24, 1644. In 11th line, after Boxstead, insert, Co. Essex. July 18, 1658, "Miss — Bunker," from Watertown Church, was adm. to Charlestown Church. George Bunker, who married the wid. of Edward How, of Wat., was adm. freeman Mar. 4, 1634-5, and was constable of Charlestown in 1638. He was one of the wealthiest settlers of the town, and in the divisions of land, his shares were commonly the largest of any. One of his lots of land on Bunker Hill ran over its summit, and hence its name. [Frothingham's Hist. of Charlestown, p. 83.]

Elder Edward How, of Watertown, and Matthew Cradock, of London, were joint and equal proprietors of the first mill built in Watertown. It is probable that the mill had been built by How, at the joint cost of himself and Mr. Cradock. It appears by the earliest list of possessions, and likewise by his Inventory, that Mr. How owned the land (2 acres) between the river and "Mill Creek," extending from the Mill up to the stone dam. His homestead of 40 acres was also in that vicinity. Aug. 19, 1635, he sold his moiety of the mill to Thomas Mayhew for £200, with bond for £400, and mortgage, with condition, "that if said Mayhew pays to How £200, bond to be void, else said How shall enter upon the moiety of said mill, as if he had never made sale thereof." Mayhew bought the other moiety of the mill of Nicholas Davison, agent of Matthew Cradock, of London. Ap. 18, 1640, Mayhew sold the mill to Dep. Gov. Dudley for £400. It is probable that Mayhew failed to perform his conditions with How, and that this gave rise to the case briefly noticed by Winthrop, vol. II., p. 50. In his Inventory, by (Rev.) John Knowles (Capt.) Wm. Jennison, and (Capt.) John Sherman, is included this bond and mortgage of Thomas Mayhew, for £400.

HUBBARD.—See Ives, p. 306, and Hamlet, in Camb. Church Gathering, p. 60. It appears that James Hubbard, by wife Sarah, had, 1. James, who m. a dr. of Miles Ives, and was his exr. and residuary legatee. 2. Sarah, m. Samuel Champney. 3. Thomas, b. in Wat., Aug. 10, 1638, "joined the Church in Wethersfield." He d. in 1738, and his wid. Sarah m. William Hamlet, of Cambridge, and of Wat. [See p. 269.]

[The following account of a Hubbard family is here inserted, on account of its many affinities with other families included in this volume. It is very defective, and it is hoped that some one will be induced to supply its deficiencies.]

GEORGE HUBBARD, and wife **MARY**, are supposed to have come from England about 1635 or 6, and went with the early settlers to Wethersfield, of which he was delegate in 1638. His lot of land in the Naubuc Farms, laid out in 1640, on the east side of the river (now in Glastenbury), contained 195 acres. He soon afterwards moved to Milford, and was there admitted to the church, Jan. 15, 1644. In 1648, he moved to Guilford, and was there admitted to the church, Oct. 6, 1650. He was living in Guilford in 1665. He had at least nine children, some of whom were born in England, but the order of their birth has not been ascertained. [See Chapin's Hist. of Glastenbury, p. 171.] Chil.,

- †2 1. JOHN, first of Wethersfield, afterwards of Hadley.
 †3 2. GEORGE, of Greenwich.
 †4 3. DANIEL, bap. at Milford, 1644, of Guilford.
 †5 4. WILLIAM, (?) of Greenwich.
 †6 5. MARY, m. about 1648, JOHN FOWLER, of Guilford.
 †7 6. SARAH, m. — HARRISON.
 †8 7. ABIGAIL, bap. in Milford; m. HUMPHREY SPINNING, of N. Jersey.
 †9 8. HANNAH, bap. 1644; m. — MAYLESS.
 †10 9. ELIZABETH, late in life, m JOHN NORTON.

†2. 1 (II.) JOHN HUBBARD, supposed to be the eldest son of George and Mary, after his father's removal to Guilford, returned and settled in Wethersfield, where he had 4 chil. born. On the 18th April, 1659, he was one of the signers of the engagement, "to remove themselves and their families out of the jurisdiction of Connecticut, into the jurisdiction of Massachusetts," and who went and planted Hadley. He removed thence to Hatfield, some time before his decease, and d. there in 1705 or 6. His wife's name does not appear in the records, but he was a brother-in-law of Dea. Robert Merriam, of Concord. Chil.,

- 1‡ 1. MARIA, b. in Wethersfield, Jan. 1650.
 2. JOHN, b. in W., Ap. 12, 1655, of Glastenbury.
 2‡ 3. HANNAH, b. in W., Dec. 5, 1656.
 8. 3 4. JONATHAN, b. in W., Jan. 3, 1658-9; of Concord, Mass.
 4 5. DANIEL, b. in Hadley, 1661; of Hadley. 12 chil.
 6. MERCY, b. in H., 1664.
 6 7. ISAAC, b. in H., 1666; of Hatfield many years; a Deacon; 6 sons and 2 drs. He moved to Sunderland in 1714.
 7 8. SARAH, b. in H., 1679. [One of the drs. m. — COLE, another m. — WARNER.]

3. 8 (III.) JONATHAN HUBBARD, son of John, of Hadley, went to Concord as early as 1680, before the decease of his uncle, Robert Merriam, and settled on the farm bequeathed to him by this uncle. He m. HANNAH, dr. of Samuel and Elizabeth (King) Rice, of Marlboro, and gr. dr. of Edmund and Thamezin Rice, of Sudbury. [See Brown [6], p. 119; also, Barry, p. 373.] He d. July 17, 1728, aged 70, and his wid. Hannah d. Ap. 9, 1749, aged 89 [gravestones.] Chil. Neither the dates nor the order of their births given. [See Shattuck, p. 376.] In 1684, he seems to have been proprietor of the Hubbard lot, in Glastenbury, which afterwards belonged to his brother John [Hist. Glast., p. 172]. Chil.,

20. 9 1. JONATHAN, b. 1682.
 10 2. SAMUEL, b. about 1687, of Concord; m. (1st), — CLARKE, and m. (2d), — TEMPLE. He d. Dec. 12, 1753, aged 66; had son Isaac.
 11 3. JOSEPH, "3d child," a captain, of Concord; m., in 1713, REBECCA, dr. of Capt. Joseph Bulkley. He d. Ap. 10, 1768, aged 80, and his wid. d. 1772, aged 76. Chil., 1. Rebecca. 2. Elizabeth. 3. Lucy. 4. Abigail. 5 and 6. Thomas and Lucy (twins).
 12 4. ELIZABETH, m. — HEYWOOD, of Concord.
 13 5. JOHN, m. (1st), — BLOOD. He m. (2d), AZUBAH MORE, of Sudbury. He settled first in Worcester, and about 1728 moved to Rutland, and erected a mill on Millbrook. He was a captain, an active, enterprising, useful man, in ecclesiastical, civil, and military affairs. By his first wife he had several daughters, and by his 2d wife he had several daughters and two sons, who both d. young, and he also lost five daughters about the same time. His dr. Hannah m., May 3, 1733, Lieut. Paul More, of Rutland, whose dr. Esther m. Stephen Church, and was the mother of Rev. John Hubbard Church, D.D., of Pelham, N. H. Capt. Hubbard, in advanced age, sold his estate in Rutland, and went to spend his last days with his dr. Abigail, who m. Charles Heywood, of Holden. He had five other married daughters. [See History of Rutland, p. 107.]
 14 6. DANIEL, m. — DAKIN, and settled in Holden.

- 15 7. THOMAS, m. — FLETCHER.
 16 8. ABIGAIL, m. (1st), FLETCHER, and m. (2d), BRADSTREET.
 17 9. EBENEZER, inherited the homestead; m. MARY CONANT. One account says he
 m. — BILLINGS. He d. May 21, 1755, æt. 54,
 18 10. MARY, m. — DAVIS. 11. HANNAH, m. — TEMPLE.
-
9. 20 Major JONATHAN HUBBARD, Jr., and REBECCA BROWN, both of Concord,
 m. in Wat., Sept. 26, 1704, by Jonas Bond, Esq. He resided some time in Groton,
 where at least four of his chil. were born, and thence moved to Townsend, where
 his wife d. Nov. 2, 1751, and he d. there Ap. 7, 1761, aged 76 [gravestones]. Chil.,
-
- 21 1. REBECCA, m. in Groton, Sept. 22, 1722, Col. JOSEPH BLANCHARD, of Dunstable.
 22 2. HANNAH, m., in Groton, Nov. 23, 1732, Col. JOSIAH WILLARD, then of Lunenburg.
 23 3. RUTH, b. 1716; m. (1st), in Lunenburg, Ap. 7, 1736, Rev. DAVID STEARNS [see
 p. 466]. She m. (2d) Nov. 9, 1768, Rev. AARON WHITNEY, of Petersham. She
 d. in Keene, Nov. 1, 1788, aged 72.
 31. 24 4. JONATHAN, b. about 1719, of Charlestown, N. H.
 25 5. ABIGAIL, b. in Groton, June 25, 1721; m. in Lunenburg, Dec. 25, 1738, OLIVER
 FARWELL, of Dunstable.
 26 6. JOHN, b. in G., May 24, 1723; d. Feb. 17, 1724.
 27 7. MARY, b. in G., Ap. 12, 1725; m. (1st), in Lunenburg, July 21, 1740, JOHN
 JENNISON [33.] He d. 1751, and she m. (2d), Ap. 21, 1758, Col. BENJAMIN
 BELLOWA. [See pp. 532 and 807.]
 28 8. JOHN, b. in G., Ap. 3, 1727; of Townsend, Mass., afterwards of Walpole, N. H.,
 where he was an apothecary. He m. in Lunenburg, Mar. 20, 1748-9, HANNAH
 JOHNSON [see ¶6, p. 540]. Only 2 chil., so far as ascertained, viz.,
 29 1. Rebecca, m., about 1770, Col. John Bellows, of Walpole. [See Bellows, 76,
 p. 536.]
 30 2. John, b. in Townsend, Aug. 8, 1759, posthumous; grad. Dart. Coll. 1785;
 studied Theology, but did not enter upon ministerial duties, on account of
 the weakness of his voice. He was preceptor of New Ipswich Acad.
 1789-95; Judge of Probate for Cheshire Co., N. H. 1798-1802, elected
 Prof. of Nat. Phil. Dart. Coll. in 1804, d. June, 1810. He m., Aug. 10, 1791,
 Rebecca Preston, b. July 16, 1768, dr. of Dr. John, Jr., and Rebecca (Farrar)
 Preston, of New Ipswich. [See Hist. of N. Ipswich, p. 210.] Chil.,
 1. John. 2. Josiah. 3. Samuel. 4. Harriet. The two elder sons entered
 the Freshman Class of Dart. Coll. in 1809, and left college at the end of
 the year, soon after the decease of their father.
-
24. 31 JONATHAN HUBBARD, Jr., m., in Lunenburg, Sept. 24, 1739, ABIGAIL JEN-
 NISON. [35.] About 1757, he moved to Charlestown, N. H., where he and his
 wife both died. He d. Mar. 29, —.
-
- 32 1. GRACE, b. in Lunenburg, Aug. 22, 1740; m. RICHARD GLIDDEN, of North
 Charlestown, N. H., where they lived and died, and have descendants at this
 time.
 33 2. ABIGAIL, b. in L., Sept. 17, 1742; m. (1st) — GILES, and m. (2d) —
 STEPHENS, of Goshen, N. H., and d. s. p.
 34 3. REBECCA, b. in L., Sept. 27, 1744.
 35 4. DAVID, m. — LARAREE, of Charlestown; settled in the north part of Charles-
 town; numerous descendants, some of them still in their native town.
 36 5. SAMUEL, d. young, s. p.
 37 6. JONATHAN; after the d. of his father, he returned to Massachusetts, and there
 spent his youth. At the arrival of manhood, he returned to Charlestown, N. H.,
 where he settled permanently. In early life, he was a merchant's clerk, after-
 wards devoted to agriculture, and was Town Clerk. He possessed great
 equanimity, was strictly temperate, and d. in 1828, æt. 80. He m. EUNICE, dr. of
 Moses Wheeler, of Charlestown, a woman of great worth and most exemplary
 piety. She d. in 1815, æt. 60.
 38 1. Fanny, b. Dec. 19, 1777; m. Gideon Kidder, of Wethersfield, Vt., b. 1782;
 d. 1853. Chil.,

- 39 1. Maria, b. Nov., 1803; d. 1814.
 2. Theron Hubbard, b. Feb. 12, 1805; a trader, of Racine, Wis.; m. (1st), July 28, 1830, Hannah Hill, of Wallingford, Vt., b. Aug. 1, 1811; d. Oct. 4, 1852, by whom he had 1. George Theron, b. July 13, 1831; d. Ap. 8, 1853. 2. Frances Maria, b. Dec. 31, 1832; d. Mar. 2, 1851.
- 40 3. Mary Lois, b. Feb. 4, 1836. He m. (2d), July 26, 1853, Eliza Jane Shawke, of New Lisbon, O., b. Ap. 25, 1826.
 3. Frederick Lewis, b. Dec. 6, 1806; a physician, of Newton Falls, O.; m. (1st), Mar. 26, 1835, Pamela Haskell, of Wethersfield, Vt., b. Sept. 23, 1805; d. Sept. 15, 1842. He m. (2d), Mar. 9, 1843, Mrs. Laura Catherine Stauley, b. Oct. 7, 1815. He d. July 26, 1847. Chil.,
 1. Charles Louis, b. May 14, 1836.
 2. Edwin Haskell, b. Mar. 26, d. Sept. 16, 1837.
 3. Walter Edson, b. Dec. 2, 1838.
 4. Pamela Grace, b. Jan. 14, 1842.
 5. Emily Irene, b. Oct. 27, 1845; d. Mar. 9, 1846.
- 41 • 4. Charles Jennison, b. June 11, 1808; d. July 11, 1810.
 5. William Jennison, b. Ap. 19, 1810; a Meth. Epis. minister.
- 42 6. Frances Sophia, b. May 22, 1814; m. Edwin R. Hine, of Newton Falls, O., b. Dec. 15, 1815.
- 43 7. Charles W. Burr, b. Nov. 13, 1815; a physician, of Troy, N. Y., m. twice.
- 44 2. Samuel, b. Aug. 6, 1781; a farmer, of Charlestown, N. H.; m. wid. Mary (Wells) Allen, of E. Windsor, Conn., b. 1781. Chil.,
- 45 1. George, b. Ap. 4, 1813; now (1854) of California; m. Martha Ann, b. 1821, dr. of Enos Stevens, Esq., of Charlestown, N. H.; dr. Ann Elizabeth, b. 1842.
- 46 2. Mary, b. May 25, 1815; m., Oct. 30, 1844, Dr. Benjamin C. Parker, of Acworth, N. H., b. 1785, s. p.
- 47 3. Huldah, b. June 28, 1817; of Charlestown, N. H.
- 48 3. Abigail, b. Dec. 1, 1786; m. Godfrey Cooke, a farmer, of Claremont, N. H., b. July 23, 1780; d. 1849. She d. Nov. 7, 1833, much lamented. Chil.
- 49 1. Catherine Matilda, b. July 25, 1806; m., Sept. 13, 1830, Charles R. Bingham, b. Mar. 1, 1806, a merchant, of Boston, of the firm of Clarke & Bingham, residing in Chelsea. Chil. 1. Harriet E., b. Mar. 8, 1832; d. 1833. 2. Helen C., b. Oct. 12, 1834. 3. Charles Godfrey, b. May 5, 1841; d. 1844. 4. Catherine E., b. July 23, 1845. 5. Mary, b. Aug. 5, 1847.
- 50 2. Henry Hubbard, b. Dec. 4, 1808; d. Jan. 28, 1838, having nearly completed his theological studies in N. Y. city.
- 51 3. George Wheeler, b. June 13, 1814; d. July 29, 1815.
- 52 4. Helen Maria, b. Sept. 13, 1816; m., Mar. 16, 1841, Frederick Smith, a farmer, of Claremont, N. H., b. Ap. 6, 1814. Chil., 1. Henry Cooke, b. Mar. 13, 1842; d. 1849. 2. Elizabeth Augusta, b. Nov. 21, 1846. 3. Arthur Frederick, b. Aug. 22, 1850.
- 53 5. George Francis, b. July 16, 1820; a farmer, of Claremont, N. H.; d. Oct. 22, 1847, much beloved and lamented.
- 54 6. Mary E. Bartow, b. June 11, 1827; m., Mar. 24, 1850, Edward A. Partridge, a civil engineer, b. Mar. 26, 1826. 1. Mary Elizabeth, b. Jan. 1, 1851.
- 55 4. Sophia, b. 1791; m. Edward Reid, b. at Ayr, Scotland, in 1777. He d. in 1844, in Charleston, S. C., where he had gone on business. Chil.,
 1. William Hubbard, b. in Dalton, N. H., in 1814; d. Ap. 29, 1834.
- 56 2. Sophia Eunice, b. in D., 1815; m., Oct. 19, 1834, William T. Vernon, of N. Y. city. One child, George Reed, b. July 28, 1838. She m. (2d), Rev. L. P. Crawford, a Presbyterian minister of Chicago, Ill.
- 57 3. Roswell Hunt, b. in Charlestown, N. H., Ap. 19, 1819, drowned at Rowley, Mass., July 3, 1837; engaged in preparing for the ministry.
- 58 4. Edward Loggie, b. in C., Nov. 24, 1820; d. in California, Aug. 1844.
- 59 5. Horace Hall, b. in C., Sept. 25, 1822, an Episcopal minister, of Water-town, Conn.; m., Sept. 1, 1851, Mary L. Brown, of West Bloomfield, N. Y. Son, Wm. Herbert, b. Sept. 22, 1852.
6. Lewis Hubbard, b. Mar. 2, 1825; a Presbyterian minister, of Fayette-

- ville, N. Y.; m., Sept. 17, 1851, Maria L. Fuller, of Kent, Conn. Son, Lewis F., b. Nov. 16, 1853.
- 60 7. Jane Elizabeth. b. in Warwick, R. I., Ap. 18, 1829, d. May 11, 1831.
8. Catherine Cook, b. in Providence, R. I., Nov. 6, 1830; m., July 2, 1851, Rev. Lewis P. Ledoux, of Opelousas, La., a Presbyterian minister, of Monroe, Mich. 1. Albert Reed, b. in Newport, Ky., Nov. 2, 1852.
- 61 5. *Jennison J.*, b. in 1794, a very industrious and prosperous farmer, of Charlestown, N. H.; m., Oct. 26, 1818, *Eliza Fitch*, of C., b. in 1800. Chil.,
- 62 1. Henry Fitch, b. in 1821; in furniture business, Stockton, Cal., unm.
- 63 2. Sarah Delano, b. 1823; m. Amasa Rice, a prosperous farmer, of Pittsfield, Mass. 1. Robert A., b. 1850.
- 64 3. Ghoran Fitch, b. Ap. 16, 1829, left home in 1846, for St. Louis, but not since heard of.
- 65 4. Robert Morris, b. in 1831, clerk in the banking-house of Clark & Barksdale, St. Louis.
- 66 6. *Lewis*; b. in 1796; when young went to one of the S. W. States, engaged in trade, was reduced by treacherous partners, and it is not known what became of him.

HUDSON.—Daniel Hudson was taxed in Wat. in 1652, and two acres were granted to him in King's Common, Oct. 22, 1653, he to make brick for the town's use. Nov. 7, 1664, he was released from the condition. In the Inventory of John Chinery was a lot of 10 acres, formerly of Daniel Hudson. He moved to Lancaster in 1664, where he, and his wife, and two daughters, were slain by Indians in 1695. [Worcester Mag. II., p. 296.]

- p. 304. **HUNT.**—John Hunt m. Ruth Fessenden, b. June 21, or 28, 1717, eldest child of William and Martha (Wyeth) Fessenden. He was selectman 1747, 52, 54, 55. [See Locke Fam., p. 315.]
- [1.] Mary, m. 1781, Dr. Richard Perkins, of Bridgewater, b. 1730, grad. Harv. Coll. 1748, his 2d wife. [See Hist. of Bridgewater, p. 267.] His first wife was a sister of Gov. John Hancock, and he was a brother of Ann, wife of Rev. Matthew Bridge [41], of Fram.
- [7-1.] Mary Hunt m. Dr. Eliakim Morse, of Wat., his 2d wife. [See Memorial of Morses, p. 45.] Wm. Hunt, Esq., had 5. Thomas.
- [8.] Katherine, d. unm. [11.] Sarah, d. unm.
12. Ephraim, m. — Palmer.

HUTCHINSON.—Cambridge, caution against (settlement of) Richard Hutchinson and family, from Wat., Ap. 1742.

HYDE.—For a copious record, and much exact and interesting information respecting the families and descendants of Dea. Samuel and Jonathan Hyde, of Newton, see Jackson's Hist. of Newton, pp. 313-326.

- p. 305. [32.] Philip Pratt, of Fram., m., in Weston, June 2, 1726, Mary Osland, of Newton.

- p. 306. **INGRAM.**—For page 14, read [See page 14.]

IVES.—[See Hubbard, p. 795; also, in Camb. Church Gathering, see Wm. Hamlet, p. 60, and Wm. Heily, p. 58.]

JACKSON.—About 1637, or earlier, Robert Lockwood, Isaac Sternes, and Henry Jackson, were lessees of the fishing weirs in Wat., for six years. This was probably the Henry Jackson who, then aged 29, embarked at London, in April, 1635, in the Elizabeth and Ann. For a copious and satisfactory account of the family and descendants of Dea. John Jackson, and Mr. Edward Jackson, of Newton, see Jackson's History.

JACOBS.—Nicholas Jacobs sold his homestall in Wat. to Robert Daniel before 1636, also, sold a lot near the river to John Barnard, and moved to Hingham. He was

licensed by the Gen. Court, Oct. 7, 1640, to keep an ordinary in Hingham. In Nov. 1646, he was appointed one of the Commissioners to end small causes, and was elected Deputy of Hingham in 1648, 49, &c. His Will, dated May 18, proved July 28, 1657, mentions wife Mary (Ex'x), eldest son John, son Joseph, drs. Mary Otis, Elizabeth Thackster, Sarah Cushen, Hannah (m., Dec. 13, 1657, Thomas Loring, Jr., of Hull), and Deborah. Inventory, £393 8s. 6d. [See Geneal. Reg. viii. p. 280.]

JAMES.—The marriage contract between wid. Reana James and William Andrew, was made Aug. 11, 1640, and on Aug. 21, 1664, "Daniel Kempster, aged 77," testified that he witnessed the signature of the contract.

JENNISON.—In 4th line from the bottom, for Black, read Block Island. Mr. William Jennison was by the court, chosen Ancient (ensign) to Capt. Patrick, Aug. 16, 1631, and held the office until Mar. 9, 1636–7, when he was chosen Captain for Watertown. He was one of the first three Commissioners for Watertown, appointed in 1638, to end small causes, and he appears to have held it, by reappointments, until his return to England. Oct. 6, 1634, he was fined £20, by the Court "for upbraiding the court with injustice, uttering these words: 'I pray God deliver me from this court,' professing he had waited from court to court, and could not have justice done him." At the next court, Ap. 7, 1635, this fine was remitted. The Colonial Records show that the court had great confidence in his capacity and integrity. He received numerous appointments on committees, of which he was often chairman, for determining boundaries between towns, and plotting new towns; also on questions of taxation, Indian affairs, and contested land claims. He, and Mr. Mayhew, both of Watertown, were appointed to bring Mr. Nathaniel Eaton (the first principal of Harvard College), to trial for his misconduct, chiefly in relation of his mal-treatment of Nathaniel Briscoe, Jr., son of Nathaniel, Sen., of Watertown.

In May, 1637, he was one of the four commissioners appointed by the court, to provide men, munitions, and provisions for the Pequod war. Sept. 3, 1638, the court granted him 200 acres of land, which was the land mentioned in the following transaction. Ap. 8, 1657, William Jennison, "of Colchester, Old England," by his brother Robert, his att'y, conveyed to Edmund Rice, 200 acres, granted to said William; bounded W. by the Dunster Farm; N. by Sudbury line; E. by Wat. line; S. by Dedham bounds. This land passed from Edmund Rice, to his son Matthew. This conveyance shows that Capt. Jennison was living in England, as late as 1657, and renders it probable that the Jennison family originated in Colchester, Co. of Essex.

According to Frothingham's Hist. of Charlestown, there was a William Jennison, residing there in 1678. This is probably a mistake for Jamieson, or Jameson.

p. 307. [2.] For 1688, read 1683; and for 1689, read 1687.

[3.] Strike out, Dea.

[6.] Ensign Samuel Jennison was Town Clerk, in 1691. His Will, dated Nov. 30, 1700, mentions eldest son Samuel; 2d son, William, of Sudbury; son Peter; youngest son Robert; eldest dr., Judith Barnard; 2d dr., Rachel Barron; dr. Grace Holden; youngest dr., Lydia; grandchil., Mary Jennison, James and Samuel Barnard, Timothy Barron, and John Holden; also Joseph Bowman. Inventory, dated Oct. 31, 1701. House, &c., £95; farm, 50 acres, £90; farm, 20 acres, £60; 12 acres in lieu of township, £5; 1 acre of meadow, £10. Ap. 5, 1699, James Barnard, of Sud., sold to Samuel Jennison, Sen., of Wat., gent., land in Sudbury. This was probably the land $\frac{1}{2}$ of which he (S. J.) gave to his son William, Sept., 1700.

[8.] For 1697–8, read 1698–9.

[11.] For 1741, read 1744.

[15.] Robert Jennison, m. Dorothy (Thomas) Whittemore, wid. of Thomas Whittemore, Jr., of Wat. [†4.]

[15–3.] Elias Jennison, of Sutton, d. previous to Mar. 4, 1760, when his estate was appraised by Isaac Barnard, Esq., Lemuel Chase, and Amos Dunell.

[23.] Josiah Jennison, m. Mary, dr. of Joseph and Dorothy Tidd, of Lex.

p. 308. [25.] (?) Nathaniel Jennison, m., in Rox., Aug. 4, 1774, Mehitabel Shirley.

[36.] Dr. Stanton Prentice, m. (2d), in Groton, Jan. 5, 1758, Rebecca Stephens. He d. Dec. 1, 1769, aged 58.

[37.] Mrs. EUNICE (Jennison) RICHARDSON, d. in childbed, Ap. 13, 1748, aged 26. Chil., 1. Lucy, b. July 21, 1740; d. Dec. 27, 1741.

2. Nathaniel, b. Mar. 20, 1742; a merchant, and tanner, of Salem; m., in Middleton,

Mass., Sept., 1771, *Eunice Putnam*, b. Mar. 29, 1751, dr. of David and Rebecca Perley Putnam, of Danvers. He d. of a casualty Jan., 1796, and his wid. d. Nov. 28, 1846, aged 95 yrs. 7 mos. and 27 d. Chil.,

1. Nathaniel. 2. Joshua. 3. Jesse. 4. Eunice. 5. Israel.

6. William Putnam, b. May 5, 1785; a shipmaster, afterwards a merchant, of Salem; m., Aug. 6, 1807, Deborah Lang, b. Sept. 23, 1785, dr. of Edward and Rachel Ward Lang. He d. Sept. 5, 1826, and his wid. Deborah, d. Mar. 4, 1845. Chil.,

1. Ellen Octavia. 2. Sarah Lang. 3. Augusta Ilsley.

4. William Putnam, grad. Harv. Coll., 1834; M.D., 1837, M.M.S.S.

5. Edward Symmes Lang, b. Feb. 28, 1816; m., in Salem, Oct. 6, 1848, Harriet Emeline Norris, b. Dec. 7, 1821, dr. of Emery and Abigail Millet Jeffs Norris, of Salem, and settled in Kendall, Kendall Co., Ill.

6. Eliza Jane. 7. Charles Frederick. 8. Caroline Louisa.

9. Nathaniel Putnam.

7. Betsey.

3. *Lucy*. 4. *Joshua*. 5. *Israel*, b. Mar. 29; d. Ap. 20, 1748.

[38.] For 1767, read 1757.

[40.] For Daniel Baldwin, read David Baldwin. [Baldwin, 11.]

[44.] *

[56.] Phinehas Jennison, moved to Newton about 1795, where he d. 1825, aged 82, and his wife d. in 1815, aged 72. Was it his son Phinehas [56-1.], who m. Sarah Whitney?

[56-2.] Susan Jennison, m. William, son of Smith and Lucy (Warren) Adams.

[56-3.] Chil. of Elias Jennison: 1. Susan. 2. Elias. 3. Joseph. 4. Joshua. 5. William. 6. Elijah. 7. Horace. 8. Henry. 9. Otis. 10. Sally. 11. Eliza. 12. Mary.

[56-4.] Benjamin Jennison, m., in 1804, Sukey Tallman. She d. in 1842, aged 60. Chil., 1. Joel, m., in 1831, Lucy W. Trowbridge, and settled in Bangor. 2. George. 3. Albert. 4. Edwin. 5. Martha. 6. Mary.

[56-6.] Josiah, of Newton, m., in Weston, Mar. 14, 1808, Hannah Howard (? Holden), Chil., 1. Josiah. 2. John. 3. Lucia. 4. Hannah. 5. Sarah.

[56-7.] William Jennison, d. unm.

p. 309. [62.] (IV.) Rev. WILLIAM JENNISON [see Jennison, 21, p. 307], b. in Wat., Feb. 9, 1706-7, grad. Harv. Coll., 1724; was ordained May 2, 1728, minister of the East Church, in Salem; was dismissed therefrom Sept. 13, 1736, for reasons not ascertained. He soon after returned to Watertown. Afterwards he preached as a temporary supply in Westboro, Holden, and other places; also taught school in Worcester, but did not again take a pastoral charge. He was a teacher in Watertown at the time of his decease, where he d. Ap. 1, 1750, aged 43. He m., May 15, 1730, ABIGAIL LINDALL, b. June 16, 1713, 4th dr. of Dea. James Lindall, Esq., of Salem, by his 2d wife, wid. Mary Weld, eldest child of John Higginson, Esq., by his wife, Sarah (b. June 25, 1653), eldest child of Thomas Savage. This John Higginson was a member of the Council of the Province, and Col. of the regiment; was the eldest child of Rev. John Higginson, minister of the First Church of Salem, and a grandson of Rev. Francis Higginson, who arrived in Salem, with his son John, June 30, 1629 [See General Reg. vii., p. 18]. His wid. Abigail, d. about 1764. In the latter part of her life, she resided in Danvers, where her daughter Mary was settled.

* The following marriages are found in the Boston Town Records. The parentage of these Jennisons has not been ascertained; probably they are the descendants of Peter, of Sudbury.

Peter Jennison and Jerusha Smith, m. in Boston, Jan. 3, 1759. Nathaniel Jennison and Sarah Dowse, m., in B., May 5, 1778. Benjamin James and Eunice Jennison, m., in B., June 11, 1778. John Wesley and Joanna Jennison, m., in B., Ap. 15, 1784. Abraham Frost and Phebe Jennison, m., in B., Mar. 20, 1788. John Simonds and Mary Jennison, m., in B., June 19, 1788. Thomas Doyle and Jerusha Jennison, m., in B., Sept. 18, 1790. John Thomas and Lucy Jennison, m., in B., Dec. 15, 1793. Samuel Jennison and Betsey Hathorn, m., in B., June 22, 1794. John Lucas Jennison and Betsey Jennison, m., in B., Feb. 5, 1795. John Jennison and Betsey Binney, m., in B., Jan. 17, 1796. Belcher Jones and Mary Jennison, m., in B., Aug. 26, 1798. Robert Wood and Susanna Jennison, m., in B., Mar. 10, 1799. Robert Carter and Catherine Jennison, m., in B., Mar. 20, 1800. Israel Whitney and Phebe Jennison, m., in B., July 17, 1803. John Jennison and Lydia Upham, m., in B., Dec. 13, 1808. Bezaele Bennett and Emma Jennison, m., in B., June 4, 1806. Asa Jennison and Caroline Dean, m., in B., June 7, 1807. John Haynes and Lydia Jennison, m., in B., Sept. 30, 1810. Rev. David Pickering, of St. Johnsbury, Vt., and Sally B. Jennison, m., in B., Jan. 9, 1816. David Norstrand and Eliza Jennison, m., in B., June 24, 1820. John Jennison and Matilda Huntress, m., in B., Mar. 1, 1832. George Jennison and Sarah T. Farmer, m., in B., Feb. 1, 1835. Maverick Jennison, of Auburn, and Hannah Newton, of Boston, m., Ap. 19, 1838.

1. ABIGAIL, b. Feb. 10, 1730-1; d. before 1736.
5. 2 2. WILLIAM, b. Mar. 19, 1731-2.
- 3 3. SAMUEL, b. 1733. He received a Lieutenant's commission in the public service, Feb. 13, 1756, and was probably a clothier, of Danvers, in 1755. About 1765, he was a merchant, of New London, Conn., and made several voyages to the W. Indies. At Oxford, Mass., he m. NAOMI EVERDEN, and was a member of the Provincial Congress from that town, in 1774. He d. in Oxford, 1790, s. p. His wid. m. JOHN WOLCOTT, Esq., and d. 1848, aged over 100 years.
4. TIMOTHY. 5. JAMES, both d. in Salem, before 1736.
49. 4 6. MARY, m., Nov. 4, 1753, THOMAS GILES, of Danvers.
-
2. 5 (V.) Dr. WILLIAM JENNISON studied medicine with Dr. Stanton Prentice, of Lancaster, who had married his aunt, Mercy Jennison [see 36, p. 308, and see Prentice Fam., p. 167]. He commenced the practice of medicine in Mendon, May, 1753, and afterwards engaged in trade. From Mendon, he moved successively to Douglas, Sudbury, and Brookfield. He was a man of great activity and energy, was a prominent whig in the revolutionary war, and was a member of the Provincial Congress from Mendon. He m. in Mendon, Ap. 25, 1754, MARY STAPLES. He d. of a casualty (thrown from his horse) in Brookfield, May 8, 1798, aged 66, and his wid. d. in Camb., May 3, 1822, aged 90. [See Sibley's History of Union, pp. 47-49.]
- 6 1. MARY, b. Oct. 13, 1755; m., Dec. 25, 1776, JONATHAN WHIPPLE, of Uxbridge. She d. Sept. 1812, aged 57. Chil.,
- 7 1. Henry, a colonel and a bookseller, of Salem.
- 8 2. Charles, a bookseller, of Newburyport, father of Samuel K. Whipple, a bookseller, of Boston.
- X 9 3. William Jennison, grad. Harv. Coll. 1804, was a lawyer, of Dudley, and afterwards of Cambridge. He m., May 21, 1841, Mrs. Charlotte M. (Holden) Lander, formerly of Salem, then of Cambridge. He d. Nov. 4, 1850, aged 63.
- 10 4. Mary Jennison m. Joseph Manton, of Providence.
- 11 2. WILLIAM, b. Aug. 4, 1757, grad. Harv. Coll. 1774, immediately afterwards commenced the study of law with Caleb Strong, and pursued it until the breaking out of the revolutionary war. He, with his brother Samuel, then enlisted in the public service. [It is said that their father, being a very decided whig, would not allow his sons to draw any pay during the whole war.] He served during the whole war; was at one time paymaster of the army; at another, a Lieut. of Marines, and was U. S. Pensioner for his services. He m., Mar. 3, 1784, MARY VIBERT (? Wibird), of Boston. After this, he resided in Pennsylvania, and farther south, devoted to teaching. His later years were spent in literary pursuits. He d. in Boston, Dec. 24, 1843, and his wid. Mary d. in Boston, Ap. 11, 1853, aged 90. Chil.,
- 12 1. Charles, a shipmaster, of Boston; m., Dec. 26, 1816, Ruth Beale, of Boston. He d., leaving 2 ds. 1 d. unm.
- 13 2. Mary E., m., Oct. 17, 1843, Calvin Slade, then of Boston, now (1854), a merchant, of San Francisco, Cal.
- 14 2. William, b. Aug. 4, 1795; some time a merchant in Baton Rouge, La., where he m., in 1824, Maria Antoinette Fowler, of that place. He removed thence about 1837, and engaged in the iron trade, of the firm of Mackay, Oakley, and Jennison, in New York, but residing in Brooklyn. He now, 1854, resides in Danville, Penn. Chil.,
- 15 1. Mary Elizabeth, m. in 1844, Edward H. Baldy, Esq., a lawyer, of Danville, Penn.
- 16 2. William, b. 1826; LL.B. Harv. Univ. 1851, now (1854) a lawyer, of Detroit.
- 17 3. Henry Waller, unm.
- 18 4. Charles Ewer, a merchant, of Lower Saginaw, Mich.; m., 1853, Flora, dr. of Hon. James G. Birney, Esq., the distinguished advocate of free men, free soil, and a free press.
- 19 5. Joseph Fowler, b. Aug. 13, 1830, in Baton Rouge; grad. New Jersey Coll. 1852; now (1854) member of Princeton Theol. Seminary.

- 20 6. Melinda Anna, b. 1832, d. 1836. 7. Maria Antoinette.
 21 8. Benjamin Spencer, d. 9. Miriam Wycoff.
 10. Edward Oakley, d. early.
 22 11. John Morgan, b. 1840. 12. Albert, b. 1847, d. early.
 23 3. *Isaac W.*, some time a merchant in Mississippi; d. in Boston, Ap. 10, 1847,
 aged 44, unm.
 24 4. *Benjamin*, a merchant, in the South, where he m. He and wife d. of
 cholera in the same year, leaving a dr.
 25 Frances, who m. — Hooker, a lawyer, of Jackson, Miss.
 26 5. *Sarah Gummer*, m., Dec. 9, 1838, *Thomas Dunn*, of Boston; were soon
 divorced. Her only son, Benjamin Jennison, d. of a casualty in Boston,
 Jan. 5, 1854, aged 13 yrs.
 27 3. SAMUEL, b. May 26, 1759, grad. Harv. Coll. 1774. After serving in the Revo-
 lutionary army two or three years, as ensign, lieutenant, and quartermaster, he
 studied law, and was admitted to the bar of Worcester Co. He m., Dec. 25,
 1781, *SALLY*, dr. of Rev. Nathan Fiske, D.D., of Brookfield [N. Fiske, 45]. He
 d. in Thomaston Me., Sept. 1, 1826. Chil.,
 28 1. *Nathan Fiske*, b. 1783, unm.
 29 2. *Sally*, b. Aug. 25, 1785, unm.
 30 3. *Samuel*, b. Feb. 24, 1788, of Worcester; m. Oct. 15, 1816, *Mary Gould*
Ellery, dr. of Edmund Trowbridge Ellery, of Newport, R. I. Chil.
 31 1. Samuel, b. Jan. 31, 1821; grad. Harv. Coll. 1839; m. *Mary Lincoln*,
 dr. of Levi Thaxter, of Wat. Mr. Jennison has also several drs., of
 whom he declines to give any information.
 32 4. *William*, b. Jan. 1790, of Worcester; m. (1st), *Mary Lynda Wheeler*, of
 Worcester. He m. (2d) wid. (?) *Mary Evans*.
 33 1. *William Charles*, d. unm.
 34 2. *Harriet Lynde*, m. *Charles Damon*, of Boston.
 35 4. TIMOTHY LINDALL, b. July 15, 1761; grad. Harv. Coll. 1782; Tutor there 1785
 to 1788; M.D. 1824, M.M.S.S.; a physician, of Cambridge. He m., Aug. 24,
 1790, *MARY EMILIA ELIZABETH BELCHER*, of Boston, b. in Halifax, N. S., June
 3, 1760, dr. of Hon. Jonathan Belcher, Jr. (b. in Boston, July 23, 1710, grad.
 Harv. Coll. 1728, Lieut. Gov., and Chief Justice of Nova Scotia), and a gr. dr.
 Gov. Jonathan Belcher [see Danforth, 7, and Geneal. Reg. iii., p. 281]. Her
 mother was Abigail, dr. of Jeremiah Allen, Esq., of Boston. Dr. Jennison d.
 Oct. 19, 1845, aged 84, and his wid. d. Aug. 16, 1848, aged 88. Chil.,
 36 1. *Mary Anna*, b. Aug. 5, d. Aug. 27, 1792.
 2. *William*, b. Ap. 1, 1794, of Camb., unm.
 3. *Andrew Belcher*, b. and d. July, 1795.
 37 4. *Mary Emilia Elizabeth*, b. Oct. 27, 1796; d. Feb. 20, 1853, unm.
 38 5. *Andrew Belcher*, b. Dec. 8, 1798; d. at Baton Rouge, July 12, 1829, unm.
 39 6. *Francis*, b. July 10, 1801; d. May 28, 1826, unm.
 40 7. *Louisa*, b. July 29, 1804; d. July 15, 1843, unm.
 5. ABIGAIL, b. Oct. 31, 1763; d. Dec. 13, 1765.
 41 6. EBENEZER, b. Mar. 27, 1766. In 1780, his father purchased 1000 acres of land
 in Sterlington Plantation [now Union, Me.], and not long after that, as early
 as 1786, he (E.) went there to reside. He taught the first "man's school" in
 Union, in a log house, about 1788. He was a surveyor, and made a plan of the
 town, now in the office of the Sec. of State of Mass. He was selectman, and
 assessor; was the first justice of the peace of the town, appointed 1795. Some
 time after 1802, he moved from Union to Dixmont, Me., where he d. Oct., 1843,
 aged 77. [See Sibley's Hist. of Union.] Chil.,
 42 1. *Ebenezer*, a farmer, of Charleston, Me.
 43 2. *Timothy Lindall*, a carpenter, and farmer, of Dixmont.
 44 3. *Maria Emilia Elizabeth*, m. *Bartlett Jackson*, of East Corinth, Me.
 45 4. A dr. m. — *Wilder*, of Dixmont.
 46 5. A dr. m. —
 47 7. JOHN FLAVEL, b. Sept. 2, 1769; grad. Dart. Coll., 1797; was a teacher of
 music. He m., in Boston, June 13, 1803, *NANCY RAND*, and d. Dec. 12, 1804,
 aged 35.
 8. NATHANIEL, b. Jan. 30, 1772; d. Sept. 25, 1776.
 48 9. ABIGAIL LINDALL, b. Jan. 20, 1776.

4. 49 (V.) THOMAS GILES, of Danvers, m., Nov. 4, 1753, MARY JENNISON. He was b. 1730, younger son of Samuel Giles, of Salem (b. 1694), grandson of Eleazer Giles, and great grandson of Edward Giles, an early settler of Salem, who was adm. freeman May 14, 1634. [See General. Reg. vii., p. 18.] He was in the Battle of Bunker Hill, and d. the next day. His wid. d. 1784. Chil.,
56. 50 1. THOMAS, b. in Danvers, Oct. 6, 1754; five years in the Continental Army; three years in the Continental Navy, and was sailmaker of the Frigate Alliance, in Feb., 1781.
- 51 2. MARY, bap. in Danvers, Feb. 1, 1755 (? 1756); m., after Ap., 1793, S. STEVENS, and settled in Genesee Co., N. Y.; afterwards moved to Indiana, and d. s. p.
108. 52 3. SAMUEL, b. Ap. 6, 1757; enlisted in the Continental Army in 1776; was in the battles of Trenton and Monmouth; shared the sufferings of Valley Forge, and the glories of Saratoga, and continued in the army until 1782.
- 53 4. ABIGAIL, bap. Jan. 21, 1759. 5. ELIZABETH, bap. Nov. 2, 1760, both d. young.
- 53 6. WILLIAM, bap. — 28, 1762; a soldier of the Revolution; m., and settled in Middletown, Conn.: was drowned in attempting to cross Connecticut River, s. p.
- 54 7. JAMES LINDALL, bap. Mar. 30, 1766; m. (1st), Jan. 6, 1794, ANNA PAGE, of Salem. He m. (2d), MARTHA BELLAMY, of Kittery, Me. He d. Jan., 1821, s. p.
- 55 8. ABIGAIL, bap. May 7, 1769; m. (1st) ROBERT WATSON, and resided first in Onondaga Co., N. Y., afterwards in Canada. She m. (2d) ADNA GATES, and resided in Scarborough, near Toronto, C. W. She d. s. p.
-
50. 56 (VI.) THOMAS GILES (a grandson of Rev. Wm. Jennison), m., June 22, 1780, MARY SOPER MARSHALL, b. Aug. 9, 1756, dr. of Zerubabel and Elizabeth (Soper) Marshall, of Boston. In 1786, he settled in Sandy Bay, Gloucester, Mass. [now Rockport], where he d. Nov. 18, 1795, aged 41. His wid. Mary S., d. Sept. 27, 1822, aged 66. Chil.,
- 57 1. BETSEY SNOW, b. in Boston, Mar. 29, 1781; m., Ap. 7, 1800, Dea. JOSIAH VINTON, of Boston, b. July 27, 1777, son of Josiah Vinton, of Braintree. She d. Aug. 9, 1849, aged 68. He has been a prosperous merchant; a deacon, successively in the Essex St. and Phillips Churches of Boston, and now (1853) resides in South Boston. Chil.,
- 58 1. John Adams, b. Feb. 5, 1801; grad. Dart. Coll., 1828; at And. Theol. Sem., 1831; ordained and installed in New Sharon, Me., May 16, 1832; afterwards settled in Chatham, Mass., and Williamstown, Vt.; now (1855) resident of South Boston. He m. (1st), June 6, 1832, *Orinda Haskell*, b. Jan. 14, 1805, dr. of Thomas L. and Orinda Haskell, of Hanover, N. H. She d. Aug. 4, 1838, and he m. (2d), Feb. 24, 1840, *Laurinda Richardson*, b. Oct. 26, 1813, dr. Dea. Reuben and Sarah (Vinton) Richardson, of Stoneham, Mass. Chil.,
1. Edward Payson, b. Feb. 10, 1834. 2. Mary Orinda, b. Feb. 18, 1835. 3. John Francis, b. Oct. 3, 1836; d. Aug. 8, 1847. 4. Arthur, b. Mar. 22, 1841; d. Aug. 25, 1842. 5. Laurinda Ellen, b. Mar. 31, d. Oct. 4, 1843. 6. Alfred Clarence, b. July 16, 1844.
- 59 2. George, b. Aug. 13, 1803; a merchant, formerly of Boston, now of South Hadley, Mass. He m. (1st), Sept. 14, 1826, *Charlotte Williams Callender*, b. Feb. 14, 1802, dr. of Joseph Callender, merchant, of Boston. She d. Aug. 6, 1842, and he m. (2d), Nov. 28, 1844, *Mary Callender*, sister of his first wife. Chil.,
1. Charlotte Ann, b. Jan. 12, 1828. 2. George, b. Feb. 21, 1830; d. Sept. 10, 1831. 3. George, b. July 26, 1831; d. Ap. 22, 1832. 4. Mary Callender, b. Jan. 21; d. July 29, 1835. 5. Mary Callender, b. Ap. 19, 1837; d. Aug. 8, 1852. 6. Sarah Ann, b. June 15, 1839.
- 60 3. *Eliza Ann*, b. Jan. 31, 1806, of S. Boston, unm.
- 61 4. *Nancy Adams*, b. Oct. 26, 1807; m., Nov. 28, 1833, *Wm. Vinton Alden*, a merchant, of Boston, her cousin, b. Aug. 4, 1809, son of Ezra and Abigail (Vinton) Alden, of E. Bridgewater. Chil.,
1. Wm. Edward, b. June 17, 1837. 2. Leonard Case, b. Dec. 22, 1839.
- 62 5. *Mary Marshall*, b. Mar. 30, 1809; d. Oct. 31, 1821.
- 63 6. *Alfred*, b. Dec. 28, 1815; a merchant, of St. Louis; m. *Sarah Martin*, of Lancaster, Penn., s. p.

- 64 7. *Frederick*, b. Oct. 9, 1817; grad. Amh. Coll., 1837; at And. Theol. Sem., 1843; a teacher in St. Louis. He m. Sept. 13, 1843, *Phebe Worth Clisby*, ar. of Seth and Elizabeth Clisby, of Nantucket.
- 65 8. *Harriet Newell*, b. Mar. 8, 1819; of South Boston, unm.
- 66 2. MATTHEW SMITH, b. in Boston, Aug. 16, 1784; settled in Rockport, Mass., formerly devoted to seafaring life. He m. (1st), Dec. 14, 1806, SALLY WEBSTER, of Rockport. She d. Mar. 6, 1840, aged 57, and he m. (2d), Mar. 22, 1841, wid. LYDIA (Lee) CLIFFORD, of Wenham, Chil.,
- 67 1. *Matthew*, b. Nov. 28, 1807; a cabinet-maker, of Manchester, Mass.; m., May 30, 1831, *Harriet Allen*, b. Dec. 14, 1807. Chil.,
1. *Eliza*, b. Oct. 22, 1832. 2. *Harriet Atwood*, b. Aug. 23, 1834.
3. *John James*, b. July 20, 1836. 4. *Sarah Webster*, b. Aug. 10, 1839.
5. *Anna Allen*, b. Ap. 5, 1841. 6. *Wm. Darius*, b. July 22, 1843.
7. *Mary Dodge*, b. Jan. 21, 1846. 8. *Lydia Smith*, b. Nov. 13, 1850; d. Mar., 1851.
- 68 2. *John James*, b. Feb. 1, 1810; a seafarer, of Rockport; m. (1st) *Betsy Lane*, of Rockport. He m. (2d) *Margaret Somes Stockman*, of Rockport. He m. (3d) *Catherine A. M^r Farland*, of Fonda's Bush, a village near Johnstown, N. Y. Chil.,
1. *Margaret*. 2. *Mary*. 3. *Catherine Ann*, b. 1848; d. 1852.
- 69 3. *William*, b. Nov. 14, 1812; d. July 19, 1834, unm.
- 70 4. *Darius*, b. Jan. 23, 1815; d. Ap. 12, 1842, unm.
- 71 5. *Lydia Dodge*, b. Dec. 23, 1817; m., Feb. 15, 1838, *Jabez Richardson*, of Rockport. He d. June 7, and she d. June 22, 1843. 1 child, d. in infancy.
- 72 6. *Alfred*, b. July 31, 1820; a cabinet-maker, of Rockport; m., Nov. 6, 1846, *Eliza Jane Torrey*, of R. Chil., 1. *Alfred*. 2. *Charles Hale*.
- 73 7. *Mary*, b. Oct. 22, 1822; d. Oct. 20, 1840, unm.
8. *Calvin*, b. Aug. 24; d. Sept. 28, 1828.
- 74 3. THOMAS, b. in Boston, Nov. 16, 1785; of Rockport, since Ap., 1786; in early life a fisherman, afterwards engaged in trade, and since 1837, an agriculturist; a deacon of the Orthodox Cong. Church. He m. (1st), Aug. 9, 1808, OLIVE TARR, dr. of Benjamin and Lucy (Pool) Tarr, of Rockport. He m. (2d), Jan. 3, 1833, MARY HOLMES, b. July 10, 1796, dr. of Robert Holmes, of Dunstable, N. H. Chil.,
- 75 1. *Thomas*, b. Mar. 20, 1809; a sea-captain, accidentally knocked overboard and drowned Mar. 9, 1832, unm.
- 76 2. *Samuel Jennison*, b. Nov. 15, 1811; a trader, of Rockport; m. there June 6, 1835, *Elizabeth Leonard*, of Kingsboro, N. Y., b. Dec. 5, 1813. Chil.,
1. *Newell*, b. in St. Johnsville, N. Y., May 25, 1837.
2. *Mary Olive*, b. in Kingsboro, N. Y., Mar. 5, 1841.
3. *William Henry*, b. in Gloversville, N. Y., Feb. 10, 1844.
4. *Newton Leonard*, b. in Rockport, Nov. 26, 1851.
- 77 3. *Benjamin*, b. Feb. 1, 1816; two years a member of Dart. Coll.; a teacher many years in Rockport, now in Beverly; a deacon of the Orthodox Cong. Church, in Rockport. He m., Nov. 30, 1843, *Susan Bartlett Haskell*, of Rockport, b. Ap. 22, 1824. Chil.,
1. *Lorenzo Tarr*, b. Ap. 4, 1847; d. Aug. 30, 1848.
2. *Susan Adeline*, b. Ap. 12, 1850.
- 78 4. *Newell*, b. Feb. 14, 1818; a trader, of Rockport; m., Nov. 28, 1844, *Elizabeth Whipple Gott*, b. July 5, 1820, dr. Dea. Jabez R. Gott, of Rockport. Chil.,
1. *Ellen Elizabeth*, b. July 5, 1847; d. Feb. 28, 1851.
2. *Mary Greenwood*, b. Sept., 1850.
- 79 5. *George Vinton*, b. Mar. 26, d. Sept. 10, 1820.
- 80 6. *George Vinton*, b. Jan. 1, 1822; d. Sept. 7, 1842.
- 80 7. *Olive*, b. Feb. 9, 1824; m., Dec. 18, 1847, *Nathaniel Tarr*, of Rockport, now of Boston, son of Nathaniel and Mary Tarr; dr. Olive Geneva, b. Mar. 24, 1852.
- 81 8. *Lucy*, b. Sept. 26, 1826. 9. *Thaddeus*, b. Feb. 27, 1829.
- 82 10. *Susan Elizabeth*, b. Oct. 28, 1833. 11. *Walter Harris*, b. Oct. 6, 1837.
- 83 4. MARY, b. Sept. 3, 1787; m., Aug. 16, 1804, DANIEL SMITH TARR, son of Benjamin Tarr, of Rockport. He d. Aug. 12, 1813, and she remains a widow. Chil.,
- 84 1. *Abigail Giles*, b. Mar. 3, 1805; m., May 12, 1824, her cousin, *Fitz Tarr*, of Rockport. Chil.,

- 85 1. Mary Abigail, b. Sept. 29, 1826, d. July 30, 1832.
2. Fitz William, b. May 30, 1828; m., Nov. 14, 1850, Frances Ingalls, of Bridgeton, Me.
- 86 3. Laurana, b. July 28, d. Nov. 3, 1830.
4. Daniel Smith, b. July 29, 1832.
- 87 5. Jabez, b. Dec. 18, 1834, d. Feb. 6, 1835.
- 88 6. Mary Abigail, b. Dec. 6, 1836.
2. Daniel Smith, b. Mar. 12, 1807; a cabinet-maker, and a manufacturer of deerskin gloves, in Gloversville, N. Y.; m. (1st), Aug. 19, 1830, *Charlotte M. Case*, dr. of Elisha Case, of Kingsboro, N. Y. She d. Nov. 8, 1837, aged 31, and he m. (2d), Oct. 16, 1838, *Nancy Case*, dr. of Darius Case, of Kingsboro, N. Y. She d. Ap. 25, 1846, aged 40, and he m. (3d), Ap. 1, 1847, *Abigail L. Heacock*, of Kingsboro. Chil., 1. Son, d. aged 2 weeks.
2. Jerusha, b. Ap. 26, 1833. 3. Eliza Vinton, d. soon. 4. Helen Maria, b. Sept. 1845. 5. David Henry, b. May 8, 1848. 6. Daniel Edward, b. Mar. 13, 1850.
3. Laurana Giles, b. Jan. 7, 1810, d. June 8, 1830.
4. Mary Eliza, b. Oct. 6, 1811, d. May 8, 1812.
5. David, b. June 1, 1813, d. Feb. 20, 1814.
- 89 5. SAMUEL, b. Aug. 22, 1789; a mariner, of Rockport; m., Mar. 14, 1811, wid. MARGARET (DAVIS) NORWOOD, of Rockport, b. Oct. 21, 1790. Chil.,
- 90 1. Olive, b. Oct. 11, 1811; m., Nov. 27, 1831, *Stephen Andrews*, of Rockport. 2 chil., both d.
- 91 2. *Azubah Prentiss*, b. Ap. 16, 1813; m., Mar. 18, 1833, *Nathan Franklin Burr*, of Kingsboro, N. Y. Chil., 1. Lucius Franklin. 2. Stephen Norwood, 3. Thaddeus Giles. 4. Julius Henry. 5. Ellen Calista. 6. Julius Henry. 7. Wilbur Jason. 8. Harriet Mills. 9. Samuel Giles. 10. Mary Laurana. 11. Nathan Henry.
3. Samuel, b. Sept. 4, 1815, d. June 25, 1817.
4. Margaret, b. May 17, 1817, d. Ap. 8, 1819.
- 92 5. Margaret, b. Feb. 28, 1819; m., Nov. 28, 1844, *William Foster*, of Rockport. 1. Betsey Marshall, b. Mar. 1846.
- 93 6. *Mary Marshall*, b. Oct. 3, 1821; m., Feb. 9, 1848, *Thomas Woodbury Knowlton*, of Boylston, Mass., now of Worcester.
7. Samuel, b. Jan. 27, 1824, d. Oct. 7, 1825.
8. Child, b. Sept., d. Oct., 1825.
- 94 9. Laurana Tarr, b. Nov. 5, 1826; m., Jan. 31, 1849, her second cousin, *William W. Marshall*, of Rockport.
- 95 10. *Lucy Elvira*, b. Dec. 7, 1828; m., July 10, 1851, her cousin, *Eben Giles*, son of William [see 99].
- 96 11. Jason, b. Nov. 28, 1830.
12. *Sarah Beach*, b. Dec. 30, 1833, d. Oct. 22, 1837.
6. ABIGAIL, b. July 11, 1791, d. Jan. 31, 1799.
- 97 7. WILLIAM, b. Sept. 16, 1793; a mariner, of Rockport; m., 1814, HANNAH GOTT, dr. of Ebenezer Gott, of R. Chil.,
1. William, b. Aug. 1815, d. Sept. 1826.
- 98 2. James, b. June, 1817; m., Oct. 1849, *Hannah E. Long*, of Whitefield, Me.
- 99 3. Eben, b. June, 1819; m., July 10, 1851, his cousin, *Lucy E. Giles* [see 95].
- 100 4. *Jabez Gott*, b. Oct. 1821, unm.
- 101 5. *Elizabeth*, b. Aug. 1823, d. Nov. 14, 1847; m., Dec. 31, 1844, *William Goss*.
- 102 6. *Laura*, b. Jan. 10, 1826. 7. *Hannah Jewett*, b. Feb. 10, 1829.
- 104 8. *William*, b. Sept. 1831, d. June, 1833. 9. *Frederick*, b. July 3, 1835.
- 105 10. *Newell*, b. Ap. 1837. 11. *Eliza*, b. Nov. 1839. 12. *George*, b. Aug. 1841.
52. 108 (VI.) SAMUEL GILES, m., Jan. 8, 1783, in Windsor Co., Vt., LAURANA HOLMES, b. in Pembroke, Mass. In Mar. 1792, he moved from Windsor, and settled permanently in Kingsboro, Fulton Co., N. Y. He was a deacon of the Cong. Church, and of eminent piety. He d. Oct. 30, 1841, aged 84, and his wid. d. Oct. 23, 1850. Chil.,
1. LEMUEL, b. July 5, d. July 20, 1784.
- 109 2. JENNISON, b. Sept. 5, 1785; a tanner, currier, and farmer, of Kingsboro; m. (1st) Sept. 24, 1806, *PHILENDA BEACH*, dr. of Amos Beach, of K. She d. in childbed Dec. 28, 1821, aged 36. He m. (2d), July 17, 1822, *PRUDENCE HATCH*, of Sherburne, N. Y. Chil,

- 110 1. *Samuel Lindall*, b. Nov. 14, 1807, d. Sept. 28, 1808.
 2. *Albert*, b. May 10, 1809; a physician, of Racine, Wis.; m., Jan. 1836, *Ann Osborn*, of Troy, N. Y. Chil.,
 1. *Frances Mary*, b. Nov. 1836. 2. *Willard Parker*, b. 1839, d. 1841.
 3. *Martha Ann*, b. Sept. 1840. 4. *Jane Sophia*, b. 1843.
 5. *James Albert*, d. in childhood.
- 111 3. *Laurana*, b. June 3, 1811; m. Oct. 8, 1831, *Ebenezer Rowe*, of Rockport Mass., s. p.
- 112 4. *Orsamus Holmes*, b. Ap. 6, 1814; drowned in a tan-vat, July 19, 1816.
- 113 5. *James Jennison*, b. Jan. 9, 1816, d. Oct. 1846, unm.
- 113 6. *Amos Beach*, b. July 14, 1818; a merchant, of Cherry Valley, Otsego Co., N. Y.; m., June 5, 1849, *Harriet Newell Wadsworth*, of Westford, Otsego Co., N. Y. Son *Henry Wadsworth*, b. July 8, 1851.
- 114 7. *John Adams Vinton*, b. Dec. 14, 1821; a merchant, of Cherry Valley, N. Y.; m. Dec. 18, 1850, *Elizabeth M'Donald*, of Gloversville, N. Y. Daughter, *Francis Eugenia*, b. Jan. 20, 1852.
- 115 3. *MARY*, b. July 23, 1787; m., Dec. 30, 1807, *HENRY DUBOIS LOUNSBERY*. She d. Ap. 23, 1813, and he d. Oct. 1846. Chil.,
- 116 1. *Samuel Giles*, b. Nov. 14, 1808, of Euclid, Onondaga Co., N. Y.; m., about 1831, *Harriet S. Kinney*. He d. June 1841. Chil.,
 1. *Mary Giles*, b. June, 1833. 2. *Edward Henry*, b. June, 1835.
 3. *Sarah Beach*, b. Ap. 1837. 4. *Amanda Hale*, b. Feb. 1839.
 5. *Samuel Giles*, d. of croup, aged 5 years.
- 117 2. *Edward*, b. Jan. 3, 1811; Rector of St. Jude's Episcopal Church, Philada.; m., Ap. 19, 1844, *Anne Maria Vosburg*, his cousin, of N. Y. city. Chil.
 1. *Louisa Brooke*, b. in Ky., Mar. 6, 1845, d. Mar. 7, 1847.
 2. *Edward Leighton*, b. in Troy, Jan. 4, 1847.
 3. *Willard*, b. in Troy, Aug. 13, 1850, d. Mar. 25, 1851.
 4. *Dubois*, b. in T., Jan. 27, 1853.
- 118 3. *Mary Giles*, b. Mar. 20, 1813; m., 1835, *Rufus Hosmer*; d. Mar. 1845, s. p.
- 119 4. *SARAH*, b. May 26, 1792; m., Ap. 5, 1825, *AMOS BEACH*, of Kingsboro, N. Y. Chil.,
- 120 1. *Giles*, b. May 29, 1826; an organ-builder; m., June 24, 1851, *Charlotte Camilla Smith*, of Kingsboro.
-
- 121 (IV.) *JOHN JENNISON*, b. in Wat., Feb. 19, 1710-11, son of *Samuel* and *Mary* (Stearns) *Jennison*, m. in Lunenburg, July 21, 1740, *MARY HUBBARD*, b. in Groton, Ap. 12, 1725, dr. of *Major Jonathan* and *Rebecca* (Brown) *Hubbard*, first of Groton, afterwards of Townsend, Mass. He d. 1751. Inventory (£205) dated Nov. 27, 1751. His wid. *Mary* m. Col. *Benjamin Bellows*, of Walpole. [See pp. 308 and 532, and *Hubbard*, [27,] p. 797.]
-
134. 122 1. *MARY*, b. Mar. 12, 1741-2, m. *Major JOSIAH WILLARD*.
- 123 2. *JOHN*, b. June 15, 1744, a farmer and a captain, of Walpole, N. H.; m. (1st), in 1767, *KEZIA SPRING*, b. Oct. 21, 1745, dr. of *Josiah* and *Catherine Spring*, of Ashford, Conn. [See *Spring*, 43, and Part II.] She d. Ap. 10, 1771, aged 26, and he m. (2d), May 6, 1772, *SYBIL BISHOP*, of Woodstock, Conn. He d. Oct. 16, 1804. Chil.,
- 124 1. *Josiah*, b. Nov. 1. 1767; m., in Savannah, Ga., Ap. 22, 1792, *Ann*, dr. of *Charles Francis Chevalier, Esq.* He was appointed inspector of customs of Savannah, Sept. 12, and d. there Nov. 2, 1792, leaving, it is supposed, a posthumous son.
180. 125 2. *Samuel*, b. Aug. 29, 1769, of Wethersfield and Windsor, Vt.
 (By 2d wife, Sybil.)
201. 126 3. *John*, b. Feb. 7, 1773, of Sackett's Harbor, N. Y.
219. 127 4. *Rebecca*, b. Aug. 13, 1774; m. *Elijah Kilborn*.
267. 128 5. *Mary*, b. Dec. 7, 1777; m. *Solomon Godfrey*.
283. 129 6. *William*, b. Dec. 29, 1778, of Walpole.
298. 130 7. *Lucinda*, b. Sept. 3, 1780; m. *Prosper Booth*.
323. 131 8. *Levi*, b. Dec. 13, 1781, of Walpole.
- 132 3. *REBECCA*.
332. 133 4. *JONATHAN*, of Walpole.
 5 and 6 d. in infancy.

122. 134 (V.) Major JOSIAH WILLARD, of Keene, N. H. [?son of Col. Josiah. See Hubbard, 22, p. 797.] He m., about 1770, MARY JENNISON [122], his 2d wife. She d. in childbed, July 20, 1779, and he m. (3d) SUSANNAH WYMAN, who d. Oct. 25, 1785. He d. June 29, 1801, aged 64.
- (Chil. by 2d wife, Mary.)
- 135 1. REBECCA, b. May 24, 1772; m., June 24, 1790, JOHN STIMPSON, of Wat., his 2d wife. 2 drs., 1. *Hannah*. 2. *Rebecca*.
- 136 2. HANNAH, b. Jan. 14, 1774; m., Sept. 5, 1790, JOSHUA WYMAN, of Keene, b. Jan. 9, 1769, son of Col. Isaac Wyman. Chil.,
- 137 1. *Mary Jennison*, b. Dec. 4, 179-; m. *Silas Perry*. She d. 1844.
1. Franklin R., b. 1823. 2. Mary Louisa, b. 1825. 3. John H., b. 1827.
4. Josiah W., b. 1829. 2 of the sons in Texas.
- 138 3. JOSIAH, b. Jan. 9, 1778; a Major, a mechanic, some time of Keene, now (1854) of Needham, Mass.; m., 1799, BIAL WELLMAN. He m. (2d), Oct. 27, 1805, PRUDENCE MORSE. Chil.,
- 139 1. *Henry*, b. Aug. 14, 1799; a machinist, of Keene; m., June 22, 1822, *Sarah Perry*, of Keene. Chil.,
- 140 1. Lafayette, b. Ap. 29, 1823; a mechanic, of Keene; m., Nov. 10, 1847, Anna Bradford.
- 141 2. Sarah Ann, b. Jan. 8, 1826.
- 142 3. Marietta Keep, b. Oct. 8, 1828; m., Oct. 8, 1849, Wm. R. Marsh, inn-keeper, Northampton, Mass.
- 143 4. Henry Clay, b. Sept. 30, 1829.
- 144 5. Catherine Hale, b. Oct. 31, 1831; m., in 1851, Joseph R. Pettengill, a machinist, of Worcester, Mass.
- 145 6. Edwin Thompson, b. Sept. 9, 1833; d. Mar. 9, 1836.
- 146 7. Caroline Eliza, b. June 9, 1836. 8. Bial Wellman, b. May 4, 1839.
- 148 9. George Clarence, b. Sept. 29, 1842.
- 149 2. *Eliza*, b. Sunday, Jan. 1, 1801 (the first day of the first week of the first month of the first year of the century); d. aged 2 yrs.
- 150 3. *Josiah*, b. 1803, d. soon. 4. *Mary Jennison*, b. Aug. 7, 1804.
(Chil. by 2d wife, Prudence.)
- 151 5. *Josiah*, b. July 9, 1806; d. 1833. 6. *Charles Morse*, b. July 31, 1808, m. *Mary Ross*.
- 153 7. *Hannah*, b. July 31, 1810; m. *Jacob R. Furwell*, of Wilton, Me., boot and shoe dealer, of Boston.
- 154 8. *Edward*, b. July 21, 1812; of Wilton, Me.; m. *Martha Dunn*.
- 155 9. *Abigail Rebecca*, b. Sept. 15, 1814; m. *Stephen F. Harvey*.
- 156 10. *Catherine*, b. 1819; m. *Wm. How*.
- 157 11. *James Dascom*, b. 1821; d. 1844. 12. *Sarah M.*, b. 1824; d. 1834.
- 159 13. *Emily W.*, b. 1826; d. 1842. 14. *Lucian F.*, b. Mar. 30, 1830.
- 161 4. HENRY, b. July 20, 1779; a merchant, of Washington, N. H.; m., in 1804, LOVEY ADAMS, of Keene. He d. in Feb., 1815, of malignant spotted fever, and his wid. survived him only a week, dying of grief. Chil.,
- 162 1. *Mary*, b. May 12, 1805; d. 1827.
- 163 2. *Catherine Hannah*, b. Jan. 1, 1807, adopted by her uncle, Nathaniel Adams, Esq., of Charlestown, Mass., and name changed from Willard, to Adams, by legal enactment; m., June 12, 1832, *George Adams Kettell*, Esq., of Charlestown, now (1854) Treas. of the Northern Railroad. Chil.,
- 164 1. *Mary Soley*, b. Ap. 21, 1833. 2. *Catherine Hannah*, b. Nov. 4, 1835.
- 166 3. *Henry Augustus*, b. Feb. 8, 1838. 4. *Frances Elizabeth*, b. Oct. 16, 1841.
- 168 5. *Louisa Cary*, b. Nov. 11, 1843. 6. *George Adams*, b. May 10, 1846.
- 170 7. *Charles Willard*, b. Nov. 3, 1848. 8. *Helen Lee*, b. Mar. 1, 1851.
- 172 3. *Joseph Henry*, b. Sept. 27, 1808; d. Aug., 1833.
- 174 4. *Elisha Wheeler*, b. May 22, 1810; went to the West in 1833, and there m. *Mary Ellen Estabrook*. He is a partner in the banking-house of George Smith & Co., of Chicago. Chil., 1. *Julia*, b. 1837; d. soon. 2. *Joseph Henry*, b. 1843. 3. *Mary Adams*, b. Oct., 1851.
- 176 5. *Martha Lawrence*, b. Sept. 17, 1812; m., Feb., 1837, *Charles Hunter Jackson*, Esq., Commander, in U. S. Navy, resident of Middletown, Conn. Chil.,
- 177 1. *Catherine Teresa*, b. 1840. 2. *Mary Alsop*.

- 179 3. Martha Lawrence. 4. Alice Fenwick.
6. Sarah, b. 1814; d. 1821.
5 and 6, two children d. in infancy.
-
125. 180 (VI.) SAMUEL JENNISON; a mason, of Wethersfield, and Windsor, Vt., afterwards of Peru, Ia.; m., in Wethersfield, in 1802, RUTH PORTER STEELE, b. in Wethersfield, June 8, 1784. He d. in Peru, Ia., Feb. 2, 1835, and his wife, Ruth, d. in Pike Co., O., July 16, 1834. Chil.,
- 181 1. OZRO P., b. Oct. 20, 1802; a civil engineer, has resided at Circleville, and Rockville, O., and at Indianapolis and Crawfordsville, Ia.; m., in Circleville, Oct. 7, 1830, MARGARET McMASTER, b. Jan. 27, 1809, at Mount Pleasant, Penn., dr. of John and Mary (Cunning) McMaster. Chil.,
- 182 1. *Mary Elizabeth*, b. Aug. 23, 1831; m., at Crawfordsville, Ap. 13, 1852, *John Lindsay Herndon*, a R.R. conductor, son of Dr. Milton Herndon, of C.
- 183 2. *Martha Louisa*, b. May 19, 1833; d. at Oskaloosa, Iowa, Oct. 23, 1854; m., Oct. 31, 1853, *Lurton Dunham Ingersol*, a teacher, at Mount Pleasant, Iowa, son of Stephen Ingersol, hotel-keeper, of Crawfordsville; in 1855, editor of a newspaper at Oskaloosa.
- 184 3. *Samuel McMaster*, b. Jan. 10, 1836; d. Sept., 1838.
- 186 4. *Susan Williams*, b. Jan. 8, 1838. 5. *Fannie Hubbard*, b. July 11, 1840.
- 186 6. *Albert Cunningham*, b. Aug. 17, 1842. 7. *Henry Steele*, b. Aug. 9, 1846.
2. ELOISA, b. May 26, 1804; d. Mar. 16, 1815.
3. GEORGE HUBBARD, b. July 28, 1806; d. Mar. 17, 1815.
- 188 4. HENRY QUARTUS, b. Oct. 17, 1810; a Colonel, and merchant, of Muscatine, Iowa; m., in Pike Co., O., Mar. 5, 1833, MARY BEAL STEINBERGER. Chil.,
- 189 1. *Rebecca Knapp*, b. Jan. 19, 1834; m., Jan. 19, 1854, *Joseph B. Cass*, a merchant, in Muscatine.
2. *Lucy Ellen*, b. Aug. 25, 1837; d. Aug. 20, 1838.
3. *Wm. Henry*, b. Sept. 10, 1839; d. July 17, 1841.
- 190 4. *Charles*, b. Sept. 2, 1841. 5. *Walter*, b. Mar. 3, 1844.
6. *Henry*, b. Jan. 23, d. Feb. 28, 1848.
7. *Mary Bell*, b. May 1, 1849; d. July 17, 1852.
8. *Louisa*, b. May 17, 1852.
- 192 5. LOUISA MARION, b. Sept. 14, 1816; d. July 26, 1842; m., in Rockville, O., Sept. 1833, ROBERT JAMES PRESTON, merchant, of Augusta, Ky., now of California.
- 193 Chil.,
- 194 1. *Mary Louisa*, b. Feb. 6, 1835. 2. *Catherine Porter*, b. Jan., 1837; d. 1843.
- 195 3. *James M Cowan*, b. Feb. 6, 1839. 4. *Richard Millen*, b. Dec. 7, 1841.
- 197 6. GEORGE HUBBARD, b. Dec. 15, 1819; a minister of the Meth. Ep. Church, now of Anamosa, Iowa; m., in Fairfield, Iowa, Jan. 16, 1843, ADALINE PHENEGAR. Chil.,
- 198 1. *Alice Gray*, b. Nov. 17, 1843. 2. *Mary Elizabeth*, b. Nov. 26, 1847; d. 1851.
- 198 3. *Louisa Preston*, b. Oct. 21, 1850. 4. *Joseph Hawkins*, b. July 14, 1853.
- 199 7. JOHN SPRING, b. Dec. 13, 1823; a mechanic, of Cincinnati; m., in C., Aug. 18, 1852, ELIZABETH AMANDA MONJAR.
- 200 8. JAMES STEELE, b. Aug. 18, 1825; printer, and publisher of a newspaper in Marion, Iowa; m., in Cincinnati, Mar. 19, 1849, FRANCES BARKER.
-
126. 201 (VI.) JOHN JENNISON, resident of Sackett's Harbor, N. Y., employed in town and county offices. He m., in Walpole, N. H., Mar. 18, 1794, POLLY GAGE. She d. Sept. 11, 1837. Chil.,
- 202 1. JOHN HUBBARD, b. Feb. 15, 1795; a book-keeper in a foundry, in Buffalo, N. Y., where he d. Dec. 17, 1846; m., in Pembroke, N. Y., Feb. 22, 1818, SARAH F. SAWYER. Chil.,
- 203 1. *Sarah Adaline*, b. Ap. 17, 1819; d. Sept. 1, 1852; m., Jan. 1, 1838, *Walter Campbell*, an engineer. 2 sons.
- 204 2. *Hannah Sophia*, b. Nov. 3, 1821; m., Jan. 1, 1850, *Jacob L. Hilliker*, a house-joiner.
- 205 3. *La Fayette*, b. Oct. 21, 1824; a farmer; m., Mar. 31, 1851, *Henriette Cook*.
- 206 4. *Mary Jane*, b. May 15, 1828; m., June 13, 1849, *Albert M. Waterman*, a merchant.

- 207 5. *Emma Caroline*, b. Jan. 30, 1836. 6. *Harriet Augusta*, b. Oct. 7, 1842.
- 209 2. *RODERICK*, b. Ap. 15, 1796; of Monroe, Green County, Mich.; has had two wives and 3 sons.
- 210 3. *JOSIAH*, b. Feb. 13, 1798; d. in Oswego, N. Y., 1849, leaving a wife, three sons, and one daughter.
- 211 4. *HARRY*, b. Feb. 16, 1800, of Niles, Mich., where he d. in 1847, leaving a wife and two sons.
- 212 5. *ALONZO*, b. Mar. 22, 1803; of Sackett's Harbor; wife and 1 son.
- 213 6. *MARY ADALINE*, b. July 2, 1809; m., at Sackett's Harbor, Dec. 10, 1829, *CHESTER MELLE*n, formerly a merchant of Sackett's Harbor, now Sutler to the U. S. Troops at Old Point Comfort, Va. Chil.,
- 214 1. *George Chester*, b. Ap. 11, 1831. 2. *Sophia Adaline*, b. Sept. 6, 1832.
- 216 3. *Mary Clitz*, b. Oct. 1, 1842.
- 217 7. *WILLIAM HENRY*, b. Ap. 25, 1815, of N. Y. city; m., Oct. 8, 1840, *MARY CHEESEBRO*, of New Haven, Oswego Co., New York. 2 drs.,
1. *Helen Mary*, b. in Oswego, Oct. 7, 1841.
2. *Sarah Cheesebro*, b. in Brooklyn, N. Y., Jan. 27, 1847, d.
- 218 8. *GEORGE*, b. Aug. 3, 1821, of N. Y. city; m., Nov. 24, 1847, *MARY NYE*, of Sandwich, Mass. One son,
1. *George Augustus*, b. in New York, Oct. 19, 1851.
-
127. 219 (VI.) *ELIJAH KILBURN*, a carpenter, of Walpole, N. H., son of John, Jr., and grandson of John Kilburn, Sen., the first settler of Walpole; m., Feb. 11, 1798, *REBECCA JENNISON*. He d. Mar. 19, 1847, and she d. Jan. 20, 1849. Chil.,
- 220 1. *HARRIET*, b. June 19, 1799, d. Ap. 8, 1830.
- 221 2. *JOSIAH*, b. Jan. 2, 1801; formerly a farmer, now a machinist, of Littleton, N. H., and Rep. in N. H. Legislature; m., Mar. 1, 1827, *EMILY BONNEY*, of Littleton. Chil.,
- 222 1. *Benjamin West*, b. Dec. 10, 1827; m., Nov. 16, 1853, *Carrie L. Burnham*.
- 223 2. *Edward*, b. Feb. 27, 1830; m., May 10, 1851, *Adaline S. Owen*.
- 224 3. *Emily Bonney*, b. Oct. 17, 1833; m., Dec. 28, 1853, *James Dow, Jr.*
- 225 3. *MARY HUBBARD*, b. Jan. 15, 1802; m., in Walpole, July 15, 1825, *NOAH SMITH*, an iron founder, of Fullersville, N. Y. Chil.,
- 226 1. *Mary Jane*, b. Ap. 29, 1826; m., May 11, 1846, *Justice O. Rose*. 3 chil.,
1. *George W.* 2. *Mary Elizabeth*. 3. *Justice*.
- 227 2. *Harriet Rebecca*, b. Feb. 10, 1828; m., May 8, 1853, *Thomas Cary*.
- 228 3. *Eliza Ann*, b. Ap. 4, 1830; m., Jan. 21, 1850, *Carlisle D. Wait*.
- 229 4. *Phæbe Maria*, b. May 1, 1832. 5. *John Windsor*, b. Mar. 30, 1834.
- 231 6. *Martha Ellen*, b. Mar. 20, 1836. 7. *Katherine Augusta*, b. Ap. 16, 1839.
- 233 8. *William Rodney*, b. Dec. 14, 1842.
- 234 4. *GEORGE*, b. Dec. 1, 1803; a mechanic, of Walpole, afterwards a manufacturer, of Fall River, Mass., now (1854), superintendent of a cotton factory, at Lonsdale, R. I.; m., in Walpole, Dec. 18, 1825, *LAURA HOOPER*. Chil.,
- 235 1. *Hiram*, b. Nov. 9, 1826; m., July 19, 1847, *Harriet Ellen Sherman*.
- 236 2. *Ellen*, b. July 10, 1828; m., May 16, 1849, *George A. Kent*.
- 237 3. *John*, b. Aug. 5, 1830; m., Oct. 19, 1852, *Amanda Maria Whitman*.
- 238 4. *Edward*, b. Aug. 2, 1832; m., May 18, 1854, *Elnora Adams*.
- 239 5. *Harriet*, b. Aug. 31, 1834. 6. *George William*, b. Dec. 14, 1836, d. 1840.
- 241 7. *Laura Rebecca*, b. Jan. 7, 1839. 8. *Emeline Hooper*, b. Aug. 25, 1841.
- 243 9. *Mary Louisa*, b. Mar. 9, 1846. 10. *Elizabeth Fry*, b. July 20, 1848.
- 245 5. *JOHN JENNISON*, b. Feb. 21, 1808, keeper of a public house in Boston, afterwards a machinist of Fall River, where he d.; m., Jan. 11, 1831, *MARIA ELIZABETH GAGE*. Chil.,
- 246 1. *Louisa Rebecca*, b. July 12, 1833. 2. *Edward Jennison*, b. Mar. 17, 1836.
- 248 3. *Maria Augusta*, b. May 19, 1839. 4. *Charles Henry*, b. Mar. 20, 1843.
- 250 5. *Helen Elizabeth*, b. Oct. 27, 1845.
- 251 6. *FREDERICK*, b. Ap. 4, 1809; a farmer and mechanic, formerly of Littleton, now of Walpole, N. H.; m., June 29, 1835, *MARY ANN WATKINS*, of Walpole. Chil.,
- 252 1. *Ann Rebecca*, b. July 24, 1836. 2. *Mary*. 3. *Maria* (twins), b. Aug. 5, 1838.
- 255 4. *Frederick Sherman*; and 5. *Franklin Jennison* (twins), b. Mar. 11, 1849.

- 257 7. ELIJAH CARPENTER, b. June 10, 1811; Rep. of Walpole; now (1854), a machinist, of Fall River; m., in Boston, Sept. 24, 1835, Mrs. HANNAH S. (Carter) UPHAM, of Boston. Chil.,
- 258 1. *Emily Annah*, b. Ap. 1, 1839. 2. *Mary Theresa*, b. Aug. 3, 1841.
- 260 3. *Charles W.*, b. July 12, 1844. 4. *Ella T.*, b. June 21, 1850.
- 262 8. REBECCA, b. Aug. 21, 1815; m., Oct. 20, 1841, RODNEY SMITH, a paper manufacturer, of Hadley, Mass. Chil.,
- 263 1. *Elizabeth Rebecca*, b. Nov. 7, 1842, d. Feb. 23, 1847.
- 264 2. *Mary Ellen*, b. Mar. 4, 1845. 3. *Wm. Henry*, b. July 27, d. Aug. 17, 1848.
- 266 4. *Maria May*, b. Nov. 27, 1850. 5. *Arthur*, b. Sept. 18, 1852.
9. WM. JENNISON, b. Sept. 21, 1819; a merchant, of Augusta, Me., unm.
-
128. 267 (VI.) SOLOMON GODFREY, a blacksmith, of Walpole, afterwards of Langdon, N. H.; m. Sept. 20, 1801, MARY JENNISON. He d. in Rochester, N. Y., Nov. 8, 1848. Chil.,
- 268 1. SARAH MARIA, b. Feb. 28, 1802; m., May 26, 1830, WILLARD S. CHURCH, a farmer, of Northfield, Mass., s. p.
- 269 2. CLEMENT JENNISON, b. Nov. 14, 1803, a button manufacturer, of Waterbury, Conn.; m., May 13, 1834, MARY BOLTWOOD COOLEY, of Amherst, Mass.
- 270 1. *William Henry Kellogg*, b. May 14, 1839.
- 271 3. CAROLINE FRANCES, b. Jan. 8, 1806; m., Aug. 11, 1830, LEANDER GOODWIN, a merchant, of Forsyth, Ga., afterwards of Cassville; was quartermaster in the Florida War; d. in Cassville, Sept. 16, 1848. Chil.,
- 272 1. *Leander Clement*, b. May 16, 1832. 2. *Francis Henry*, b. Ap. 23, 1834.
- 274 3. *Maria Louisa*, b. Oct. 18, 1835. 4. *Charles Lorin*, b. Jan. 29, 1843.
- 276 4. ELEANOR ANN, b. Aug. 29, 1810; m., Ap. 19, 1830, IRA WALDO, a carriage manufacturer, of Rochester, N. Y., s. p.
- 277 5. HENRY NELSON, b. Feb. 14, 1814; partner in business with his brother Clement, m., Jan. 1, 1839, NANCY COCHRAN MARTIN, of Landgrove, Vt.
- 278 1. *Marcus Martin*, b. May 24, 1843. 2. *Maria Louisa*, b. Mar. 18, 1847.
- 280 6. MARY ISABELLA, b. Oct. 30, 1819; m., Ap. 29, 1840, LEVI S. WYMAN, a farmer, of Landgrove, Vt., where he d. July 8, 1853. Chil.,
- 281 1. *Eugene S.*, b. Sept. 30, 1841, d. July 17, 1842.
2. *Eugene S.*, b. May 29, 1843. 3. *Eudora Isabella*, b. Mar. 10, 1847.
-
129. 283 (VI.) Major WILLIAM JENNISON, a farmer, of Walpole, N. H.; m., Dec. 14, 1804, PHEBE FIELD, dr. of James and Mary (Woodcock) Field, of Nelson, N. H.
- 284 1. EDWIN, b. Aug. 26, 1805; grad. Dart. Coll. 1827; at And. Theol. Sem. 1830; ordained Pastor of the Cong. Church in Walpole, Aug. 17, 1831; dismissed on account of ill health, Mar. 17, 1835; subsequently settled and dismissed on the same account, in Mount Vernon, N. H., in Ashburnham, Mass., Hopkinton, N. H., and now (1854), retired from ministerial service to Alstead, N. H. He furnished the genealogy of the descendants of John Jennison [33], his great-grandfather. He m., Jan. 25, 1832, MARY BARKER SHANNON, b. May 3, 1810, dr. of Dr. Richard Cutts Shannon, of Saco, Me., grad. Harv. Coll. 1795, d. 1828.
- 285 1. *Edward Shannon*, b. Dec. 13, 1832.
2. *Wm. Cutts*, b. May 29, 1837, d. July 28, 1841.
3. *Mary Theresa*, b. Ap. 4, 1840; d. July 20, 1841.
- 286 4. *Helen Maria*, b. Ap. 23, 1844.
- 287 2. ORVILLA, b. Mar. 17, 1808; a farmer, of Walpole, afterwards of Danville, Vt.; m., Mar. 16, 1835, LUCY MEHITABEL, dr. of Nathan Field, of Peacham, Vt. Chil.,
- 288 1. *Caroline Rebecca*, b. June 25, 1837. 2. *Lucy Augusta*, b. May 9, 1839.
- 290 3. *Helen Eliza*, b. Nov. 25, 1840, d. 1843. 4. *Martha Ann*, b. Nov. 4, 1843.
- 292 3. WILLIAM, b. Ap. 30, 1812, d. Aug. 15, 1813.
- 292 4. ELIZA EMILY, b. Ap. 11, 1814; m., Feb. 21, 1839, CHARLES GRANDISON LIVERMORE, a woollen manufacturer, of Alstead, now (1854) travelling agent of Fairbanks and Co., for their patent scales. Chil.,
- 293 1. *Ozro Jennison*, b. Jan. 6, 1840. 2. *Adeline Eliza*, b. July 29, 1841.
- 295 3. *Charlton Field*, b. Oct. 10, 1842. 4. *Enrico Edward*, b. Ap. 13, 1845.
5. WILLIAM WALLACE, b. Jan. 23, d. June 18, 1816.
- 297 6. PHEBE AUGUSTA, b. July 20, 1820, unm.

130. 298 (VI.) PROSPER BOOTH, a cabinet-maker, of Walpole, until 1813, when he moved to West Bloomfield, N. Y.; m., Nov. 23, 1809, LUCINDA JENNISON. She d. Feb. 27, 1847. Chil.,
- 299 1. EDNA BISHOP, b. May 17, 1810; m., Ap., 1835, GEORGE STUBBERFIELD, a farmer, of West Bloomfield, N. Y., now of Gorham, O.
- 300 1. *Lucinda*, b. Feb., 1839. 2. *Ellen*, b. Sept., 1840.
- 302 3. *Samuel B.*, b. Aug., 1842 4. *Amanda*, b. Nov., 1844.
- 304 5. *Edna E. A.*, b. Nov., 1845. 6. *Reuben*, b. July, 1847.
- 306 2. AMANDA JENNISON, b. Sept. 21, 1811; m., Feb. 14, 1833, HIRAM HADLEY, a farmer, of W. Bloomfield. Chil.,
- 307 1. *Oscar F.*, b. Oct. 18, 1835. 2. *Henry H.*, b. Mar. 17, 1838.
- 309 3. *Levi J.*, b. Feb. 15, 1848.
- 310 3. SARAH E., b. Aug. 11, 1813; m., in 1841, JOSEPH HAZE, a farmer, of W. Bloomfield, N. Y.
- 311 1. *Myron*, b. Mar., 1844. 2. *Mary*, b. 1846. 3. *Arza*, b. 1849.
- 314 4. FANNY C., b. July 16, 1815; m., Sept., 1834, CHAUNCEY A. RICHARDS, of Lima, N. Y. He d. Jan., 1836, leaving one child. His wid. m. (2d), in 1839, JAMES T. BONIFACE. Chil.,
- 315 1. *Adaline* (Richards), b. Aug. 2, 1835.
- 316 2. *Mary Ann* (Boniface), b. Nov. 1, 1839; d. Mar., 1847.
- 317 3. *Georgiana Willoughby* (Boniface), b. Mar., 1854.
- 317 5. MARY A., b. July 3, 1817; m., Aug., 1832, JOSEPH LOTEE, a cooper, of Lima, N. Y. Chil.,
- 318 1. *Amos*, b. Feb. 3, 1835. 2. *Levi*, b. Feb., 1836. 3. *Ellen*, b. Mar. 24, 1847.
- 321 6. NOBLE ORR, b. May 18, 1819; a farmer, of Arkport, N. Y.; m., Oct., 1849, HENRIETTA KINNEY, of W. Bloomfield. Chil.,
- 322 1. *Henry Booth*, b. Aug., 1850. 2. *Mehitabel*, b. 1853.
-
131. 323 (VI.) LEVI JENNISON, a farmer, of Walpole. and afterwards of Langdon, N. H.; a subaltern officer in the Battle of Tippecanoe, where he was wounded; afterwards taken prisoner by the British, and sent home on parole. He m. (1st), in 1813, PRUDENCE FULLER, of Walpole. She d. July 21, 1832, and he m. (2d), Nov. 5, 1833, ELIZA ANN HOWARD, of Alstead, where he d. Aug. 10, 1850. Chil.,
- 324 1. JOHN FULLER, b. Aug. 13, 1814; M.D. Dart. Coll., 1843; a physician and farmer, of Swanzey, N. H., unm.
- 325 2. ALBERT BISHOP, b. Mar. 19, 1817; m., Sept. 9, 1841, MARY JANE HOWARD, of Alstead; moved to California, in 1851.
- 326 1. *Kathleen*, b. June 15, 1842; d. 1846. 2. *Mary Ellen*, b. July 31, 1845.
- 327 3. *Julien Albert*, b. Jan. 1, 1849; d. Jan. 28, 1851.
- 327 3. AMANDA PAMELIA, b. June 22, 1819; m., Nov. 25, 1838, LUTHER J. FLETCHER. She d. Feb. 19, 1846, leaving one child.
- 328 1. *Rosabella Amanda*, b. June 30, 1840.
- 329 4. LOUISA, b. and d. 1821.
- 329 5. MARY LOUISA, b. Ap. 9, 1829; was a teacher in N. Orleans; m., lately to — EATON.
- (By 2d wife, Eliza Ann.)
- 330 6. FREDERICK LEVI, b. Aug. 21, 1834.
- 330 7. ISABELLA ELIZA, b. July 21, 1840; d. of a casualty, June 23, 1843.
- 331 8. ELLA ELIZA, b. Feb. 5, 1845.
-
133. 332 (V.) JONATHAN JENNISON, a farmer, of Walpole, N. H.; m. RHODA ASHLEY, of Hartland, Vt. He d. Sept. 11, 1835, and his wid. Rhoda, d. Feb. 20, 1840, aged 90 years. Chil.,
- 333 1. JONATHAN, b. Aug. 30, 1775; a farmer, of Walpole; m. DANIE DUNHAM. He d. Mar. 29, 1818, and his wid. Danie, d. June 21, 1847, aged 74. Chil.,
- 334 1. *Henry*, b. Nov. 28, 1800; a farmer, of Walpole; m., Sept. 18, 1839, *Harrriet Fay*.
- 335 2. *Levi Dunham*, b. Aug. 11, 1802.
3. *Josiah*, b. 1804; d. 1806.

- 336 4. *Lurancy*, b. Ap. 27, 1807; m. *David C. Thompson*, Esq., a farmer, of Walpole, and Rep. in the State Legislature.
- 337 5. *Rhoda Ashley*, b. Dec. 23, 1808. 6. *Horace Allen*, b. Jan. 18, 1811.
7. Child, b. and d. 1812.
- 339 2. THOMAS, b. Oct. 4, 1776; a farmer, of Walpole; m. MARTHA MOORE. He d. June 24, 1823, and his wid. d. within a few years.
- 340 1. *Thomas Moore*, b. Nov. 18, 1805; m., Mar. 21, 1839, *Fanna A. Hickson*.
- 341 2. *John*, b. June 14, 1807; of Walpole; has a family.
- 342 3. *Daniel Ashley*, b. Sept. 3, 1808. 4. *Mary Holland*, b. Mar., 1810; d. 1811.
- 343 5. *Mary Holland*, b. June 5, 1813; m., Oct. 21, 1838, *John W. Lovejoy*, of Lancaster, N. H.
6. *George Charles*, b. Oct. 4, 1814.
3. NABBIE, b. Mar. 22, d. May 8, 1778.
- 345 4. MARTIN, b. June 30, 1779; m. HEPZIETH FITCH; went to the West; d. at Bowling Green, Ky., May 20, 1816, and his wid. d. Jan. 10, 1824, aged 39.
1. *Alfred*, b. Oct. 2, 1805, d.
- 346 5. RHODA, b. Sept. 3, 1781; m., June 4, 1812, Capt. PLINY BLISS, a very enterprising man; moved from Walpole to Cincinnati, in 1815, and soon after to Covington, Ky., where he d. Mar. 4, 1854, aged 78. His wife Rhoda d. of cholera, May, 1849. He established the first horse ferry-boat, and afterwards the first steam ferry-boat, between Cincinnati and Covington, and another across Tenn. River at Florence, Ala.; was some time commander of the Steamer Gen. Pike, between Maysville and Louisville. See a sketch of his life in the *Palmer (Mass.) Journal*, of Ap. 15, 1854.
- 347 6. DANIEL, b. Nov. 30, 1782; a physician, of Hartland, Vt., where he m. MARTHA ASHLEY, of Hartland. He d. many years ago. His wid. was living recently.
- 348 1. *Martha*, m. *W. S. Dickinson*, of Lebanon, N. H., both d.
- 349 7. ABIGAIL, b. Sept. 23, 1786; now of Walpole, unm.
- 350 8. CHARLES, b. Feb., 1789; a physician, of Orangeville, N. Y., where he passed most of his life, m. ELIZABETH MAHAN. He d. in Michigan, about 1846. Chil.,
1. *Charles*. 2. *Elizabeth*. 3. *Ellen*. 4. *Lucia*. 5. *Ann*. 6. *Lorenzo*. 7. *Sewell*.

- p. 310 [76.] LEVI JENNISON, after the birth of one child, moved to Shoreham, Vt., where he settled, and d. there Dec. 21, 1798. His wid., RUTH, m. BENJAMIN TOWER, and is now (1854) living, aged 85. Besides the following children, he had others, who d. in infancy.
1. ETHAN, b. in Shrewsbury, July 6, 1789, d. young.
- 352 2. SILAS HEMENWAY, b. in Shoreham, May 17, 1791. He was Rep. in Vt. Legislature, 1826, 27, 28, 29, and 30; Councillor, 1832, 33, and 34; Lt. Governor, 1835, and Governor of Vt., 1836, 37, 38, 39, and 40. He m. in 1814, MARILLA HANKS BUSH, b. in Shoreham, June 24, 1791, dr. of Eben and Sally (Cary) Bush, from Becket, Mass. He d. Sept. 30, 1849. Chil.,
- 353 1. *Lurana Sandford*, b. Jan. 3, 1815; m., in 1845, Dr. *James Little*, of Beverly, O. Chil., 1. *Silas Jennison*. 2. *Mary*.
- 354 2. *Levi*, b. Oct. 1, 1816; d. Dec. 22, 1839.
- 355 3. *Ruth*, b. May 16, 1821; m., in 1851, *Myron Orvis*. 2 chil.
- 356 4. *Sara Cary*, b. Aug. 27, 1824. 5. *Laura Louisa*, b. Ap. 21, 1829.
- 358 3. POLLY, b. May 20, 1795; m., in 1815, LEVI BIGELOW HARRINGTON, of Shoreham, b. in Worcester, Mass., Mar. 12, 1792. He d. Dec. 23, 1853. Chil.,
- 359 1. *Eliza*, b. Nov. 10, 1815. 2. *Edward A.*, b. Aug. 30, 1817.
- 361 3. *Mary*, b. Nov. 7, 1819; d. Aug. 21, 1840. 4. *Marcia*, b. June 19, 1822; d. Dec. 14, 1847.
- 362 5. *Ruth*, b. July 10, 1824; m., in 1845, *Charles H. Day*, of Ticonderoga.
6. *Sarah*, b. Dec. 19, 1827; d. Jan. 3, 1828.
- 363 7. *Almira Chapin*, b. Feb. 17, 1828; m., in 1852, *Curtis Z. Beaman*, of Mairengo, Ill.
- 364 8. *Sarah Bigelow*, b. Ap. 22, 1830. 9. *Ellen Lucretia*, b. Ap. 26, 1834.
- 366 10. *Levi*, b. Ap., d. May, 1836. 11. *Levi Franklin*, b. June 14, 1839; d. Feb. 13, 1840.

367 | 4. RUTH, b. 1797; m., in 1819, BENAJAH COOK. She d. in Shoreham, May 18, 1821, leaving dr. *Julia Ann*, b. May 19, 1820; m., in 1842, *George Jakeway*, of West Haven, Vt.; 4 chil.

p. 310. [80.] For Rev. Job Sumner, read Joseph Sumner. This William Jennison, was a son of (?) Capt. Israel Jennison [47]. [See Geneal. Reg. viii., p. 128 n.]

JOHNSON.—Solomon and Elinor Johnson, had, 1. Nathaniel. 2. Joseph (twins), b. in Sud., Feb. 3, 1639–40. 3. Mary, b. in Sud., Jan. 23, 1643–4. 4. Caleb, b. in Sud., Feb. 1, 1645–6. Solomon Johnson (then aged 34) was appointed herdsman of Wat., Mar. 31, 1651, to have charge of the cow-pen, near Sudbury line, and he continued there until 1660. His son Caleb was accidentally shot May 4, 1654, near his house, "in the Liberties of Watertown." Jan. 19, 1663, the selectmen of Wat., ordered that Solomon and John Johnson, of Marlboro, be sued for balance of ministry rate. John Johnson was aged 57, in Mar., 1685–6.

p. 311. **JONES.**—Lewis Jones, had dr. Phebe, b. in Rox., 1645; d. 1650. He probably moved to Wat. about this date, just before the birth of his son Shubael. Ap. 23, 1679, Lewis Jones, of Wat., planter, for 12 cords of wood, sold to Justinian Holden, about 3 acres, bounded with the farmland of Holden, "and the Great Fresh Pond surrounding the same." Wit. John Eames, and John Collar. 1664, Edward Wilson, constable, charges for carrying home Samuel Jones, of Wat., from Boston. Perhaps for Samuel, should be read Shubael, who was non-comp. Dec. 29, 1684, Josiah Jones, ex'r. of his father's Will; John Stone, overseer of the same; Simon Stone, and John Stone, guardians of "Suball Jones," all of Wat., sold to John Coolidge, 10 acres in Wat., bounded S. by country road; W. by Dea. Bright; N. by Joseph Mason; E. by highway. Wit. John Chadwick, and John Nevinson.

[1.] Capt. Josiah Jones was selectman of Wat., 1685, 86, 87, 90, 1702, 9.

[5.] Nathaniel Jones was a Captain; selectman of Worcester; 1722, and 23, and Rep. 1727.

[10.] Strike out all after 1715. This was not the Jonas Jones, who m. A. H., and settled in Shrewsbury. [See Hist. of N. Ipswich, p. 393.]

p. 312. [26.] Dec. 29, 1699, Josiah Jones [1] and wife Lydia, executed a gift deed to son Josiah Jones, of 50 acres in Wat. [Farms]; also, 10 A., and some other lands.

[32.] [See Bond, 1., Part II., p. 686.] Mar. 1, 1702–3, Josiah Jones [1] and wife Lydia, sold to son Samuel Jones, weaver, 17 acres, bounded N. and W. by J. J.; S. by Nathaniel Bright; E. by S. J. Also, at the same time, 150 acres, bounded N. and S. by squadron lines; W. by Jonathan Bullard; E. by — Saltonstall.

[47.] Abigail, m., in Teinpleton, Mar. 8, 1778, John Locke. [Locke Fam., p. 53.]

p. 313. [62.] The Will of John Jones, of Weston, dated Feb. 11, 1763, lodged June 4, 1774, mentions son John, to whom he had already given 320 A. in Princeton; son Benjamin, to whom he had given 240 A. in Oakham; son Ezra, to whom he had given 320 A. in Rutland, and son Abraham.

[63.] Col. John Jones, was a celebrated land surveyor; was, in 1760, chosen Proprietor's Clerk, of Natick, and was a deacon of the 2d church (Mr. Badger's) in Natick. He lived on a promontory, or peninsula, in the north part of Dover, surrounded on the N. and W. and E. sides by Charles River. The estate, in 1830, belonged to Mr. Loring. He was a civil magistrate under the Colonial, and afterwards under the State government. He d. Feb. 2, 1802, aged 85 yrs. 3 m. 2 d. [See Bigelow's Hist. of Natick.]

p. 314. [102.] Abigail, wid. of Col. E. Williams, d. Dec. 4, 1784, aged 90.

[105.] Mr. Sergeant d. July 27, 1749, aged 39. Gen. Joseph Dwight, son of Henry Dwight, of Hatfield, was born Oct. 16, 1702; grad. Harv. Coll., 1722; settled in Brookfield, and was admitted to practice law in Worcester County; thence he removed to Great Barrington, where he d. June 9, 1765. He was Rep. of Brookfield, 1748, 49, 51, and Speaker, 1748 and 49, and was a member of the Council. He was Brig. General in the expedition against Louisburg, in 1745. He was afterwards a Judge of the court in Berkshire County. [Hist. of Brookfield, pp. 46 and 50.]

[108.] John Sergeant, Jr., d. at New Stockbridge, N. Y., Sept. 8, 1824, aged 77.

[109.] For Mary Dwight, read Pamela Dwight. She d. Sept. 20, 1807, aged 47; and Hon. T. Sedgwick d. in Boston, Jan. 24, 1813.

p. 315. [110.] Henry Dwight d. Sept. 15, 1804, aged 47.

- [111.] Josiah Jones, d. May 6, 1759, aged 38.
- [112.] Judith, m., Sept. 17, 1761, Rev. E. T., who d. Feb. 12, 1773, and she d. in Stockbridge, Ap. 5, 1801. Her son Enoch d. unm.
- [114.] Mrs. Sophia (Partridge) Jones, d. Oct. 25, 1830.
- [122.] For a copious and minute record of the descendants of William and Sarah (Locke) Jones, see Locke Family, p. 34, &c.
- [131.] Col. Elisha Jones was Rep. of Weston, 1754, 56, 57, 58, 60, 61, 62, 63, 73, 74. He was a Royalist, and several of his descendants imbibed his principles.
- p. 316. [153.] ISRAEL JONES, Jr., of North Adams, m., in 1802, PHILENA FOOTE, b. Sept. 22, 1779, dr. of Obed and Mary (Todd) Foote, first of Plymouth, Conn., afterwards of Gill, Mass. [See Foote Genealogy, pp. 192 and 122.] Chil.,
1. *Alathea*, b. Aug. 3, 1803; m., May 21, 1833, *Alexander Morris*, of C. W.
 2. *Israel Foote*, b. July 5, 1805, in Burlington, N. Y.; a lawyer; m. in 1833; d. in Prescott, C. W., Ap. 4, 1844, leaving 6 children.
 3. *Charles*, b. Aug. 1, 1809, in Yonge, C. W.; is a Presbyterian minister; m., and resides in Owego, N. Y.
- p. 317. [177.] See Locke Family, p. 307.
- [179.] (?) Samuel Jones and Esther Merriam, both of Lex., m., Dec. 4, 1760.
- [189.] The estate of LEMUEL JONES divided, in 1783, to *James, Amos, Lemuel, Enoch, Anna, Daniel, Sarah*, and *Ruth*. Leonard and Garfield probably d. young.
- p. 318. [221.] Sparks, (?) Parke. Stephen Jones d. Ap. 8, 1840, and his wife d. Oct. 9, 1828, aged 65.
- p. 319. [252.] For Kingsbury, read Kingsley.
- p. 320. [265.] For Feb., read May. [268.] For Jan. 19, read 7; and for Dec. 1, read Jan. 12.
- [270.] Dea. Josiah Jones, d. Feb. 10, 1834.
- p. 321. [283.] Dr. H. Jones m., Mar. 22, 1800, E. B.
- [†297.] For July 18, read July 9.

JOURDEN.—Alexander Jourden, a Scotch prisoner, brought from England, by John Cloise, in Capt. Allen's ship, kept and ill-used by Cloise and wife, and then sold for £17; presented complaint to the County Court in 1653 [Court Files].

- p. 323. **KELLY.**—Mary, wid. of John Kelly, adm. f. c. Wat., Ap. 22, 1750.
-

KEMBALL.—Inventory of Henry Kemball, dated July 22, 1648. Admin. on estate of wid. Susanna Loe, granted Oct. 7, 1684, to her children, John Kemball, and wid. Straite. She d. Aug. 19, 1684, and her Inventory, by John Biscoe, and John Warner, presented to court, Oct. 7, 1684. Farm, 80 acres, £127; 7 A. dividend land, £9 9s.; 6 A. in lieu of township, £3 3s.; 2 A. plowland, £5 5s. At court, Ap., 1651, "Thomas Straite acknowledged that he had received the portion of Elizabeth, his wife, from her father's estate." Also, John Randall had his wife Susanna's share. There was a John Loo, of Boston, in 1649. Did he marry the widow of Henry Kemball? In the settlement of the estate of John Winter, in 1691, there is mentioned land bought of William Loe.

[4.] Sept. 6, 1687, and again in 1688, John Kemball was allowed by court to be "gager of casks," and sealer of weights and measures.

[8.] John Kemball, was a cooper.

[11.] John Kemball was selectman, 1765, 66, 67, 68, 69; and tax-collector, 1767.

- p. 325. **KENDALL.**—In last line, for Woodward, 36–42, read 211–214. July 9, 1711, Joshua Kendall, of Wat., weaver, b. in Woburn, Mar. 14, 1689 (son of Samuel and Rebecca (Mixer), of Woburn [Mixer, 6.]), bought a house and several parcels of land, estate of Martin Townsend, d. q. v.
-

KETTLE.—John Kettle m., in Sud., Sarah Goodnow, b. Mar. 17, 1642, dr. of Edmund and Hannah G.

KIDDER.—Thomas Kidur, of Wat., adm. freeman Ap. 18, 1690.

- p. 326. **KING.**—9th line, for 1646, read 1644. This "young, resolute, and confident" Thomas King, appears to have been the pioneer in the settlement of Rutland [then called Nashaway]. From an excursion thither, with Sholan, an Indian chief, he returned and induced the hardy and adventurous John Prescott and others, to go and commence a settlement there. He and Symonds, built a trading-house; but he died in Watertown, before he had moved his family thither. His inventory renders it very probable that he was a trader in Watertown. [See Willard's Centennial Address, at Lancaster, and Geneal. Reg. viii., p. 56.] Mary King, a member of the 2d church, in Boston (name of her husband not given), had eight chil. bap. there, the 6th of whom, Richard, was bap. Oct. 18, 1711. Was this the Richard King who settled in Watertown, as early as 1740, and afterwards moved to Scarborough?
- Thomas
Rice*
- The Will of Richard King, of Littleton, dated Feb. 25, proved Mar. 26, 1771, mentions wife Elizabeth; sons Roger, Richard, and Samuel; dr. Elizabeth, wife of Josiah Parkhurst; dr. Mary, wife of Oliver Corey; dr. Abigail, wife of Asa Lawrence [J. Lawrence, 276, Part II.]; and son James.
- Sept., 1739, caution against (settlement of) Rachel King, from Boston, staying at wid. Barnard's. Feb. 10, 1740, Richard King petitioned the selectmen of Wat., for permission to erect a sawpit or scaffold, at the S. end of the bridge; not granted.

- p. 327. **KINGSBURY.**—John Kingsbury was deputy of Dedham, in 1647. See Geneal. Reg. vii., p. 168.

KNAPP.—[1.] Mar. 1, 1630-1, Nicholas Knapp was fined by the court five pounds, for taking upon him to cure the scurvy by a water of no value, which he sold at a very dear rate, to be imprisoned till he pay his fine, or give security for it, or else be whipped, and be liable to any man's action of whom he had received money for said water. [Col. Records.]

[1-2.] Timothy Knapp, deputy of Rye, Conn., Oct., 1670.

[1-3.] Joshua Knapp, of Greenwich, Conn., adm. freeman, 1669.

[1-4.] Caleb Knapp, of Stamford, Conn., adm. freeman, 1669.

Moses Knapp, of Greenwich, Conn., adm. freeman, May, 1670.

- p. 327. [2.] The Will of William Knapp, mentions sons, William, John, and James; and drs. Elizabeth, Mary, Anne, and Judith. Wit. Richard Beers, Richard Bloiss, Nathaniel Salisbury. Mid. Deeds, vol. ii., p. 201-3, says he d. intestate, and his estate divided by order of the court. Perhaps the Will was set aside because made before his last marriage. Oct. 15, 1658, admin. on the estate was granted to Ephraim Child, Richard Beers, and Priscilla Knapp. The next April, she was released from the administration. Dec., 1658, the constable of Wat. was ordered by the court to deliver wid. Knapp her chest and other things, which John Knapp has detained from her by attachment. Dec. 16, 1662, Ephraim Child and Serjt. Beers were discharged from admin. of Wm. Knapp, and John Coolidge and Henry Bright appointed in their place.
- [3.] Wid. Margaret Knapp a town charge in 1681; d. a pauper, previous to Jan., 1702-3.
- p. 328. [4.] For adm. freeman, read, took oath of fidelity.
- [5.] Joshua Knapp [? son of John [5.] and Sarah], m. (1st) Sarah —, and had, 1. Samuel, b. in Rox., June 26, 1715, "not an inhabitant" of Rox. June 12, 1716, Joshua Knapp and family, from Rox., cautioned against settlement in Camb. Joshua Knapp m., in Newton, 1727, Elizabeth, dr. of John and Bethia Prentice.
- [7.] For adm. freeman, read, took oath of fidelity. James Knapp was one of the original proprietors of Groton; was a Sergeant; was one of the four men to whom a grant was made to encourage the building a mill in Groton. [See Tarball, 1.] Elizabeth Knapp, of Groton (wife of James), was one of the bewitched persons mentioned by Cotton Mather. [See Butler, p. 254.]
- [11.] This was probably the Elizabeth Knapp, who lived in the family of Samuel Cole, of Boston, in Nov., 1657. She probably m. John Buttery, and went with him to England. [See Buttery, p. 733.]

KNIGHT.—Joseph Knight (supposed to be a son of John, of Wat.), soon after the sale of his house, moved to Woburn, and there, by wife Hannah, had numerous children, one of whom, Dinah, July 4, 1660, m. John Morse, Jr. [See Morse [1.], in Part II.] Joseph Knight, Sen., d., in Woburn, Aug. 13, 1687, and his wid. Hannah, d. Jan 13, 1694-5.

- p. 329. **LAMSON.**—John Lamson, m. (2d), in Charlestown, Dec. 22, 1720, Sarah Rand (not Abigail).
 [4-1-2.] Rev. Alvan Lamson, ordained in Dedham, Oct. 29, 1818; m., July 11, 1725, Frances Fidelia Ward, dr. of Hon. Artemas Ward. [Ward Fam., pp. 89, and 149.]
 4 chil.,
 [7-3-2.] Rev. Joseph Bennet, d. (suicide) 1851.

p. 331. **GEORGE LAWRENCE.**—[1.] Will of GEORGE LAWRENCE, dated 1707, mentions wife ELIZABETH, two youngest chil., *Joseph and Rachel*; sons *George, Benjamin, and Daniel*; dr. *Mercy Baker*, living at Yarmouth; dr. *Grace Edes*, at Charlestown; dr. *Elizabeth Whitney*, at Stow; dr. *Hannah Suxtel*, at Groton; dr. *Judith Sterns*, of Camb. Farms; dr. *Mary Flagg*; dr. *Sarah Rider*; dr. *Martha Dix*; gr. dr. *Mary Earl*. Sons Daniel and George appointed administrators, at the request of the widow. Inventory dated Ap. 5, 1709.

For immediately assigned, read, in 1709 assigned, &c.

[4.] Strike out, (?).

- [6.] BENJAMIN LAWRENCE, a waterman, of Charlestown, m. (1st) in Boston, July 4, 1689, MARY CLOUGH. He m. (2d), Feb. 3, 1695, ANNA, wid. of Benjamin Phillips, of Charlestown. She d. Jan. 11, 1715-16, aged 37. He m. (3d) Nov. 18, 1716, ANNA, wid. of Nathaniel Adams, of Charlestown, and dr. of Nathaniel Coolidge, of Wat. [Coolidge 46, Part II.] She d. Dec. 28, 1718, aged 47. He m. (4th) July 9, 1719, ELIZABETH BENNETT. She d. Nov. 26, 1738, aged 75. His Will, dated Sept. 7, 1733, mentions wife Elizabeth; gr. dr. Mary Lawrence, of Boston, in her (?) 12th year [dr. of son John]; chil. of dr. Abigail "Parks," of Boston, viz., John, Elizabeth, and Ann; dr. Elizabeth Colby, of Newbury; dr. Mary Stevens, of Sheepscoot, York Co.

Benja Lawrence

1. JOHN, bap. Nov. 22, 1696; a chairmaker or joiner; m. (pub. in Boston, May 28), 1724, ANNA DINSDALE. She probably d. in childbed, leaving dr. Mary, mentioned in the grandfather's will. He m. (2d), Oct. 1 (pub. in Boston, Aug. 23), 1725, DOROTHY STAFFORD. His Will, dated July 5, 1732, gave his estate to his wife Dorothy. His wid. Dorothy m. Thomas Wharton. Sept. 12, 1737, Thomas Wharton, housewright, was appointed guardian of "his daughter-in-law [stepdaughter], Mary Lawrence," dr. of John, late of Charlestown, joiner, having land in Watertown.
2. ABIGAIL, b. Oct. 30, 1698; m. (pub. in Boston, Feb. 2), 1715, STEPHEN "PERK," of Boston. She d. 1733, leaving 3 chil., viz., 1. *John*. 2. *Elizabeth*. 3. *Ann*.
3. WILLIAM, bap. July 14, 1700, d. soon.
4. ELIZABETH (? twin), bap. July 14, 1700, d. soon.
5. ELIZABETH, bap. Oct. 4, 1702; m., Dec. 22, 1720, AMBROSE COLBY, of Newbury. He was adm. f. c. Charlestown, Mar. 1, 1718-19.
6. BENJAMIN, bap. Sept. 10, 1704; d. before his father.
7. MARY, bap. Feb. 23, 1706-7; m. (? Thomas) STEVENS, of Sheepscoot, of York Co.

- 1 [7.] DANIEL LAWRENCE, a tailor (? painter) of Charlestown; m. (1st), in Charlestown, June 19, 1689, SARAH COUNTS. [In 1715, Hannah, wid. of Samuel Counce, executed a deed in favor of Samuel Lawrence.] He m. (2d), Nov. 1695, HANNAH MASON. She d. Aug. 27, 1721, aged 56. He m. (3d), Aug. 23, 1722, MAUD RUSSELL, bap. June 25, 1676, dr. of James and Mabel (Haynes) Russell, and gr. dr. of Hon. Richard and Maud Russell, all of Charlestown. He d. Oct. 20, 1743, aged 78. Inventory dated Dec. 12, 1743, £217 13s. 6d. Admin. granted to son Daniel.

Daniel Lawrence

The Will of wid. Maud Lawrence, "far advanced in life," dated Dec. 22, 1747, proved May 14, 1748, mentions her nephew, Thomas Jenner; niece Abigail Stevens; sister Mabel Jenner; brother Daniel Russell; sister Mary Miller; cousins Ezekiel, David, and Sarah Cheever; Elizabeth Hendley and husband; nephews, Chambers Russell, and wife; James Russell, and wife; Richard Russell, and wife; Daniel Russell; niece Abigail Russell; niece Rebecca Wyer, and husband; cousin

John Stevens, and wife; cousins Abigail and Grace Stevens; Mabel Bird, and husband; cousins David, Samuel, and Joanna Jenner; son-in-law [step-son] Daniel Lawrence, and wife; dr.-in-law [stepdaughter] Hannah Calder; cousin Elizabeth Stanley.

- 2 1. DANIEL, bap. Aug. 9, 1696; m., Dec. 17, 1722, MARGARET ALLEY.
 3 1. *Daniel*, bap. Oct. 27, 1723; a painter, of Charlestown; m., Ap. 17, 1746, *Sarah Grant* [15-2]. He d. Aug. 23, 1750, aged 26. Wid. Sarah returned admin'x account, 1757.
 4 1. Samuel, bap. Jan. 18, 1746-7; drowned.
 5 2. Sarah, bap. Ap. 2, 1749. 3. Samuel, bap. May 20, 1753.
 6 2. *Hannah*, bap. Nov. 21, 1724; m., Dec. 20, 1744, *Walter Hunter*, a mariner, of Charlestown. Admin. on his estate granted June 20, 1748, to wid. Hannah, Thomas Maudlin, and Daniel Lawrence, Jr.
 7 1. Margaret, bap. Ap. 13, 1746.
 8 3. *Samuel*, bap. Jan. 15, 1726.
 9 4. *Margaret*, bap. Sept. 23, 1728.
 10 5. *Margaret*, bap. Oct. 7, 1733.
 11 2. SAMUEL, bap. in 2d Church, Boston, May 22, 1698, mentioned among the heirs of his father. May 25, 1741, Daniel Lawrence, aged 19, son of Samuel Lawrence, of the Island of St. Christopher, chose his grandfather, Daniel Lawrence, his guardian. Sarah, wid. of Samuel Lawrence, of Charlestown, signed a deed 1759. Copy of a paper, dated Charlestown, Nov. 26, 1743: "This may certify, that I am willing that my uncle, Daniel Lawrence, should take administration of my grandfather Lawrence's estate. (signed) DANIEL LAWRENCE."
 12 3. HANNAH, bap. Feb. 26, 1699-1700 (pub. in Boston, Feb. 3); m. Mar. 3, 1719-20, Dr. ROBERT CALDER, of Boston, afterwards of Charlestown, in the publication said to be "of Great Britain." She d. Nov. 25, 1758, aged 59 [gravestone].
 13 1. *Hannah*, bap. in Charlestown, Nov. 11, 1722.
 14 2. *Barbara*, m. *Benjamin Fessenden* [See Fessenden, p. 757].
 3. *Rebecca*, b. Aug. 8, 1742 4. *William*. 5. *George*. 6. *Lydia*.
 15 7. *Elizabeth*, chil. of Hannah, wid. of Robert Calder, bap. June 15, 1746. William and George d. young.
 4. SARAH, bap. Mar. 29, 1702, d. soon.
 16 5. LYDIA, bap. Jan. 30, 1703-4; m. (1st), Aug. 14, 1722, WILLIAM AUSTIN. He d. Oct. 28, 1730, æt. 32, and she m. (2d), Oct. 21, 1736, JOHN E. PITCHER. She d. Jan. 13, 1741, æt. 37 [gravestone].
 17 6. SARAH, bap. Feb. 3, 1705-6; d. before her father, s. p.

[10.] For Dec. 4, read Dec. 11. [See Court File, 1681.] John Earl, of Boston, m. in Charlestown, Oct. 27, 1719, Mary Boylston [Boylston 7, Part II.]

[12.] Grace Lawrence m. John Edes, of Charlestown. 11 chil.

[13.] Joseph Lawrence, locksmith, of Charlestown, and wife Hannah, signed a deed in 1714, and another in 1717, in favor of his brother George.

[15.] Patience, d. young; not mentioned in her father's Will.

[15.] Mercy, perhaps the eldest child; mentioned in her father's Will; m. — BAKER, of Yarmouth.

[25.] Wid. Mary, admin'x, presented her account 1774.

The Will of Elijah Lawrence, dated Nov. 29, 1784, proved May 17, 1805, mentions brother George, and his wife Esther, and chil. Jonas, Elijah, and Josiah, and Eunice Sanderson.

[26.] 6½, Jonas, b. about 1740.

p. 332. [36.] Admin. granted to Mary, wid. of Samuel, May 7, 1764. Inventory, £49 11s. 5d.

[44-5.] Eunice, m., Mar. 25, 1802, Samuel Sanderson [151].

[44-8.] Josiah (son of George and Esther), a baker, of Savannah, in 1815, signed a discharge of his guardian.

JOHN LAWRENCE.

(I.) JOHN LAWRENCE,* settled in Watertown, probably in 1635, as his eldest child was born there, Mar. 14, 1635-6. His name is on the earliest list of proprietors extant, and he was adm. freeman Ap. 17, 1637. The date of his arrival in America has not been ascertained, nor is it known whether he was married before or after his arrival. Nothing has yet been ascertained from American records or archives, with respect to his parentage or ancestry. It has been supposed that he was the John Lawrence† of great St. Albans, Hertfordshire, who embarked in the Planter, for New England, in 1635, then aged 17 years. This is evidently a mistake, as the passenger in the Planter was only 19 years old when John Lawrence, of Watertown, was admitted freeman.

By his first wife, ELIZABETH, he had 12 children, all born between his settlement in Watertown, and his removal to Groton, whither he moved in the autumn of 1662. His wife, Elizabeth d. there the next summer, Aug. 29, 1663, and he m. (2d), Nov. 2, 1664, SUSANNA BATCHELDER, dr. of William Batchelder, of Charlestown. He d. July 11, 1667, and his wid. Susanna d. July 8, 1668. His Will, dated Ap. 24, proved Oct. 1, 1667, appoints his wife, and sons Nathaniel and Joseph, ex'rs; mentions sons Enoch, Samuel, Isaac, Jonathan, and Zechariah; of the three at home. Elizabeth, "to live with Mr. Ensigne-Buss, of Concord, till of age; the other two, Enoch and Zechariah, be trust to Samuel Willard and William Lakin, till of age." To his dr. Mary he gave only half a portion with the rest, "to teach her a remembrance of her disobedience and unfaithfulness to me in my distress." [She had married two days before the decease of her mother.] Inventory, £278 0s. 4d. House and 10 acres of land, from the street to the hill, taking an equal breadth, appraised at £60. The Will of his wid. Susanna, dated at Charlestown, July, proved Dec. 16, 1668, mentions her two daughters, Abigail and Susanna; her father and mother Batchelder; two sisters, Rachel Atwood and Abigail Asting; her father Batchelder, and brother Atwood, of Malden, ex'rs.



[Signature to his Will.]

The date of his removal to Groton is determined with sufficient precision by the following facts. Oct. 23, 1662, he sold land in Watertown to John Barnard. Oct. 27, 1662, he sold another lot to William Page, and on the same day another lot to Joseph Underwood, and on the same day he sold to John Biscoe his homestead in Watertown, a dwelling-house, &c., and about thirteen acres, "being the now mansion-house of said John Lawrence," bounded on the E. by the highway; N. by Timothy Hawkins and John Hammond; W. by the meadow of said Biscoe; S. by land of John Flemming, deceased; wid. Dix, and her sonne; wid. Bartlett, and said Biscoe. In Dec. 1662, "meet men were found amongst the inhabitants [of Groton], when Dea. James Parker, John Lawrence, William Martin, Richard Blood, and James Fiske, were chosen selectmen" [Butler, p. 17]. His early admission as freeman, and this election to the first board of selectmen of Groton, show that he was well known, and of good repute. According to the list of possessions in Watertown in 1642, he then owned 7 lots, amounting to 154½ acres. In legal instruments he was designated a carpenter, although, from the amount of his land, it might be presumed that he was chiefly devoted to agriculture. The birth

* In compiling the following genealogy of the descendants of John Lawrence, we with pleasure acknowledge our obligations, in the first place, to Butler's very valuable History of Groton, so often referred to in the course of this work; in the next place, to the Genealogy of Isaac Lawrence (366), by Mr. F. S. Pease, published in Albany in 1833; and lastly, to "the Memoir of the Family of John Lawrence," by Rev. John Lawrence, printed in Boston in 1847, but not published. To the latter we are indebted for much information respecting the later generations. A gentleman has lately succeeded, as we are told, in discovering the pedigree of the Lawrence families in England, and tracing it back to a remote period. This pedigree has not yet been received in this country. Perhaps it may be forwarded in such time as to find a place in our Appendix.

† The following family, from Great St. Albans, Hertfordshire, embarked in the Planter, Nic. Trarice, Master, Ap. 2, 1635.

JOHN TUTTILL, mercer, aged 39; JOAN TUTTILL, aged 42; JOHN LAWRENCE, aged 17; WILLIAM LAWRENCE, aged 12; MARIA LAWRENCE, aged 9; ABIGAIL TUTTILL, aged 6; SYMON TUTTILL, aged 4; SARA TUTTILL, aged 2; JOHN TUTTILL, aged 1 year.

1633-4. Mrs. Joanna Tuttle was wif of her husband John Tuttle, then living in Ireland. He d. at Carrickfergus, Ireland, Dec. 30, 1656. It appears by the court files of Essex, 1659, that Joanna Tuttle had a son George Giddings; son John Lawrence; sons John and Simon Tuttle. Also, that there was a John Tuttle, then aged 33, nephew of her husband. As no son William Lawrence is mentioned in this document, we may infer that he was not then living. It is here evident that this Joanna m. (1st). — Lawrence, and afterwards John Tuttle. The numerous and respectable Lawrence families of Long Island and New York, are said to trace their lineage to these emigrants, John and William, from Great St. Albans.

There was a Henry Lawrence of Charlestown as early as 1636. In the first division of land on Mistick side, Ap. 20, 1638, he received five acres. July 22, 1648, wid. Christian Lawrence (supposed to be the wid. of Henry) and her son John, sold land at Fort Point. The age of this son John has not been ascertained. Wid. Christian Lawrence d. Mar. 3, 1647-8. Oct. 8, 1648, Nicholas Lawrence, of Charlestown, sold land at Fort Point to Nicholas Shapley.

of his dr. Elizabeth is recorded in Boston, and as no births of his family are recorded in Wat., from 1649 until 1659, perhaps he resided in Boston several years, in the exercise of his trade. Chil.,

15. 2 1. JOHN, b. Mar. 14, 1735-6. He is not mentioned in his father's Will, and it might therefore be concluded that he was deceased, and without issue. But it is to be observed, that he does not mention his son Peleg, nor his drs. Abigail and Susanna, who are known to have been then living. We shall assume that he was then living, until there is some evidence to disprove it, and that he had a family.
2. JONATHAN, buried Ap. 6, 1648.
23. 3 3. NATHANIEL, b. Oct. 15, 1639; an executor of his father's Will, adm. freeman May 15, 1672.
4. JOSEPH, b. Mar., d. May, 1642.
- 4 5. JOSEPH, b. May 30, 1643; an ex'r of his father's Will; adm. freeman May 15, 1672; m., 1670-1 (?) REBECCA —. He was probably the Joseph Lawrence who, by wife Rebecca, had dr. Rebecca, bap. in the 1st Church of Boston, Feb. 1, 1679-80, and who d. Nov. 14, 1685. It is conjectured that the persons making the following Will were his wife and daughter. The Will of Rebecca Lawrence (? of Boston), dated July 18, proved Dec. 12, 1726, gives her estate to her mother, Rebecca. The Will of wid. Rebecca Lawrence, dated Sept. 27, proved Oct. 11, 1731, bequeathed her estate to her sisters, Margaret Davis, Ruth Royce, Maria Frost, Hanna Davis; nephew Wm. Whitcomb, and niece Huldah Archibel. [Joseph Lawrence was witness to Broomfield's deed, Newbury, 1677.]
- † 6. MARY, b. July 16, 1645; d. 1686-7; m., Aug. 25, 1663, INEGO POTTER, of Charlestown. Chil. 1. John. 2. Richard. 3. Inego, bap. in Charlestown, Ap. 24, 1683. 4. child, bap. July 9, 1682.
32. 6 7. PELEG, b. Jan. 10, 1646-7.
41. 7 8. ENOCH, b. Mar. 5, 1648-9.
- 8 9. SAMUEL, mentioned in his father's Will; probably the one who m., Sept. 14, 1682, REBECCA LUEN, of Charlestown. It is conjectured that he moved to Connecticut.
- 9 10. ISAAC, mentioned in his father's Will; m., Ap. 19, 1682, ABIGAIL BELLOWES, b. in Concord, May 6, 1661, dr. of John and Mary (Wood) Bellows [see "Bellows Family, of Walpole, N. H."]. Isaac Lawrence, and wife Abigail, of Norwich, Conn., heirs of their uncle, Dea. Isaac Woods, of Marlboro, executed a deed, Feb. 26, 1718-19.]
- 10 11. ELIZABETH, b. in Boston, May 9, 1655.
- 11 12. JONATHAN, mentioned in his father's Will. He d. 1725. Perhaps he was the one who m., in Camb., Nov. 5, 1677, REBECCA RUTTER. If so, they d. s. p., for Jonathan, of Groton, in his Will, does not mention wife or children; but he gave to the town of Groton £100; to the Church of Christ, in Groton, £40, to be laid out for the procuring some silver vessel or vessels for the church's use, as they shall order. Also, £20, the income to be annually paid or accounted for to the settled or ordained minister.
- 12 13. ZECHARIAH, b. in Wat., Mar. 9, 1658-9. He was probably the Zechariah Lawrence, of Boston, mariner, master of the "Success," against whom a suit for wages was brought in 1691.
(By 2d wife, Susanna.)
- 13 14. ABIGAIL, b. in Groton, Jan. 9, 1665-6.
- 14 15. SUSANNA, b. July 3, 1667, eight days before the d. of her father.
-
2. 15 (II.) JOHN LAWRENCE, m., about 1657, SUSANNA —, and lived probably in Charlestown. "He is named on the list of those who paid county rate." His Inventory, amounting to £160 8s., was taken June 17, 1670, by John Pentecost and John Burrage. It included 1 shallop, £40, house and wharf, £90. His wid. Susanna, m. in Charlestown, Aug. 15, 1676, Thomas Tarball, Sen. [see Tarball]. He d. previous to 1680-1, for wid. Susanna Tarball was adm. to Charlestown Church, Mar. 6, 1680-1; Hannah and Abigail Lawrence, drs. of wid. Tarball, bap. in Charlestown, Ap. 24, 1681; John, youngest son of wid. Tarball, bap. Mar. 3, 1681-2. In Court, in 1681, the age of Hannah Lawrence was stated to be 20 yrs., and that of Abigail Lawrence to be 19 yrs. [Perhaps it will yet be discovered that this John Lawrence was a son of Henry and Christian Lawrence, of Charlestown.]

- 16 1. HANNAH, b. Feb. 22, 1658-9, bap. in Charlestown, Ap 24, 1681; m., Sept. 21, 1682, JAMES CAPEN. His Will, dated Jan. 1, 1717-18, mentions wife Hannah, son James, and dr. Hannah Andrews. [Hannah Capen, of Charlestown, and John Fenno, of Boston, pub. Oct. 9, 1736.] Chil.,
- 17 1. James, b. July 11, 1683.
- 18 2. Hannah, b. Oct. 13, 1686, m. — Andrews.
- 19 2. ABIGAIL, bap. Ap. 24, 1681, then aged 19 yrs.; m. (1st), Sept. 1, 1684, EDWARD WYER. She m. (2d), Dec. 25, 1689, NICHOLAS LAWRENCE, Jr.,* a mariner, of Charlestown, b. in 1661. In 1691, he was master of "the kech, Salisbury." He and his wife were adm. f. c., Charlestown, Feb. 15, 1707-8. He d. Feb. 28, 1710-11, aged 49 yrs. 8 mos. His Will, dated Feb. 23, proved Mar. 19, 1710-11, mentions wife Abigail, and his only dr., Abigail, b. Aug. 26, 1693, d. Nov. 5, 1713, aged 20 yrs., 2 mos., 9 d. His wid. m. (3d) Edward Clifford, a gunsmith, of Charlestown. She d. prior to Ap. 14, 1729.
- 20 3. SARAH, d. in Charlestown, 1724, unm. There is a document in the Probate Office, dated Aug. 11, 1729, in which are mentioned Hannah Capen, and Sarah Lawrence, spinster, sisters of Abigail, wid. of Nicholas Lawrence, and afterwards wife of Edward Clifford, gunsmith.
- 21 4. DAVID. [When John Lawrence was bap., he was designated as the *youngest son* of wid. Tarball, implying that an elder brother was living, and he is supposed to have been this David.] He m. in Charlestown, Feb. 3, 1700-1, SARAH, dr. of Samuel and Hannah Whittemore. July 22, 1702, Samuel Whittemore, and wife Hannah, executed a deed in favor of son David Lawrence, and his wife Sarah. The Will of Sarah Lawrence, of Camb., dated _____, mentions her son, Uriah; Jonathan, son of her daughter, Elizabeth Dickson; gr. dr. Sarah Champney; chil. of son Jonathan Lawrence d.; drs. Sarah Phillips and Catherine Champney; brother Samuel Whittemore, Exr. Wit., Samuel Whittemore, Margaret Whittemore, and Margaret Whittemore, Jr. Richard Champney and Catherine Lawrence, pub. in Boston, Mar. 1736. William Lawrence, of Providence, R. I., gave power of att'y to Samuel Whittemore, concerning right in the estate of David and Sarah Lawrence. Samuel Whittemore and wife Margaret executed a deed to wid. Sarah Lawrence in 1735. Wit., Samuel Whittemore, Jr.
- 22 5. JOHN, "youngest son," of wid. Susanna Tarball, was baptized in Charlestown, Mar. 3, 1681-2, when he must have been at least 12 yrs. old. Nov. 25, 1700, admn. was granted to Sarah Lawrence, of Charlestown, spinster, and James Capen, upon the estate of her brother, John Lawrence, of Charlestown, mariner. He probably d. unm.
-
3. 23 (II.) Dea. NATHANIEL LAWRENCE, of Groton, m., in Sud., Mar. 13, 1660-1, SARAH MORSE, b. Sept. 16, 1643, dr. of John and Hannah (Phillips) Morse, of Dedham. [See Memorial of Morse, p. 40.] She d. in Groton, in 1684, and he m. (2d) HANNAH (Anna) —. She d. after 1701, for Nathaniel L., and wife Hannah, of Groton, signed a deed Jan. 14, 1701. He was adm. freeman, May 15, 1672; was early chosen a deacon; was a Rep. of Groton, and much employed in town business. In advanced life he moved to Charlestown Farms, where he d. Ap. 14, 1724, aged 85. His Will, dated Aug. 4, 1718, proved May 8, 1724, mentions son Nathaniel, to whom he gave land in Groton; son John; drs. Hannah Houlden, and Mary Wheeler; son Samuel Page; dr. Elizabeth Harris; dr. Deborah, and grandson Lawrence. Inventory, £714 18s. 6d.
- 24 1. NATHANIEL, b. in Sud., Ap. 4, 1661. There is much obscurity, and much left to conjecture about his family. He is supposed to be the Nathaniel Lawrence,

* THOMAS LAWRENCE was proprietor of Hingham in 1687. The next year he became "lawful owner of 400 acres of land, bounded westward with cedar swamp, and eastward with the land of Thomas Clap, &c." He m. ELIZABETH, sister of James Bates, of Dorchester. He d. in Hingham, Nov. 5, 1666, and his wid. soon after moved with her family to Dorchester. Chil.,

1. NICHOLAS, b. in Hingham, d. in 1685; m., in Dorchester, MARY —. His Will, dated Jan. 26, 1684, proved May 21, 1686, mentions wife Mary, and chil. Mary, Rebecca, Nicholas, and Benjamin. He was of Charlestown in 1648.

1. Patience, b. in Dorchester, June 18, 1658, d. young.

2. Miry, 3. Rebecca; m. — Robinson.

4. Nicholas, m. (1st) Nov. 8, 1681, Mary Harris, by whom he had Patience, b. Aug. 12, 1682, not mentioned in her father's Will. Soon after this, he moved to Charlestown, where his wife Mary d., and there he m. (2d), Dec. 25, 1682, wid. Abigail (Lawrence) Wyer. [See the text.]

5. Benjamin.

2. MARY, b. in Dor.; m., Oct. 28, 1658, THOMAS MOSELEY, of Dorchester.

3. ELIZABETH, b. in D.; m., in 1658, WILLIAM SKEAD.

- bricklayer, of Medford, in 1724. He, and wife ANN, signed a deed in 1729. It is also supposed that he had an only son, *Nathaniel*, who married in Charlestown, May 9, 1710, *Sarah Belcher*, and died before his father; and that his wife ANN, d. before him. His Inventory was dated July 11, 1737, and his estate was administered by his brother Jonathan, in 1739. His heirs were Elisha and Sarah Tottingham, John Holden, wid. Sarah Lawrence,* wid. of his son Nathaniel, and his brother Jonathan Lawrence.
2. SARAH, b. in Sud., Jan. 1, 1662-3, d. soon.
 3. HANNAH, b. July 3, 1664, d. early.
 46. 25 4. JOHN, b. July 29, 1667; d. in Lex., Mar. 12, 1746.
 5. MARY, b. Mar. 3, 1669-70, d. early.
 26 6. SARAH, b. May 16, 1672. She was probably the first wife of that SAMUEL PAGE, who, in 1714, then of South Carolina, m. Sarah Sanderson. [See Page, 11.] As she d. before her father, she is not mentioned in his Will, but her surviving husband.
 7. ELIZABETH, b. July 6, 1674; d. Oct. 20, 1675.
 27 8. ELIZABETH, m. (pub. in Boston, Nov. 20, 1709), ABNER HARRIS, of Medford.
 28 9. DEBORAH, b. Mar. 24, 1683; (?) m. PETER TUFTS.
 (By 2d wife, Hannah.)
 29 10. HANNAH, b. Ap. 26, 1687; m. SAMUEL HOLDEN. [8.]
 31 11. MARY, b. Oct. 16, 1690; m. ZEBADIAH WHEELER.
 60. 31 12. JONATHAN, b. June 14, 1696.
-
6. 32 (II.) PELEG LAWRENCE, of Groton, m., 1668, ELIZABETH MORSE, b. Sept. 1, 1647, a sister of his brother Nathaniel's wife. He d. in Groton, 1692, aged 45, and admin. was granted Mar. 13, 1692-3, to wid. Elizabeth, son Samuel, and Nathaniel Lawrence, Jr. June 7, 1714, in Sherburne, Elizabeth Lawrence gave her dr.-in-law Abigail, wid. of her son Samuel, a receipt for money.
- 33 1. ELIZABETH, b. Jan. 9, 1669.
 34 2. SAMUEL, b. Oct. 16, 1671; (?) of Sherburne. Admin. on estate of Samuel Lawrence, of Sherburne, who d. in Killingby, Mar., 1712, was granted to wid. ABIGAIL, July 9, 1712. Inventory, dated Ap. 3, 1712, £87 16s.
 64. 35 3. ELEAZER, b. Feb. 28, 1674; of Littleton.
 36 4. JONATHAN, b. Mar. 29, 1679. He was probably the Jonathan, of Sherburne, who by wife ABIGAIL, had Jonathan, b. 1711.
 37 5. ABIGAIL, b. Oct. 6, 1681. 6. JEREMIAH, b. Jan. 3, d. Ap. 26, 1687.
 38 7. JOSEPH, b. June 12, 1688. Supposed to have settled in Plainfield, Conn., as early as 1712.
 39 8. DANIEL. 9. SUSANNA, named in the father's Inventory.
-
7. 41 (II.) ENOCH LAWRENCE, of Groton, m., in Wat., Mar. 6, 1676, RUTH SHAT-TUCK, wid. of John, of Wat. [4], and dr. of John, Jr., and Ruth Whitney, of Wat. [Whitney, 12.] He d. in Groton, Sept. 28, 1744, aged about 95.
75. 42 1. NATHANIEL, b. in Wat., Feb. 21, 1677-8.
 152. 43 2. DANIEL, b. in Groton, Mar. 7, 1681.
 186. 44 3. ZECHARIAH, b. July 16, 1683; of Pepperill.
 45 4. JEREMIAH, b. May 1, 1686.
-
25. 46 (III.) JOHN LAWRENCE, a blacksmith, and farmer, m., in Groton, Nov. 9, 1687, ANNA [Hannah] TARBALL [Tarball, 4]. She was a granddr. of William, Sen., and Joanna Longley, of Groton. [See Crispe, in Part II.] He moved from Groton to Camb. Farms (Lex.), where he and his wife were adm. f. c. Feb. 9, 1698-9. She d. Dec. 19, 1732, aged 63, and he d. Mar. 12, 1746-7, aged 79 y. 7 m. Chil.,

John Lawrence

* She was probably the widow Sarah Lawrence, who presented to the court the following petition, without date, signed by her name. "Since I was a wido some of the lawrences are my innemise, because my husband had a child by his made, and my troubles was so grate then, that I was troubled in minde, and I have been twited ever since by some of them for being crazy, but I never was crazed yet—have had a daughter with me that is very weakly, and been under the doctor's hands, and has vomited up her victuals four year or five, and has cost me £30.—bro't £1400, to my husband—has two children—has a brother." [In 1728, wid. Sarah Lawrence, of Stoneham, conveyed away all her right in Narragansett lands.]

204. 47 1. JOHN, b. June 10, 1688; d. Jan. 22, 1752.
214. 48 2. THOMAS, of Groton.
219. 49 3. WILLIAM, b. 1697; of Groton.
- 50 4. SAMUEL, b. July 9, 1700. By wife ELIZABETH, he had dr. *Ruth*, b. Jan. 21, 1725-6; m., May 15, 1741, *Thomas Hadle*, of Lex. [See Heady, 2.] Samuel, and wife Elizabeth, signed a deed, 1724-5.
- 51 5. ANNA, bap. Nov. 1, 1702; m. Capt. BENJAMIN BANCROFT, of Charlestown; both adm. f. c. Aug. 9, 1724. He d. in Groton, Ap. 3, 1790, aged 88, and she d. July 21, 1787, aged 86. Chil.,
- 52 1. *Benjamin*, b. in Charlestown, Sept. 29, 1724; a deacon, of Groton; m., Oct. 18, 1749, *Alice Turball* [87]. She d. Nov. 29, 1781, and he d. Oct. 27, 1804, aged 80. 8 chil. [Butler, p. 385.]
- 53 2. *Edmund*, b. in C., Nov. 23, 1726; m. (1st), Dec. 30, 1747, *Elizabeth Atherton*. He m. (2d) *Rachel H. Barron*. Chil.,
1. Edmund, b. Sept. 22, 1748; d. June 25, 1777.
2. Joseph, b. Ap. 13, 1750; d. Sept. 17, 1766.
3. Mary, b. Nov. 14, 1752; d. Oct. 17, 1755.
4. Maria, b. Ap. 17, d. Oct. 17, 1755.
- (By 2d wife, Rachel H. Barron.)
5. Anna, b. Feb. 8, 1758; m., Oct. 14, 1779, Hon. Timothy Farrar, LL.D., of New Ipswich. She d. May 1, 1817, and Judge Farrar d. Feb. 21, 1849, aged 101 yrs. 8 months. [See Farrar Family, pp. 20-30.]
6. Jonathan, b. Jan. 5, 1761. 7. Joseph, b. Jan. 7, 1763.
8. Thomas, b. Oct. 26, 1764; (?) grad. Harv. Coll., 1788; d. 1807.
9. Amos, b. May 28, 1767; grad. Harv. Coll., 1791; M.B., 1794; M.D., 1811, M.M.S.S.; of Groton, d. 1848.
10. Rachel, b. Mar. 21, 1769. 11. Luther, b. Ap. 30, 1771.
12. Elizabeth, b. Sept. 21, 1773.
- 54 3. *Anna*, b. in Groton, Dec. 20, 1728; d. Nov., 1806.
4. *Mary*, b. Ap. 4, 1731; d. Dec. 1, 1732.
5. *Joseph*, b. Sept. 5, 1732; d. Nov. 24, 1737.
6. *Mary*, b. Feb. 6, 1735; d. Nov. 25, 1737.
7. *Joseph*, b. Aug. 1, 1738; d. Nov. 2, 1745.
8. *Sarah*, b. Nov. 2, 1740; d. Nov. 2, 1745.
9. *Jonathan*, b. Jan. 27, 1743; d. Oct. 26, 1745.
226. 55 6. JONATHAN, b. Feb. 24, 1705-6; of Lex.
- 56 7. SARAH, b. June 20, 1708; m. JOSIAH FISKE. [N. Fiske, 52, Part II.]
- 57 8. ISAAC. ?
- 58 9. BENJAMIN, b. May 24, 1713; m., Feb. 12, 1734-5, JANE RUSSELL, b. July 19, 1711, dr. of Jonathan and Elizabeth, of Lex. They were dismissed from Lex. to Westboro, July 3, 1737; and from W. to Boston, Feb. 26, 1749. In Westboro, they had,
1. *Benjamin*, b. Nov. 22, 1735; d. Oct. 19, 1736.
2. *Abigail*, b. Aug. 20, 1737. 3. *Submit*, bap. Aug. 5, 1739.
4. *Elizabeth*, bap. Ap. 12, 1741. 5. *Ann*, bap. Sept. 26, 1742.
6. *Jane*, bap. Oct. 7, 1744.
234. 59 10. AMOS, b. Feb. 19, 1715-16; of Groton.
-
31. 60 (III.) Dea. JONATHAN LAWRENCE, first of Charlestown, where he was taxed in 1729, afterwards of Stoneham; m. HANNAH ——. He was an active, useful man in the parish and town business, until near his decease, which is said to have occurred about 1774, then aged nearly 80 yrs.
-
241. 61 1. JONATHAN, b. in Charlestown, Dec. 27, 1724, of Woburn.
- 62 2. EBENEZER, m., in Groton, Ap. 2, 1754, wid. SARAH BASON; lived with his father in Stoneham, was much engaged in town affairs, and is supposed to be the father of *Ebenezer Lawrence*, b. in Stoneham, Sept. 19, 1769.
-
35. 64 (III.) Major ELEAZER LAWRENCE, first of Groton, where his chil. were b.; afterwards of Littleton, and in the settlement of his estate, Dec. 19, 1754, said to be of Pepperill. He m. MARY ——. He d. Mar. 9, 1754, aged 80, and his wid. d. June 29, 1761, aged 82. His Will, dated Dec. 29, 1749, mentions wife Mary; sons, Peleg, Jonathan, David, Eleazer, and Samuel; heirs of dr. Elizabeth But-

trick; drs. Mary Fletcher, Sarah Cummings, Experience Keep, and Prudence Parker. Among his heirs were Benjamin and Sarah Davis, Isaac and Mary Russell, probably heirs of dr. Elizabeth. May 24, 1721, he gave bond as guardian of Ephraim Whitcomb. Chil.

- 65 1. ELIZABETH, b. Feb. 28, 1699; m. — BUTTRICK, and died before her father, leaving heirs.
255. 66 2. PELEG, b. June 1, 1701; of Pepperill.
282. 67 3. JONATHAN, b. Oct. 4, 1703; of Littleton.
- 68 4. DAVID, b. Dec. 26, 1705; d. Sept. 28, 1790, aged 85.
332. 69 5. ELEAZER, mentioned in his father's Will.
- 70 6. MARY, m. — FLETCHER.
- 71 7. SARAH, m., in Groton, Jan. 28, 1735-6, JOHN CUMMINGS, of Groton. 7 chil. [Butler; p. 393.]
339. 72 8. SAMUEL, b. May 2, 1714, of Ashby.
- 73 9. EXPERIENCE, b. June 22, 1719; m. JABEZ KEEP.
- 74 10. PRUDENCE, b. Ap. 7, 1722; m., Mar. 4, 1742, PETER PARKER, b. Aug. 6, 1719, son of James and Abigail (Prescott) Parker, of Groton. 4 chil.
- †75 1. Eleazer, b. Ap. 4, 1743; m., Jan. 22, 1767, *Abigail Lawrence* [192].
- †76 2. Sybil, b. Nov. 6, 1745; m., Nov. 21, 1769, *Benjamin Lawrence* [140].
- †77 3. Peter, b. Jan. 15, 1747; (?) of Shirley, wife Mary.
- †78 4. James, b. Aug. 23, 1751; (?) of Shirley, wife Sarah. 10 chil.

42. 75 (III.) NATHANIEL LAWRENCE, of Groton, m. ANNA (Hannah) —. She d. Sept. 30, 1758, aged 73 yrs. 8 m. 21 d.; and he d. Sept. 12, 1765, aged 87 yrs. 6 m. 21 d. Chil.

- 76 1. NATHANIEL, b. May 3, 1702; of Groton; m., Feb. 4, 1728-9, DOROTHY CHAMBERLIN. His Will, dated Aug. 30, proved Oct. 4, 1775, mentions wife Dorothy, dr. Dorothy Hudson; sons Thomas and Isaac; drs. Abigail Gilson, Eunice, and Martha. Son John, executor. Chil.
- 77 1. Dorothy, b. Feb. 8, 1729-30; m. *Benaiah Hudson*, of Pepperill. Chil.
- 78 1. Dorothy, b. Dec. 20, 1754. 2. Benjamin, b. July 31, 1757.
- 80 3. Elizabeth, b. Sept. 18, 1759. 4. Abigail, b. July 15, 1761.
- 82 5. Rachel, b. Feb. 17, 1764. 6. Jane, b. June 16, 1766.
- 84 7. William, b. Aug. 19, 1768.
- 85 2. Nathaniel, b. May 24, 1732; probably d. young.
- 86 3. Thomas, b. Aug. 18, 1734, of Pepperill; m. Sarah —. Chil.
- 87 1. Thomas, b. Ap. 19, 1758. 2. Sarah, b. May 28, 1760.
- 89 3. Ezekiel, b. July 2, 1762. 4. Nicholas, b. Sept. 18, 1764.
- 91 5. John, b. Aug. 30, 1766. 6. Mary, b. Nov. 30, 1768.
- 93 7. David, b. June 2, 1771. 8. Jonas, b. Oct. 24, 1773.
- 95 4. Isaac, b. Jan. 8, 1736-7; of Groton; m., Mary —. Chil.
- 96 1. Isaac, b. Oct. 30, 1759. 2. Benjamin, b. July 15, 1761.
- 98 3. Mary, b. Sept. 3, 1763. 4. Dorothy, b. July 29, 1766.
- †90 5. Eunice, b. Ap. 9, 1767. 6. Nathaniel, b. July 29, 1769; of Dunstable.
- †92 7. Lydia, b. Ap. 21, 1772.
- †93 8. Daniel, b. Sept. 14, 1774. Nov. 26, 1798, Nathaniel Lawrence, of Dunstable, was appointed administrator of the estate of his brother Daniel, at the request of his father, Isaac.
- †94 9. Martha, b. Nov. 3, 1777. 10. Anna, b. Jan. 2, 1781.
- †96 11. Susanna, b. May 13, 1783.
- †97 5. Abigail, b. June 21, 1739; m. *Nehemiah Gilson*. Chil.
- †98 1. Nehemiah, b. July 10, 1766. 2. Nathaniel, b. Mar. 24, 1768.
- 100 3. Sybil, b. June 9, 1770. 4. Jacob Blanchard, b. Sept. 5, 1772.
- 102 5. Oliver, b. Mar. 15, 1776. 6. Nabby, b. Dec. 15, 1777.
- 104 7. Asahel, b. Feb. 27, 1780. 8. Isaac, b. Sept. 26, 1783.
- 106 6. John, b. Nov. 13, 1741.
- †107 7. Eunice. 8. Martha.
- 107 2. JAMES, b. Aug. 26, 1705; a Captain, of Groton; m., Feb. 20, 1732-3, MARY MARTIN, b. Ap. 30, 1713, eldest child of Benjamin and Sarah, of Groton. She d. 1799, aged 77, and he d. in Pepperill, Jan. 27, 1800, aged 96. Admin. granted to his son Benjamin, Oct. 22, 1800.

- 108 1. *Mary*, b. Mar. 17, 1734; m., in Groton, Mar. 19, 1754, *Isaac Lakin, Jr.*
11 chil. [Butler, p. 412.]
- 109 2. *James*, b. Ap. 11, 1736; of Pepperill; m., Sept. 21, 1756, *Elizabeth Fiske*
[? divorced in 1797]. Chil.,
- 110 1. Molly, b. Feb. 13, 1757. 2. *Elizabeth*, b. Dec. 15, 1759.
- 112 3. *Tamar*, b. May 2, 1762. 4. *Patience*, b. May 29, 1764.
- 114 5. *James*, b. Jan. 20, 1767; a cordwainer, of Pepperill. His estate was
admin. Oct. 26, 1816, by Josiah Williams (?) who had m. his widow,
Anna. Chil., 1. *Luther*, d. 2. *Nancy*, wife of Jonas Kemp. 3. *Matilda*.
In 1818, guardians were appointed for Aaron, Charles, John W., and
Noah, sons of James Lawrence, upwards of 14 years old.
- 115 6. *Absalom*, b. Mar. 11, 1770. 7. *Abel*, b. Ap. 24, 1772.
- 117 8. *Huldah*, b. Feb. 13, 1775.
- 118 3. *Lemuel*, b. June 1, 1745, d. Ap. 24, 1773; of Pepperill; m., Jan. 21, 1768,
Sarah Williams. Chil.,
- 119 1. *Sarah*, b. Oct. 13, 1768. 2. *Lemuel*, b. Aug. 6, 1770.
- 121 3. *Olive*, b. Feb. 13, 1772.
- 122 4. *Benjamin*, b. Oct. 19, 1747, of Pepperill; m., in Groton, Nov. 21, 1769, *Sybil*
Parker, b. May 1, 1744, dr. of Wm. and Susanna (Kemp) Parker, of Groton.
She d. Nov. 28, 1797. Chil.,
- 123 1. *Prudence*, b. Oct. 21, 1770. 2. *Jesse*, b. Mar. 1, 1774.
- 125 3. *Benjamin*, b. June 1, 1780. 4. *Jacob*, b. June 16, 1784.
- 127 3. *ANNA*, b. July 3, 1708; (?) m., Jan. 18, 1732-3, *SAMUEL WRIGHT*. 7 chil.
357. 128 4. *ENOCH*, b. Nov. 15, 1710, of Pepperill.
- 129 5. *SARAH*, b. Mar. 15, 1713; m., Dec. 15, 1734, *ZECHARIAH LAWRENCE, Jr.* [187.]
- 130 6. *MARTHA*, b. Dec. 7, 1715; m., Feb. 11, 1735-6, *WILLIAM BLOOD*, of Groton.
- 131 She d. soon, leaving one child, *Martha*, b., Jan. 25, 1736-7; m. *John Nutting*.
- 132 7. *JOSEPH*, b. Ap. 10, 1718; first of Groton, afterwards of Pepperill; m. *ELIZABETH*
Chil.,
- 133 1. *Elizabeth*, b. in G., Oct. 11, 1739; m., Oct. 18, 1759, *Whitcomb Powers*, of
Hollis.
- 134 2. *Zeruiah*, b. in G., Mar. 23, 1741; m. in Pepperill, Sept. 24, 1767, *Josiah*
Nutting, b. in Groton, Feb. 16, 1748, and in P. had 8 chil. [Butler, p. 476.]
- 135 3. *Anna*, b. in G., Dec. 1, 1743. 4. *Lucy*, b. in G., May 7, 1747.
- 137 5. *Joseph*, b. in Pepperill, Ap. 6, 1749; m., Ap. 9, 1771, *Lydia Shattuck*.
1. *Joseph*, b. Feb. 15, 1773. 2. *Lydia*, b. Mar. 9, 1775.
3. *Phebe*, b. Mar. 16, 1777. 4. *Eunice*, b. July 16, 1780.
5. *Sybil*, b. July 16, 1782.
6. *Abraham*, b. Ap. 19, 1784, d. July 16, 1806, and his estate admin. by
his father.
7. *Abijah*, b. Feb. 25, 1786, d. 1808. 8. *Lewis*, b. Ap. 25, 1788, d. 1816.
8. *Joshua*, b. Feb. 3, 1790, d. 1812. 10. *Bryant*, b. Ap. 22, 1795.
- 138 8. *BENJAMIN*, b. Nov. 6, 1720; a lieutenant, of Groton; m., in Groton, June 20,
1744, *RUTH DODGE* [Butler, p. 415, says Rebecca]. He d. 1807, aged 87, and
admin. granted to son Salmon, Oct. 22, 1807.
- 139 1. *Rebecca*, b. Jan. 10, 1744-5; m., Oct. 5, 1775, *Ezra Peirce*.
- 140 2. *Benjamin*, b. Sept. 1, 1746; of Pepperill; m., in Groton, Nov. 21, 1769,
Sybil Parker, dr. of Peter and Prudence (Lawrence, [†76]) Parker.
- 141 3. *Anna*, b. Nov. 14, 1748; m. *John Fisk*. 4. *Margaret*, b. Jan. 3, 1751.
- 143 5. *Sarah*, b. Ap. 2, 1753; m., July 14, 1774, *Abel Bancroft*, b. May 28, 1752,
son of Dea. Benjamin, Jr., and Alice (Tarball) Bancroft, [see 52, p. 823].
- 144 6. *Phebe*, b. Oct. 19, 1755; m. *Nehemiah Peirce*, b. Aug. 1, 1756, son of Simon
and Susanna (Parker) P., of Groton.
- 145 7. *Ruth*, b. Jan. 3, 1758; m. — *Ames*; was a wid. in 1807.
- 146 8. *Rachel*, b. Mar. 16, 1760; unm. in 1807.
- 147 9. *Deborah*, b. July 1, 1762; m. *Jonathan Sheple*.
- 148 10. *Salmon*, b. Ap. 23, 1765.
- 149 9. *REBECCA*, b. Ap. 17, 1724.
- 150 10. *LOIS*, b. Sept. 26, 1726; m., Dec. 17, 1751, *BEZALEEL SAWYER*, of Lancaster.
- 151 11. *EUNICE*, b. July 25, 1728; d. Nov. 15, 1747, aged 19 years.

43. 152 (III.) *DANIEL LAWRENCE*, of Groton, m. *SARAH* —, and had at least two
children b. in Groton. About 1707, he moved to Plainfield, Conn., in that part

which became the town of Killingby. He is said to have had 2 wives and 22 children, and late in life, to have gone to Norfolk, Conn., to live with his son John, where he probably died. His son Isaac gave the use of a farm to his half brother John, as a compensation for taking care of their father. In 1711, Daniel Lawrence purchased land of David Russell. In 1719-20, he, then of Plainfield, executed a deed, without the name of wife attached. July 2, 1743, he sold land to his son Samuel. [See Genealogy of the Ancestors and Posterity of Isaac Lawrence, by Frederick S. Pease, of Albany.] The names of only a few of his children have been ascertained.

- 153 1. DANIEL, b. in Groton, Ap. 22, 1702. He built and kept a tavern, the house in which John Wadsworth lived and died, a short distance east of Konkapot River. From this house he moved to Sheffield, where he died. Chil.,
- 154 1. *Nathaniel*. By his 1st wife, *Sarah*, he had, 1. *Martha*. 2. *Anson*. By his 2d wife, *Elizabeth*, 3. *Silas*. 4. *Kezia*. 5. *Nathaniel*. 6. *Phebe*, who m. *Josiah Lawrence* [675].
- 162 2. *Gideon*. 3. *Stephen*. 4. *Rufus*. 5. *Sarah*. 6. *Sybil*. 7. *Lois*. 8. *Esther*. One of his drs. m. — *Fellows*, and was mother of the late Mr. Isaac Fellows.
366. 169 2. ISAAC, b. in Groton, Feb. 25, 1704-5.
(By 2d wife.)
- 170 3. JOHN, a major, of Norfolk, Conn., at whose house his father died.
- 171 4. JEREMIAH. He m. (1st) OLIVE WHEELER. 3 chil. He m. (2d), BETSEY SMITH, sister of Willard and Obadiah Smith. 1 child. He m. (3d) wid. HIGBY, maiden name Clarke. Chil.,
- 172 1. *David*, had 2 wives. *Nathan*, a son by his first wife, had
1. *George*. 2. *Lewis*. 3. *Leonard*. 4. *Lucy*. 5. *Wealthy*. One of his drs. m. *Samuel Rood*.
- 173 2. *Jonathan*. By 1st wife had *Joseph*, father of *John*, *Benjamin*, and *Betsey Ann*.
- 174 3. *Nehemiah*, a capt., of Canaan; had 3 wives; lived in a red house, on the north side of the road, about half a mile east of Konkapot River. He had 4 chil. by his first 2 wives. He m. (3d), 1787, the wid. of Dr. Edward Sutton, and a dr. of Col. Charles Burrall, of Canaan. He d. in Canaan, July 2, 1800, aged 72, and she d. in Colebrook, Conn., Ap. 1838, aged 91. 2 chil. by 3d wife, viz.,
- 175 1. *Charlotte*, b. Jan. 1788; m., Oct. 1809, *Alpha Sage*, a merchant, of Colebrook, Conn.
- 176 2. *Ville*, b. Dec. 6, 1789. Soon after the death of his father, he went to Vermont, and settled in Vergennes. Gen. *Ville Lawrence* m., Dec. 4, 1814, *Betsey Woodbridge*, dr. of Hon. *Enoch Woodbridge*. She d. Nov. 21, 1830, leaving 6 chil.,
(By 2d wife, *Betsey*.)
- 177 4. *Putnam*, a blacksmith and farmer. Chil., 1. *Thankful*, m. *Daniel White*.
- 179 2. *William C*. 3. *Mary Ann*, m. *John Watson*.
- 181 4. *Adaline*, m. — *Lewis*. 5. *Caroline*. 6. *Nancy*.
- 184 7. *Henry*, m. *Abigail Doolittle*.
- 185 5. *William*.
-
44. 186 (III.) ZECHARIAH LAWRENCE, of Groton, m. about 1707, ABIGAIL, a grand-dr. of Dea. James Parker, of Groton. He m. (2d), Sept. 17, 1740, LUCY LAKIN, wid. of Josiah Lakin, of Groton, s. p. [Jan. 5, 1768, Ebenezer Lakin, Sarah Green, and John Scott, asked for administration to be granted on the estate of mother Lucy Lawrence.] He (Z. L.) d. in Pepperill, June 18, 1754, aged 71 yrs.
- 187 1. ZECHARIAH, b. May 8, 1708; m., in Groton, Dec. 5, 1734, SARAH LAWRENCE. [129.] Chil.,
1. *Sarah*, b. Oct. 2, 1735; d. May 20, 1738.
- 188 2. *Sarah*, b. Ap. 7, 1738. 3. *Daniel*, b. Feb. 24, 1740-1.
- 190 2. RUTH, b. Sept. 3, 1710; m., Dec. 18, 1729, ELIAS ELLIOT. Chil. b. in Groton.
1. *William*, b. July 22, 1730. 2. *Rachel*, b. Aug. 10, 1732.
3. *Oliver*, b. Aug. 24, 1734. 4. *Jeremiah*, b. May 22, 1737.
5. *Abigail*, b. Mar. 16, 1740. 6. *Elizabeth*, b. July 4, 1743.

- 191 3. JEREMIAH, b. Dec. 7, 1713; m., Mar. 23, 1736-7, ELIZABETH CHAMBERLIN. He and his wife were dismissed, Jan. 29, 1748-7, from Groton to the church in Pepperill, of which he was elected a deacon, Jan. 11, 1748. His epitaph is: "He was a man of unfeigned sincerity, strict religious and experimental piety. He lived beloved, and died universally lamented, with a full assurance of going to rest, Aug. 29, 1759, aged 47 yrs." His wid. d. Feb. 1, 1774, aged 60, and admin. granted Feb. 2, 1779. Chil.,
- 192 1. *Abigail*, b. Aug. 16; d. Sept. 18, 1738.
2. *Abigail*, b. Aug. 22, 1739; (?) m., Jan. 22, 1767, *Eleazer Parker*, b. Ap. 4, 1743, son of Peter and Prudence (Lawrence) Parker. [Lawrence, †75.]
- 193 3. *Mary*, b. Jan. 8, d. Jan. 27, 1743-4.
4. *Elizabeth*, b. May 19, 1745; m. (?) *Ebenezer Gibson*.
- 194 5. *Jeremiah*, b. July 30, 1750; ? m., in Pepperill, Feb. 1, 1774, *Anna Woods*.
- 195 1. *Jeremiah*, b. Mar. 8, 1775; admin. granted Oct. 18, 1803.
196 2. *Nathaniel*, b. Mar. 14, 1777. 3. *Anna*, b. July 29, 1779.
198 4. *Betsey*, b. Nov. 22, 1788.
199 6. *Esther*, b. (?) m., Oct. 29, 1767, *John Page*.
- 200 4. JOSIAH, b. July 4, 1715, d. soon.
201 5. ABIGAIL, b. May 11, 1718; m., Nov. 23, 1737, ZERUBABEL KEMP, Jr. 3 chil.
202 6. ELIZABETH, b. Oct. 15, 1720; (?) m., Nov. 12, 1741, JOHN MOSIER, of Groton. 8 chil. [Butler, p. 475.]
- 203 7. JOSIAH, b. Oct. 11, 1723; m., Dec. 3, 1746, ELIZABETH LAKIN, (?) dr. of James and Elizabeth (Williams) Lakin.
8. RACHEL, b. 1727; d. Oct. 6, 1756; m., Dec. 3, 1746, JOHN CHAMBERLIN, Jr. Chil.,
1. *Rachel*, b. July 10, 1747; d. Oct. 13, 1756. 2. *Abigail*, b. Sept. 8, 1749.
3. *John*, b. Feb. 27, 1752. 4. *Ede*, b. Oct. 9, 1754.
-
47. 204 (IV.) JOHN LAWRENCE, of Lex., m., May 18, 1710, ELIZABETH STONE, b. June 19, 1693, dr. of Dea. Samuel and Dorcas (Jones) Stone, of Lex. [See I. Stearns. App. I., 15.] He d. Jan. 22, 1752, aged 63. "At the first precinct meeting of that part of Woburn, now called Burlington, held Nov., 1730, John Lawrence was chosen Collector. In a tax of £400, granted Mar. 29, 1732, towards building a meeting-house, assessed upon 110 persons, his rate of £10 8s. 7d., was the highest on the list except one." In the settlement of his estate, 1755, George Tilley was guardian of his (G. T.'s) sons.
-
- 205 1. ELIZABETH, b. May 12, 1711; m., in Woburn, June 22, 1732, THOMAS DITSON, of Billerica.
206 2. JOHN, b. Sept. 21, 1713; m., in Woburn, Oct. 23, 1736, MARY SIMONDS. "He lived a while in Medford, and went to Maine."
207 3. SAMUEL, b. Oct. 3, 1715, } Samuel and Isaac, both living, July 7, 1755, and
208 4. ISAAC, b. Nov. 27, 1717, } acted by their att'y in settling their father's estate.
209 5. ANNA, b. Aug. 8, 1720; m., in Woburn, May 12, 1740, JAMES SIMONDS, of Woburn.
210 6. NATHANIEL, by wife BETHSHEBA, had a dr. *Olive*, b. in Woburn, Mar. 24, 1749; in 1754, he went to New Hampshire; July 7, 1755, he acted by att'y in the settlement of his father's estate.
211 7. REBECCA, b. 1728; m. (1st), June 27, 1751, THOMAS LOCKE, of Lex., b. Oct. 22, 1722, son of William and Jemima (Russell) L., of Lex. He d. Feb. 21, 1792, aged 70, and his wid. m., Jan. 3, 1795, NOAH EATON. She d. Mar. 14, 1814, aged 86. [See Locke Family, p. 38.] One child.
212 1. *Thomas* (Locke), b. Aug. 21 or 29, 1756; m., Nov. 5, 1778, *Lydia Reed*.
213 8. MARY, m., in Woburn, May 30, 1738, WILLIAM TUTTLE. She d., and in 1755, her mother, Elizabeth Lawrence, was guardian of her dr. *Mary*.
-
48. 214 (IV.) THOMAS LAWRENCE, of Groton, m., 1713, PRUDENCE ——. It is supposed that he d. in 1729, and that it was his wid. Prudence, who m., in Groton, Jan. 5, 1731-2, SHADRACH WHITNEY, of North Town. [See Butler, p. 208.] Chil.,
215 1. PRUDENCE, b. Sept. 14, 1715; m., July 18, 1732-3, SAMUEL CUMMINGS, Jr.
216 2. MARY, b. Sept. 7, 1718; (?) m., Feb. 1, 1738-9, JOHN LONGLEY, Jr. In 1732, she chose Jona. Boyden, guardian.

381. 217 3. THOMAS, b. Sept. 3, 1720; of Pepperill.
 395. 218 4. JONATHAN, b. Sept. 2, 1725; of Groton.
-
49. 219 (IV.) Col. WILLIAM LAWRENCE, of Groton, m., June 27, 1722, SUSANNA PRESCOTT, b. Dec. 31, 1691, dr. of Jonas and Mary (Loker) Prescott, of Groton. He d. May 19, 1764, aged 67, and his wid. d. 1771, aged 80. He was a Colonel, a Justice of the Peace, and of the Quorum, and was many times Representative of Groton. The epitaphs on their gravestones in Groton, are delineations of characters of high esteem and great worth.
419. 220 1. WILLIAM, b. May 7, 1723; grad. Harv. Coll., 1743; of Lincoln.
 221 2. SUSANNA, b. Feb. 5, 1725; m., June 8, 1752, her cousin, Hon. JAMES PRESCOTT, of Groton. 8 chil. [Butler, p. 429.]
 222 3. ANNA, b. Jan. 29, 1727-8; d. 1791; m., July 7, 1748, ISRAEL HOBART. 10 children. [Butler, p. 407.]
440. 223 4. ABEL, b. Feb. 25, 1729-30; of Groton; d. Sept. 20, 1770.
 224 5. SARAH, b. Mar. 12, 1732; d. 1778; m., Oct. 23, 1755, Rev. JOSEPH PERRY, grad. Harv. Coll., 1752; d. 1783; minister, of East Windsor, Conn.
 225 6. PHEBE, b. Sept. 20, 1734; m., Sept. 30, 1756, JONATHAN BANCROFT, of Danvers.
-
55. 226 (IV.) JONATHAN LAWRENCE, of Lex., m., Feb. 26, 1726-7, ELIZABETH SWAIN, of Lex., b. 1707. He d. Mar. 19, 1773, aged 68, and his wid. d. July 4, 1790, aged 83. He settled first in Sudbury, afterwards in Framingham, where he was residing in 1736. In 1736, John Lawrence, of Lex., executed a deed in favor of his son Jonathan, of Fram.; soon after this, he returned to Lexington. "Dec. 28, 1761, an order was passed (in town meeting) to pay Jonathan Lawrence, £2 13s. 4d., for his wife's keeping one of the women's schools." The following is a clause in his Will: "I give my negroes among all my children, to be settled among them as they shall agree, as soon as may be after my decease." He held various offices of duty and trust in the town. Chil.,
1. ELIZABETH, b. in Sud., Feb. 19, 1727-8; d. Jan. 16, 1732-3.
 227 2. MARY, b. in Fram., Nov. 30, 1729; m., Jan., 1750, ABEL SMITH, of Lex. [Smith, 54.]
 228 3. SARAH, b. in F., Dec. 15, 1731; m., Jan. 30, 1752, Col. JONATHAN REED, (?) b. Mar. 8, 1729, son of Capt. Benjamin and Rebecca (Stone) Reed, of Lex., and settled in Littleton.
457. 229 4. JONATHAN, b. in F., Feb. 5, 1733-4; of Woburn, afterwards of Ashby.
 479. 230 5. BEZALEEL, b. (probably in F.) Ap. 13, 1736; of Lexington.
 498. 231 6. MICAH, b. Mar. 15, 1738-9; of Winchester, N. H.; grad. Harv. Coll., 1759.
 232 7. ELIZABETH, b. Dec. 13, 1741; m., Nov. 7, 1764, THADDEUS BOWMAN, of Lex. [Bowman 188.], Part II.]
 8. ANNA, b. Mar. 19, 1745-6; d. July 18, 1753.
510. 233 9. JOHN, b. June 5, 1748; of Ashby.
 10. BENJAMIN, b. Sept. 13, 1750; d. June 19, 1753.
-
59. 234 (IV.) Lieut. AMOS LAWRENCE, of Groton; m., Nov. 7, 1749, ABIGAIL ABBOT, b. in Lex., Jan. 26, 1721, dr. of Dea. Nehemiah and Sarah (Foster) Abbot, first of Weston, afterwards of Lexington. [See Abbot, p. 1, and see Reg. of Abbot Family, p. 151.] She d. Jan. 6, 1784. He d. June 20, 1785, aged 70.
-
516. 235 1. AMOS, b. Sept. 9, 1750; of Groton.
 236 2. NEHEMIAH, b. Jan. 14, 1752; m. ESTHER ——. He d. July 13, 1786. Inventory dated Sept. 19, 1786, leaving wid. Esther, and 4 chil., viz.:—
 237 1. Sally, b. Ap. 3, 1775. 2. Polly, b. Nov. 4, 1777.
 239 3. Esther, b. Nov. 8, 1780. 4. Sukey, b. Sept. 22, 1782.
520. 240 3. SAMUEL, b. Ap. 24, 1754; of Groton.
 4. ASA, b. Jan. 1, 1756; d. Nov. 6, 1759.
-
61. 241 (IV.) JONATHAN LAWRENCE, of Woburn, m., 1750, RACHEL WRIGHT, of W., where he d. Aug. 1, 1793, aged 68.
- 242 1. JONATHAN, b. May 24, 1752; of Ashby, where he was a deacon, and d. 1817, aged 65. A son settled in Nashville, Tenn.

- 243 2. JOSEPH, b. Nov. 12, 1754; of Woburn, d. 1836, aged 81.
- 244 3. EBENEZER, b. Oct. 16, 1757; of Woburn; a soldier in the Revolutionary war, and afterwards a deacon. He m., Ap. 6, 1785, HANNAH ESTABROOK, of Lex. [Estabrook, 11-2.] He d. Jan. 12, 1842, æt. 85.
- 245 1. Ebenezer, b. 1786 or 7; (?) d. Jan. 11, 1807.
- 246 2. Nathaniel, b. July 12, 1791. 3. Jonathan, b. June 8, 1794.
- 247 4. Melisent, b. May 17, 1796; d. 1842; m., 1816, Jacob Pierce, of Wob.
- 248 5. Hannah, b. Sept. 27, 1799; m., 1829, Rev. James Cushing, of Boxboro.
- 249 4. RACHEL, b. Oct., 1760.
- 250 5. NATHANIEL, b. July 2, 1764; grad. Harv. Coll., 1787 [in the catalogue, Laurence]; ordained in Tyngsboro, Jan. 6, 1790; m., May 24, 1794, HANNAH SODEN, bap. Mar. 4, 1764, dr. of Samuel and Susanna (Mason) Soden, of Wat. [See Soden, and see Mason, 23.] In 1815, he wrote the History of Tyngsboro, which was published in the Mass. Hist. Collections. During his long ministry there were 255 baptisms; 326 marriages; 121 admitted to the church; and 400 deaths. His wife, Hannah, d. Sept. 20, 1835, and he d. suddenly Feb. 5, 1843.
- 251 1. Susanna Soden, b. June 22, 1795; m. Timothy Davis, of Billerica; had chil., and d. July 3, 1831.
- 252 2. Samuel Soden, b. Mar. 24, 1797; of Tyngsboro; m., June 16, 1828, Mrs. Elizabeth Ruggles Prentiss, of Boston.
- 253 3. Nathaniel, b. Mar. 8, 1803; d. Aug. 19, 1835.
- 254 4. Hannah, b. Nov. 9, 1809; d. Nov. 27, 1832.
-
66. 255 (IV.) Dea. PELEG LAWRENCE, first of Groton, where his children were born, afterwards of Pepperill; m. RUTH ——. He was dismissed from Groton (first) Church, to the West Parish (Pepperill), Jan. 29, 1746-7, where he was chosen deacon, Aug. 23, 1754, and d. July 27, 1757, aged 57. His wid. Ruth, d. Sept. 4, 1757. His epitaph is:—
- “A man of Wisdom, Prudence, Honesty,
Public Spiritedness, and Piety,
The Poor Man's Friend.
Blessed are the Dead, who die in the Lord.”
-
- 256 1. OLIVER, b. Mar. 18, 1728; of Hollis, N. H.; m., 1751 or 2, MARY ——. He d. Ap. 2, 1797, aged 69, and his wid. Mary, d. July 20, 1799, aged 66. Chil.,
- 257 1. Mary, b. Nov. 4, 1753; d. Jan. 31, 1756. 2. Oliver, b. Oct. 7, 1755.
- 258 3. Peleg, b. Aug. 7, 1757. 4. Noah, b. Nov. 3, 1760.
- 260 5. Daniel, b. Ap. 26, 1762; of Hollis; m., May 6, 1790, Polly Johnson, of Hollis. He d. (?) about 1823. Chil.,
1. Daniel, b. June 16, 1791; d. young. 2. Betsey, b. Oct. 20, 1792.
3. Charlotte, b. Sept. 5, 1794. 4. Ruth, b. Nov. 21, 1796.
5. Daniel, b. Ap. 7, 1798; m., (?) 1825, Sarah Fletcher, of Pepperill.
6. Abigail, b. June 10, 1800. 7. Luther, b. Ap. 14, 1803.
8. Louisa, b. June 14, 1807. 9. Caroline, b. Mar. 23, 1810.
10. Mark, b. Aug. 20, 1811.
- 261 6. Silas, b. June 19, 1764. 7. Molly, b. May 25, 1767; d. Ap. 22, 1799.
- 262 8. Amos, b. Aug. 6, 1769.
- 263 9. Eber, b. Oct. 28, 1771.
- 264 10. Aaron, b. May 5, 1774. 11. Sarah, b. Oct. 4, 1777.
- 267 2. RUTH, b. Jan. 28, 1730.
3. MARTY, b. Mar. 23, 1733; m., in Groton, Mar. 19, 1754, ISAAC LAKIN, JR., of Groton, b. Dec. 6, 1727, son of Isaac and Elizabeth (Shattuck) Lakin. Chil.,
1. Molly, b. May 5, 1755. 2. Isaac, b. Mar. 1, 1758.
3. Eunice, b. July 27, 1760. 4. Naomi, b. Ap. 13, 1762.
5. Rachel, b. Oct. 12, 1764. 6. David, b. May 15, 1767.
7. James, b. Nov. 13, 1769. 8. Elizabeth, b. Nov. 19, 1771.
9. Lemuel, b. Oct. 9, 1773. 10. Jonas, b. July 16, 1776.
11. Sybil, b. May 20, 1780.
- 268 4. EPHRAIM, b. Mar. 31, 1735; a physician, of Pepperill; m., Mar. 3, 1768, ANAN FISKE [?N. Fiske, 74]. She d. June 12, 1774, aged 27, and he m. (2d), RUTH

- Admin. on his estate was granted to his son Ebenezer in 1812. He left wid. Ruth. Chil.,
- 269 1. *Ebenezer*, b. Jan. 9, 1770; grad. Harv. Coll. 1795; a physician, now (1848) living in Hampton, N. H. He m. in 1800, *Abigail Levitt*, and had a large family of children.
- 270 2. *Anna*, b. July 26, 1772; m. *Isaac Brown Farrar*, of New Ipswich [Farrar, 14, p. 728].
(By 2d wife, Ruth.)
- 271 3. *Ruth*, b. Ap. 8, 1777. 4. *Sarah*, b. Ap. 18, d. Dec. 16, 1779.
- 272 5. *George W.*, b. Oct. 1, 1780; m. *Dorcas True*; d. in Charlestown, N. H.
- 273 6. *Sarah*, b. Aug. 28, 1782.
- 274 7. *Mary Emerson*, b. Nov. 27, 1784; m. *Luther Lakin*, d. in Troy, N. Y. 1830.
- 275 8. *Theodosia*, m., for her 2d husband, *Luther Lakin*.
- 276 5. *Asa*, b. June 14, 1737; a Captain, of Groton; m., July 27, 1758, *ABIGAIL*, dr. of Richard King, of Littleton. Chil.,
1. *Elizabeth*, b. Sept. 4, 175-, d. June 22, 1785.
2. *Rowland*, b. Mar. 25, 1763, d. June 17, 1812.
- 277 3. *Roger*, b. Mar. 6, 1764. 4. *Ephraim*.
5. *Didamia*, b. Aug. 24, 1771, d. Oct. 18, 1778.
6. *Philomela*, b. Oct. 22, 1773, d. Aug. 18, 1775.
7. *Horatio Gates*, b. June 11, 1777, d. Oct. 28, 1778.
- 279 8. *Abigail*. 9. *Asa*.
- 281 6. *SARAH*, b. July 24, 1739, d. in Pepperill, July 24, 1757.
-
67. 282 (IV.) Dea. JONATHAN LAWRENCE, of Littleton; m. (1st), about 1726, TRY-PHENA FLETCHER. She d. Aug. 25, 1752, aged 42. He m. (2d), Oct. 10, 1754, LYDIA FLETCHER, of Groton. He d. Dec. 8, 1789, aged 86 yrs., 1 m. 23 d., and his wid. Lydia d. (in Hollis, N. H.), Mar. 21, 1803, aged 90. His Will, dated Feb. 16, 1784, proved Ap. 20, 1790, mentions wife Lydia; Isaac Lawrence and Martha Stone, heirs of son Jonathan; dr. Tryphena, wife of Jonas Lawrence; sons Abel, Peter, and Timothy; dr. Olive, wife of (?) Ebenezer Fletcher; Lucy, wife of Samuel Clark; Elizabeth, formerly wife of William Stearns (?Stevens); and Abigail, wife of Jasper Dole. Chil.,
- 283 1. JONATHAN, b. Aug. 28, 1728, of Ashby; m., Oct. 31, 1751, MARTHA LEIGHTON. He d. in Ashby, Dec. 2, 1775; (?) admin. granted to son Isaac, Feb. 19, 1782. His wid. d. in Groton, 1795, and dr. Martha was her admin'x. Chil.,
- 284 1. *Martha*, b. May 20, 1752; m., Feb. 13, 1769, *Daniel Stone*, of Groton. Chil.,
- 285 1. *Jeremiah*, b. Jan. 22, 1770. 2. *David*, b. Mar. 23, 1772.
3. *Sewall Corning*, b. May 7, d. Dec. 4, 1774.
- 287 2. *John*, b. Oct. 7, 1754. He is supposed to have been the John L. of Concord on whose estate admin. was granted Oct. 14, 1800, to wid. *Sarah* and son John. The Will of Joshua Lawrence, of Concord (son of John and Sarah), dated Oct. 10, 1799, mentions mother, brothers, and sisters. Agreement of the heirs of John Lawrence, signed in 1800, by Sarah Lawrence (wid.); John Lawrence; Mary and Joseph Buttrick, Jr.; Abigail and Silas Conant, Jr., and the guardian of Thomas Fiske Lawrence and Anne Lawrence, minors. Admin. upon the estate of wid. Sarah Lawrence granted in 1810 to son Thomas Fiske Lawrence.
- 288 3. *Isaac*, b. Oct. 19, 1756; m., 1778, *Anna Hodgman*.
4. *Sarah* (twin), b. Oct. 19, d. Dec. 28, 1756.
5. *Jonathan*, b. 1760, d. in Ashby, Jan. 28, 1778.
- 289 2. ISAAC, b. May 19, 1731, d. Feb. 6, 1756.
- 290 3. ABEL, b. July 16, 1733; of Penobscot, Me.; had a family.
- 291 4. TRYPHENA, b. Sept. 26, 1735; m., Sept. 3, 1754, JONAS LAWRENCE, of Canaan, Conn. [601.]
- 292 5. BETTY (Elizabeth), b. Feb. 24, 1737; m., 1754, WILLIAM (?) STEARNS, of Littleton.
- 293 6. OLIVE, b. May 19, 1740; m. OLIVER FLETCHER, of Groton. 4 chil.
- 294 7. PETER, b. Oct. 17, 1742; of Townsend and of Ashby; m. PERSIS ——. He d. Oct. 21, 1798, and admin. was granted Dec. 25, 1798, to wid. Persis; son Peter her att'y. Chil.,

1. *Persis*, b. and d. May, 1766. 2. *Peter*, b. and d. Feb. 1767.
 295 3. *Peter*, b. May 26, 1768, d. 1826; m., 1794, *Mary Spaulding*.
 296 4. *Betty*, b. Feb. 18, 1770.
 297 5. *Jeremiah*, b. Jan. 29, 1772; m., 1792, *Rachel Wright*.
 298 6. *Isaac*, b. Dec. 7, 1773.
 299 7. *Lavinia*, b. Mar. 31, 1776; m., 1796 or 7, *Elijah Wright*, of Ashby.
 300 8. *Sylva*, b. Mar. 1, 1779.
 301 9. *Asa*, b. July 18, 1781, d. May 25, 1819.
 302 10. *Lydia*, b. Oct. 23, 1783; m., 1804, *Joseph Wheeler*, of Ashby.
 303 11. *Nancy*, b. May 26, 1787; m., 1808, *Timothy Gibson*, of Ashby.
 304 12. *Benjamin*, b. Aug. 26, 1791.
 305 8. ABIGAIL, b. July 26, 1745; m., (?) Sept. 15, 1761, PARKER (? Jasper) DOLE.
 306 9. TIMOTHY, b. Mar. 31, 1748, of Littleton; m., Nov. 30, 1769, SARAH REED, dr. of Col. Jonathan and Sarah (Lawrence) Reed, of Littleton [see J. Lawrence, 228]. She d. in Littleton, Feb. 19, 1792, aged 39. He m. (2d), Dec. 16, 1793, MOLLY BOYDEN, of Groton, who d. in Hollis, N. H., Sept. 3, 1842, æt. 84. He d. in Hollis, Nov. 3, 1815, aged 67.
 307 1. *Thaddeus*, b. Nov. 17, 1771, of Ashby and Cohasset; m., 1796, *Joa Oakes*, b. in Cohasset, Mar. 1, 1774. He was one of the original members of the second Cong. Church in Cohasset, gathered at his house, of which he was soon elected a deacon. Chil.,
 308 1. *Josiah Oakes*, b. May 1, 1797, d. Sept. 15, 1802.
 2. *Maria*, b. Dec. 15, 1798; m., Dec. 1819, *Thomas Smith*, of Rowley, now (1848), of Cohasset. 10 children.
 3. *Thomas Reed*, b. Aug. 20, 1800, d. Aug. 16, 1811.
 309 4. *George Augustus*, b. Jan. 7, 1802; of Cohasset; m., Jan. 8, 1826, *Caroline Vinal*, of Scituate. Chil.,
 310 1. *Thomas Reed*, b. Dec. 17, 1826.
 311 2. *Rebecca Merritt*, b. Aug. 15, 1828; m., Aug. 10, 1845, *Daniel Hollis*, of Cohasset, formerly of Hollis, N. H.
 3. *Evelina*, b. in Medford, Aug. 14, 1831, d. Feb. 29, 1836.
 312 4. *George Augustus*, b. in Quincy, Aug. 11, 1834.
 313 5. *Evelina*, b. Ap. 27, 1837. 6. *Sophronia Oakes*, b. Ap. 4, 1840.
 315 7. *Fordyce Foster*, b. May 9, 1843.
 316 5. *Joa*, b. 13, d. 16 Oct., 1803.
 317 6. *Josiah Oakes*, b. May 6, 1805, of Cohasset; Rep. 1844; m. (1st), Nov. 12, 1826, *Hannah Kent Tower*, b. May 8, 1806. She d. Dec. 14, 1843. He m. (2d), May 6, 1848, *Sarah Jane Doane*, of Cohasset, b. Mar. 30, 1820. Chil.,
 1. *Tower*, b. Aug. 21, 1827, d. Oct. 6, 1828.
 2. *Maria Smith*, b. Dec. 23, 1828. 3. *George W.*, b. Feb. 29, 1832.
 4. *Ellen A.*, b. Sept. 6, 1834, d. Ap. 21, 1838.
 5. *Lyman*, b. Sept. 2, 1837, d. May 3, 1838.
 6. *Lyman*, b. June 16, 1839.
 7. *William Edward*, b. Mar. 31, d. May 17, 1842.
 8. *Hannah Tower*, b. June 16, 1843.
 318 7. *Mary Oakes*, b. May 1, 1807; m. Nov. 15, 1832, *John Parker*, of Cohasset, son of Dea. *Jonas Parker*, of Pepperill. 10 chil.
 319 8. *Hannah*, b. July 31, 1809; m., about 1830, *Hiram Bruce*, of Brighton.
 320 9. *Sophronia Mann*, b. Jan. 15, 1813, d. Nov. 2, 1839. A memoir of her, by Rev. M. Moore, has been published.
 321 2. *Dortas*, b. Ap. 17, 1774; m., 1801, *Solomon Fletcher*; is now a wid, living (1848), with a son, *Solomon Fletcher*, in Woburn.
 322 3. *Benjamin*, b. Mar. 11, 1776, d. Sept. 24, 1778.
 4. *Mary*, b. Oct. 16, 1778. 5. *Jonathan*, b. Mar. 10, 1781.
 324 6. *Elizabeth Lane*, b. Feb. 14, 1784; m., 1802, *C. Wood*, of Littleton.
 325 7. *Isaac*, b. Aug. 25, 1786; was killed in the battle of Queenstown.
 326 8. *Nathan*, b. Ap. 23, 1789; of Hollis, N. H.; m. about 1812.
 327 9. *Sarah*, b. Aug. 3, 1790. 10. *Tryphena*, b. Feb. 11, 1792.
 (By 2d wife, Molly.)
 328 11. *Lydia*, b. Nov. 9, 1794. 12. *Molly*, b. Feb. 26, 1796.
 329 13. *Anna*, b. Nov. 20, 1797. 14. *Samuel Boyden*, b. Mar. 24, 1799.
 330 10. *Lucy*, b. May 15, 1750; m. SAMUEL CLARKE, of Lincoln.

- 331 11. BENJAMIN, b. Aug. 2, 1752.
-
69. 332 (IV.) ELEAZER LAWRENCE (? of Littleton), m., June 25, 1731, LUCY TUTTLE.
- 333 1. LUCY, b. Feb. 29, 1731-2; m., Feb. 20, 1755, THOMAS CUMMINGS.
2. PETER, b. Feb. 20, 1732-3, d. Sept. 27, 1735.
- 334 3. ELEAZER, b. Aug. 11, 1735. [Perhaps he was the Eleazer Lawrence of Westford, whose Inventory was dated Sept. 1, 1788, and admin. granted to wid. Sarah in 1790. Had a dr. Sarah under 7 years.] Eleazer Lawrence adm. f. c. E. Sud., Ap. 1, 1759.
- 335 4. JOSIAH (twin), b. Aug. 11, d. Sept. 27, 1735.
5. MARY, b. July 27, 1737; m., Jan. 21, 1762, JONATHAN FLETCHER (? son of Joseph and Elizabeth, of Groton).
- 336 6. SIMON, b. Jan. 11, 1739; m., 1769, SYBIL ROBBINS. He settled in Westford. He d. 1795. His estate settled in 1797; wid. LUCY; chil. *Lucy, Lydia, Sarah, Lucinda, Susanna*, and *Oliver*, under 14. *Zachariah* and *Elizabeth*, above 14 yrs. Simon, eldest son.
- 337 7. SUSANNA, b. Nov. 3, 1740; m., Oct. 15, 1761, ISAAC SPAULDING.
- 338 8. DAVID, b. Jan. 26, 1742. His estate was admin. Nov. 6, 1790, by his wid. HANNAH, and son, Dea. — Lawrence, Esq., who d. in Littleton in 1827.
9. SARAH, b. Jan. 4, 1745, d. Mar. 28, 1753.
10 and 11. Twin sons, b. and d. Jan. 1, 1747.
-
72. 339 (IV.) SAMUEL LAWRENCE, of Littleton, m., May 6, 1737, MARY HILDRETH, of Westford. She d. in Littleton, Mar. 17, 1788, aged 70, and he soon after went to Ashby, where he died. His Inventory, £188 13s. 6d., dated June 26, 1789, presented by his son Samuel.
- 340 1. SAMUEL, b. Jan. 24, 1738; m. (1st) REBECCA —, by whom he had 7 chil., b. in Groton. He m. (2d), SUSANNA —. He d. in Ashby, leaving wid. Susanna, and admin. was granted to his eldest son, Jabez, Aug. 9, 1799.
- 341 1. *Rebekah*, b. in Groton, Mar. 2, 1763. 2. *Hannah*, b. Dec. 26, 1765.
- 343 3. *Jabez*, b. Mar. 19, 1767, appointed, in 1817, guardian of his own sons, Jabez and Gilman, over 14 years old; the gr. chil. of Asa Kendall.
- 344 4. *Samuel*, b. Feb. 23, 1769.
- 345 5. *Oliver*, b. Aug. 17, 1770. 6. *Bridget*, b. May 3, 1774.
- 347 7. *Abijah*, b. July 6, 1777.
- 348 2. JOSEPH, b. Sept. 6, 1739, of Littleton; m., and had children.
- 349 3. CHARLES, b. Jan. 20, 1741, of Littleton; m., about 1762, NAOMI —. She d. June 2, 1805, aged 62 years, and he d. May 22, 1825, aged 84 yrs. 4 mos.
- 350 1. *Sarah*, b. Feb. 29, 1764. 2. *Levi*, b. Jan. 8, 1767, d. Mar. 27, 1787.
- 351 3. *Reuben*, b. Jan. 27, 1768, d. 1844; m., 1794 or 5, *Lois Tenney*.
- 352 4. *Alethon*, b. Oct. 15, 1771; of Ashby; d. June 6, 1842; m., 1797, *Polly Tenney*, of Littleton. Chil.,
1. *Polly*, b. Feb. 15, 1798, d. Mar. 1800. 2. *Sarah*, b. Ap. 18, 1800.
3. *Mary*, b. May 3, 1801. 4. *Betsy*, b. May 10, 1804.
5. *Leonard*, b. Feb. 17, d. July 29, 1806.
6. *Zoa*, b. and d. June, 1808.
7. *Nancy*, b. June 17, 1809. 8. *Charles*, b. Mar. 29, 180—.
- 353 5. *Jonas*, b. Oct. 28, 1773, d. Ap. 8, 1774. 6. *Polly*, b. Mar. 16, 1778.
- 354 7. *Stephen*, b. May 28, 1780; m., 1803, *Sally Maynard*.
- 355 8. *Amos*, b. Oct. 12, 1781; m. (?) 1804, *Lydia Skattuck*.
- 356 4. MARY, unm., went to Ashby with her father.
-
128. 357 (IV.) ENOCH LAWRENCE, of the West Precinct of Groton (Pepperill); m., Jan. 29, 1733-4, SARAH STEVENS [in one record written Stearns]. He and wife were dismissed from Pepperill Church to Mason, N. H., in 1772. Chil.,
- 358 1. SAMUEL, b. Sept. 12, 1734. 2. RICHARD, b. July 15, 1736.
- 360 3. ENOCH, b. July 24, 1738; m., in Groton, Dec. 21, 1762, ESTHER WOODS (?), b. June 12, 1736, dr. of Amos and Hannah (Nutting) Woods.
- 361 4. SARAH, b. Aug. 6, 1740. 5. LYDIA, b. July 16, 1742.
- 363 6. STEPHEN, b. Mar. 23, 1744. 7. DANIEL, b. Mar. 28, 1746, d. Oct. 2, 1751.
- 364 8. Lois (twin), b. Mar. 28, 1746. 9. HANNAH, b. Ap. 12, 1748.

169. 366 (IV.) Capt. ISAAC LAWRENCE, m. (1st) LYDIA HEWITT, who d. Nov. 14, 1767, aged 60. He m. (2d) wid. AMY WHITNEY, s. p. He d. Dec. 2, 1793, aged 88 yrs. 9 m. and 23 d.; and his wid. survived him 26 years. "In the spring of 1738, with a team composed of a yoke of oxen and a horse, he started, with his family and goods in a cart, for his new home, in what was then called the New or Western country," and he reached Canaan, the place of his destination, June 2, 1738. The last 30 miles of the journey was through a heavily wooded forest, without house, or road, or bridge, over streams too deep to be forded. It is said that nine days, some say fourteen days, were occupied in making this part of the journey, from New Hartford to Canaan. He first encamped under an oak tree, and soon after made a temporary shelter in the side of a hill, half under ground, in which he lived until the next spring, when he built a house on the lot opposite to the saw-mill. A few years afterwards, he built a second house, and in 1751, he built the house which has been long known as the Lawrence Tavern, and which he occupied until about 1786, when he relinquished the care of it to his son Jonas, with whom he lived until his decease. His stature was six feet, and erect, frame large, but not fleshy; was intelligent and sociable, with a pleasant countenance. In business, he was active and correct, and his character unblemished. By occupation he was a farmer, but, having a good deal of mechanical ingenuity, he used to do some work for himself, and neighbors, as a carpenter and joiner, and is said to have superintended the erection of the first meeting-house in Canaan.
- "He accumulated a valuable property, owned several large farms, which he kept under cultivation; was the owner of twenty slaves at one time, to whom he gave their freedom before his death, with the exception of one, who was liberated by his heirs, making provision for the aged and infirm, and contributing to the comfort of others who were needy." He held many town offices, and was Representative to the General Assembly, in 1765. He was at first a member of the Cong. Church, now in South Canaan. In 1769, he and his wife were dismissed to the church in North Canaan. [For more particulars respecting his migration, his settlement, and his public services, see Genealogy of the Ancestry and Posterity of Isaac Lawrence, pp. 10-13.] Chil.,
601. 367 1. JONAS, b. 1728.
 776. 368 2. AZUBAH, m., Oct. 25, 1750, SAMUEL HYDE, of Norwich, Conn.
 3. STEPHEN, d. in infancy.
 369 4. ISAAC, m., Mar. 18, 1760, MARY BROWN [Brown, 75]. About 1783, he moved from Canaan, Conn., to Canaan, Vt. Chil.,
 370 1. Lydia, b. Sept. 2, 1761.
 371 2. Elijah, b. Oct. 17, 1763, settled in Canada East.
 372 3. Samuel, b. Nov. 19, 1765, settled in C. E.
 373 4. Isaac, b. Nov. 22, 1767; m. Debby Root, and settled in C. E.
 374 5. Mary, b. May 4, 1770. 6. Apame, b. Dec. 7, 1772.
 376 7. Henry, b. Feb. 25, 1778. 8. Erastus, b. Mar. 11, 1780.
 378 9. Pamela, b. May 17, 1782.
 5. ASA, d. July 24, 1750. 6. WILLIAM, d. Jan. 5, 1750.
 807. 379 7. AMY, m., Mar. 30, 1760, ELIJAH COBB.
 8. SOLOMON, d. July 21, 1750. 9. LYDIA, b. Dec. 2, 1747; d. Aug. 4, 1750.
 10. ELIJAH, d. young.
 868. 380 11. HANNAH, b. May 25, 1750; m. WILLARD KINGSBURY.
217. 381 (V.) THOMAS LAWRENCE, of Groton, m., in Groton, July 3, 1744, SARAH HOUGHTON. He d. (?) in Pepperill, 1758. His wid. Sarah, and children, were warned out of Pepperill, in 1760, which implies that they had recently gone there. [? Thomas Lawrence m., in Groton, May 5, 1757, Sarah Bailey.]
- 381½ 1. EDMUND, b. Ap. 14, 1745. The tradition is, that, when a young man, he drove a team for a man, who was transporting goods in order to commence trade in Winchester, N. H.; that on his way he became enamoured with BERTHEZZA BUTTERFIELD, the dr. of an innkeeper, married her, and settled in Winchester. We have the names of only two of his children, viz.,
 890. 382 1. Edmund, b. Feb. 23, 1772.
 382½ 2. Nathaniel, m. Molly Buttrick, and moved to Marlboro, Vt., where he d. 1814, aged about 43.

- 383 2. SARAH, b. Feb. 20, 1747; m., in Pepperill, Jan. 21, 1772, ABIJAH PARKER. Chil.,
 1. Sarah, b. Sept. 13, 1772. 2. Abijah, b. Aug. 7, 1774.
 3. Elizabeth, b. Oct. 14, 1776. 4. Mary, b. Sept. 24, 1779.
 5. Phinehas, b. Mar. 12, 1782. 6. Martha, b. June 29, 1784.
 7. Edmund Lawrence, b. Feb. 26, 1787; d. May 6, 1788.
 8. Edmund, b. June 4, 1790; d. Feb. 7, 1792.
- 384 3. ALICE, b. Sept. 13, 1749. 4. MARIA, b. Ap. 5, 1752.
- 386 5. THOMAS, b. Dec. 25, 1757; a Major, of Pepperill, received a wound in the
 Battle of Bunker Hill. He m., Aug. 10, 1779, ANNA SHATTUCK. He d. July
 28, 1822. Chil.,
 1. Anna, b. Jan. 23, 1781; d. May 5, 1788.
- 387 2. Thomas Stimpson, b. Dec. 30, 1782; m. Rebecca Dorrell. Chil.,
 1. Walter, of Rhode Island. 2. William T., of Pep., m. Betsey Fitch.
- 388 3. Edmund, b. June 25, 1785; m. Lydia Green; 3 sons, of whom Thomas G.,
 and Alden, are married, also drs. married.
 4. Betty, b. Ap. 7, 1788; d. Feb. 8, 1792.
- 389 5. John, b. Dec., 1791; m., 1818, Sally Ames, of Pepperill.
- 390 6. Mary, b. Mar. 6, 1794; m. Eliphalet Parker. 5 children.
- 391 7. Anna (Nancy), b. June 13, 1796. 8. Charles, b. Feb. 7, 1799.
- 393 9. Luther, b. Nov. 7, 1801; m., about 1827, Thirza Spaulding. Chil.,
 1. Luther. 2. Charles. 3. Thirza. 4. Mary. 5. Jane. 6. Sarah C.
 7. Jane L.
- 394 10. Royal, b. Mar., 1804; of Leominster; m. Almira Norcross. 6 chil.
-
218. 395 (V.) JONATHAN LAWRENCE, of Groton, m. ESTHER —. He is said to
 have been a large landholder. He d. Ap. 12, 1806, aged 81.
- 396 1. MARY, b. Jan. 2, 1744; m., May 20, 1772, Lieut. SAMUEL TUTTLE, of Littleton;
 d. in Tyngsboro, Nov. 6, 1826.
- 397 2. ESTHER, b. Dec. 15, 1746; m., in Groton, Oct. 29, 1767, JOHN PAGE; d. in
 Rindge, N. H., Feb. 18, 1817.
- 398 3. PRUDENCE, b. Nov. 30, 1748; m., Jan. 19, 1764, JOHN GILSON, Jr., his 2d wife.
 2 children.
- 399 4. SARAH, b. May 30, 1751; m., July 14, 1774, ABEL BANCROFT, son of Dea. Ben-
 jamin, Jr., and Alice, of Groton. [52, p. 283.]
- 400 5. JONATHAN, b. Oct. 15, 1753; d. in Charlestown, N. H.
- 401 6. THOMAS, b. 15, d. 24, Jan. 1756. 7. ANNA, b. Jan. 18, 1757.
- 403 8. LEVI, b. Aug. 14, 1759; (?) m., in Pepperill, June 12, 1781, ELIZABETH HOLDEN.
 He d. in Thetford, Vt.
9. ABIGAIL, b. June 13, d. Dec. 3, 1761.
- 404 10. WILLIAM, b. Dec. 4, 1762; d. in Washington, N. H.
- 405 11. ASA, b. Mar. 13, 1765; of Groton; m. LYDIA FARNSWORTH. He d. Feb. 7,
 1826. Chil.,
 406 1. Francis, b. July 5, 1792; (?) a warden of the Penitentiary, in Charlestown;
 left a widow, of Pepperill.
- 407 2. Harriet, b. Jan. 26, 1798; m. James Stone, of Groton.
- 408 3. Asa Farnsworth, b. Feb. 7, 1799; grad. Harv. Coll., 1824; of Pepperill;
 m. Sarah Jane, dr. of Dr. Amos Bancroft, of Groton. He is a lawyer, and
 has been a State Senator. Chil.,
 1. Mary Helen, b. June 28, 1839.
 2. Elizabeth Bigelow, b. Mar. 9, 1841.
 3. Sarah Frances, b. Mar. 8, 1844.
- 409 12. JOEL, b. July 21, 1767; of Groton; m. (1st), Dec. 22, 1790, RUTH COLLIER.
 She d. Nov. 10, 1801, aged 35. He m., Jan., 1803, a 2d wife, who d. Nov.,
 1817, s. p. He m. (3d), 1819, Mrs. RUTH WILLARD. He d. May 26, 1827, aged
 60. Chil.,
 410 1. Thomas, b. Mar. 30, 1792, d. young.
- 411 2. Susan, b. Feb. 28, 1794; d. Aug. 26, 1830.
- 412 3. Lucy, b. Sept. 16, 1796; d. Dec. 12, 1845.
- 413 4. Curtis, b. Ap. 26, 1799; a deacon, of Groton; m. (1st), May 6, 1822, Lucy
 Merriam, of Mason, N. H., b. Ap. 24, 1800. She d. Nov. 18, 1846, and he
 m (2d), July 1, 1847, Mrs. Mary Ann B. Davis, of New Ipswich, N. H. Chil.,
 1. Edward Addison, b. Feb. 25, 1823; grad. Dart. Coll., 1845.

- 414 2. Lucy Maria, b. Mar. 8, 1825; m., July 11, 1847, Rev. William Wood, a missionary of the A. B. C. Foreign Missions, at Bombay.
- 415 3. Mary Wheeler, b. Ap. 15, 1827. 4. Susan Frances, b. Nov. 30, 1828.
- 417 5. Eliza, b. Sept. 28, 1801; m., about 1825, Nathaniel Baynton, of Mason, N. H. They have children, and have lived in Shirley.
(By 3d wife.)
- 418 6. William, b. Aug. 26, 1820.
-
220. 419 (V.) Rev. WILLIAM LAWRENCE, grad. Harv. Coll., 1743, ordained in Lincoln, Dec. 7, 1748, where he d. Ap. 11, 1786. During his ministry 122 were adm. f. c.; 605 baptisms; 122 marriages; 294 deaths. His epitaph: "In Memory of Rev. William Lawrence, A.M., Pastor of the Church of Christ, in Lincoln, who died Ap. 11, 1780, in the 57th year of his age, and 32d of his Ministry. He was a gentleman of good abilities, both natural and acquired, a judicious divine, a faithful minister, and firm supporter of the order of the churches. 'Be thou faithful unto death, and I will give thee a crown of life.'" His Will, dated Mar. 22, proved May 10, 1780.
- He m., Feb. 7, 1750-1, LOVE, only dr. of John and Love Adams, of Lincoln, b. June 23, 1725. She d. Jan. 3, 1820, æt. 95. [See Geneal. Reg. I., 177 and 261.] Chil.,
- 420 1. WILLIAM, b. Ap. 10, 1752; a Lieut., of Lincoln; m., Nov., 1780, EUNICE BROWN, dr. of Capt. Nathan and Rebecca (Adams) Brown, of Lincoln. [See Geneal. Reg. I., p. 260.] He d. Dec. 2, 1804, insolvent; wid. Eunice, admin'x. She d. Oct. 2, 1807. Chil.,
- 421 1. Love Adams, b. Jan. 6, 1782; m., Ap. 17, 1804, Thomas Swan, d. in Lancaster, Mass.
- 424 2. William, b. Jan. 29, 1784; m. Abigail Flint, of Concord; d. in Philadelphia; son William, living in New York.
- 425 3. Betsey, b. Dec. 1, 1785; m. Samuel S. Green, of East Camb.
- 426 4. Daniel, b. Ap. 1, 1787; d. Sept. 18, 1827; m., 1809, Sally More, of Sud.; 2 sons, and one dr., son Daniel J., of Concord.
- 427 5. Nathan Brown, b. Ap. 28, 1789; of Boston, unm.
- 428 6. Abel, b. Ap. 6, 1791; of Lincoln; m. Nancy ——. She d. Feb. 10, 1838, and he d. Feb. 20, 1843.
1. Abel, b. June 7, 1820. 2. Eunice Brown, b. July 10, 1822.
3. Alice Henrietta, b. Dec. 26, 1826. 4. George, b. May 22, 1828.
5. Grosvenor Prescott, b. Sept. 10, 1830. 6. Andrew, b. Sept. 18, 1834, d. 1846.
7. John, b. July 14, 1793; d. July 28, 1808.
- 429 8. Eunice, b. Sept. 14, 1795; m. Solomon White, of Randolph.
- 430 9. Marry, b. Nov. 20, 1797; m., 1819, Heman Ray. 9 chil.
- 431 10. Susanna, b. Sept. 16, 1800; d. in Providence, about 1817.
- 432 2. LOVE, b. Ap. 18, 1754; m., Sept. 4, 1770, Dr. JOSEPH ADAMS. She probably d. soon, as Dr. Joseph and Mrs. ELIZABETH ADAMS, had dr. Lovey, b. Sept. 30, 1775, and d. June 10, 1776. He d. in Eng., Feb. 2, 1807. [See Geneal. Reg. I., pp. 260 and 261.]
- 433 3. JOHN PRESCOTT, b. Dec. 24, 1755; a physician; m., 1786, ABBY KAINE, settled at Fort Edward, N. Y., and d. Jan. 28, 1808. Chil.
- 434 4. SUSANNA, b. Jan. 4, 1758; d. Mar. 12, 1836; (?) m. Lieut. EDE, and had chil.
- 435 5. SARAH, b. May 12, 1760; d. Oct. 12, 1822; m., Oct. 30, 1783, SAMUEL BASS, Esq., of Braintree; grad. Harv. Coll., 1782; d. Feb. 1, 1842, aged 85. 7 chil.
- 436 6. PHEBE, b. Sept. 2, 1762; d. 1812; m., Oct. 30, 1783, Rev. EDMUND FOSTER, of Littleton, b. in Redding, 1752; grad. Yale Coll., 1778; d. 1826, after a ministry of 47 years. They had children.
- 437 7. ANNA, b. Mar. 25, 1764; d. Dec. 8, 1807; m. JAMES DE WOLF, of N. Scotia.
- 438 8. MARY, b. Nov. 1, 1767; d. Sept., 1812; m. ASA BROOKS, of Concord.
- 439 9. ABEL, b. Aug. 23, 1771; m. MARY HODGE, of St. Germain, Eng., and d. Sept. 1, 1810, leaving 6 chil., one of whom is a druggist in Liscard, Eng.
-
223. 440 (V.) ABEL LAWRENCE, Esq., of Groton, m., Nov. 14, 1750, MARY BULKLEY, b. in Concord, Jan. 9, 1727, d. in Groton, Aug. 22, 1801, dr. of John Bulkley, Esq., of Groton, b. 1703; granddr. of Joseph Bulkley; gr. grandr. of Peter Bulkley, and

gr. gr. grandr. of Rev. Peter Bulkley, of Concord [see Shattuck, p. 366]. He d. Sept. 20, 1770, aged 41. Inventory dated Dec. 6, 1771. [Sept. 17, 1783, estate of Abel Lawrence, of Groton, declared insolvent, and Moses Child appointed adm'r, and Jonathan Lawrence, security. He held undivided land with Samuel Tarball. A further division, made in 1793, of £58 14s., received of Sarah Child, ex'x of the adm'r of Moses Child, of Temple, by her att'y, Elisha Child, was accepted for by Samuel Lawrence.]

1. ABEL, b. Oct. 14, 1752, d. July 14, 1753.
- 441 2. JOHN (twin), b. Oct. 14, 1752, drowned June 5, 1771.
- 442 3. ABEL, b. July 31, 1754; of Salem; m., Aug. 5, 1780, ABIGAIL PAGE, dr. of Daniel and Abigail (Johnson) P., of G. She d. Jan. 14, 1839, aged 80 yrs. 11 months. "Her end was peace; she fell asleep in Jesus." He d. Dec. 4, 1822, "beloved and honored by all who knew him. His children's richest inheritance is their father's good name. He trusted in Jesus." Chil.,
- 443 1. Polly, b. May 5, 1782, d. Oct. 14, 1785.
- 444 2. Abigail Page, b. Sept. 29, 1783.
- 444 3. John Bulkley, b. Dec. 23, 1784, d. in Salem, Sept. 8, 1831. "He was an eminent Christian, and died in the faith."
- 445 4. Abel, b. Sept. 6, 1786; of Salem; m., Feb. 4, 1816, Caroline Wallace, of Milford, N. H. She d. Oct. 19, 1828, aged 31 yrs. Chil.,
- 446 1. Mary Wallace, b. May 18, 1817.
- 447 2. Caroline Wallace, b. Feb. 6, 1819.
- 448 3. Elizabeth, b. June 16, d. June 26, 1822.
- 448 4. Elizabeth Clarke, b. Sept. 9, 1823.
5. Susan Cornelius, b. Sept. 29, 1827, d. Dec. 20, 1828.
5. Mary, b. May 23, 1788, d. Oct. 7, 1795.
6. Henry, b. Dec. 14, 1789, d. Aug. 13, 1798.
- 449 7. Elizabeth Clark, b. Aug. 15, 1791.
- 450 8. Harriet, b. July 4, 1793; m., Ap. 18, 1819, Abel Lawrence Pierson, grad. Harv. Coll. 1812; M.D. 1816; M.M.S.S. et A.A.S., of Salem. He d. (killed by the catastrophe on New Haven R. R. at Norwalk) May 5, 1853. 8 chil.
- 451 9. Charles, b. Oct. 7, 1795; of North Danvers; grad. Harv. Coll. 1815; m., about 1833, Lucy A. Ward, of Boston.
- 452 10. Mary Morris, b. Ap. 28, 1798.
- 453 11. Jane, b. Dec. 24, 1799; m., Oct. 27, 1823, Benjamin Perkins, of Boston. 7 chil.
12. Henry Page, b. July 24, d. in Danvers, Nov. 11, 1803.
- 454 13. Sarah Susanna, b. Mar. 13, 1805, d. July 2, 1835; m., May 5, 1834, George W. Endicott, a descendant of Gov. John Endicott, of Salem.
- 456 4. MARY, b. July 12, 1757, d. Sept. 1787, aged 30 yrs.
-
229. 457 (V.) JONATHAN LAWRENCE, of Woburn, afterwards Ashby, m., Dec. 13, 1757, ELIZABETH JOHNSON, of Woburn. She d. in Ashby, Dec. 26, 1782, aged 46, and he m. a 2d wife. He d. Nov. 26, 1799, aged 65. His Will, dated Sept. 20, 1797, proved Ap. 15, 1800, mentions wife (not named); sons Benjamin, Jonathan, and William; dr. Elizabeth [wife of Joseph] Wheeler; dr. Dorcas [wife of John Earl] Stone; dr. Rusha [wife of Bartholomew] Ballard.
- 458 1. JONATHAN, b. Dec. 11, 1758, d. in Ashby, 1806, aged 47. His estate was distributed in 1807 to wid. LYDIA, and the following children: 1. Lucy, wife of Avery Prescott; 2. Betsey, wife of David Pierce; 3. Lydia; 4. Jonathan; 5. Olive, 6. Jerusha, minors.
- 459 2. ELIZABETH, b. Ap. 26, 1761; m., 1779, JOSEPH WHEELER.
- 460 3. BENJAMIN, b. May 23, 1764; of Ashby; m. (1st), about 1794, PERSIS ——. He m. (2d), in 1807, POLLY TOWNSEND. She d. Nov. 5, 1819, and he d. Sept. 4, 1842, aged 78. Chil.,
- 461 1. Otis, b. June 22, 1795, d. Feb. 2, 1796. 2. Horace, b. Mar. 10, 1797.
- 462 3. Micah, b. Jan. 18, 1799. 4. Clarissa, b. July 24, 1802.
- 464 5. Benjamin Dennison, b. July 15, 1804.
(By 2d wife, Polly.)
- 465 6. Persis Coleman, b. Oct. 9, 1808. 7. William Johnson, b. May 30, 1811.
8. John, b. Aug. 3, 1814. 9. Otis, b. Nov. 26, 1815.

- 469 4. DORCAS, b. Sept. 17, 1766; m., 1790, JOHN EARL STONE, of Ashby.
- 470 5. MICAH, b. Aug. 22, 1769, of Ashby; not mentioned in his father's Will; m., Jan. 11, 1796, HANNAH BUNKER, of Charlestown.
- 471 6. WILLIAM JOHNSON, b. Jan. 1, 1773; a Dea., of Ashburnham; d. 1844.
- 478 7. RUSRA, b. May 23, 1775; m., 1796, BARTHOLOMEW BALLARD.
-
230. 479 (V.) BEZALEEL LAWRENCE, of Lex., m. Oct. 19, 1758, SARAH MUZZY, (?) b. Mar. 30, 1737, dr. of Amos and Esther (Green) Muzzy, of Lexington. He d. Feb. 6, 1797, aged 61, and his wid. Sarah d. Feb. 4, 1819, aged 81. His estate was distributed Ap. 28, 1798, to wid. Sarah, and chil. Bezaleel, Jonathan, Anna, and Bethia.
-
- 480 1. SARAH, b. Sept. 3, 1759; m., Nov. 15, 1781, JOHN SMITH, of Lex. [? Smith, 62-2.]
- 481 2. ANNA, b. May 17, 1761, d. Ap. 4, 1845, aged 86, unm.
- 482 3. BEZALEEL, b. Ap. 12, 1763 (?) of Leominster.
- 483 4. ESTHER, b. June 30, 1765; m., 1784, JOHN HASTINGS. [64, p. 790.]
- 484 5. BETHIA, b. Sept. 25, 1767, d. Ap. 19, 1801, aged 34. Her Will, dated Feb. 12, 1798, proved Ap. 13, 1802, gave her estate to her sister Anna.
- 485 6. JONAS, b. Feb. 27, 1770; of Lex.; m., Ap. 23, 1789, DORCAS WOODS, of Woburn. He d. (?) in Lex., 1835. Chil.,
- 486 1. Dorcas, b. Oct. 29, 1790. 2. Edmund, b. Dec. 7, 1794.
- 488 3. Jonas, b. Feb. 4, 1796. 4. Surena, b. July 19, 1798.
- 490 5. Lucy, b. Jan. 12, 1801. 6. John, b. June 17, 1803.
- 492 7. Emeline, b. Dec. 7, 1805. 8. Joseph Bradley Varnum, b. Aug. 31, 1806.
- 494 7. JONATHAN, b. Sept. 11, 1774; of Lex., where he d. about 1840. He m., Ap. 12, 1798, POLLY REED, of Bedford. Chil.,
- 495 1. Polly, b. Ap. 28, 1799. 2. Esther, b. Ap. 23, 1801.
- 497 3. Abigail, b. Nov. 8, 1803, d. Dec. 23, 1826.
4. Elizabeth Swain, b. Sept. 10, 1807.
-
231. 498 (V.) Rev. MICAH LAWRENCE, grad. Harv. Coll. 1759, some time a teacher in Worcester; ordained in Winchester, N. H., Nov. 4, 1764, as successor of Rev. Joseph Ashley, the first minister, afterwards of Sunderland. [Rev. Joseph Ashley grad. Yale Coll. 1730; ordained in Winchester 1736. The people were dispersed by an irruption upon the settlement. The church was regathered at the settlement of Mr. Lawrence. Mr. Ashley d. 1797.] "His style of writing was characterized by method, clearness, closeness, and strength. In doctrine Scriptural and sound, in order and discipline careful and unyielding, his constant reference was to the law and the testimony. Highly conservative in spirit, and loyal beyond most of that day, his political sentiments became the occasion of disaffection among a portion of the people," and, after a third council, he was dismissed, on the ground that he was "unfriendly to the war." After 1777 he preached in other places, and d. in Keene, N. H., Oct. 20, 1798, aged 60. *Keene, N. H., Oct. 20, 1798*
- He m., 1765, EUNICE WILLARD, b. Mar. 1745; dr. of Col. Josiah Willard, of Winchester, N. H., a descendant of Major Simon Willard, of Concord. She d. in Keene, Oct. 20, 1788, æt. 44. [See 22, p. 797.] Chil.,
- 499 1. EUNICE, b. July 22, 1767; m. twice; now (1848), living with her son, Solomon Ware, at Niagara Falls.
- 500 2. ZULIMA, b. May 26, 1769, d. 1805; m. — FAIRFIELD, and had children.
- 501 3. ABIGAIL, b. May 5, 1771; m. — ROOT, and d. in Pittsfield, Mass.
- 502 4. HUBBARD, b. Mar. 7, 1773. In 1800, he moved to St. Johnsbury, Vt., where he was actively engaged in organizing the first church gathered there, of which he was elected a deacon. He possessed "warm, generous feeling, good sense, and sound judgment," "was deeply interested in the improvement of society, and did much for its advancement," was a good example of a husband, a parent, a citizen, and a Christian. He m., Feb. 22, 1801, MARY Goss, b. June 11, 1780, dr. of Major Philip Goss, of Winchester, N. H., a descendant of the third generation of Philip Goss, b. in Concord, Mass., a captain in the French war, who d. at Cape Breton. Dea. H. Lawrence d. Sept. 20, 1816, aged 43, and his wid. m., Jan. 14, 1823, Selah Pomroy, Esq., of Stanstead, C. E., where she d. Ap. 1, 1837, assured of the blessing of those "who die in the Lord."
- 503 1. Louisa, b. Jan. 4, 1802; m., Sept. 4, 1827, Zelotes Hosmer, merchant, of Boston,

- residing in Camb. Chil., 1. Samuel D. 2. James. 3. Mary (twins). 4. Henry Zelotes.
- 504 2. *Clarissa Goss*, b. July 31, 1803; m., Nov. 30, 1830, Rev. *Lucius Doolittle*, an Episcopal clergyman, in Canada E.
- 505 3. *Mary Ann*, b. May 29, 1805; m., June 1, 1831, *Ashley P. Graves*, late of Leroy, N. Y. 2 sons and 2 drs.
- 506 4. *Solomon Willard*, b. Feb. 3, 1807, d. Mar. 3, 1820.
- 506 5. *Edward Alexander*, b. Oct. 7, 1808; grad. Dart. Coll. 1834; studied at And. Theol. Seminary, and was ordained in Haverhill, May, 1839. In Ap. 1845, he was settled in Marblehead. He m., May 20, 1839, *Margarette*, dr. of Rev. Leonard Woods, D.D., of Andover. Chil.,
1. *Margarette Louisa*, b. in Haverhill, July 18, 1842.
2. *Caroline Matilda*, b. in Haverhill, Nov. 14, 1844.
3. *Edward Alexander*, b. in Marblehead, Jan. 16, 1847.
- 507 6. *Emily*, b. May 7, 1810; m., Feb. 1836, *Ebenezer Graves*, late of Springfield.
- 508 7. *Hubbard*, b. May 1, 1812; entered Dart. Coll. in 1834, left in 1836; afterwards grad. at Marietta College; studied theology at Lane Seminary, and settled, a minister, in Brunswicke, O. He m., Sept. 28, 1841, *Martha Sawyer*, of Cambridge. Chil.,
1. *Martha*, b. Sept. 11, 1842. 2. *Mary*, b. Sept. 22, 1844.
3. *Hubbard*, b. May 20, 1846.
- 509 8. *John*, b. May 21, 1814; a minister of Carlisle, Mass.
9. *William Goss*, b. Aug. 3, 1816, d. Ap. 19, 1817.
-
233. 510 (V.) JOHN LAWRENCE, a Deacon, of Ashby, m., 1771, BETTY PERRY, of Provincetown. He d. Mar. 15, 1817, aged 68, and his wid. d. June 8, 1836, aged 91.
-
1. ARTEMAS, b. Mar. 22, 1773, d. Sept. 27, 1775.
- 511 2. LUCINDA, b. May 17, 1775; m. BARTHOLOMEW BALLARD.
- 512 3. ARTEMAS, b. Ap. 6, 1777, of Ashby.
- 513 4. ZULIMA, b. Ap. 25, 1779, d. 1815; m., 1802, STEPHEN PATCH.
- 514 5. BETSEY, b. Ap. 30, 1781, d. 1840; m (1st), ALLER FARWELL; and m. (2d), Dea. H. RICHARDSON, of Mason, N. H.
- 515 6. ZOA, b. Ap. 3, 1783. 7. JOHN SWAIN, b. Aug. 10, 1785, d. 1817.
-
235. 516 (V.) AMOS LAWRENCE, of Groton, m., in Groton, Dec. 31, 1772, BETTY HUBBARD, b. Dec. 24, 1750. dr. of Nathan and Mary (Patterson) Hubbard. She d. July 24, 1822, aged 72, and he d. May 1, 1825, aged 75.
-
1. AMOS, b. Sept. 30, d. Oct. 4, 1773. 2. ABIGAIL, b. Oct. 9, 1774, d. Aug. 13, 1775.
- 517 3. AMOS, b. July 10, 1776, d. Ap. 17, 1822. 4. ABIGAIL, b. Ap. 27, 1778.
- 518 5. ASA, b. July 21, 1780.
- 519 6. BETSEY, b. June 24, 1782, d. 1827; m., about 1804, Dr. LOVEJOY, of Townsend. He has a son, *Lawrence*, in Baltimore.
-
240. 520 (V.) SAMUEL LAWRENCE, a Deacon and a Major, of Groton; m., 1777, SUSANNA PARKER (?) b. Oct. 10, 1755, dr. of William and Susanna (Kemp) Parker, of Groton. He d. Nov. 8, 1827, aged 73, and his wid. d. May 2, 1845, aged 89. "He was one of those who rallied at Concord to oppose the progress of the British troops. When the news of their approach reached Groton, he was in the field, when, mounting his horse, he rode through the adjoining towns, giving the alarm, and returned in season to join his company at the meeting-house. In the battle of Bunker Hill, he received a slight wound, and his hat and coat, pierced with the balls of the enemy, were preserved many years. At the time of his marriage, while the ceremony was in progress, the tolling of the meeting-house bell called out the minute men, whereupon he parted from his bride as soon as the rite was finished, and marched to Rhode Island. He soon returned on a furlough of a few days, after which she did not see him again until after the birth of their first-born. He continued in the service until the close of the war; was promoted to the rank of Major, and was in many of the hardest fought battles of the Revolution.
- "Respected and beloved by his townsmen, they willingly elected him to those

offices in which he would serve. Hospitable and kind in his manners, a pleasant remembrance is still cherished of the cordial welcome and comforts his house afforded. He was an exemplary Christian, and a deacon of the church. He was one of the originators of *Groton Academy*, now most appropriately entitled '*The Lawrence Academy*.' In this school his children received their early education, and well have they remembered its origin, and the advantages they there enjoyed." Chil.,

528. 521 1. LUTHER, b. Sept. 28, 1778, d. 1839.
2. SAMUEL, b. July 2, 1781, d. May 22, 1796.
533. 522 3. WILLIAM, b. Sept. 7, 1783, of Groton, and of Boston, d. in 1848.
539. 523 4. AMOS, b. Ap. 22, 1786; of Boston; d. Dec. 31, 1852.
- 523} 5. SUSANNA, b. May 24, 1788, d. Aug. 15, 1815, unm.
524 6. MARY, b. Nov. 12, 1790; m., July 28, 1818, Rev. SAMUEL WOODBURY, grad. Dart. Coll. 1811; studied law with Luther Lawrence, Esq., her brother. He afterwards studied theology with President Brown, of Dart. College. He d. July 6, 1819, leaving a wid., who still (1855) remains in widowhood, and one child, viz.,
1. Sarah Lawrence, b. Sept. 20, 1819; m., Mar. 1841, Rev. David Fosdick. Chil.,
1. Samuel Woodbury, b. Dec. 10, 1841. 2. Mary, b. Feb. 19, 1844.
3. George, b. Jan. 14, 1846.
543. 525 7. ABBOTT, b. Dec. 16, 1792, of Boston.
- 526 8. ELIZA, b. Mar. 13, 1796; m., Jan. 5, 1824, JOSHUA GREEN, grad. Harv. Coll. 1818; M.D. 1821; M.M.S.S., of Groton. Chil.,
1. William Lawrence, b. Oct. 28, 1824, d. Aug. 28, 1825.
2. William Lawrence, b. Aug. 2, 1826; d. Oct. 21, 1847.
3. Henry Atkinson, b. Ap. 29, 1828.
4. Samuel Abbott, b. Mar. 16, 1830; grad. Harv. Coll. 1851.
5. Elizabeth, b. June 5, 1832; m., Oct. 5, 1854, John Kendall, of Washington, D. C.
6. Joshua, b. May 7, 1834, d. Feb. 13, 1846.
549. 527 9. SAMUEL, b. Jan. 15, 1801, of Lowell.
-
521. 528 (VI.) LUTHER LAWRENCE, Esq., grad. Harv. Coll. 1801; a counsellor-at-law; some time resident of Groton, engaged in a very extensive professional business; Rep. in the State Legislature, and speaker of the House. He afterwards moved to Lowell, was elected mayor of that city, and was very active and influential in promoting its prosperity. He d. suddenly, Ap. 17, 1839, aged 61, killed by falling into an open wheel-pit, while showing it to a friend. He m., June 2, 1805, LUCY BIGELOW, dr. of Col. Timothy Bigelow, of Worcester, and younger sister of Hon. Timothy Bigelow, of Groton. [Bigelow, 196.] Chil.,
- 529 1. ANNA MARIA, b. Mar. 25, 1806; m., Dec. 1, 1829, NORMAN SEAVER, Esq., of Boston; grad. Harv. Coll. 1822. He d. in St. Louis, May 12, 1838, leaving 3 children. 1. Edward Lowell, b. Jan. 11, 1831. 2. Norman, b. Ap. 23, 1834.
3. Emily, b. Nov. 5, 1835.
2. EMILY, b. June 24, 1807, d. 1808.
- 530 3. ELIZABETH ANDREWS, b. June 29, 1809, d. Aug. 19, 1830.
- 531 4. KATHERINE, b. Ap. 26, 1811, d. Ap. 18, 1846; m. CHARLES T. APPLETON. 3 drs.
- 532 5. RUFUS BIGELOW, b. July 13, 1814; grad. Harv. Coll. 1834, d. Jan. 13, 1841, at Pégu, in the south of France, where he had gone for the improvement of his health. He had studied law, and his excellent talents and address gave the promise of ample success in his profession.
-
522. 533 (VI.) WILLIAM LAWRENCE, Esq., at first a farmer, of Groton; sometimes teaching in the winter; afterwards a merchant, of Boston, where he was very successful. He was proprietor of his father's homestead, and he evinced his liberal spirit, and his interest in the prosperity of his native town, and in the good education of the rising generations, by giving to Lawrence Academy, a permanent endowment of fifteen thousand dollars (\$15,000). "He was a member of the State Legislature for several years, and he took an active part in effecting that arrangement, known as 'the Suffolk Bank System,' which has been so useful in securing a uniform currency in New England." He m., May 20, 1813, SUSAN RUGGLES BORDMAN, of Boston. He d. Oct. 14, 1848, aged 65. Chil.,

- 534 1. WILLIAM BORDMAN, b. Feb. 18, 1814; d. Sept. 7, 1840.
 535 2. SAMUEL ABBOTT, b. July 28, 1815; m. Nov. 24, 1845, SALLY C. BUNKER, dr. of Nathan Bunker, merchant, of Philadelphia. He formerly travelled through Europe, in company with Norman Seaver, Esq., his cousin by marriage, and he has resided much abroad.
 3. LYDIA ELIZABETH, b. June 15, d. June 29, 1818.
 4. SARAH, b. Aug. 20, d. Aug. 24, 1819.
 5. GEORGE HENRY, b. Jan. 9, 1821; d. Feb. 5, 1825 (or 23).
 536 6. SUSAN ELIZABETH, b. Oct. 5, 1822; m., Mar. 30, 1843, WILLIAM W. TUCKER, of Derry, N. H. Chil.,
 1. *Wm. Lawrence*, b. 1844. 2. *Alan*, b. Ap. 20, 1848.
 7. MARY BORDMAN, b. Feb. 21, d. Aug. 24, 1824.
 537 8. HARRIET BORDMAN, b. Jan. 8, 1826; m., Sept. 11, 1848, SETH EDWARD SPRAGUE, Esq., of Boston; grad. Harv. Coll., 1841; LL.B., 1843. Chil.,
 1. *William Lawrence*, b. July 20, 1849. 2. *Fanny Bordman*, b. Sept. 29, 1851.
 538 9. MARY FANNY, b. Aug. 19, 1828; m., Mar. 3, 1852, HENRY A. WHITNEY, merchant, of Boston. Chil., 1. *Harry Lawrence*, b. Oct. 27, 1853.

523. 539 (VI.) AMOS LAWRENCE, Esq., of Boston. He engaged early in mercantile life, as a clerk in Groton, where he remained until he attained his majority. He then, in Ap. 1807, went to Boston, and, after serving a short time as a clerk, he so far won the favor of his employers, by his energy and sagacity, that they proposed to him a partnership in their firm, which, however, he wisely declined. The next Dec. (1807), he commenced business on his own account. His business increased rapidly, and was attended with unvarying prosperity. He invited his brother Abbott to Boston, and, when arrived at the proper age, made him a full partner in business. Then originated that mercantile house (A. and A. Lawrence), of which he was the head about forty years, and which, for success and honorable repute, has probably never been surpassed in New England.

His success is not attributable to good luck in hazardous adventures, but to a rare sagacity and energy, that "commanded uniform and great success. His judgment was shown not merely in his purchases, and in the lines of business on which he entered, but also in the selection of agents, clerks, and partners, and in deciding whom he might safely trust. He never, or very rarely, made bad debts. It is said, there has been no man in Boston, who took hold of business with the same grasp and energy. Quick in his perceptions, deciding as by intuition, and prompt in action, he is said to have had, in those days, little patience with the slow, the inefficient, the dainty, or those who felt above their business."

He continued in active business for twenty-five years. At the end of that time he was so suddenly, and so deeply prostrated, by drinking cold water when heated, that for many days he was not expected to recover. Although he survived this attack about 20 years, his health continued very delicate, and he often had sudden attacks of such severity, that he did not expect to survive. After this failure of his health, "he gave no attention to the details of business, but remained the senior partner of the firm, giving counsel and general direction, being consulted and relied on in all questions of difficulty and importance."

It is extremely rare to find in the same person such an earnest disposition, united with such ample ability, to do good. A simple detail of the events of his life—of his beneficence, and the wise discretion, and kindly manner in which it was accomplished—would be a better eulogium on this munificent benefactor, than any highly wrought rhetoric. Fidelity to the cause of humanity, by holding up for imitation so worthy an example, demands those details to be stated now, which could not have been done in his lifetime, without wounding the sensibility of one, who unfeignedly shunned notoriety. But it does not comport with the plan and scope of this work to enter into such details. [For a delineation of his character and services, see the Sermon of his pastor, Rev. Dr. S. K. Lothrop; Prof. Packard's Hist. of the Bunker Hill Monument; but especially the excellent discourse of President Hopkins, "Commemoration of Amos Lawrence."]

He m. (1st), June 6, 1811, SARAH RICHARDS, dr. of Giles and Sarah (Adams) Richards, of Dedham, and granddr. of Rev. Amos and Elizabeth (Prentice) Adams, of Roxbury. [See Prentice Family, p. 100.] She d. Jan. 14, 1819,

and he m. (2d) Mrs. NANCY ELLIS, wid. of Judge Ellis, and dr. of Col. Robert Means, of Amherst, N. H. Mr. Lawrence d. suddenly Dec. 31, 1852, aged 67. Chil.,

- 540 1. WILLIAM RICHARDS, b. May 3, 1812; of Brookline; m., Dec. 6, 1838, SUSAN COOMBS DANA, dr. of Rev. Samuel Dana, of Marblehead (grad. Harv. Coll., 1796), and granddr. of Rev. Joseph Dana, of Ipswich (grad. Yale Coll., 1769), a descendant of Richard Dana, of Cambridge. He was in mercantile business a short time; afterwards studied medicine, M.D. Harv. Coll., 1845, M.M.S.S. Chil.,
 1. *Francis William*, b. Nov. 20, 1839. 2. *Arthur*, b. Aug. 22, 1842.
 3. *Robert Means*, b. June, 1847.
- 541 2. AMOS ADAMS, b. July 31, 1814, grad. Harv. Coll., 1835; a merchant manufacturer, of Boston; m., Mar. 31, 1842, SARAH E. APPLETON, dr. of William Appleton, Esq., of Boston.
 1. *Marianne Appleton*, b. in Boston, May 12, 1843.
 2. *Sarah*, b. in Brookline, July 5, 1845.
 3. *Amos Appleton*, b. in Boston, Ap. 22, 1848.
 4. *William*, b. in Boston, Mar. 30, 1850.
 5. *Susan Mason*, b. in Brookline, Feb. 4, 1852.
- 542 3. SUSANNAH, b. May 23, 1817; m., June 15, 1838, Rev. CHARLES MASON, grad. Harv. Coll., 1832; of Salem, now of Boston; son of Hon. Jeremiah Mason, and a nephew of her father's 2d wife. She d. in childbed, Dec. 2, 1844, leaving 4 children. 1. *Susan Lawrence*, b. Aug. 25, 1839. 2. *Amos Lawrence*, b. Ap. 20, 1842. 3. *Mary*, and 4. *Sarah* (twins), b. Nov. 23, 1844.
 (By 2d wife, Mrs. Nancy Ellis.)
 4. MARY MEANS, b. Ap. 15, 1823; d. Dec. 8, 1828.
 5. ROBERT MEANS, b. Sept. 17, 1826; d. Nov. 1, 1845, aged 19.

525. 543 (VI.) Hon. ABBOTT LAWRENCE, merchant, of Boston. He has been repeatedly Rep. of Boston, in U. S. Congress, and for several years, was resident Minister of the U. States, at the Court of St. James. He has founded and endowed in Harv. College, a School of Science, applied to the Arts. A full account of his beneficence, of his public services, and of the influence he has exerted in promoting domestic industry, and public improvements, would now be untimely. [See 539, and 549.] He m., June 26, 1819, KATHERINE BIGELOW, dr. of Hon. Timothy Bigelow, of Groton, who was the great grandson of the first John Bigelow, of Watertown. [Bigelow, 195.] Chil.,

- 544 1. ANNIE BIGELOW, b. Ap. 28, 1820; m., in 1846, BENJAMIN SMITH ROTCH, grad. Harv. Coll., 1838; of New Bedford. Chil., 1. *Edith*, b. July 30, 1847.
 2. *Arthur*, b. May 13, 1850. 3. *Aimée*, b. June 16, 1852.
- 545 2. JAMES, b. Dec. 6, 1821; grad. Harv. Coll., 1840; merchant, of Boston; m., Mar. 16, 1852, ELIZABETH PRESCOTT, dr. of William H. Prescott, LL.D., the historian. Chil., 1. *James*, b. Mar. 23, 1853. 2. Daughter, b. Feb. 19, 1855.
 3. GEORGE, d. in infancy. 4. JOHN ABBOTT, d. in infancy.
- 546 5. TIMOTHY BIGELOW, b. Nov. 22, 1826; grad. Harv. Coll., 1846; m. (1st), at Louisville, Ky., Dec. 5, 1848, SALLIE, dr. of Robert F. Ward, Esq. He m. (2d), Mar. 16, 1854, ELIZABETH CHAPMAN, dr. of Henry and Elizabeth (Stewart) Chapman, and granddr. of Abraham Chapman, Esq., of Doylestown, Penn.
- 547 6. ABBOTT, b. Sept. 9, 1828; grad. Harv. Coll., 1849; m., Ap. 12, 1853, HARRIETTE WHITE PAIGE, dr. of J. W. and H. S. Paige.
- 548 7. KATHERINE BIGELOW, b. Feb. 7, 1832; m., June 1, 1854, AUGUSTUS LOWELL, grad. Harv. Coll., 1850, son of John A. Lowell, of Boston. ✓

527. 549 (VI.) SAMUEL LAWRENCE. In his minority, he went to live with his brother William, in Boston, and soon after attaining his majority, became his partner in business. This occasioned him to make many voyages to England, and to spend much time abroad. After he and his brothers became so deeply interested in manufactures on the Merrimac, he moved to Lowell, where he long resided, until recently he moved to Boston. He and his brother, Hon. Abbott Lawrence, are considered the projectors and founders of the City of Lawrence. He m., Ap. 2, 1833, ALISON TURNBULL, youngest dr. of William Turnbull, formerly mer-

chant, of Philadelphia, who m. Mary, dr. of Rev. Charles Nisbet, D.D., Pres. of Dickinson College.* Chil.,

1. CHARLES, b. May 27, 1835; d. Ap. 15, 1842.
 550 2. HENRY, b. Ap. 28, 1837. 3. GEORGE, b. Jan. 22, 1839.
 552 4. MARY, b. Oct. 26, 1841. 5. ALISON, b. May 24, 1843.
 554 6. NISBET, b. Nov. 29, 1844. 7. SAMUEL, b. Sept. 27, 1846.
 556 8. AMORY.

263. 558 (VI.) EBER LAWRENCE, many years a merchant, of Amherst, N. H.; afterwards a broker, of Boston, now (1855) residing with his son William, in Burlington, Mass. He m. (1st) LUCY BURTON, of Woburn, by whom he had one child. He m. (2d) JANE DENNISON FROST, dr. of Ichabod Frost. Chil.,

- 559 1. WILLIAM, of Burlington, Mass., m., Aug. 13, 1823, LUCY BOTSFORD, dr. of John and Huldah (Nichols) Botsford, of Newtown, Fairfield Co., Conn. Chil.,
 560 1. *Lucy Julia*, b. July 13, 1824; m. O. H. Hendley, a grocer, of E. Camb.
 561 2. *James Kent*, b. Mar. 8, 1826.
 562 3. *Elizabeth Earl*, b. Ap. 2, 1827; d. Feb. 10, 1830.
 562 4. *William Burton*, b. Oct. 11, 1831.
 563 5. *Mary Jane*, b. Sept. 12, 1834; d. Ap. 11, 1840.
 563 6. *Eber Henry*, b. Jan. 9, 1838.
 (By 2d wife, Jane D.)
 564 2. JANE CUMMINGS, b. Sept. 29, 1802; m. DAVID UNDERHILL, s. p.
 565 3. GEORGE FROST, b. Mar. 5, 1804; m.; was assassinated in Texas.
 566 4. ADELIN ELIZA, b. Oct. 14, 1806.
 567 5. EBER STILLMAN, b. Aug. 20, 1807, d.

* [The following record is inserted here although not of a Watertown family, presuming that it will be interesting to a considerable number of readers.]

- 1 Rev. CHARLES NISBET, D.D. came from Montrose, Scotland, in the spring of 1786, on the invitation of the Trustees of Dickinson College, Carlisle, Penn., to be its President. He died in 1804. He married ANNIE TWEEDIE. Chil.,
- 2 1. THOMAS, d. unm.
 3 2. MARY, m. WILLIAM TURNBULL, then merchant, of Philadelphia. Chil.,
 4 1. *Ann*. 2. *Betsy*, died unm.
 5 3. *Susan*, m. *Alexander Murdock*, merchant, of Baltimore.
 6 4. *William*, a Major in U. S. Corps of Topographical Engineers; m. *Jane Ramsay*, of Washington.
 7 5. *Charles*, d. at sea, unm.
 8 6. *Alexander*, merchant, of Baltimore; m. *Fanny Nisbet*. [34.]
 9 7. *Caroline*, died unm.
 10 8. *Henry*, a farmer, of Baltimore Co., m. *Ann Smith*, dr. of Samuel F. Smith, President of Philadelphia Bank.
 11 9. *Alison*, m. *Samuel Lawrence* [549], of Lowell, now of Boston.
 12 3. ALISON, b. in Montrose, Scotland, 1772; m., Jan. 1, 1796, SAMUEL ALLEN MCCOSKRY, M.D., a physician, of Carlisle, Penn. Chil.,
 13 1. *Eliza*, d. in Philadelphia, 1836, unm.
 14 2. *Charles Nisbet*, grad. Dick. Coll., 1815; M.D. Univ., Penn., 1819; d. at St. Augustine, Florida, unm.
 15 3. *William*, a physician, d. at St. Augustine, unm.
 16 4. *Mary*, m., in 1827, Rev. *Erikine Mason*, grad. Dick. Coll., 1823, D.D., Columb. Coll.; for 25 years pastor of Bleeker St. Church, N. Y. He d. May 14, 1861. Chil.,
 17 1. Alison, b. Oct., 1828. 2. Anna, b. Sept., 1833.
 18 3. Erskine, b. May, 1837. 4. Mary, b. Nov., 1839.
 19 5. *Samuel Allen*, grad. Dick. Coll., 1824; D.D. Columb. Coll.; some time rector of St. Paul's Church, Philadelphia; now Bishop of the P. E. C., of the diocese of Michigan. He m. *Eliza L. Montgomery*, dr. of Dr. Montgomery, of Allentown, New Jersey.
 20 1. Mary, b. May, 1829; m., in 1854, Stephen K. Stanton, a lawyer of Detroit.
 21 2. *Alison Nisbet*, m., Mar. 29, 1831, *Charles Dexter Cleveland*, b. in Salem, Mass., son of Rev. Charles and Mehitabel (Treadwell) Cleveland, grad. Dart. Coll., 1827; in 1830, Prof. of Greek and Latin languages in Dick. Coll.; in 1832, Prof. of the Lat. Lang. and Lit., in the New York University; since 1834, Principal of a Young Ladies' School, in Philadelphia; author of "Compendium of English Literature;" "Eng. Lit. of the 19th Century," and numerous other educational works; also editor of an edition of Milton's Poems. Chil.,
 22 1. Alison Nisbet, b. Mar. 10, 1832; d. Jan. 14, 1837.
 23 2. Charles Dexter, b. Aug. 7, 1834; d. May 15, 1841.
 24 3. Samuel McCoskry, b. Dec. 7, 1837. 4. Alison Nisbet, b. Nov. 8, 1839.
 25 5. Charles Dexter, b. July 6, 1841; d. Ap. 6, 1843.
 26 6. Treadwell, b. Ap. 6, 1843. 7. Wilberforce, b. June 3, 1846; d. June 27, 1847.
 27 8. Eliza, b. May 13, 1848. 9. Lucy, b. Aug. 18, 1851.
 28 4. ALEXANDER, grad. Dick. Coll., 1794; a lawyer, of Baltimore, and for many years one of the Judges of the Criminal Court; m. MARY C. OWINGS, of Baltimore. Chil.,
 29 1. *Colegate*, m. *Alexander D. Brown*, a farmer, of Baltimore Co.
 30 2. *Cassandra*, m. *T. I. Lee*, Capt. U. S. Corps Topog. Engineers.
 31 3. *Ann*.
 32 4. *Fanny*, m. her cousin, *Alexander Turnbull*. [9.]
 33
 34

- 568 6. ALMIRA SHERMAN, b. Sept. 29, 1809; m. FULSOM D. DORSET, and settled in Delavan, Ill.
- 569 7. ELIZA ANN, b. Nov. 24, 1811; m., and settled in Kingston, Island of Jamaica.
- 570 8. SARAH CHARLOTTE, b. Aug. 26, 1814; m. RICHARD F. SASS, of Charleston, S. C.; now a merchant, of St. Louis.
- 571 9. HANNAH GIBSON, b. June 2, 1816; m. — VAN WINKLE.
- 572 10. HENRY PURKITT, b. Dec. 13, 181—.
- 573 11. CHARLES AUSTIN, b. Dec. 1, 1822.
-
264. 574 (VI.) AARON LAWRENCE, m., Mar. 8, 1802, LUCY PUTNAM, b. May 19, 1786, dr. of Nathan Putnam, of Stowe, Mass. Chil.,
-
- 575 1. LUCY PUTNAM, b. in Hollis, N. H., May 22, 1803; m., Feb. 9, 1825, AMBROSE PEASE, a merchant, son of Obadiah Pease, of Landgrove, Vt. He d. Oct. 27, 1847, aged 47. She d. in Weston, Vt., May 22, 1850. Chil.,
- 576 1. *Sylvanus A.*, b. in Landgrove, Nov. 21, 1825, a merchant, at Saratoga Springs, d. Jan. 27, 1849, unm.
- 577 2. *Lucy L.*, b. in L., Ap. 13, 1827.
- 578 3. *Angeline L.*, b. in Weston, Vt., Nov. 6, 1828; m., Ap. 18, 1850, *David O. Gale*, of Londonderry, Vt. 2 chil.
- 579 4. *Andrew J.*, b. in W., Dec. 1, 1830. 5. *Pliny M.*, b. in W., Feb. 28, 1833.
- 580 6. *Alona*, b. in W., Ap. 5, 1836; d. in Westford, Ky., Mar. 20, 1852.
- 581 7. *Lawrence P.*, b. in W., Dec. 24, 1838.
- 582 2. AARON, b. in H., Dec. 23, 1804; m. (1st), Sept. 14, 1830, LUCRETIA CLAGGET, dr. of Judge Clagget, of Amherst, N. H. She d. Sept. 15, 1838, and he m. (2d), Dec. 14, 1842, SARAH ABBOT STEARNS, dr. of Timothy and Sarah (Low) Stearns, of Billerica. [See I. Stearns, p. 470.] He was formerly a merchant, of Amherst, doing business in the store previously occupied by his uncle Eber. In 1841, he retired from business on account of ill-health; but he has since resumed it, and has been an extensive hop-dealer. Chil.,
- 583 1. *Elizabeth Greely*, b. Nov. 9, 1831.
- 584 2. *Cornelia Margaretta*, b. June 24, 1837.
(By 2d wife, Sarah A. S.)
- 585 3. *Sarah Lucretia*, b. Nov. 6, 1843. 4. *Ann Maria*, b. Ap. 4, 1847.
- 587 3. MARY PUTNAM, b. in Stowe, Mass., Mar. 27, 1807; m., Dec. 17, 1829, PERKINS WILEY (son of Major David Wiley, of Landgrove, Vt.), many years a merchant, in Weston, Vt. Chil., all b. in Weston.
- 588 1. *Randolph P.*, b. Sept. 23, 1830; d. Oct. 7, 1840.
- 589 2. *M. Cornelia*, b. Mar. 18, 1832.
- 591 3. *Eliza Ann*, b. Mar. 2, 1835. 4. *Lucy Jane*, b. July 1, 1838.
- 592 5. *N. Caroline*, b. Sept. 19, 1840; d. Feb. 10, 1842. 6. *Henry Clay*, b. Dec. 4, 1844.
- 592 4. DAVID, b. in S., Feb. 24, 1809; a merchant, at Hooksett, N. H.; d. in Weston, Vt., May 3, 1833.
- 593 5. JANE DUNCAN, b. in Hancock, N. H., Feb. 9, 1811; m., in 1850, JOSEPH P. GATES, a machinist, of Versailles, Ky.
- 594 6. ALONA, b. in H., Feb. 4, 1813; d. Aug. 25, 1841; m., Aug. 30, 1836, FRANKLIN KEYES.
- 595 7. WILHELMINA CAROLINE, b. in H., Ap. 14, 1815; d. Sept. 7, 1839, disease of the heart.
- 596 8. DOROTHY M., b. in H., Jan. 28, 1817; m., Aug. 17, 1843, SIMEON D. SPAULDING, a farmer, son of Simeon Spaulding, of Weston, Vt.
- 597 1. *Melvin L.*, b. in Boston, Oct. 30, 1845.
- 598 9. NANCY B., b. Mar. 31, 1819; d. in Weston, Vt., June 16, 1842.
- 599 10. SARAH SUSANNAH, b. in Weston, Vt., June 8, 1821.
- 600 11. ELIZA ANN C., b. Aug. 4, 1823; m., Sept. 4, 1842, FRANKLIN KEYES, Esq., a merchant, of Weston, Vt., now (1853) of Logansport, Ia.
367. 601 (V.) JONAS LAWRENCE, of Canaan, Conn., m. Sept. 3, 1754, TRYPHENA LAWRENCE, of Littleton, Mass. [291.] He d. May 22, 1793, and she d. in West Stockbridge, Mass., Jan. 31, 1795. Chil.,

- 602 1. LYDIA.
603 2. WILLIAM SOLOMON, m. Oct. 12, 1780, ESTHER DUTTON. He d. 1797. Chil.,
604 1. *Sophia*, m. *Russell Fowler*, and had sons *Levellan*, *Roger*, *Hiram*, and *Russell*,
and *drs. Samantha*, *Sophia*, *Mary Ellen*; and *Adaline Metesia*.
605 2. *Betsy*, m. *Austin Fowler*, and had sons *Franklin Dutton*, *Jordan Nickle*,
William Washington, *Cyrus Elijah*, and *drs. Eliza Emeline*, *Adelia Expe-*
rience, *Amanda Maria*.
606 3. *Charlotte*, m. *John P. House*. Chil., *Philip*, *Orange*, *John*, *Austin*, *James*,
Lavinia, *Esther*, *Sarah*, and *Elizabeth*.
607 4. *Experience*, m. *Joel Gaylord*. Chil., *William*, *Joseph*, *Horace*.
608 5. *Rebecca*, m. *David Hammond*. Chil., *Ransom*, *Oliver*, *Stafford*, *David*, *Sophia*,
Ether.
609 6. *Erastus*, d. unm., at *Natchez*, about 1839.
610 7. *Cyrus*, m., and had *Charles*, *William*, *Lafayette*, and others.
611 8. *Orange*, of *Orangeville*, *C. W.*; m., about 1820, *Sarah House*. Chil., *Cyrus*,
Ferris, *Orange*, *Mary*, *Esther*, *Frances*, *Rhoda*, *Sarah*.
612 3. ABIAH, b. Nov. 30, 1760; m. STEPHEN BROWN [152], of *West Stockbridge*.
613 1. *Hannah*, m. — *Southwick*. 8 chil., one of whom, *Lucius*, is now (1852)
living at *Mount Morris*, *N. Y.*
614 2. *Lydia*, b. Feb. 23, 1785; m., May 8, 1809, *David Brinsmaid*, b. Oct. 8, 1782,
d. Ap. 10, 1837. Chil.,
615 1. *Albert Lawrence*, b. Feb. 2, 1810, of *Mishawaka*, *la.*; m., Feb. 1839,
Martha Belden. Chil., *Henry*, *Lydia*, *Louisa*.
2. *Louisa*, b. Jan. 23, 1812, d. Ap. 24, 1814.
3. *Abigail Charlotte*, b. June 1, 1814, d. Sept. 20, 1841.
616 4. *Henry*, b. Nov. 20, 1815; of *Rochester*, *N. Y.*; m., Oct. 15, 1845,
Susan Alma King. Chil., *Elizabeth*, *Dolly*, and *Alma Susan*.
617 5. *Matilda*, b. Oct. 27, 1817; m., Aug. 23, 1849, *Julius Nelson Wilbur*,
of *Alto*, *Wis.* Chil., *Charlotte*, *Amanda*, *Frances*, *Augustus*.
618 6. *Charles Grandison*, b. Mar. 19, 1820; of *Le Roy*, *N. Y.*; m., Oct.
1847, *Mary Jane Bostwick*.
619 7. *Amanda Melvina*, b. May 29, 1823; m., Aug. 18, 1823, *Joel Tyler Bene-*
dict, of *New York*.
620 8. *Sophia Abiah*, b. Aug. 26, 1825. 9. *Sophia Jane*, b. May 9, 1827.
622 4. ABEL, b. Sept. 22, 1763, of *Canaan*; m. (1st), Oct. 6, 1783, *ABIGAIL ROCKWELL*.
He m. (2d), Feb. 8, 1791, *LUCINA GRANGER*, b. Dec. 19, 1770, d. Feb. 8, 1831.
He d. July 26, 1835. By 1st wife 2 chil., who d. in infancy.
(By 2d wife, *Lucina*)
627 3. *Tryphena*, b. Sept. 22, 1793.
628 4. *Jonas*, b. Sept. 14, 1794; m. Jan. 29, 1830, *Ann Thomas*. Chil.,
629 1. *Sevellan Fowler*, b. Feb. 19, 1832.
630 2. *Lazette*, b. Mar. 2, 1835. 3. *George Starr*, b. Aug. 17, 1836.
4. *Elizabeth Delano*, b. Mar. 27, 1842.
631 5. *Abigail*.
632 6. *William Solomon*, b. Oct. 19, 1797; m. (1st), Feb. 6, 1823, *Milla Capron Richard-*
son. She d. Jan. 25, 1835. He m. (2d), July 5, 1835, *Theresa Minerva Thomas*.
633 1. *Milla Mary*, b. Oct. 11, 1823; m., Dec. 11, 1845, *James Daniel Borthwick*.
634 2. *Sabra Lucina*, b. Sept. 23, 1826; m., Aug. 10, 1843, *Henry Cross*, and
d. 1844.
635 3. *William Albert*, b. Ap. 6, 1831; m., May 31, 1851, *Electa M. Reese*.
4. *Anson Howard*, b. Sept. 4, d. Nov. 12, 1834.
(By 2d wife, *Theresa M.*)
636 5. *Victoria*, b. Aug. 22, 1838. 6. *James Henry*, b. Feb. 5, 1849, d. Dec. 11, 1850.
637 7. *Bersheba Lucina*, b. Jan. 16, 1800; m. June 19, 1823, *Anson Miner Howard*,
and they reside in *Oshkosh*, *Wis.* Chil.,
638 1. *Richard Lawrence*, b. Mar. 3, 1824; m., May 13, 1847, *Abigail O.*
Lockerby.
639 2. *Charlotte Lucina*, b. Aug. 27, 1826; m., Ap. 8, 1847, *J. Burton Fisher*.
640 3. *George Henry*, b. Ap. 18, 1829.
641 4. *Adaline Louisa*, b. Sept. 16, 1831; m., June 24, 1847, *Luman Leach*.
642 5. *Mary Celestina*, b. Dec. 9, 1833. 6. *Helen Amelia*, b. Mar. 5, 1837.
644 7. *Franklin Fowler*, b. Mar. 15, 1844. 8. *Emily Eliza*, b. Ap. 4, 1846.
646 8. *Joel Granger*, b. Jan. 2, 1801; m., June 11, 1839, *Sarah Ann Wheaton*.

- 647 1. John Wheaton, b. Ap. 22, 1840. 2. Abigail Seloma, b. Jan. 3, 1842.
 649 3. Horace Franklin, b. Dec. 13, 1847.
- 650 9. *Charlotte*, b. Dec. 26, 1804; m. Jan. 14, 1826, *Pomeroy Gorsline*.
 651 1. Mary S., b. and d. Feb. 1827. 2. Andrew J., b. Feb. 17, 1828.
 653 3. Angeline, b. Nov. 1829, d. Jan. 1830. 4. Gilbert H., b. Oct. 29, 1830.
 655 5. Pomeroy, b. June 18, 1833. 6. Charlotte M., b. Ap. 11, 1835.
 657 7. child, b. and d. Ap. 1837. 8. Abel L., b. Mar. 7, 1838.
 659 9. Lucina, b. Dec. 22, 1840. 10. Jose C., b. Nov. 24, 1843.
- 661 10. *Susan*, b. Aug. 26, 1806; m., in 1827, *James S. Gorsline*.
 662 1. Charles P., b. Jan. 21, 1828. 2. William C., b. Sept. 6, 1829.
 664 3. Mary Angeline, b. June 7, 1831. 4. child, b. Sept. d. Oct. 1834.
 5. George Starr, b. Sept. 1835, d. Mar. 1836.
- 666 11. *Wealthy L.*, b. Sept. 30, 1808; m. Feb. 1, 1827, *Elisha Forsyth*, of Newark, N. Y., b. in Owego, Feb. 14, 1801.
- 667 1. Julia Ann, b. May 26, 1828; m., Sept. 16, 1844, John D. Baker.
 668 2. Morgiana, b. Mar. 1, 1830; m., Mar. 20, 1848, Joseph A. Tyler.
 3. Charles Eldridge, b. Jan. 20, 1832, d. Mar. 26, 1833.
- 669 4. Hubbard Truman, b. Aug. 3, 1834. 5. Gilbert Treat, b. Aug. 29, 1838.
 671 6. George Francis, b. Jan. 29, 1840.
 7. William Lawrence, b. June 11, 1842.
- 673 8. Lucina Cross, b. Nov. 11, 1844. 9. Edmund Augustus, b. Ap. 29, 1849.
- 675 5. JOSIAH, b. Oct. 16, 1765, d. Ap. 30, 1832; m. (1st), Feb. 7, 1788, AMY ROCKWELL, b. May 4, 1762, d. May 17, 1812. He m. (2d), PHEBE, wid. of William Faxon, and dr. of Nathaniel Lawrence [154]. Chil.,
- 676 1. *Abiah*, b. Nov. 28, 1788; m. Dr. *Ovid Plumb*, son of the late Dr. Frederick Plumb, of Canaan, Conn.
 2. *Harvey*, b. Mar. 19, 1791; m. Nov. 22, 1812, *Betsy Dunning*.
 678 1. Amy, b. June 10, 1815; m. Hiram Andrews.
 679 2. Edmund D., b. Jan. 20, 1820. 3. Catherine C., b. June 30, 1822.
- 681 3. *Abigail*, b. Jan. 29, 1793; m. Dec. 30, 1812, *Sereno B. Gillet*. She d. in childbed, June 5, 1816, leaving son Lawrence, b. June 5, 1816; m., Jan. 12, 1839, Abigail Lawrence.
- 683 4. *Betsy*, b. Feb. 25, 1799; m., Nov. 4, 1823, *John Franklin*.
 684 1. Charlotte L., b. Mar. 11, 1827. 2. Edward, b. Mar. 11, 1831.
 686 3. Hugh White, b. May 22, 1834.
- 687 5. *Charlotte*, b. May 4, 1802; m. Sept. 15, 1824, *William Adam*.
 688 1. Robert W., b. Sept. 28, 1825. 2. Frances C., b. Aug. 31, 1830.
 690 3. Sarah W., b. Ap. 28, 1836.
 (By 2d wife, Phebe.)
- 691 6. *Isaac*, b. Nov. 28, 1814.
 692 7. *George K.*, b. Feb. 9, 1817; m., Mar. 26, 1840, *Huldah H. Tuckerman*.
- 693 6. TRYPHENA, b. July 4, 1768, d. Mar. 30, 1800. She m., about 1787, HUGH WHITE, of Whitesboro, N. Y. [For an account of their romantic courtship, see Genealogy of Isaac Lawrence, p. 20.] Chil.,
- 694 1. *Robert*, b. Nov. 27, 1788. He lived many years in profound retirement, and d. at a time and place unknown, leaving, it is said, six children.
 695 2. *Canvass*, b. Sept. 8, 1790. He m. *Louisa Loomis*, and d. Dec. 18, 1834, at St. Augustine, where he had gone in pursuit of health. He was distinguished as a civil engineer.
- 696 1. Charles L. 2. Cornelia P., m., in Aug., 1852, Henry R. Barnes, of Summit Hill, Carbon Co., Penn. 3. Susan.
- 698 3. *Charlotte*, b. Oct. 15, 1792; m. *Essek Walcott*, and moved to Walnut Hills, Miss., where she died.
 1. Charlotte. 2. Edward. 3. Ann. 4. Louisa.
- 699 4. *Tryphena*, b. Sept. 30, 1794; d.
- 700 5. *Sophia*, b. Jan. 6, 1796; m. John Duston, now of Kingston, Mo.
- 701 6. *Hugh*, b. Dec. 25, 1798; of Waterford, Saratoga Co., N. Y. Several times elected Rep. to Congress from that district; m. *Maria M. Mansfield*, of Kent, Conn. Chil. living in 1853,
 702 1. William M., b. July 8, 1833. 2. Isabel, b. Mar. 22, 1837.
 704 3. Charlotte, b. Jan. 6, 1843.
- 705 7. CHARLOTTE, b. Oct. 13, 1770, d. Aug. 31, 1800; m., Nov. 23, 1786, ISAAC DUNHAM, b. 1764, d. Oct. 20, 1821. Chil.,

- 706 1. *William*, b. Mar. 20, 1787; m., at Berkshire, Tioga County, N. Y., Oct. 1822, *Matilda Slausson*, b. in Berkshire Co., Mass., May 31, 1804. Chil. all b. in Richford, Tioga Co., and family now (1853) reside in N. York.
- 707 1. *William S.*, b. Aug. 22, 1825. 2. *Matilda Orcelia*, b. July 19, 1828.
- 709 3. *Robert S.*, b. June 29, 1832. 4. *Isaac S.* (twin), b. and d. June 29, 1832.
- 710 2. *James*, b. Feb. 20, 1789.
- 711 3. *Harvey*, b. Ap. 10, 1791; m., Dec. 31, 1812, *Lydia Loveland*, b. in Sandisfield, Mass., Jan. 29, 1791.
- 712 1. *Permelia*, b. Nov. 11, 1813, d. July 24, 1838.
- 713 2. *Isaac*, b. Sept. 7, 1815; m., Sept. 1, 1840, *Elizabeth Snyder*, b. at Toghkanie, Columbia Co., N. Y., Feb. 1, 1821. 4 chil.
- 714 3. *Asahel*, b. Nov. 26, 1819; m., July 4, 1839, *Matilda Curtis*, b. Aug. 21, 1823.
- 715 4. *Harvey*, b. July 9, 1825. 5. *Lydia*, b. July 12, 1828.
- 717 6. *Charlotte*, b. Feb. 15, 1831; m., Nov. 4, 1849, *Henry Johnson*, b. Ap. 17, 1828.
- 718 4. *Jonathan*, b. May 31, 1794; d. in Sheffield, Mass., Ap. 27, 1835.
- 719 5. *Tryphena*, b. Jan. 27, 1797; m. *Ephraim Dickson*.
- 720 6. *Charlotte*, b. Oct. 21, 1799; m. *Stephen Crittenden*, of Henderson, Jefferson Co., N. Y. Chil.,
- 721 1. *Orcelia*, b. Aug. 18, 1820. 2. *James*, b. Nov. 25, 1823.
- 723 3. *Isaac*, b. Feb. 10, 1824; of Henderson; m., Ap. 23, 1851, *Nancy Gridley*, of Oneida Co.
- 724 8. *CONSIDER*, b. Feb. 8, 1777; m., Sept. 11, 1796, *WEALTHY PECK*, b. Oct. 27, 1775.
- 725 1. *Maria*, b. Aug. 30, 1797; m., Ap., 1816, *Thomas Langdon*.
- 726 1. *Wealthy*, b. July 27, 1817; m., Dec., 1838, *Stanley Sheffield Hinman*, now (1853) of Monroeton, Penn.
- 727 2. *Benjamin*, b. June 6, 1819; m., Sept., 1846, *Eveline Perry*, of Owego, and they live in Monroeton, Penn.
- 727 3. *Eliza*, b. Sept. 1, 1822; m., Sept., 1846, *William Wiltse*, of Speedville.
- 728 2. *Isaac P.*, b. Feb. 8, 1799; m., Jan. 20, 1821, *Catherine Cole*.
- 729 1. *Amy Loretta*, b. Ap. 14, 1824; m., Jan. 7, 1849, *Otis Lyon*, of Monroeton.
- 730 2. *Wealthy Cornelia*, b. Oct. 19, 1827; m., and lives in Knoxville, Penn.
- 731 3. *Miles Lewis*, b. Nov. 6, 1800; of Berkshire; m., Mar. 26, 1834, *Silvia C. Foot*.
- 732 1. *Martha Caroline*, b. June 6, 1836. 2. *Mary Elvira*, b. Mar. 1, 1838.
- 734 3. *Wm. Josiah*, b. Jan. 7, 1839. 4. *Emma Caroline*, b. Feb. 5, 1840.
- 736 5. *Miles Arlington*, b. June 20, 1842. 6. *Lucy Foot*, b. June 6, 1844.
- 738 7. *Celia Gertrude*, b. July 27, 1846. 8. *Wealthy Louisa*, b. Oct. 17, 1850.
- 740 4. *William*, b. Feb. 14, 1803; m., Sept. 14, 1840, *Laura Woodruff*.
- 741 1. *Wm. Stanley*, b. Dec. 31, 1843. 2. *Oscar Selwin*, b. June 25, 1845.
- 743 3. *Asalia Caroline*, b. Dec. 1, 1847. 4. *Geo. Willis*, b. Dec. 3, 1849.
- 745 5. *Betsy*, b. Aug. 27, 1804; m., Dec. 25, 1821, *Gamaliel Whiting*.
- 746 1. *Harris*, b. Aug. 24, 1822. 2. *Gamaliel*, b. May 9, 1824.
- 748 3. *Alanson*. 4. *Alonzo* (twins), b. June 9, 1827.
- 750 5. *Delia Sophia*, b. May 28, 1831.
- 751 6. *Josiah*, b. Sept. 14, 1806; m. *Martha Baird*.
- 752 9. *WILLIAM*, b. Jan. 31, 1779; m., Oct. 7, 1801, *LOTTE WOOD*, b. Nov. 30, 1783.
- 753 1. *Laura*, b. Nov. 5, 1802; m., Oct. 13, 1825, *Daniel Norton*, d. Sept. 22, 1848, at New Hartford, Conn., and buried in Canaan.
- 754 1. *Julia L.*, b. Dec. 17, 1826. 2. *Susan P.*, b. Dec. 20, 1829.
- 756 3. *Jane E.*, b. May 19, 1832. 4. *Loania V.*, b. July 3, 1835.
- 758 5. *William P.*, b. Jan. 11, 1839. 6. *Edward D.*, b. May 16, 1841.
- 760 2. *Julia*, b. Sept. 18, 1804; m., Sept. 18, 1832, *Frederick S. Pease*, of Albany. Author of the "Genealogy of Isaac Lawrence," and other similar works. See note, p. 819.
- 761 3. *William*, b. July 22, 1806; m. *Chloe Beecher*.
- 762 1. *William H.*, b. July 29, 1831. 2. *George J.*, b. Oct., 1834.
- 764 4. *Jane*, b. July 29, 1808; m., Nov., 1833, *Charles W. Franklin*.
- 765 5. *Maria*, b. Mar. 21, 1811; m., Sept. 21, 1848, *Charles S. Adam*, son of Samuel F. Adam, of Canaan, Conn.
- 766 6. *Frederick*, b. Aug. 15, 1813; m. (1st), Jan. 1, 1838, *Elizabeth A. Pease*. She d. May 1, 1840, and he m (2d) *Helen M. Pease*.

- 767 1. Elizabeth F., b. May 1, 1840.
(By 2d wife, Helen M.)
- 768 2. Helen A., b. Mar. 29, 1846. 3. Fred. Stow, b. about 1850.
- 770 7. Lorenzo, b. Nov. 29, 1816.
- 771 8. Abigail, b. Mar. 11, 1819; m., Jan. 2, 1839, *Lawrence Gillett*.
- 772 1. Harriet E., b. Dec. 29, 1839. 2. Josiah L., b. Feb. 14, 1843.
- 774 3. Ellen L., b. Ap. 19, 1846.
- 775 9. Harriet, b. June 6, 1823.
-
368. 776 (V.) SAMUEL HYDE, of Norwich, Conn., m., Oct. 25, 1750, AZUBAH LAWRENCE. Neither the dates, nor the order of the births of their children have been ascertained, with one exception. Chil.,
-
- 777 1. ASA. 2. LYDIA, m. SAMUEL BARNEY.
- 779 3. HANNAH, m., in 1779, TIMOTHY CAPEN. She d. July 12, 1827, and he d. May 3, 1834. Chil.,
- 780 1. Abiah, b. Nov. 2, 1780; d. Nov. 25, 1851; m., Sept. 22, 1811, *James Raymond*, of North Brookfield, Mass. One dr. H. S.
- 781 2. Asa H., b. May 12, 1783; m., May 8, 1808, *Anna Peirce*. Chil.,
- 782 1. Samuel, b. Jan. 2, d. Mar. 20, 1809.
2. Asa, b. July 5, 1810; d. Mar. 28, 1811.
- 782 3. Sally Cordelia, b. Mar. 14, 1812; m., June 30, 1842, Samuel Dawes.
- 783 1. Melona C., b. Sept. 9, 1846.
4. Salmon, b. Sept. 21, 1814; m., May 5, 1840, Betsey M. Thompson.
- 784 1. Arthur C., b. Mar. 18, 1841.
5. Daniel, b. Dec. 2, 1816; m., Ap. 28, 1840, Irene S. Tower.
- 785 1. Sarah R., b. June 10, 1841. 2. Ward D., b. Mar. 14, 1844; d. May, 1846.
6. Howland D., b. Dec. 16, 1820; m., Mar. 14, 1843, Mehitabel Allen. 2 drs., Ellen C. and Martha E.
- 786 3. Azubah, b. Sept. 14, 1785; m., Ap., 1814, *Nathan Hobbs*, moved to the West.
- 787 1. Silas W., b. Dec., 1815. 2. Timothy C., b. Ap., 1818.
- 789 3. Harlow F., d. in the Mexican war. 4. Mary C.
- 790 4. Polly, b. Aug. 24, 1788.
- 791 5. Daniel, b. Mar. 15, 1791; m., June 5, 1814, *Lucy Cummins*.
- 793 4. BETTY REBECCA, b. Ap. 28, 1770; d. May 22, 1834, aged 64 yrs. 24 days; m., in 1790, DANIEL FENN, who was living in Alford, Mass., in 1851, aged 85.
- 794 1. William B., b. Aug. 26, 1792; of Alford, Mass.
- 795 2. Harlow, b. Feb. 2, 1794; m., July 24, 1816, *Hannah Bogardus*.
- 796 1. Lewis, b. May 9, 1817; of Troy, N. Y.; m. Mary Jane White.
- 797 2. Jane Eliza, b. Jan. 28, 1830; m., Dec. 13, 1848, William Root.
3. Cynthia Cordelia, b. Ap. 28, 1796; d. Feb. 2, 1811.
- 798 4. Lewis, b. Jan. 17, 1798. 5. Daniel B., of Stockbridge, Mass.
- 800 6. Edwin H., of Alford, Mass. 7. Henry C., of Stockbridge, Mass.
- 802 5. MATILDA, m. CHRISTOPHER MINER, and settled in Ohio. 5 chil.
- 803 6. SAMUEL, m. ANNA WHITING. 7. TRYPHENA. 8. POLLY. 9. SOLOMON.
-
379. 807 (V.) ELIJAH COBB, of Canaan, Conn., m. AMY LAWRENCE, Mar. 30, 1760.
- 808 1: ELIJAH WILLIAM, d. May, 1816, aged 51 yrs.; m., in Salisbury, Conn., Feb. 27, 1786, SALLY WHITNEY, who d. June, 1825, aged 54.
- 809 1. Joshua, b. Nov. 1786; d. May 2, 1851, aged 64 yrs. and 6 m.; m., June, 1816, *Susan Doty*. Chil., 1. Hiram D. 2. Eliza. 3. Amanda. 4. Henry. 5. Sarah. 6. Elijah. 7. Lyman.
- 810 2. *Permelia*, b. Jan. 20, 1791; d. Feb. 11, 1830, aged 39. She m., in 1811, *Isaiah G. Barker*.
1. Rhoda, d. Feb., 1830. 2. Mary Ann, m. — Birdsell.
3. Eliza, d. 1826. 4. Beda. 5. *Permelia*, d. 6 and 7 twin sisters, d.
8. Lyman. 9. William, m., in 1851, Eliza D. Lincoln, of Pike, Allegheny Co.
- 811 3. *Charilla*, b. Dec. 5, 1793; m. *John Burnett*, of Hampton, Conn., a widower with 4 chil. He d. 1834.
1. James Francis, b. Mar. 2, 1828; d. Jan. 1, 1849.
2. Lyman Cobb, b. Mar. 22, 1830; d. Dec. 4, 1840.

- 812 4. *Daniel Johns*, b. Oct. 18, 1795; m., in 1822, *Charlotte Hoyt*.
1. Thomas. 2. Charlotte. 3. Daniel. 4. Lyman, d. 5. Clarissa.
6. Francis.
- 813 5. *Lydia E.*, b. Mar. 19, 1798; m., in 1815, *Thomas Davis*.
1. Retsey. 2. Sarah. 3. Lydia. 4. James, and 5. George, twins.
6. Thomas. 7. Mary.
- 814 6. *Lyman*, b. Sept. 18, 1800; well known as the author of several school-
books; m., Ap. 7, 1822, in Caroline, Tompkins Co., N. Y., *Harriet Chambers*.
- 815 1. Sarah Jane, b. in Rochester, N. Y., Mar. 20, 1823; m., in New York,
July 1, 1846, Wm. C. Duncan, and d. July 7, 1847, s. p.
- 816 2. Eleanor Mack, b. in Berkshire, Tioga Co., N. Y., Ap. 3, 1825; m., in
N. York, Ap. 18, 1849, and d. Oct. 11, 1851. 2 chil.
- 817 3. Lyman, b. in Caroline, Tompkins Co., N. Y., Sept. 18, 1826; m., in
1845. 2 chil.
- 818 4. Hannah Louisa, b. in C., Aug. 13, 1828; m., July 24, 1850, David H.
Crittenden.
- 819 5. George Whitney, b. in N. York, Oct. 11, 1835.
- 820 6. Wm. Henry, b. June 12, 1837.
- 821 7. Charles Frederick, b. in N. York, Dec. 3, 1848.
- 822 8. Eugene Wheaton, b. Oct. 16, 1851.
- 823 7. *Nancy*, b. Oct. 18, 1802; d. June 27, 1836; m., in 1826, — *Jewett*. 5 chil.
- 824 8. *Sarah W.*, b. Nov. 13, 1804; m. *J. Preshov*.
- 825 2. DOLLY, m. GEORGE WHITE, of Salisbury, Conn. He d. Mar., 1809, and she d.
Feb. 17, 1815, both in Canaan.
- 826 1. *Henry*, b. May 15, 1787; m. *Ann M. Platt*, of New Milford, Conn., where
he settled. He d. in Newtown, Conn., Oct. 13, 1842.
- 827 1. Harriet, b. Ap. 26, 1811; m., Dec. 23, 1830, George W. Polly, b. in
Troy, N. Y., Mar. 14, 1810, and settled in Middleton, Yates Co., N. Y.
- 828 1. Eliza Jane, b. Sept. 8, 1831. 2. Mary Sophia, b. May 20, 1833.
- 830 3. Julia Melissa, b. Oct. 28, 1834; m., Nov. 11, 1851, Ephraim C.
Williams, b. June 23, 1823, in Middlesex, where they reside.
- 831 4. George Henry, b. May 12, 1838. 5. Theodore Bouton, b. Dec.
4, 1840.
- 833 6. Stanley Howard, b. May 7, 1844. 7. Florence Melora, b. Feb.
17, 1847.
- 835 2. Henry, b. Feb. 26, 1813; d. at Danbury, Conn., Aug. 16, 1832.
- 836 3. Caroline, b. Aug. 22, 1815; m., May 7, 1843, John B. Judson, b. in
N. York, now of Bridgeport, Conn. Chil.,
- 837 1. Isabel Jane, b. May 31, 1844. 2. John Martin, b. June 6, 1848.
- 839 3. Alice, b. May 26, 1851; d. 1852.
- 840 4. Mary Ann, b. Sept. 2, 1817; m., Jan. 28, 1837, Enoch Bouton, b. at
South East, N. York, Mar. 27, 1816, now of Bridgeport.
- 841 1. Wm. Edgar, b. June 1, 1842. 2. Susan, b. Jan., d. Feb., 1844.
- 842 3. George Washington, b. Jan. 22, 1847.
- 843 5. George Washington, b. Jan. 22, 1820; m. (1st), Dec. 1, 1841, Ann
King, b. in New York. 1 child. She d., and he m. (2d), Nov. 27, 1844,
Phebe E. Wood, b. in N. York, Nov. 8, 1826. They reside in Mount
Vernon, N. Y. Chil., 1. George W., b. Sept. 23, 1845. 2. Leonora,
b. Mar. 13, 1847. 3. Mary Ann, b. Sept. 27, 1849.
- †843 2. *Mary*, b. June 2, 1788; m., Dec. 6, 1810, *Elijah Curtis*, of Stockbridge,
Mass., now (1853) of Newark Valley, Tioga Co., N. Y.
- †844 1. Frederick, b. in Stockbridge, Oct. 25, 1811; m., Feb. 5, 1838, Louisa-
Smith, of Union, Broome Co., N. Y. Chil.,
1. De Witt, b. Feb. 2, 1839; d. 1844. 2. Mary, b. Nov. 29, 1841.
3. Emma, b. Oct. 15, 1843; d. 1847. 4. Ella, b. Mar. 20, 1846.
5. Caroline Alphae, b. Ap. 29, 1848. 6. Elijah, b. Sept. 14, 1851.
2. Mary, b. in S., Feb. 11, 1814; d. Sept. 7, 1815.
- 844 3. Isaac, b. in S., July 11, 1817. 4. son, b. and d. 1820.
- 45 5. Caroline, b. in Newark, May 5, 1822; m., Jan. 29, 1840, Alfred
Rich. She d. Feb. 6, 1844, leaving son Franklin, b. Feb. 18, 1842.
- 846 6. Mark Hopkins, b. in N., Oct. 20, 1824.
- 847 3. *Cornelia*, b. Sept. 26, 1791; m., Oct., 1810, *Harlow Fellows*, of Canaan,
where they have always resided. He d. Sept. 4, 1851. Chil.,

- 848 1. Eliza, b. May 11, 1814; m. Ransom Moore, of Canaan.
 849 1. Albert, b. Oct., 1832; of South Adams, married.
 850 2. Irene, b. July 22, 1836. 3. Cornelia, b. May, 1839.
 851 2. Mary Ann, b. July 7, 1816; m., Dec. 25, 1835, John Foster, and
 settled in Canaan. Chil., 1. Frederick F., b. Nov. 10, 1836.
 853 2. Frances Cornelia, b. June 2, 1841.
 854 3. William Henry, b. May 17, 1824; m., July 25, 1850, Abby Steward,
 of Chatham, N. Y., where he settled.
 855 4. Charles Henry, b. July 1, 1832; m., Jan. 7, 1849, Mary N. Tripp, of
 New Bedford, and moved to Dayton, Ohio.
 856 4. Isaac, b. June 11, 1794; m., Jan., 1828, Sarah Beckley, of South Canaan,
 where they settled.
 857 5. John, b. Ap. 15, 1797; m., Mar. 10, 1819, Amanda Root, of South Canaan,
 where they settled.
 858 1. Fanny Maria, b. Mar. 6, 1820; m., Aug., 1837, William Gillett, of
 South Canaan. Chil., 1. Infant, d. June, 1838.
 2. Henry, b. Nov., 1841. 3. John, b. Aug., 1845; d. Sept., 1848.
 4. Frances, b. July 22, 1850.
 859 2. Emily, b. Ap. 5, 1822; m., Mar., 1840, Gurdon Davidson, of S. Canaan.
 1. George, b. Feb., 1841. 2. Asa, b. Oct., 1842; d. Feb., 1846.
 3. Amanda, b. June 7, 1845. 4. Eunice Maria, b. Nov., 1847.
 5. Isaac, b. Jan., 1849. 6. son, b. Aug., 1852.
 860 3. Dolly, b. May 19, 1824; m., Mar. 6, 1842, George Barnes, of Canaan.
 She d. Ap. 16, 1843, leaving dr. Harriet, b. Jan. 31, 1843.
 861 4. Isaac George, b. July 25, 1827; m., May 31, 1852, Bridget M'Manus.
 862 5. John Henry, b. Jan. 22, 1830; m., July 4, 1852, Amanda Parmelee.
 863 6. Washington Riley, b. Oct. 3, 1832.
 864 7. Frederick Curtis, b. Nov. 29, 1834.
 865 6. Dolly, b. Oct. 13, 1803; m., Jan. 18, 1834, Ezekiel Fuller, of Salisbury,
 Conn.; settled first in Athens, N. Y., thence moved to Windham, Greene
 Co., N. Y., where he d. Sept. 4, 1850. 2 chil. She m. (2d), Sept. 12, 1852,
 Horace C. Beckley, of S. Canaan.

380. 866 (V.) WILLARD KINGSBURY, of Canaan, Conn., m. HANNAH LAWRENCE.
 Neither the dates, nor the order, of the births of their children have been ascer-
 tained.

- 867 1. ANDREW, of Rush, Monroe, Co. N. Y.
 868 2. ARDON, of Elmira, Chemung Co., N. Y.
 869 3. PHILO, of Oswego, Tioga Co., N. Y.
 870 4. LYDIA, of Rush, N. Y. 5. HANNAH.
 872 6. JOHN (probably the eldest son), of Canaan; m., May 8, 1794, REBECCA GRIS-
 WOLD. Chil.,
 1. Rebecca, b. Jan. 1, 1795, d. Mar. 21, 1799.
 873 2. John, b. May 14, 1796; m., Feb. 9, 1820, Fanny Fox.
 874 1. Roxy S., b. Aug. 30, 1820; m., Oct. 1, 1845, Charles A. Palmer, of
 Riga, N. Y., and d. May 3, 1847.
 875 2. Harlow C., b. May 3, 1822; m., Dec. 22, 1849, Elizabeth Henderson.
 876 3. Harriet C., b. Oct. 27, 1829; m., July 10, 1848, Charles A. Palmer,
 and d. Mar. 15, 1852.
 4. Adaline M., b. July 22, 1832, d. July 2, 1848.
 5. Angeline E. (twin), b. July 22, 1832.
 877 3. Harlow, b. Ap. 22, 1798, d. at Augusta, Ga., Aug. 22, 1822.
 878 4. Lyman, b. Ap. 14, 1800; m., Feb. 4, 1835, Almira Brown.
 879 1. Horace, b. Jan. 21, 1836. 2. Edgar L., b. Jan. 17, 1838, d. 1844.
 880 3. Willard L., b. Mar. 30, 1842. 4. Edgar L., b. Feb. 28, 1845.
 881 5. Eliza, b. Feb. 14, 1802, d. May 19, 1807.
 883 6. Caroline, b. Jan. 5, 1804; m., Nov. 18, 1823, Charles Palmer, of Coventry,
 Conn. She d. May 21, 1832.
 884 1. Eliza S., b. Aug. 31, 1824; m., Aug. 1, 1848, Samuel N. Sprague, of
 Coventry, Conn.
 2. Chauncey H., b. Sept. 20, 1826, d. July 29, 1836.
 885 3. Caroline O., b. June 9, 1830.

- 886 7. *Willard L.*, b. Feb. 3, 1808; m., Nov. 22, 1841, *Elvira Pinney*, and d. Mar. 7, 1842.
- 887 8. *Hannah*, b. May 27, 1812.
- 888 9. *Mary*, b. Ap. 14, 1815; m., May 8, 1841, *Harrison Hoskins*.
- 889 1. *Mary Rebecca*, b. Nov. 11, 1842.
2. *Caroline Hannah*, b. Sept. 16, 1845.
10. *Sophia*, b. Aug. 11, 1817, d. Oct. 13, 1818.
-
382. 890 (VII.) EDMUND LAWRENCE, a farmer, m. 1795, MARY STEARNS [I. Stearns, 390, V.] After the birth of one child, he moved from Westminster, N. H., to Marlboro, Vt. In 1811, he moved to Edinburg, Saratoga Co., N. Y. He d. Feb. 6, 1813, and his wid. Sarah d. in Day, N. Y., Mar. 10, 1850, aged 76.
- 891 1. EDMUND, b. in Westminster, N. H., Jan. 26, 1796; m., Mar. 3, 1818, ELLATHERE PERRY, b. Mar. 15, 1799; and he settled in Day, Saratoga Co., N. Y. He d. Jan. 4, 1840.
- 892 1. *William*, b. Aug. 13, 1819, a cordwainer, of Edinburg, N. Y.; m. *Chloe Bugby*.
- 893 2. *John*, b. Mar. 14, 1821; a farmer, of Day, N. Y.; m., Dec. 28, 1849; *Cynthia Akely*, b. Sept. 18, 1828.
- 894 3. *Eunice*, b. June 18, 1823.
- 895 4. *Nathaniel T.*, b. Sept. 1825; a farmer of Clarkson, Munroe Co., N. Y. m.
- 896 5. *Edmund*, b. July 15, 1827, d. Aug. 25, 1849.
- 897 6. *Lorenzo D.*, b. July 5, 1829; a farmer, of Edinburg; m., May 8, 1853, *Jane Ann Clancy*, b. Aug. 15, 1830.
- 898 7. *Elliot*, b. Oct. 28, 1831. 8. *Elizabeth*, b. Oct. 25, 1833.
- 900 9. *Warren*, b. Ap. 2, 1835. 10. *Wright*, b. Nov. 15, 1837.
2. WILLIAM, b. in Marlboro, Vt., Mar. 21, 1798, d. May 3, 1813.
- 902 3. NATHANIEL, b. Feb. 22, 1800, d. Dec. 18, 1843; a farmer, of Day, N. Y.; m., Aug. 8, 1824, MARY MILLER, b. 1806. He was a Justice of the Peace, and was often intrusted with town business.
1. *Mary Ann*, b. May 8, 1825, d. Mar. 30, 1841.
2. *Nathaniel W.*, b. July 3, 1827, d. June 26, 1847.
- 903 3. *Emily L.*, b. June 2, 1829; m., Dec. 9, 184-, *Warren Bloss*, a farmer.
- 904 4. *Wesley N.*, b. Sept. 7, 1831; m., Mar. 1851, *Jane Hempstead*.
- 905 5. *Sarah M.*, b. Mar. 29, 1834, d. Dec. 26, 1835.
6. *Sophonra*, b. Feb. 12, 1836.
4. JONAS, b. Ap. 18, d. Nov. 29, 1802.
- 906 5. SALLY, b. Feb. 17, 1804, d. Mar. 10, 1850.
- 907 6. STEWARD K., b. Jan. 3, 1806; a carpenter, of Day, N. Y.; m., Jan. 15, 1828, OLIVE STEPHENSON, b. 1811.
- 908 1. *Albert S.*, b. Feb. 21, 1830; a carpenter; m., Dec. 30, 1852, *Maria Bloss*, b. Dec. 6, 1837.
- 909 2. *Marcus E.*, b. Nov. 6, 1831. 3. *George B.*, b. Aug. 14, 1833.
- 911 4. *Addison G.*, b. Dec. 8, 1835. 5. *Louisa L.*, b. Sept. 9, 1838.
- 913 6. *Phila R.*, b. Ap. 27, 1840. 7. *Rosilia A.*, b. July 5, 1842.
- 915 8. *Dewitt U.*, b. Feb. 15, 1845. 9. *Ann Amelia*, b. Nov. 14, 1847.
- 917 10. *Francis E.*, b. Feb. 23, 1850.
- 918 7. RULY, b. Feb. 25, 1808.
8. RHODA, b. July 18, 1810, d. Mar. 13, 1815.
- 919 9. FRANKLIN B., b. in Edinburg, N. Y., Oct. 5, 1812; a farmer, of Day, Saratoga Co., N. Y.; m., Jan. 17, 1839, SARAH C. SAVAGE, b. Ap. 16, 1811. Chil.,
1. *Sarah Jane*, b. Oct. 14, 1839. 2. *Juliana*, b. Oct. 1, 1841.
- 920 3. *Isaac S.*, b. Aug. 21, 1843. 4. *Edward A.*, b. Ap. 2, 1845.
- 922 5. *Mary*, b. Ap. 5, 1847. 6. *Hiram F.*, b. July 20, 1850.

p. 333. LEADBEATER.—Mar. 10, 1763, order to apprise the estate of Henry Leadbeater, of Weston. Inventory, £8 5s. 6d.

LEARNED.—[1.] Ap. 2, 1661, Ralph Shepherd was appointed administrator of wid. Jane Learned.

[2.] Ap. 6, 1658, admin. granted to wid. Mary, and her father, Isaac Sterne. Ap-

praisal of the estate of Isaac Learned, of Chelmsford, made Dec. 7, 1657, in presence of Isaac Sternes, £187 18s. 6d. Estate indebted to wid. Learned £8, and her annuity during her widowhood. Was this that wid. Jane who d. in 1661?

p. 334. [4.] This Joseph Farwell was probably a son of Henry Farwell, and b. in Concord, Feb. 26, 1640-1. [General Reg. iv., p. 272.]

[16.] (?) Samuel Learned belonged to a force sent against the Indians in 1725. [See General Reg. vii., p. 64.]

[18.] May not this Elizabeth Learned be (by a misnomer), that Esther Learned who m., in 1715, Thomas Marshall, of Newton? [Jackson's Hist. of Newton, p. 364.]

[19.] July 4, 1769, wid. Lydia and Josiah Stone, administrators of Moses Learned.

p. 335. [32.] The heirs of Capt. Edward Learned, of Sherburne, state that his wid. d. Jan. 11, 1783. Signed Jan. 14, 1783, by Edward, Samuel, and Anne Learned, Jedediah Phipps, Edward W. Perry, and Sarah Clark.

[42.] Thomas Learned was first licensed as an innkeeper, June 30, 1712, and was selectman 1725 and 29. His real estate was appraised in 1732 by Samuel Jackson, [Col.] Ephraim Williams, and John Spring, all of Newton. His wid. continued to obtain a renewal of the license until 1764. The next year her son Abijah obtained a license, and kept the house about two years, when he relinquished it to Benjamin Prentice, and moved to Cambridge. In 1770 the house was taken and kept about two years by another son, Bezaleel. Admin. on estate of wid. Mary Learned was granted May 1, 1770, to Bezaleel Learned; Abijah Learned, yeoman, of Camb., and Samuel Norcross, brickmaker, of Camb., sureties. Her inventory included the furniture of bar and bar-room.

[54.] Joshua Learned m. Sarah Seaver, of Brighton [Coolidge, 164].

p. 336. [64.] Jedediah Learned belonged to Capt. Jonathan Brown's Co. at Lake George in 1758.

[69.] (?) Jonas Learned belonged to Capt. Abijah Child's Co. at Camb., Jan., 1776.

[70.] David Learned d. of quinsy, Mar. 19, 1754.

[71.] Thomas Learned m. Hannah, dr. of Dea. Ebenezer Brooks, of Medford [see Brooks, 107, p. 724.] Ebenezer Learned (supposed to be his son, and named for his grandfather Brooks), grad. Harv. Coll. 1787; M.D. Dart. Coll. 1820, N.H.M.S.S.; settled in Hopkinton, N. H.; d. 1831.

[77.] Oliver Learned, of Dedham previous to May, 1764.

[79.] Joshua Learned d. Dec. 25, 1745.

[85.] Sarah, wife of Abijah Learned, d. in Camb., May 8, 1745, aged 28. In Nov. or Dec. 1765, he moved from Camb. to Wat. with wife Sarah, with chil. Mary, Abigail, and Nathaniel. See above [42].

p. 337. [93.] For Blunden, read Blanden. Susan Blanden, b. July 13, 1750, was a dr. of Francis, Jr., and Susanna (Bailey), and gr. dr. of Francis, Sen., and Elizabeth (Hyde) Blanden, of Newton.

[98.] Jonas Learned, wife and chil., moved to Camb. in May, 1766. Caution by Camb., Sept. 4, 1770, against (settlement of) Jonas Learned, about ten years old, son of Jonas, d.

LEASON.—(Gleason). For adm. freeman, read, took oath of fidelity.

LESTER.—Jan. 10, 1654-5, the selectmen ordered 40s. or 50s. to be laid out for the necessity of Goodman Lester.

LEWIS.—EDMUND LEWIS moved from Wat. to Lynn, after Nov., 1642, where he d. Jan., 1651, and his wid. MARY, d. Sept. 7, 1658. Chil.,

1. John, b. in England, in 1631; m., in Lynn, June 17, 1659, *Hannah*, dr. of Capt. Thomas Marshall. Chil.,

1. John, b. Mar. 30, 1660. 2. Hannah, b. Feb. 25, 1662.

3. Thomas, b. June 2, 1663. 4. Mary, b. Feb. 24, 1666.

5. Benjamin, b. Ap. 27, 1667. 6. Samuel, b. July 25, d. Aug. 12, 1675.

7. Abigail, b. May 16, 1679. 8. Ebenezer, b. July 16, 1681.

9. Elizabeth, b. Ap. 7, 1684.

2. *Thomas*, b. in England, in 1633; m., Nov. 11, 1659, *Hannah Baker*. Chil.,

1. Edward, b. July 28, 1660. 2. Thomas, b. Ap. 29, 1668.

3. *James*, b. in Wat., Jan. 15, 1635-6.

4. *Nathaniel*, b. in Wat., Aug. 25, 1639; m. — — — Chil.,

1. Nathaniel, b. Aug. 20, 1676. 2. Mary, b. Dec. 4, 1677.

5. A child, aged 20 days, buried in Wat., Nov. 6, 1642.

LINTON.—It is supposed that Richard Linton, of Wat., went to Concord, and resided a few years (1638 to 1642), and there bore the name of Lettin; and that thence he moved to Lancaster with the first settlers. Richard Lynton was at Mr. Cradock's plantation, in Sept., 1630.

p. 338. **LIVERMORE.**—[1.] It is probable that John Livermore settled first in Watertown, and very soon went to Connecticut, with other Watertown people. In the first place, a large portion of the passengers of the Francis, with whom he embarked at Ipswich, in Ap., 1634, settled in Watertown. In the second place, he was adm. freeman with several other Watertown men, in May, 1635. In the third place, his name is on a list of very early proprietors of Watertown. This list is not dated, but it contains the names of many of those, who went to Wethersfield and Dedham, in 1635 and 36. The first notice of him in Connecticut, was in 1639, when he, then of New Haven, signed the fundamental agreement of the New Haven colony. His autograph may be seen in vol. i., p. 1, of the Col. Rec. of New Haven. It is not improbable that he went to Wethersfield, and remained there until the settlement of New Haven was projected, when he and Robert Seely joined the planters of that town. He was "admitted a member of the Court" (i. e. made a freeman of the colony), Oct. 29, 1640, and took the oath of allegiance, July 1, 1644. June 11, 1645, "It was proposed that another ordinary might be set up towards the waterside," and it was "left with John Livermore to consider of it." [Col. Rec. of N. H., I., p. 103.] His home lot, which has been identified, was on the west side of Fleet Street, next but one to the Harbor. May 17, 1647, Joseph Nash was chosen corporal, "in room of John Livermore, who expects to go to England." His name does not appear in the records again, until Jan., 1648-9, after an interval of about 20 months; and it is probable that he was in England. May 7, 1650, "John Livermore hath sold and passeth to Theophilus Higginson, his house and house-lot $\frac{1}{2}$ acre and 10 perches; 8 acres $\frac{1}{2}$, 15 rods on this side the West River, next the land of Richard Beach; 6 $\frac{1}{2}$ acres 25 rods, on the other side the West River, next Milford highway, by the meadow side; 28 acres of the 2d division, betwixt the lands of Edward Banister and Richard Osborne; 5 acres of meadow in the West Meadow, next meadow of Henry Gibbons; 3 acres of meadow in Solitary Cove, with the work-houses, with the land belonging to them; bounded with stump of a tree next the sea, running along the creek to the end of the house—being in breadth so wide as the house is." [Col. Rec., N. Haven, II., p. 18.]

John Livermore

It is probable that Mr. Livermore left New Haven, about the date of this sale, as his name does not afterwards occur in the records. It has not been ascertained whether he went directly to Watertown, but it is probable, as he was a juror in July, 1653. From the rule for assessing in New Haven, it appears that John Livermore had a wife and two children when he went there, or soon after, as he was rated for four persons [not including servants], and £100 estate. In the first "seating the meeting-house," in 1642, seats were assigned to John Livermore, and to "sister Livermore." Children bap. in New Haven. 1. Samuel, bap. Aug. 15, 1641. 2. Daniel, bap. Oct. 7, 1643. 3. A daughter, bap. June 4, 1645. 4. Mary, bap. Sept. 12, 1647. Daniel was living at the date of his father's Will (1683), then aged 40 yrs., but he is not mentioned in the Will of his mother (1690). Mary Livermore and John Russell m., in Charlestown, Nov. 12, 1691. Was this Mary the widow of Daniel, or was it the Mary bap. in New Haven, 1647, but not mentioned in the Will of either of her parents? [10.] The "Cowpen Farm," upon which Lieut. John Livermore settled, was on or near the border of Sudbury, and he was a member of Sud. Church, until the organization of Weston Church ("the Farmer's Church"), of which he was an original member. Elizabeth, his dr. (probably by his 2d wife), was adm. f. c. Weston, 1728, and d. May 30, 1732. The Cowpen Farm was bounded N. by Robert Jennison and John Sawin; W. by Robert Jennison; E. by R. Jennison and Nathaniel Greene [son, and heir of Rev. Henry Greene]; S. by Capt. Hugh Mason. The 20 acres of meadow belonging to it, were near Nonesuch Meadow. Oct. 22, 1695, John Grout, Sen., of Sud., conveyed to [his son-in-law] John Livermore, of Watertown [Farms], a tract of land, situated between Dedham line, Wat. line, and Sud. line; adjoining partly 200 acres, granted by the General Court to William Jennison, of Watertown; bounded S. by Dedham line; N. by Sud. line; E. by Wat. line; W. by the 200 A. above-mentioned, now in the possession of Matthew Rice. Nov. 21, 1712, John Livermore conveyed

this tract of land to his four daughters, Hannah Rice, Sarah Fulham, Martha Gleason, and Mary Bigelow.

- p. 339. [20.] Samuel Livermore, bap. in New Haven, Aug. 15, 1641, was selectman of Wat., 1684 and 90. His Will, dated Dec. 5, 1690, proved June 16, 1691, constitutes wife Anna, and eldest son Samuel, exec'rs; uncle, Jonathan Danforth [youngest brother of his wife's mother], Capt. Andrew Belcher [cousin of his wife, and father of Gov. Belcher], and Simon Stone, overseers. Inventory (of real estate), dated Jan. 14, 1690-1; homestall and 44 acres, £200; 2 A. of upland in Pondfield, £6; 20 A. of dividend land, £20, 5 A. of marsh, £30.
- p. 340. [39.] Ensign Daniel Livermore m. Mehitabel Norcross. [19.]
- p. 341. [48.] For I. Stearns, 58, III., read 38, III. Sarah, wid. of Lieut. Samuel Livermore, m. (3d), Ap. 8, 1722, Hon. Ebenezer Stone [39.], of Newton. She d. 1741.
- [50.] Matthew Livermore, grad. Harv. Coll., 1722, "schoolmaster of the town," was adm. f. c. to the West [Waltham] Church, Feb. 18, 1725-6. He had been the schoolmaster most, if not all of the time after his graduation. This shows an error of dates in the Annals of Portsmouth, as to the time of his settling there. He probably went to Portsmouth in 1726, was master of the grammar-school until 1731, when he was admitted and sworn as an attorney-at-law. Soon afterward, Gov. Belcher [who was a distant relative], appointed him Attorney-General for the Province, and advocate for the King in Courts of Admiralty. "He was serious in his deportment, exemplary in his conduct, and firm in his belief of the truths of the gospel." [See Annals of Portsmouth, p. 261.] It has not been ascertained that he ever married.
- [55.] Ap. 2, 1725, John Robbins, of Camb., was appointed guardian of Abigail, dr. of Daniel Livermore, of Wat., in 18th year. Jonathan Stone was appointed guardian of Jonas, son of Daniel Livermore. This was probably that Jonas Livermore, who m., in Newton, July 3, 1735, Esther Hyde.
- [60.] Mercy Livermore. See Allen, [50.] in Part II., p. 674.
- [60½.] David Livermore and Abigail Kimball, m., in Bradford, Feb. 21, 1743-4. She was a niece of Mary, wife of Thomas Saltmarsh, of Watertown. Dec. 24, 1771, Daniel Livermore, of Concord, N. H., appointed admin'r of the estate of wid. Abigail Livermore, of Wat. (his mother).
- p. 342. [61.] Dea. Thomas Livermore was selectman of Wat. (before the incorporation of Waltham), in 1719, 20, 22, 23, 24, 25, 26, 28, 32, 33. [N.B. According to the town record, Serjt. George Livermore was selectman in 1730. This is the only place, it is believed, where this name occurs, and it may be a mistake for Thomas.]
- [75.] Dec. 10, 1705, admin. on estate of Jonathan Livermore, granted to wid. Rebecca, and his brother Daniel. Inventory dated Dec. 13, 1705. Dec. 23, 1706, wid. Rebecca presented acc't for the expense of her lying-in, and for clothing.
- [78.] For [Phillips, 85], read [Phillips, 35; also see Phillips, 27, in Part II.]
- [81-5.] (?) ELISHA LIVERMORE, of Shrewsbury, m. (pub. Nov. 4), 1780, LUCY MAYNARD, of Westboro. Chil. b. in S.
1. *Levi*, b. Dec. 15, 1781.
 2. *Emery*, b. Oct. 10, 1783.
 3. *Lucy*, and 4. *Anna*, bap. Nov. 6, 1785.
 5. *Martha*, bap. Aug. 3, 1788, d. young.
 6. *Solomon*, bap. May 5, 1790.
 7. *Harvey*, bap. Oct. 7, 1792.
 8. *Jubal*, bap. June 14, 1795.
 9. *Martha*, bap. Feb. 4, 1798. [Ward, p. 358.]
- p. 343. [89.] Capt. Nathaniel Livermore, of Weston, d. Aug. 11, 1760. Chil.,
1. Nathaniel (who d. having one child).
 2. Martha.
 3. Lucy.
- [92½.] Elizabeth, d. young.
- [100.] Oliver Livermore, was selectman of Wat., 1738, 41, 43, 46, 48, and 49.

[108.] JONATHAN LIVERMORE, of Brighton, m., Jan. 26, 1786, MARTHA ROBBINS, b. June 25, 1760, dr. of Solomon and Martha Robbins, of Newton. [Solomon Robbins d. July 25, 1801, aged 81, and his wife Martha d. Feb. 28, 1798, aged 75.] He d. Ap. 22, 1822, and his wid. d. Sept. 21, 1840. Chil.,

1. JONATHAN, b. Ap. 12, 1787, d. Mar. 20, 1829; m. EUNICE CHAPLIN.
1. *Charles*, b. Jan. 26, 1809.
2. *Jonathan*, b. Nov. 1, 1810.
3. *Elijah*, b. Ap. 7, 1812.
4. *Aaron*, b. Nov. 5, 1813.
5. *Eunice*, b. July 31, 1817.
6. *Isaac*, b. Aug. 8, 1818.
7. *William*, b. July 2, 1819.
8. *Walter*, b. Mar. 28, 1822.
2. SARAH, b. Sept. 7, 1788; m. JABEZ FISHER, of Camb. 6 chil.
3. OLIVER, b. May 22, 1790; of Camb.; m. Lois Chaplin.
1. *Oliver Willard*, b. Ap. 2, 1819.

2. *Lois*, b. Sept. 23, 1820. 3. *Francis Henry*, b. June 3, 1824.
 4. *George Albert*, b. Sept. 27, 1826. 5. *George Francis*, b. June 21, 1830.
 4. *LUCY*, b. Sept. 29, 1792; m. *CERPHAS BRACKETT*, of Brighton. 5 chil.
 5. *MARTHA*, b. Sept. 7, 1794; m., *THOMAS HASTINGS*, of E. Camb. 7 chil. [See *T. Hastings*, 83, p. 791.]
 6. *MARY*, b. June 17, 1796, d. Feb. 17, 1822.
 7. *GEORGE*, b. Sept. 21, 1798; m. *SARAH BRIGAM*, of Rindge, N. H.
 1. *Sarah Fisher* b. Ap. 23, 1834. 2. *George Brigam*, b. May 11, 1836.
 3. *Henry Munroe*, b. Jan. 5, 1841.
 8. *ELIZABETH*, b. Oct. 30, 1800.
 p. 345. [136.] *Dea. Jonathan Livermore* and wife *Abigail* were dismissed from *Waltham Church* to *Westboro*, Ap. 8, 1729.
 [152.] *Rebecca*, b. June 1, 1734; m. (pub. Aug. 29), 1761, *Henry Switcher*, of *Western*.
 [154.] *Susan*, m. (pub. Dec. 21, 1759), *Joshua Townsend*, of *Boston*.
 p. 346. [157.] *Rev. N. Potter* was settled in *Brookline*, Nov. 19, 1755, and was dismissed, June 17, 1759. He died probably about 1766 (it is said, lost at sea), as *Hannah Potter* and her dr. *Sarah* returned from *New Jersey* to *Waltham* in July, 1766. *Dr. Pierce* says he was from *Elizabethtown, N. J.*, and he probably returned thither after his dismissal from *Brookline*. [See *Hist. Mendon Asso.*, p. 211.]
 p. 347. [181.] For the parentage and lineage of *Abigail*, wife of *Nathaniel Livermore*, see *Jones* [125-5], and *Locke Fam.*, p. 64.
 p. 348. [197.] *Amos Livermore* was selectman 1779, 81, 83, 84, 85, 87, 89, 91, 92, 93, and 94. He d. Oct. 27, 1821, aged 84, and his wid., *Hepzibah*, d. Nov. 15, 1824, aged 79. [198.] *Amos L.*, a selectman, 1806, d. Nov. 17, 1841, aged 77.
 p. 351. [254.] *Hon. E. St. Loes Livermore* was Rep. in Cong. 1806 to 1812. See *Loring's 100 Boston Orators*, p. 367.
 [255.] See *Quincy's Hist. Harv. Coll. II.* 423.
 p. 352. [274.] *Hon. A. Livermore* d. in *Campton, N. H.*, July 1, 1853, aged 87.

Marriages in Weston: *Daniel Boyles* and *Mary Livermore*, both of *W.*, m., Ap. 12, 1791. *Jas. Perry*, of *Wilton, N. H.*, and *Betsey Livermore*, of *W.*, m. Nov. 19, 1795. *Ephraim Staples*, of *E. Sud.*, and *Sally Livermore*, m. June 30, 1799. *William Livermore*, of *W.*, and *Tabitha Tilton*, of *E. Sud.*, m. Jan. 3, 1800. *Joseph Moore*, of *E. Sud.*, and *Miranda Livermore*, m. Oct. 24, 1802. *Marshall S. Rice*, of *Dorchester*, and *Mary Livermore*, m. Ap. 24, 1825. *Nathan Rice*, of *Sud.*, and *Sarah L. Livermore*, m. May 30, 1831. *John Sanderson* and *Sophonria Livermore*, m. 1815. *Isaac Sanderson* and *Lucy Livermore*, m. 1815. *Calvin Harrington* and *Martha Livermore*, m., 1818. *John Mansfield*, of *Needham*, and *Elizabeth Livermore*, of *W.*, m. 1820. *Daniel Livermore*, of *W.*, and *Hannah Cutting*, of *Sud.*, m. 1822.

- p. 353. **LOCKWOOD.**—*Edmund Lockwood* applied to be adm. freeman, Oct. 1630, and was adm. May 18, 1631. He was foreman of a jury appointed by the Court, Nov. 9, 1630, on a trial for murder. He, "Mr. Lockwood," was one of the two persons appointed by the Court, May 9, 1632, for *New Towne*, to confer with the Court, "about the raising of a publick stock." At the same time he was appointed constable of *New Towne*. He d. previous to Mar. 3, 1634-5, when his wid. *Ruth* [?] *Elizabeth* was ordered by the Court to place all writings left by her husband in the hands of *John Haynes*, &c. It is very probable that he was one of those first planters of *Watertown* who went thither with *Sir Richard Saltonstall*; that upon the planting of *Newtown*, the next year, either he moved thither, or he had settled so far to the East as to be within the bounds assigned to *Newtown*, and that he was brother of *Robert Lockwood*, of *Watertown*, who was executor of his estate. This supposition is favored by the fact, 1st, that on the 31st of March, 1631 (before *New Town* was planted), he was a surety for *Nicholas Knapp*, of *Watertown*. 2dly. On the 7th of April, 1635, the General Court referred to the church of *Watertown*, with the consent of *Robert Lockwood*, exec'r of *Edmund Lockwood*, deceased, to dispose of the elder children of said *E. L.*, and the estate given to them, at their discretion; to take account of the said *Robert Lockwood*, and give him a full discharge. It is probable that he had two wives, the first of whom was mother of "the elder children," assigned to the care of *Wat. Church*. His 2d wife was *Elizabeth*, dr. of *John Masters*, of *Wat.*, by whom he had a son *John*, b. in *Newtown*, Nov. 1632. After his decease, his wid. *Elizabeth* m. *Cary Latham*, of *Newtown*, who moved to *New London, Conn.*, and by him she had several chil. [See *Caulkins' Hist. N. London*, pp. 87, 306, and 312; also, *Geneal. Reg. II.*, p. 180; *IV.*, p. 62; also, *Hist. of Norwalk, Conn.*, by *Edwin Hale, D.D.*, pp. 184, 203, 218, &c.]

It is probable that all of the name of Lockwood in New England are descended from Robert and Edmund, and there is not much doubt but that there is a misnomer of the widow of Edmund, in the Court Records of Massachusetts Bay, as printed, I. p. 134, and Index.

LONGLEY.—See Crispe, in Part II.

MABERRY.—Mar. 10, 1746-7, Chelmsford cautioned against (settlement of) Richard Maberry, from Wat.

M'OSKRY.—See p. 842, note.

MACKLENNING.—Jan. 18, 1720-1, John Harrington, [17] of Lex., admonished by the Court, for not suitably providing for his servant, "Hugh Macklenning," having lodged him a great part of his time in the barn.

p. 354. **MACOMBER.**—See General Reg. vii., p. 180.

MADDOCK.—[2.] A letter of John Maddock, of Wat., dated Jan. 16, 1698-9, says, that since the last he had a son [Henry], born, named for his grandfather, and it appears that he had an uncle, John Maddock, of Barbadoes, at that time. Admin. was granted to wid. Ruth Maddock, Mar. 1, 1702-3. His inventory was dated Feb. 26, 1702-3. Joseph Child, her 2d husband, by whom she had 3 chil., d. Nov. 3, 1711, and she m. (3d), Thomas Ingersol, of Springfield. The homestead of John Maddock (house and two-thirds acre; in the sale of it to Jonas Bond, called 1 acre), was on the S. side of the river, probably in Newton, bounded E. by highway; S. and W. by Stephen Cook; N. by Samuel Stowell.

[3.] Joseph Chadwick was of Malden in 1731.

[6.] Thomas Ward was of Pomfret, Conn., in 1731.

[7.] Henry Maddock was a tailor, of Wells, in 1731.

[8.] Caleb Maddock was of Pomfret, Conn., in 1732.

[9.] Joanna Maddock m. Edward Oakes, of Medford, in 1731.

[10.] Family records say that John Maddock m. Rebecca Stone [38]; town records say Elizabeth. The last must be erroneous.

MAGINNAH.—Ap. 4, 1682, selectmen of Wat. stated to the Court that Daniel Maginnah, an Irishman, is lately removed from Medford, and hired estate of Richard Houlding, having a poor place, and considerable family of children, and they disapprove of him as an inhabitant. Daniel Maginnah and Rose Neal, m. in Woburn, Feb. 10, 1676-7, and had one or more chil. b. there.

p. 355. **MARCH.**—Mar. 10, 1741-2, Camb. cautioned against (settlement of) William March, and his family, from Wat., he being an enlisted soldier at Castle William, and at the time of enlistment an inhabitant of Watertown.

p. 356. **MASON.**—[1.] Hugh Mason, aged 28, and wife Esther, aged 22, embarked in the Francis, of Ipswich, John Cutting, master, the last of Ap., 1634. Lieut. Hugh Mason was accepted as Captain by the Court, in Ap. 1652. He was, by the General Court, first appointed Commissioner to end small causes in May, 1643; and in May, 1658, upon the request of the inhabitants of Watertown, he was "empowered to solemnize marriages at Watertown." This was very soon after the removal of Elder Richard Browne to Charlestown. Ap. 1658, he was, by the County Court, made one of the committee on the house of correction. Wid. Hester d. May 21, 1692.

[2.] [See p. 720.]

[2.] Elizabeth (2d child), b. Sept. 3, 1638, d. young.

[3. Note.] Hannah Brooks, wit. of a case in Wat., June, 1671, then aged (?) 13, showing her birth to be in 1658.

p. 357. [4.] Chil. of JOHN and ELIZABETH (Hammond) MASON, of Newton. Wife Elizabeth d. 1714.

1. *John*, b. Jan. 22, 1677; of Lexington.
2. *Elizabeth*, b. Nov. 10, 1678; m. *Thomas Brown*, of Boston, Innholder.
3. *Abigail*, b. Dec. 16, 1679; probably d. young, as she is not named in her father's deed to his son Daniel.
4. *Samuel*, b. Jan. 22 or 28, 1688; d. s. p.
5. *Hannah*, b. Jan. 26, 1694; m., July 7, 1721, *Joseph Sabin*, of Rehoboth.
6. *Daniel*, b. Nov. 10, 1698, of Newton; m. in 1717, *Experience Newcomb*. Chil.
 1. Daniel, b. Ap. 10, 1717. [(?) Daniel Mason, of Lex., m. (pub. in Weston, Mar. 14, 1736), Anne Allen [71]].
 2. Samuel, b. Jan. 24, 1720; m., in 1745, Esther Myrick, b. Feb. 27, 1725, dr. of Samuel and Mary (Stratton) Myrick [Myrick, 4]. Chil., 1. Esther, b. July 12, 1746. 2. Elizabeth, and 3. Mary (twins), b. Sept. 25, 1750. 4. Samuel, b. Feb. 15, 1754, d. 1756. 5. Abigail, b. June 2, 1756, m. Dec. 5, 1782, Abijah Stone, [124-4], in Part II.
 3. Abigail, b. Nov. 23, 1721. 4. Hannah, b. Feb. 4, 1724.
 5. John, b. Dec. 23, 1725.
 6. William, b. Nov. 21, 1727; m., in 1750, Hannah Child. Chil.,
 1. Hannah, b. Aug. 4, 1751. 2. William, b. Sept. 23, 1753.
 3. Olive, b. Dec. 2, 1758. [Jackson's Hist. of Newton, p. 364].

[†6.] John and Lydia (Loring) Mason, besides the 5 children named in the text, had 7 others, b. in Lex., not in the town records.

[†8.] Daniel Edes, wife Catherine, and dr. Catherine, moved from Charlestown to Wat. in Ap. or May, 1761. Catherine Edes, and 2 chil., Catherine and Sally, moved from Wat. to Lex., Sept. 1764.

[†15.] Jonas Mason, adm. f. o. Charlestown, Jan. 21, 1727-8.

[†16.] Katherine, m. — Brown, and d. in Holliston, aged 22 yrs. 7 m.

[†18.] SARAH MASON, m., Jan. 3, 1733-4, WILLIAM MUNROE, Jr., of Lex., by whom she had 6 chil. He d. Aug. 18, 1747, and his wid. Sarah, m., Feb. 12, 1747-8, Francis Bowman, of Lex. Chil., by Mr. Munroe.

1. *Edmund*, b. Feb. 2, 1735-6, m., Aug. 31, 1768, *Rebecca Harrington*. [Harrington, †39.] He was an officer in the French War, was a Captain in the Revolution, and was killed in the Battle of Monmouth. His youngest child, Edmund, b. 1775, is now (1853) the oldest printer in Boston.
2. *Sarah*, b. May 1, 1738; m., Dec. 2, 1762, *William Tidd*. It is probable that she d. soon, and that he m. (2d), Jan. 9, 1766, *Ruth*, dr. of Ensign Robert and Anna (Stone) Munroe.
3. *Catherine*, b. Sept. 29, 1740; m., Nov. 22, 1764, Major *Joseph Bowman*, of New Braintree. [See Bowman, 195, p. 696.]
4. *William*, b. Oct. 22 or 28, 1742; was an orderly sergeant in the Battle of Lexington, "was an officer of the Revolution, of great valor," and attained the rank of Colonel. He d. about 1825; had 2 wives and 6 children.
5. *Abigail*, b. Feb. 24, 1744; m. *Daniel Spooner*, Esq., of Hartland, Vt., and d. 1846, aged 102.
6. *Nehemiah*, b. July 1, 1747; m., Ap. 22, 1772, *Avis Hammond* [Hammond, 29-1], and settled in Rox., and d. Aug. 2, 1828.

☞ For more full information respecting this family of Munroes, see Locke Family, App. E., p. 308, &c.

[†194.] For 1726, read 1720. Samuel Mason's wife taught school in Wat. 12 weeks, from Jan. 1, 1767. He had, 1. Samuel, bap. in Wat., Sept. 3, 1758. 2. Elijah, bap. Mar. 1, 1761. 3. Daniel, bap. Aug. 24, 1766. 4. Isaac, bap. Dec. 8, 1768. [Was this the Samuel Mason, above, who m., Sept. 26, 1745, Esther Myrick, of Newton?]

[8.] For 1684-5, read 1683-4. For 1724-5, read 1723-4.

[9.] For May 2, 1685, read May 22, 1684.

[10.] Wid. Hester Johnson, d. Mar. 7, 1654.

[18.] For [24], read [50]. He (N. P.) d. Jan. 24, 1754. His son Hezekiah, d. Feb. 1, 1754.

[20.] For Mar. 3, read Mar. 30. [22.] For Nov. 4, read Nov. 11.

[23.] Susanna, b. Sept. 22, 1729. [24.] For 1722-3, read 1721-2.

p. 359. [46.] For 1781, read 1785.

p. 360. [68.] For John K., read John R.

p. 361. [97.] See Hist. Mendon Asso., p. 301.

p. 362. [100.] For Oct. 16, read Oct. 11. [106.] For 1814, read 1813.

[120.] For Ap. 2, read Ap. 24. His 2d wife was Martha Clark. [Clark, 65.] N. Mason was selectman of Wat., 1770, 71, 72, 73.

- [121.] Son Lewis, b. Feb. 27. Other chil. For Azar, read Azor. For Verlow, read Vanlow, b. 1790. 8. Noble, b. Feb. 9, 1793. 9. Nancy.
- [122.] Besides those 6 named, Hugh Mason had 7 other children, b. in New Marlboro.
- [124.] Joseph, d. early.
- [125.] Moses Mason settled in New Marlboro.
- [126.] Sarah m. James Howland, of Walpole, N. H.
- [131.] Elijah and Sally, had 8. Polly. 9. Elias. 10. Elijah. 11. Almira.
- [133.] For May 4, read May 24.
- [134.] Dr. William Bond Mason, m. Mrs. Lydia (Buckley) Worthington.
- p. 363. [137.] Chil. of Jonathan M., Esq. 1. Sarah, b. Dec. 12, 1782; d. Mar. 9, 1784.
2. Polly. 3. Jonathan, &c.
- [162.] Ebenezer Mason, had 6th child [166½], Seth, b. Feb. 5, 1768; d. aged 18 months.

p. 364. **MASTERS.**—Sept. 3, 1635, John Masters was licensed by the Court to keep an ordinary. He was discharged June 4, 1639, a few months before he died. [See Lockwood, also Tabor, in Part II.]

MAYHEW.—It is probable that Mr. Thomas Mayhew arrived in 1631, as he was chairman of the committee which reported to the Court, Mar. 6, 1631-2, the boundary between Charlestown and Newtown. For the ensuing 13 years, it appears by the Colonial Records, that few, if any, other persons so often received important appointments from the General Court. It would require a large space to enumerate them. He was one of the first Commissioners appointed for Watertown, to end small causes in 1638, and held the office by re-appointment, until 1642. For other town offices, see p. 364. Oct. 10, 1641, James Forett, agent of the Earl of Stirling, granted to Thomas Mayhew, of Watertown, and his son Thomas, Nantucket, and two small islands adjacent; and on the 23d of the same month, he granted to them Martha's Vineyard, and the Elizabeth Islands. Of these, Mr. Mayhew was constituted Governor. [Hutchinson's Hist. I., p. 161.] While in Watertown, he built the first bridge over Charles River, about 1641 (only a foot-bridge); was temporarily proprietor of the Mill, of the fishing-wears, of the Oldham Farm, and of the Bradstreet Farm, in Cambridge Village (now Newton). It is probable that his son, and others with him, went to Martha's Vineyard, soon after the grant was made, and that Mr. Mayhew, Sen., did not move there, until the spring or summer of 1645, as he signed the report of a committee, as chairman, Dec. 7, 1644, which was presented to the Court the next May; and his place on a committee was supplied by another appointment the next October.

On the 14th Oct., 1647, Thomas Paine, son of Thomas Paine, of London, deceased, 15 years old and upwards, chooses Thomas Mayhew, "now of the Vineyard," my father-in-law, and Grace, his wife, my (?) mother-in-law, guardians till 21 years of age, which will be 8th Feb., 1652. It is probable that this was Thomas Mayhew, Jr., and that Jane was the last wife of Thomas, Sen.

MAYNARD.—[3.] Harriet Maynard m., 1829, Caleb S. Wellington.

- MEAD.**—Chil. of David and Hannah (Warren) Mead, of Camb., (Lex.)
1. Hannah, b. Sept. 17, 1676; m., Oct. 14, 1701, Lieut. Ebenezer Locke, his 2d wife. She had 5 chil. [See Locke Fam., p. 21.]
2. David, b. 1678; a constable, of Wat., 1729, and 31; m., 1707-8, Hannah Smith. [See p. 364.]
- p. 365. [12.] Jonathan d. Mar. 24, 1814. 2 of his drs. m. 2 Grangers, a father and his son.
- [19.] Joshua Mead, of Waltham, a son of David [2], was b. in Camb., Mar. 12, 1709-10.
- [21-5.] Jacob was drowned, aged 11 years.
- [24-1.] Strike out this line. See [21-5.]
- p. 366. [31.] Moses Mead, son of David, b. in Camb., Oct. 21, 1711.

MELLEN.—(Melin, Milling, Melling, &c.) The name of this family is spelled so differently in the town, and in the church records, that, through inadvertence, the information contained in them was not combined, as it obviously ought to be.

- 1 | SIMON MELLEN, with wife MARY, moved to Wat., about 1685, with 5 chil., viz.,
- 2 | 1. SIMON, b. in Winesimet, Sept. 25, 1665; bap. in Wat., Dec. 5, 1686; m., Dec. 27, 1688, ELIZABETH FISKE. [J. Fiske, 8.] [For her numerous descendants, see Barry.]
- 3 | 2. THOMAS, b. in Malden, Aug., 1668; bap. in Wat., Oct. 17, 1686, "a young man," adm. f. c. July 31, 1687; of Fram. His son James, m., in Wat., Sept. 29, 1720, Abigail Sanderson. [15.]
- 4 | 3. RICHARD, b. in M., Jan. 2, 1671-2; bap. in Wat., Dec. 5, 1686.
- 5 | 4. MARY, b. —, bap. in Wat., Dec. 5, 1686; m., Dec. 6, 1695, THOMAS GLEASON, of Fram. Numerous chil. and descendants.
- 6 | 5. JAMES, bap. in Wat., Dec. 5, 1686; set 15, in 1696.
- 7 | 6. JOHN, b. in Wat., Jan. 29, 1685-6; bap. in Wat., Dec. 5, 1686.

☞ For much information respecting this Mellen family, which resided only a very few years in Watertown, see Barry, p. 325, &c.

MELVIN.—Dec. 8, 1725, caution against (settlement of) Elizabeth Melvin, alias Elizabeth Mooly, and her child, from Boston, August last.

METHUP.—See Benjamin, 10.

MILLER.—For Sally, read Polly (Mary). THOMAS MILLER, of Waltham, m. (pub-May), 1794, MARY, dr. of William and Mary (Leathers) Frothingham, of Charlestown. Chil.,

- 2 | 1. Maria, b. Mar. 17, 1795; m. *William Hobbs*. Chil., one of whom grad. Harv. Coll.
- 3 | 2. Eliza, b. Mar. 17, 1797; m. — *Merriam*, s. p.
- 4 | 3. Lucinda, b. Sept. 1, 1799.
- 5 | 4. *Thomas Frothingham*, b. June 20, 1802; m., and many children.
- 6 | 5. *Isaac*, b. Aug. 13, 1805.
- 7 | 6. *William*, bap. Aug. 7, 1808; m., and has children.
- 8 | 7. *Ruth Frothingham*, b. Ap. 9, 1814. 8. *George* (the forger), m., and has children.
- 10 | 9. *Mary*, unm. 10. *Martha*, m.

p. 367. **MILLS.**—Dec. 30, 1701, Joseph Grant, glazier, and wife Mary, Caleb Grant, mason, and wife Elizabeth, and Henry Mills, carter, of Boston, sold to Nathaniel Whitney [63], 12 acres in Watertown. Jan. 28, 1702-3, Caleb Grant and wife Elizabeth, sold 6 A. of land in Wat., to Henry Mills, of Boston. Ann (? Jane) Mills, late of Wat., by her Will, dated Nov. 7, 1725, gave one-quarter part of her estate to the Church in the west part of Wat. [Waltham], to be laid out in four years for the relief of the poor of the church. Inventory, £18 per annum. Ex'rs, Dea. N. Fiske, and Jonathan Stone; trustees, Thomas Bigelow, Daniel Benjamin, and Allen Flagg.

MIXER.—[1.] Isaac Mixer was selectman, 1651 and 55. Ap. 1, 1651, he was appointed by the County Court, sealer of weights and measures. His Will was proved June 19, 1655. He owned $\frac{1}{2}$ of the vessel Diligent, then at sea, whereof John Shepherd, under God, was master. His share of it was appraised at £25. His Inventory, dated June 19, 1655, embraced, besides his homestall, 12 parcels of land, amounting to 180 acres. His homestall of 6 acres, in 1642, where he probably first settled, was bounded E. by William Jennison; W. by highway; N. by Miles Nutt; S. by John Whitney and John Spring.

[3.] For [Collidge, 2], read [Coolidge, 2]. He m. (3d), June 29, 1687, Mary, &c. Isaac, Jr., was selectman many times, 1673 to 1701, and Town Clerk, 1692.

[6.] REBECCA, m., Nov. 23, 1683, SAMUEL KENDALL. She d. Oct. 25, 1691, leaving four chil. [He m. (2d), Mar. 30, 1692, MARY LOCKE. See Locke Fam., p. 20.] Chil.,

1. Samuel, b. July 13, 1684. 2. Isaac, b. Sept. 13, 1686.

3. Joshua, b. Mar. 14, 1688-9 [see p. 325.] 4. Rebecca, b. June 6, 1691.

[7.] May 2, 1698, Isaac Mixer [3.] and wife Mary, sold to son Isaac Mixer, 18 A.

plowland, in the Great Plain, bounded E. by Haward's [? Hayward's] land; W. by John Cutting; N. by Sud. Road; S. by Charles River. [This was a part of "Waltham Plain."] Nov. 2, 1698, same sold to same, 16 A. meadow, bounded E. by Joseph Whitney; W. by Robert Harrington; N. by 4 mile brook.

- [19.] May 2, 1698, Isaac Mixer [3] executed two deeds of gift to his son, John Mixer, a tanner. 1st. 70 acres, bounded E. and S. by Robert Harrington; W. by Thomas Woolson; S. by Ephraim Cutter; N., by Capt. Warren. 2d. 18 acres, bounded E. by Joseph Whitney; W. and N. by Robert Harrington; S. by 4 mile brook. Both lots in Weston.
- p. 368. [25.] Dea. Joseph Mixer was treasurer of the W. Precinct, 1721-22. Mar. 2, 1700, Isaac Mixer [3] and wife Mary, for £60, sold to son Joseph 3 parcels of land, viz., 30 A. in Wat.; another of 70 A., and one-half of another of 14 A.
- [46.] Jan. 10, 1701-2, Benjamin Mixer, of Wat., bought 20 acres in Marlboro, of Isaac How, of Marlboro. In 1711, he was one of Capt. Brigham's garrison in Marlboro. [Wor. Mag. II., p. 154.]
- p. 369. [80.] Jason Mixer, Esq., d. Jan. 31, 1850. His chil. were, 1. William. 2. Charles. 3. Susan. 4. George. 5. Mary Ann.
- [†85.] Sarah, m. Samuel Pope, of New Braintree.
- [†86.] Joseph Green was of New Braintree.

- p. 371. **MORSE.**—[1.] For Deborah Morse, read Dorothy. Joseph Morse, Sen., of Ipswich, had "died lately," Sept. 29, 1646, leaving wid. Dorothy, and chil. Joseph, Hannah, and John. His son Joseph settled in Watertown, as in the text. His son John was a proprietor of Ipswich in 1638, and his name is found in the Ipswich records of 1663. He (or another John) had Elizabeth, b. in Ipswich, Mar. 29, 1657, d. June 7, 1659. Mary, b. June 15, 1661. He was an original proprietor of Groton, and was the town clerk 1669 to 1684. The "young John Morse, formerly of Groton" [see p. 374], was probably his son, and he m. in Wat., Mar. 5, 1686, Dinah Knight, b. July 4, 1660, dr. of Joseph Knight, of Woburn. [See Memorial of Morses, App. lxxiii.]
- [2.] For Feb. 11, 1660-1, read Ap. 12, 1661.
- p. 372. [16.] For 1660, read 1666 John Morse was selectman 1693, 4, 6, 7, 8. He was designated as ensign before he was elected deacon. Aug. 10, 1702, admin. was granted to his son James, who was at the same time appointed guardian of his brother Nathaniel, aged about 14 yrs. Inventory, dated Aug. 5, 1702, real estate, £202 14s. Agreement of his chil., Aug. 5, 1702, viz., sons James, John, Joseph, Nathaniel, John Parkhurst, and Abigail, his wife. [Had Dea. John Morse a 3d wife, Sarah?—Feb. 24, 1698-9, John Morse, of Wat., and wife Sarah, for £35, sold 10 lots of land in Wat. to Joseph Parkham, of Chelmsford.]
- p. 373. [34.] Inventory of Joseph Morse, Aug. 12, 1709, house and 12 A. £60. Admin. granted to his wid. Elizabeth, Sept. 5, 1710.
- [53.] For [Shattuck, 48] read [50]. For App. 1, xxx. read lxxiii. June 1, 1702, admin. granted to wid. Sarah Morse, upon the estate of her late husband, John Morse. Sureties, Thomas Lord and Nathaniel Lord, both of Charlestown.
- David Morse (?), son of "young John Morse," m., 1706, Mary —
- [65.] Dec. 31, 1707, Joseph Morse, of Wat., heretofore preacher of the Gospel in the W. Precinct, and wife Amity, sold to a committee of the town all his land, as heretofore conveyed.

MUNNINGS.—Inventory of George Munnings, dated Sept. 21, 1658, goods, £16 19s. Debts due to him £239 14s. Among the items, was one cow, in Watertown, in the hands of — Hyde. He m., for his 2d wife, Johanna, wid. of Simon Boyer. Inventory dated Sept. 21, 1658, of goods that were Simon Boyer's, and are now Johanna Munnings', which she had before her marriage with said Munnings, £25 0s. 1d. George Munnings, of Boston, was one of the executors and legatees of Robert Saltonstall, in 1650. [See General. Reg. vii., p. 334.] Nov. 15, 1637, George "Munnings, of Watertown, is [by the Court] put down from keeping an ordinary, or house of entertainment, and it is referred to Watertown to choose another." May 6, 1646, ordered by the Gen. Court, that George Munnings shall be allowed £15 per annum, besides the fees, for his services as "keeper of the countrie's prison, and he shall be freed from executing public correction and execution." He continued to be prison-keeper of Boston until after Nov. 1654. Oct. 7, 1646, the Gen. Court appointed Mr. Aspinwall and George Munnings, to lay out land granted to Capt. Jennison, Richard Brown, Robert Keayne, and others.

MYRICK.—[1.] John Myrick, of Newton, was killed by Indians, in Groton, July 21, 1706. [See Butler, p. 96.]

p. 375. [4.] It is probable that the 2d marriage was that of his son, Samuel, Jr.

Chil. of SAMUEL and MARY (Stratton) MYRICK, b. in Newton :

1. *Samuel*, b. Ap. 21, 1719, (?) m., 1741, *Hannah Coolidge* [? 82-2].

1. *Abigail*, b. Feb. 10, 1742, d. 1744.

2. *Mury*, b. Feb. 15, 1721. 3. *Sarah*, b. 1722.

4. *Esther*, b. Feb. 27, 1724. 5. *Anna*, b. Aug. 2, 1729.

6. *Elizabeth*, b. Mar. 1732. 7. *Abigail*, b. Dec. 23, 1734.

8. *Hannah*, b. Sept. 17, 1736. 9. *Lydia*, b. Jan. 7, 1740.

[6.] One record says John was b. Jan. 30, 1694.

[20.] One record says James was b. Jan. 9, 1692.

[27.] Josiah m. wid. Ruth (Upham) Norcross [Norcross, 26].

[28.] Elizabeth m., Nov. 1716, Benoni Woodward.

[30.] Lydia m., Aug. 31, 1732, James Cheeney.

NEVINSON.—Ap. 6, 1686, John Nevinson, of Wat., and wife Elizabeth, for £120, sold house and 100 acres, to Andrew Belcher, of Charlestown. Ap. 11, 1692, John Sharpe, of Camb., and wife Elizabeth, for £46, sold to Andrew Belcher a house and 12 acres, near Palgrave Wellington and Michael Barstow. Nov. 23, 1695, Andrew Belcher and wife Hannah granted the same to William Nevinson [6], as in the text. Abstract of the Will of wid. Elizabeth Bond: Daughters Mary Hastings and Sarah Livermore, and gr. dr. Elizabeth Hastings, to have her wearing-apparel and books. To dr. Mary, £26, "in consideration of her living with me." To gr. son, William Grant, a bed, and articles of furniture. To son-in-law Samuel Hastings, 5s. To son-in-law, Joshua Grant, 5s. To gr. son [gr. grandson] Moses Hastings, 12s., to buy him a silver spoon. To grandson John Hastings' two drs., Mary and Anne, a silver spoon each. Gr. son, Samuel Hastings, £5. To "gr. dr. Elizabeth Hastings, aforesaid," £5. Residue equally to "abovenamed drs., Mary Hastings, Sarah Livermore, Elizabeth Hastings, Samuel Hastings, and William Grant." Drs. Mary Hastings and Sarah Livermore, exec'rs.

Chil. of JOHN and ELIZABETH NEVINSON.

2] 1. **MARY**, b. 1668; birth not recorded; d. 1732, aged 64; m. **NATHANIEL HASTINGS** [6]. 2 chil. She lived in widowhood 38 yrs.

3] 2. **JOHN**, birth not recorded; d. Feb. 23, 1691-2, unm.

4] 3. **SARAH**, b. July 22, 1672; m. (1st), **NATHANIEL STEARNS**, his 2d wife [I. Stearns, 38, III.]. He d. Aug. 24, 1716, and she m. (2d), Ap. 24, 1718, **SAMUEL LIVERMORE**, s. p. [Livermore, 48]. She m. (3d), Ap. 8, 1722, **HON. EBENEZER STONE** [39]. She d. 1741.

5] 4. **ELIZABETH**, b. Oct. 22, 1675; m., Ap. 24, 1695, **SAMUEL HASTINGS** [23], his 2d wife. She d. early, leaving three chil., one of whom, Benjamin, d. in childhood. [See [23], p. 789.]

6] 5. **ANNA**, b. Oct. 2, 1678; m., Aug. 30, 1716, **JOSHUA GRANT** [17]. She d. in childhood, June 24, 1717, leaving son William.

7] 6. **WILLIAM**, b. June 26, 1681, d. 1711, unm., and his mother, Elizabeth Bond, admin'x [see p. 376].

NISBET.—See p. 842, note.

NORCROSS.—[1.] Last line but one, for Sarah, read, dr. Sarah. The Will of Jeremiah Norcross, dated Sept. 15, 1654, proved Oct. 6, 1657. He gave 20s. to ministers Sherman, Simes, Watson, Eliot, and Mather. His Inventory was proved by his son Richard, Oct. 5, 1658. In Court, Oct. 6, 1657, Dea. Simon Stone, and Charles Chadwick, testified that Mr. Norcross, deceased, declared his Will before he went to England. This implies that he died in England.

[2.] The name of Nathaniel Norcross, is the first on the list of petitioners (May, 1644), for a plantation at Nashaway.

[3.] The Will of R. Norcross, mentions sons Richard, Samuel, Jeremiah, dr. Mary, 6 grandchil., the chil. of his daughter [Sarah] Child. In the Inventory, dated Oct. 14,

1709, is mentioned widow Mary. On the files of court for 1679, is the petition of Richard Norcross, for 20 years schoolmaster, that the privilege of exemption from training may be conferred on him, who is called [again] to the same employment, [then aged 58]. He was schoolmaster at least 49 years.

- p. 377. [4 and 7.] Jan. 31, 1709-10, Jeremiah Norcross and Mary Norcross, semster (spinster), sold to Joseph Child, 19 acres, late of Richard Norcross, d., bounded N. and W. by Capt. N. Barsham; S. by Charles River; E. by land of J. and M. Norcross. Also 1 acre of marsh, E. of the above, on Charles River.

[9.] For 1771, read 1671.

[13-3.] Sarah Norcross m., Jan. 3, 1760, Ephraim Peirce [214].

[18.] Nathaniel Norcross, m. (2d) Susanna Shattuck [18]. She d. in Sudbury, Feb. 15, 1711-12. Mar. 15, 1692-3, Nathaniel Norcross, cordwainer, of Wat., for £23, sold to Michael Homer, of Boston, 12 acres, bought of — Moss, and Mar. 28, 1688, 12 acres in lieu of township.

[19.] Mehitabel Norcross m. Daniel Livermore [39].

- p. 378. [32.] See Abbott, part ii. Nathaniel Norcross, d. Ap. 19, 1749.

[33.] Nathaniel Norcross d. at sea, Aug. 5, 1744.

[39.] Nehemiah Norcross, of Charlestown, in 1773, and in Ap., 1775, lived very near the meeting-house.

[41.] In Nov., 1720, Philip Norcross bought the ancient house, with 7 acres of land, supposed to have been built by Richard Park, Sen., which stood within 100 feet of the site of the present Elliot meeting-house. He d. Jan. 18, 1748, aged 50. Inventory, house, barn, shop, and 14 acres, £1659 15s. His wid. Sarah, d. in 1754.

[42.] Grace Norcross m., in 1744, Gershom Hyde. 6 chil. [See Jackson, p. 323.]

[43.] Thankful (Norcross) Spring, m. (2d), in 1782, Joseph Adams.

[44.] Samuel Norcross m., in Newton, in 1751, Mary Wiswall. He moved to Camb., probably about 1758. Chil.,

1. Samuel, b. in Newton, Dec. 23, 1752. 2. Philip, b. in N., Mar. 16, 1754.

3. Mary, b. in N., Sept. 24, 1755. 4. Elijah, b. in N., Feb. 16, 1757.

5. Josiah. 6. Daniel, bap. Mar. 8, 1761, by Rev. Jacob Cushing.

[45.] Perhaps this Relief, should be Philip.

[50.] This marriage and family, belong to Nathaniel [54]. For Ann Winchester, read Fanny Winchester, b. Mar. 4, 1768, dr. of Stephen W., by his 1st wife.

[50-5.] James W. Norcross, of Newton, m., in 1816, Esther Clark, (?) dr. of Norman Clark, Jr. 11 chil. [See Jackson, p. 373.]

[53.] Josiah Norcross m. (2), in Newton, in 1798, Elizabeth (Betsey) Corkham.

- p. 379. [59.] Moses Norcross m., May 7, 1799, Mary Winchester, b. Mar. 24, 1770, dr. of Stephen and Hannah (Hastings) Winchester, and sister of his brother Nathaniel's wife [see above [50], and page 378]. He settled in Northboro. Chil., 1. Mary. 2. Ermina. 3. Stephen Winchester. 4. Fanny Winchester. 5. Harriet.

- p. 380. [80.] Charles M. Fogg, Esq., d. Dec. 9, 1854, aged 49.

NUTTING.—[3.] Aug. 26, 1740, Watertown entered caution against (settlement of) Samuel Nutting, and 4 children. Elizabeth Nutting [2.], was probably his dr., b. before he came to Watertown. His son John [4.], was probably the John, "a young man," who went to Charlestown, in June, 1766. [8.] Samuel Nutting m. (2d), in Groton, Oct. 9, 1765, Olive Ames.

OFLEY.—For John Ofley, read David. This name was sometimes written Osley, David Ofley, mem. Art. Co., 1638.

OLDHAM.—For Simon Bradstol, read Bradstreet. Mr. Bradstreet was never proprietor of "the Oldham Farm."* The 500 acres, which Mr. Mayhew conveyed to Mr. Bradstreet, were on the south side of Charles River, in Newton. [See Map, in Jackson's Hist. of Newton.] For Black (Island), read Block.

* The General Court granted the "Oldham farm" to Mr. Oldham, Ap. 1, 1634. He mortgaged this grant (which was not ordered to be laid out until June 2, 1641, sometime after his decease) to Mr. Cradock; Mr. Cradock sold it to Thomas Mayhew, subject to a mortgage. Mar. 18, 1647-8, Nicholas Davidson, of Charlestown, atty of Rebecca Cradock, alias Glover, sold it (cancelled the mortgage) to Thomas Mayhew, for 1000 acres in Martha's Vineyard. Soon after this, it was seized by virtue of execution granted to Richard Dummer, against Mayhew. The land was appraised Mar. 21, 1648-9, at £70, and was to be measured out at the charge of Mr. Mayhew. In a few instances, in the records, it is called "the Dummer Farm."

Mr. John Oldham arrived at Plymouth, in the ship *Ann*, in July, 1623. That he was a man of comparative wealth and importance, may be inferred from the fact, that in the allotments in Plymouth, in 1624 (the first ever allotted "in continuance"), ten acres were assigned to him, which was a considerably larger lot than any other person received. The next largest, 7 acres, was that of Mr. Allerton. All the others, including those of Gov. Bradford, and Elder Brewster, were still less. It is supposed that besides wife and children, he had servants, which entitled him to so large a lot. We may also infer his good repute and respectable social rank from the circumstance, that the Governor invited him, so soon after his arrival, to a seat in his council.

Morton says [Memorial, p. 122], "Mr. Oldham was a man of parts, but high-spirited and extremely passionate, which marred all in right improvement of them." The next spring, soon after the arrival of Mr. Lyford in Plymouth, he and Oldham became intimately associated together, and by their perverse conduct, gave so much disquietude to Plymouth, that in the summer of 1624, Oldham was banished, with orders to depart immediately, and forbidden ever to return; but his wife and family had "leave to stay the winter, or till he can make provision to move them comfortably." He went to Nantasket, probably accompanied by the worthy Mr. Roger Conant, and not long after was followed thither by Mr. Lyford. The next April, 1625, Mr. Oldham returned to Plymouth, without leave (perhaps for his family), and, says Morton, "suffered his unruly passion to run beyond the bounds and limits of all reason and modesty," so that he was again expelled immediately, with the greatest indignity.

The great offence of these three gentlemen and their adherents, was their attachment to Episcopacy, and a man of Mr. Oldham's talents and temperament was not likely to maintain a controversy with the authorities of Plymouth in an inoffensive tone, especially when he coincided in sentiment with a majority of Plymouth Company, in England. These circumstances are to be remembered, when reading the opprobrious disparaging language of Bradford, Morton, and others.

In 1624, the Dorchester adventurers began a settlement at Cape Ann, and having heard that "some religious persons removed from Plymouth to Nantasket, from dislike of their rigid principles," in 1625 they chose Mr. Conant to manage their affairs of planting and fishing (i. e., to be Governor), "Mr. Oldham to manage the trade with the natives," and "Mr. Lyford to be minister of the plantation." After remaining at Nantasket more than a year, Conant, Lyford, and others, removed to Cape Ann, in the autumn of 1625, but Mr. Oldham did not accept the appointment, choosing to "stay at Nantasket, and trade for himself."

- In 1626, about a year after being driven a second time from Plymouth, Mr. Oldham entered upon a voyage to Virginia, was wrecked on Cape Cod, and his life was in extreme peril. This was supposed to have led to a change in his character; certainly he gave such evidence of it, as to regain the favor and confidence of the Colony he had so much offended. They gave him "liberty to come and converse with us [of Plymouth] at his pleasure;" and in 1628, they intrusted to him the charge of Morton, the Merry Mount rioter, to transport him to England. Gov. Bradford, in his letter, written on this occasion, says, "this bearer, Mr. John Oldham, who can give your honors further information upon his oath, if need so require, whom we have sent with the prisoner, and to attend to your lordships' pleasure."

While Mr. Oldham was in England, he and John Dorrell purchased, of John Gorges, younger brother and heir of Capt. Robert Gorges, a tract of land, extending from Charles River to Abousett [Saugus] River, and from the border of the bay at the mouth of Charles River, 5 miles into the country, and from the mouth of Abousett River 3 miles into the country. This tract of land seems to be a part of that which John Gorges sold to Sir William Brereton on the 10th of Jan., 1629, and about which Mr. Oldham and Sir William were both negotiating with the Massachusetts Company in the spring of 1629. It is not easy to explain these apparently overlapping titles, from the records of the Massachusetts Company in their letter of instructions to Gov. Endicott. Neither is it apparent how the grant of the Plymouth Company to Capt. Robert Gorges on the 22d of Dec., 1622, became so invalidated or annulled that the same Company could afterwards rightfully grant the same to the Massachusetts Company. The negotiations in 1629, between the latter Company and Sir William Brereton and Mr. Oldham, show that the titles of these gentlemen from John Gorges had at least some apparent validity; but how the conflicting claims were adjusted has not been ascertained. There is, however, good reason to conjecture, that the greater power of the Company, and their legal astuteness, had much to do in this adjustment, if such it would be called, and that the old adage was verified, *might makes right*.

Gov. Cradock, in his first letter of instructions to Gov. Endicott, dated Ap. 17, 1629, after mentioning the troubles occasioned by Mr. Oldham's claim, says, "And because we would not omit to do anything which might strengthen our right, we would have you (as soon as these ships, or any of them, arrive, whereby you may have men to do it), send forty or fifty persons to Massachusetts Bay, to inhabit there; which we pray you not to protract, but to do with all speed, &c., whereby the better to strengthen our possession there against all or any that shall intrude upon us, which we would not have you by any means to give way unto."

The conclusion of this letter is remarkable. After stating fully the extent of Mr. Oldham's grant, and that William Blaxton, clerk, and William Jeffreys, agent, were authorized to put Mr. Oldham in possession, he says, "Having a sight of his grant, this I found, though I hold it void in law, yet, his claim being to this, *you may, in your discretion, prevent him, by causing some to take possession of the chief part thereof.*" In the summer of 1629, in accordance with this direction, Gov. Endicott sent a few settlers to take possession of Charlestown, which was nearly the central point of Mr. Oldham's grant. There is nothing, either in the two general letters of instructions of the Massachusetts Bay Company to Governor Endicott, or in the records of that Company, that exhibits Mr. Oldham as anything less than a frank, highminded man, confident of the justice of his claim.

Mr. Oldham is said to have returned to America in 1629; but we find no mention of him in any records until he was admitted freeman, May 18, 1631, the earliest date of any such admission. The precise date of his settlement in Watertown has not been ascertained, but it must have been very early, if not coeval with the first planting thereof. It is evident that a more truly catholic spirit, and more just ideas of civil and religious liberty prevailed among the first settlers of Watertown, than in either of the other very early plantations about the Bay. As evidence of this, we may refer to Winthrop for the accusation against Elder Richard Browne, the treatment he received, and the ground assumed by Mr. Phillips; also, the arraignment and trial of Rev. George Phillips, Elder Richard Browne, and others, of Watertown, for expressing their opinions respecting representation and taxation; also, to the arraignment, a little later, of Capt. William Jennison, for expressing privately his opinion about the course pursued by the British Parliament; also, to that admirable letter of Sir Richard Saltonstall, the founder of Watertown, to the ministers of Boston, on account of their "tyranny and oppression,—fining, whipping, and imprisoning men for their consciences." These things enable us to understand why Mr. Phillips, a man of such fully acknowledged talents, learning, and piety, is found to have had little or nothing to do with the illiberal politico-ecclesiastical policy of that day, and why the high-spirited John Oldham should attach himself to the Watertown people, who, at the earliest opportunity, manifested their respect and confidence by conferring on him their most important political trusts.

But the respect entertained for Mr. Oldham, and the confidence in his talents and integrity, were not confined to the Watertown people. In May, 1632, soon after the notable resistance of the Watertown people to taxation without representation, and before the institution of a body of deputies or representatives, it was ordered by the General Court, "that there should be two of every plantation appointed to confer with the Court about raising of a public stock," that is, the levying taxes for public uses. These appointments were made by the Court, and the first name on the list of appointments was that of Mr. Oldham. He was a member of the first meeting of deputies of the several plantations in Massachusetts Bay, in May, 1634, and he was made chairman of the first committee appointed by that Court, viz., to draw a plot for the enlargement of Boston at Mount Woolliston. In Sept. 1634, the Court appointed him "overseer of the powder and shot, and all other ammunition" for the plantations of Watertown and Medford. At the same Court, he was made chairman of a committee (consisting of nine honored names), with "power to set out the bounds of all towns not yet set out, or in difference betwixt any town." He was not afterwards elected deputy, probably on account of his intended removal to Connecticut. But in May, 1635, although not deputy, he was one of the committee appointed to consider and report upon "the act of Mr. Endicott, in defacing the [king's] colors." This subject was brought before the Court of Assistants, "in the name of the rest of the freemen, upon complaint made by Elder Richard Browne, of Watertown, who argued the offence as a matter of an high nature."

There is reason to believe that Mr. Oldham is entitled to the honor of being the pioneer, the projector of the first plantation on the Connecticut, or in that state. Winthrop says

[L., p. 111], "John Oldham, and three with him, went overland to Connecticut, to trade," lodging at Indian towns all the way. The date of his departure is not given, but Mr. Oldham brought back so favorable a report, that in Sept., 1633, a bark was sent thither to trade. Whether Mr. Oldham went in her, it is not stated, but it is very probable; for Winthrop says, Nov. 5, 1634, "the Rebecka came from Narragansett with five hundred bushels of corn, given to Mr. John Oldham. The Indians had promised him one thousand bushels, but their store fell out less than they expected. Canonicus gave him also an island in Narragansett Bay, called Chippacursett [? Prudence Island, said by Roger Williams to be "spectacle-wise"], containing about one thousand acres, six miles long and two miles broad." [See Mass. Hist. Col., 3d ser. I., p. 165.]

In May, 1634, the people of Cambridge (Newtown), obtained permission of the Court "to seek out some convenient place . . . to which they may remove their habitations." The next Sept. they asked leave to remove to Connecticut River, whither they were probably induced to go by the favorable report of Mr. Oldham. This application met with strong opposition from the Assistants, because they proposed to remove beyond their jurisdiction; and such inducements were offered for the relinquishment of their proposed removal, that Mr. Hooker and his company did not migrate to Connecticut until May, 1636, when they commenced the settlement of Hartford. It is said that, in their first project for a removal, it was their intention to settle on the beautiful meadows of Pyquag. In the meantime, during their delay, Mr. Oldham and a company of his fellow-townsmen, took possession of Pyquag, and named it Watertown, which name it retained until Feb. 21, 1636-7, when the Court named it Wethersfield. It is said that a party of Watertown men went to Pyquag in 1634, and remained there with much danger and suffering during the ensuing winter. The next spring, May 6, 1635, the Court granted "liberty to the inhabitants of Watertown to remove to any place they shall think meet to make choice of, provided they shall continue under this jurisdiction." Very soon, and without strict regard to this proviso, they went and settled at Pyquag.

Although Winthrop (July 20, 1636), noticing the death of Mr. Oldham, calls him "a member of Watertown congregation," there is little doubt but that he was one of the colony that went and planted Pyquag. The settlement of his estate is the earliest one to be found in the Connecticut Court Records, and his Inventory was presented to a Court held at Watertown (Wethersfield) Sept. 1, 1636. At the same time, the Court ordered, "that Thurston Raynor [of Wethersfield], as he hath hitherto done, so shall continue to look to and preserve the corn of Mr. Oldham, and shall inn [gather in] the same in a seasonable time." This shows that he was a *planter* of Wethersfield, and probably went there in 1635. [See The Public Records of the Colony of Connecticut, Vol. I., Index.] He left his business unsettled in Massachusetts Bay; for on the 6th Sept., 1636, the Court "ordered that Mr. [Gov.] Haynes, Mr. Harlakenden, and Increase Nowell, or any two of them, should examine business concerning Mr. Oldham's estate and debts, and Mr. Hutchinson and Mr. Mayhew to gather up the debts and estate, and be accountable to the Court."

Mr. Oldham had a family at Plymouth in 1624, but no later reference to it has been discovered. As, however, he had a house in Watertown, near the wear, burnt, Aug. 14, 1632, probably he had a family there. Whether the following named youths were his sons, or otherwise akin to him, has not been ascertained. John Oldham, aged 12 years, and Thomas Oldham, aged 10 years, embarked for New England, May 14, 1635, in the Elizabeth and Ann, Roger Cooper, master. There were families of the name of Oldham in Cambridge for many years afterwards, of whom we have obtained no satisfactory record or information. [See Saltonstall, 35, in Part II., note.]

p. 382. **ONGE.**—Mar. 5, 1630-1, arrived at Nantasket, sailed from Bristol, Dec. 1st, the ship Lyon, William Pierce, master, among whose passengers was — Ong, with wife and children. It is probable that he d. soon, and that his wife was wid. Frances Ong, of Watertown [Winthrop, I., p. 42]. Jacob Ong was "an original proprietor" of Groton; but it does not appear, from the History of Groton, that he had any family there.

OZMENT.—(?Osmer, Hosmer, Osburn.) July 12, 1726, caution against (settlement of) William Osburn or Ozment, from Cambridge.

- p. 383. **PAGE.**—[1.] Testimony in Court, 1678, by James Knapp, aged 53 yrs., concerning the estate of John Page: that about 27 years ago he worked with John Page, Sen., and John Page, Jr., at Piscataqua. John Hamant (Hammond), aged 50, also a witness, when Page is called his uncle.
- [2.] For Dec. 16, read Dec. 6. Feb. 13, 1664-5, wid. Hannah Page sold land to Rev. John Sherman. Nov. 16, 1665, wid. Hannah Page made a marriage contract with Nicholas Wood, of Boggestow (Sherburne), John Coolidge, Sen., and Henry Bright, trustees. May 22, 1674, suit by John Coolidge, Sen., and Dea. Henry Bright, feoffees of Wid. Annah Woods, vs. John Thurston, of Meadfield.
- [4.] For adm. freeman, read, took oath of fidelity. John Page was selectman of Wat. 1695, 96, 97, 98. He had a son Joseph, whose birth is not recorded. Mar. 25, 1710, John Page conveyed to Samuel Phipps, of Charlestown, for the use of his wife Emery, 26 acres in Watertown. Mar. 14, 1710-11, John Page, and wife Emery, sold land in Groton to son John Page, of Groton. He must have died soon after this. Nov. 15, 1711, Emery Page, of Wat., quitclaimed to son Joseph all estate of her husband, John, deceased. On the same day, Joseph "Paige," of Wat., sold to Daniel Harrington two lots of land in Watertown.
- [9.] Sept. 27, 1670, Samuel Page, of Wat., planter, and wife Hannah, for £32, sold to Benjamin Garfield about 23 acres, bounded W. by Edward Garfield, the highway, and John Page; N. by Thomas Smith; E. by William Knapp, Thomas Straite, and Beaver Brook Meadows, with the brook southerly; S. by John Page, Sen., and highway. Oct. 11, 1676, Samuel Page bought of David Fiske, and wife Seaborn, 149 acres in Wat. (Farms), granted to my father, David Fiske; the 9th lot. He probably moved to Wat. Farms about this date.
- [11.] Samuel Page, at the same time (1713) sold land to Nathaniel Lawrence, then of Charlestown.
- [12.] For May 5, read May 15.
- [13.] Caution of Wat., against (settlement of) Thomas Ingram, wife and family, from Weston, July 8, 1709.

- p. 384. **PAINE.**—Embarked, Ap., 1635, in the Increase, Robert Lea, master, William Payne, aged 37, husbandman; Ann Payne, aged 40; Susan Payne, aged 11 years; Wm. Payne, aged 10 yrs.; Anna Payne, aged 5 yrs.; John Payne, aged 3 years; Daniel Payne, aged 8 weeks. After (£1500), insert, to the three children of Samuel Appleton. It is probable that John d. unm., and that the only descendants of William Paine, of Wat., are in the line of his dr. Hannah (Anna) Appleton. Nathaniel Payne, of Rehoboth. [See Whitaker.]

PALMER.—William Palmer, "a townsman, inhabiting" Wat., 1636-7, moved to Newbury, about 1637, thence to Piscataqua (Portsmouth), and afterwards to Hampton. He was one of the petitioners, Sept., 1638, for liberty to begin a plantation at Winnacunnet (Hampton). He d., leaving three sons, Edward, Christopher, and Stephen; dr. Martha, wife of Capt. John Sherman, of Watertown. He married Grace, wid. of Thomas Rogers, who d. in Wat., Nov. 12, 1638. His sons, above named, were by a former wife, and are not mentioned in the Will of his wid. Grace; and Martha, wife of Capt. John Sherman, must have been her step-daughter. After his decease, she returned to Watertown, and m. (3d), Roger Porter. Elizabeth, wife of Daniel Smith [200], was a dr. by her 1st husband, Thomas Rogers. [See Colonial Records, vol. iv., p. 232.]

About 1650, William Palmer, of Hampton, agreed to release to his son-in-law, John Sherman, of Watertown, land in Great Ormsby, Co. Norfolk, England. Probably he came from that place. There was a William Palmer, who arrived at Plymouth, in the Fortune, Nov. 9, 1621. [Chronicles of Plymouth, p. 235.] In Palmer, 3d line, for Nov. 19, 1697, read 1679.

PARILL.—The Inventory of Edward Parill, of Wat., dated June 24, 1644. [See Geneal. Reg., viii., p. 56.]

- p. 384. **PARK.**—(Parke, Parks). The situation of the large Park Farm in Newton, in relation to Watertown, accounts for the numerous alliances between the family and

descendants of Richard Park, and Watertown families. For this reason, and from having discovered some errors, and many deficiencies, in what has been printed on pp. 384, &c., we insert the following corrected record. For more full and precise information, see Jackson's History of Newton, to which we are chiefly indebted for our materials.

The farm of Richard Park, Sen., was contiguous to the small parcel of land, belonging to Watertown, on the south side of Charles River; and it is probable, that his residence was, at an early date, within the bounds of Watertown. Oct. 19, 1652, he was debtor to the ministry of Watertown, £2; and on the 22d Aug., 1659, the selectman ordered that Richard Parks and wife, be not allowed abiding in the town [town record]. May, 1664, he sold to James Keebe, a horse, valued at £6, for which he was to build a frame house. Ap. 3, 1666, Hugh Mason, Thomas Wiswall, and Edward Jackson, were appointed to set off the portion of Sarah, wid. of Richard Park, his second wife, and not the mother of his children. Love Brewster, of Dux., the eldest of the surviving sons of Elder William Brewster, first of Plymouth, afterwards of Duxbury, m., May 15, 1634, Sarah Collier, dr. of William and Jane C., of D. 3 Chil. He d. (?) 1650 (Will dated Oct. 1, 1650), and his wid. Sarah, m. Richard Park. After his decease, she returned to Duxbury. Dec. 4, 1671, she brought a suit against Thomas Park, and Sept. 26, 1678, she, then of Duxbury, for £45 15s., sold Thomas Park her life-estate in the estate of Richard Park.

[1.] Thomas Park was a witness in Court, June, 1679, then aged 50, showing that he was born 1629. He d. Aug. 11, 1690, aged about 62. His estate was divided Oct. 3, 1691, and the following children are named (Thomas having died about five weeks before), viz., John (eldest), Richard, Edward, Jonathan, Abigail Fiske, Sarah Knapp, Rebecca Sanger, Elizabeth Park.

[2.] Thomas, b. Nov. 2, 1654; d. Aug. 28, 1681, unm.

[3.] (III.) JOHN PARK, of Newton, son of Thomas. The two children by his first wife, probably d. young. Chil. by his 2d wife ELIZABETH:—

3. ELIZABETH, b. Feb. 24, 1695, d. young.

4. JOHN, b. Dec. 20, 1696; m. (1st) ESTHER —; m. (2d) ABIGAIL LAWRENCE, of Newton. He d. May 21, 1747, leaving wife Abigail, one son, Gideon, and one dr., Lois. Chil. (By 1st wife, Esther.)

1. John, b. May 1, 1719, d. young.

(By 2d wife, Abigail.)

2. John, b. May 8, 1723; d. 1741. 3. Samuel, b. Ap. 14, 1725; d. 1741.

4. Gideon, b. Sept. 10, 1729; d. soon. 5. Abigail, b. Ap. 15, 1731; d. young.

6. Lois, b. Aug. 28, 1732; m., 1753, Moses Prince.

7. Gideon, b. Ap. 7, 1734; m., in Newton, Aug. 31, 1758, Hannah Fuller. Chil. [See p. 385, and see Barry, p. 348.]

5. SOLOMON, b. Oct. 16, 1699; m., in Wat., June 21, 1722, LYDIA LAWRENCE. He moved to Holliston, before 1741, where he d. Jan. 2, 1754. Chil. b. in Newton.

1. Keziah, b. Mar. 16, 1723. 2. Lydia, b. May 6, 1725.

3. Mary, b. Aug. 8, 1727. 4. Elizabeth, b. Ap. 27, 1729.

5. Solomon, b. May 21, 1732; grad. Harv. Coll., 1753; d. 1753.

6. Samuel.

6. ELIZABETH, b. Feb. 27, 1701; m., 1720, JOSEPH MORSR. [36.]

7. ABIGAIL, b. Ap. 20, 1702; m., 1724, NATHANIEL WHITTEMORE. [†10.]

8. JOSEPH, b. Mar. 12, 1705; grad. Harv. Coll., 1724; d. 1777. He m., 1732, ABIGAIL GREENE, and had Jonathan, b. Oct. 30, 1733.

9. MARY, b. Mar. 17, 1708; m., 1727, ISAAC SANGER [15.], her cousin.

p. 385. [4.] For Abigail Fiske, read John Fiske.

[5.] EDWARD PARK (son of Thomas), d. in Newton, Mar. 1, 1745, aged 84. Chil. by wife MARTHA (Fiske).

1. MARTHA, b. May 16, 1699.

2. EDWARD, b. Ap. 18, 1701; m. (1st), 1730, EUNICE BARNES. He m. (2d) ELIZABETH —. Chil.,

1. Elizabeth, b. May 1, 1731; m., May, 1758, Dr. John Staples Craft, b. in Newton, Jan. 9, 1733, son of Moses and Esther (Woodward [34]) Craft,

first of Newton, afterwards of Bridgewater, where his son, Dr. J. S. C., settled. [See Jackson, pp. 262-3, and see Mitchell, p. 143.] With his sons, Samael, Moses, Edward, and Zibeon, he went to Maine. Chil.,

1. Thomas, grad. Harv. Coll., 1783, ordained in Princeton, 1786, where he m., 1786, Polly, dr. of Rev. John Porter. [See Mitchell.]
2. Samuel m. — Parkard.
3. John, m., 1790, Olive, dr. of Rev. John Porter, and had,
 1. Jonathan Porter, grad. Brown, Univ., 1817; d. 1822.
4. Moses, m., 1799, Phebe, dr. of Eleazer Snow.
5. Edward. 6. Zibeon, m., 1799, Hannah Howard.
7. Patty, m., 1785, Rev. Zechariah Howard; grad. Harv. Coll., 1784; minister, of Canton.
8. Polly, m., 1798, Rev. Naphtali Show; grad. Dart. Coll., 1790; minister, of Bradford, Vt.
2. *Elisha*, b. Nov. 22, 1733; a physician, of Wellfleet; d. 1770.
3. *Mary*, b. Jan. 17, 1738; m., Nov., 1762, Dr. *Edward Durant*, of Newton. [See Jackson, p. 269.]
4. *Edward*, bap. by Rev. S. Storer, July 8, 1744. (By 2d wife, Elizabeth.)
5. *Martha*, b. June 14, 1749.
3. THOMAS, b. 1703; a weaver, and a selectman of Newton; m., 1748, ELIZABETH HARRINGTON. [? 87.] He d. 1775, aged 72; she d. 1767. Chil.,
 1. *Elizabeth*, b. Jan. 18, 1749. 2. *Jonathan*, b. Nov. 6, 1750.
 3. *Sarah*, b. June 4, 1752. 4. *Thomas*, b. Mar. 8, 1754.
 5. *Ann*, b. Feb. 5, 1756. 6. *Joshua*, b. Aug. 17, 1757.
 7. *Susanna*, b. Oct. 10, 1760.
4. NATHAN, went to Uxbridge.

[9.] (III.) ANNA, the 1st wife of JONATHAN PARK, d. 1691. He m. (2d), ELIZABETH —. He m. (3d), in Wat. Ap. 27, 1715, HANNAH KEMBALL [7.] His Will, dated Jan. 12 (d. Jan. 23), 1718-19, mentions wife Hannah and 6 children. Wife and son Jonathan, ex'rs.

1. JONATHAN, b. Mar. 30, 1695; m. (1st), in Wat., Ap. 28, 1720, SARAH COOLIDGE [108]; m. (2d), about 1721, ABIGAIL —. Chil.,
 1. *Oliver*, b. Feb. 5, 1721, d. 1721. (By 2d wife, Abigail.)
 2. *Jonathan*, b. Aug. 1, 1722. 3. *Sarah*, b. May 8, 1724.
 4. *Abigail*, b. Oct. 30, 1725. 5. *Lucy*, b. Mar. 27, 1727, d. 1730.
 6. *Phineas*, b. June 8, 1729.
2. JONAS, b. Jan. 1, 1697, d. soon. 3. LYDIA. 4. MINDWELL.
5. MARGERY. 6. EUNICE. (By 3d wife, Hannah.)
7. HANNAH, b. Oct. 25, 1718.

[II.] (III.) RICHARD PARK (son of Thomas) "took the house his father last dwelt in, with the barn and orchard, and all the land adjoining within the fence, which includes the new as well as the old field, with the land east, where the old gate stood." He moved to Concord about 1700 (probably to that part which became a part of Lincoln in 1754), and about that time m. (2d), ELIZABETH BILLINGS. Chil. by 1st wife, b. in Newton.

1. WILLIAM, d. s. p. 2. THOMAS, b. Feb. 7, 1690, d. 1703.
3. ABIGAIL, b. July 25, 1693, in 1727 wife of STEPHEN FISKE.
4. RICHARD, b. Mar. 1, 1696; an ensign, of Newton; m., in Newton, July 17, 1717, SARAH FULLER [114, p. 769]. She d. Mar. 20, 1737, aged 42, and he m. (2d), in 1738, ESTHER FULLER [? wid. of Edward Fuller, 94, p. 769]. He d. Nov. 28, 1746, aged 52 [gravestone]. Chil.,
 1. *William*, b. Feb. 16, 1718; m., in Newton, 1745, *Lucy Fuller*, and there had 5 chil., then moved to Lincoln, and by 2d wife, *Lydia*, had 5 others.
 1. *Penuel*, b. May 12, 1746 [see 81, p. 388].
 2. *Richard*, b. Feb. 28, 1748.
 3. *Esther*, b. Dec. 25, 1749; m., in Wat., Feb. 14, 1773, John (?) *Savage*.
 4. *William*, b. Aug. 25, 1761.
 5. *Cornelius*, m. in Wat., Oct. 19, 1777, *Abigail Sangir*.

(By 2d wife, Lydia, b. in Lincoln.)

6. Lucy, b. July 24, 1757; m., Ap. 9, 1793, Jonathan Whitney, of Wat.
 7. Elizabeth, b. May 5, 1758. 8. Mehitabel, b. Aug. 17, 1760.
 9. Jacob, bap. Feb. 27, 1763. 10. Lydia, b. June 18, 1765.
 2. Thomas, b. Nov. 15, 1719.
 3. Jerusha, b. Nov. 22, 1722; m., in 1740, James Troubridge, Jr. [20], and settled in Worcester.
 4. Hilda, b. Dec. 18, 1724. 5. Priscilla, b. Ap. 5, 1726.
 6. Abigail, b. June 28, 1728.
 5. SARAH, b. May 11, 1699, d. 1699.

(By 2d wife, Elizabeth.)

6. JOSEPH, of Concord; [m. very early, or was a son of the 1st wife. See p. 386 [12 to 21]].

- p. 386. [24.] It was Josiah Park, Sen., who m. Mary Merriam.
 [27.] Josiah Parke, Jr., pub. May 12, 1750, with Sarah Munroe, of Weston [Munroe, 20, p. 371]. They probably did not marry, as she m., Dec. 27, 1753, Elisha Cutler, of Lex., and he (J. P., Jr.) living at the date of his father's Will, Dec. 18, 1764, d. Nov. 1765.
 [32.] Jonathan. He was probably the Jonathan Parks slain by Indians about 1725. [See Geneal. Reg. vii., p. 64.]

- p. 388. **PARKER.**—The name of the wife of William Parker, the early proprietor of Wat., was, in 1641, Elizabeth. He was witness in Court in a Watertown case in Ap. 1650, and it there appeared that he had lived on Long Island. He was a proprietor of Sudbury in 1639–40. Patty Parker, dr. of William Parker, bap. in Boston, 11th 12mo., 1648.

Stephen Parker, of Wat., was probably a son of Joseph Parker, of Newbury, afterwards of Andover, where his son Stephen was born in 1651. [See Coffin, p. 313, and see Farmer]. Ap. 3, 1712, John Underwood, of Wat., sold to Stephen Parker, of Charlestown, 30 A., bounded E. by Ebenezer Wellington; W. by John Barnard; N. by J. B. and Nathaniel Bright; S. by highway. Also, 30 A. of Woodland, bounded E. by Henry Spring; W. by highway; N. by Samuel Randall and John Hammond; S. by Thomas Straight. Also, 8 A. of meadow, bounded E. by Richard Coolidge; W. by P. Shattuck; N. by Beaver Brook; S. by John Dix. He probably moved from Charlestown to Wat. about the date of this purchase. Hepzibah Parker, who m. Jonathan Phillips [72], was a dr. of Stephen.

- p. 391. **PARKHURST.**—[47–1.] John Luke Parkhurst, grad. Brown Univ. 1812, studied Theology at And. Theol. Sem., and was licensed by the Mendon Association. He never took a pastoral charge, but devoted his life to teaching. [See a Memoir of his life, in the History of the Mendon Association, pp. 293–6.] He m. (1st), Aug. 30, 1819, Persis Goodale, dr. of Dea. Abner and Mary Goodale, of Marlboro. She d. in Wiscasset, Me., Jan. 25, 1829; aged 34. He m. (2d), Maria C., dr. of James and Sarah Harriman, of Wiscasset. He d. in Gorham, Me., May 30, 1850, aged 61, leaving wid. Maria C., now of Gardner, Me. Chil.,

1. William Goodale, a Phonographic Reporter, at Washington, D. C.
 2. Henry Martyn, Phonographic Reporter for U. S. Senate.
 3. Edward Warren, a fancy painter, Gardner, Me.

(By 2d wife.)

4. John Thurston, a farmer, of Gorham.
 5. Sarah Elizabeth, assistant of her brother, Henry M.
 6. Charles Stewart. 7. Leonard Woods. 8. Alpheus Crosby. 9. Melville Cox.

PARRIS.—Was Samuel Parris, of Wat., the first minister of Danvers, settled there about Nov., 1689? [See Mass. Hist. Coll., 3d Ser. III., p. 169.] Samuel Parris was a schoolmaster in Wat., in June, 1700. It is very doubtful whether he ever lived in Watertown Farms.

- [2.] Dorothy (dr. of Rev. S. Parris), b. in Newton, Aug. 28, 1700.
 [3.] Noyes (son, do.), b. in Newton, Aug. 22, 1699.
 [4.] Samuel, bap. by Mr. Angier, Mar. 1, 1701–2.

PARSONS.—Concerning the sad story of Hugh Parsons and his wife, Mary, see Drake's History of Boston, pp. 322-4. At a town meeting, Dec. 10, 1649, a small grant was made to Hugh Parsons. Oct. 22, 1653, money was granted "to make a house" for him. Jan. 31, 1659-60, the selectmen ordered some corn to be supplied to Hugh Parsons, for his family. Among the expenses Dec. 29, 1663, are corn and silver furnished to H. Passam (Parsons), when his wife was sick, and H. Godden's, bill for dressing his leg. He had lands, but needed aid on account of his infirmities. [See Blois p. 685].

PATTEN.—THOMAS PATTEN was selectman of Wat., 1786, 87, 89, 90, 91. Chil.,

1. *John*, reckless, went off and never heard of.
2. *Mary* m. — *Stuart*, of Alexandria, D. C.
3. *Thomas*, m., and settled in Alexandria, D. C.
4. *Isaac*, of Wat., on the homestead.
5. *William*, settled in Roxbury. 6. *Samuel*, d. aged 10 years.
7. *Charles*, d. many years ago.

p. 392. **PATTERSON.**—James Patterson ["Pattison"], from Scotland, embarked at London, Nov. 6, 1651, in the *Sarah* and *John*; of *BillERICA*; was adm. freeman, Ap. 18, 1690.

p. 393. **PEIRCE.**—[1.] For adm. freeman, Mar., 1637-8, read, took oath of fidelity, 1652. [?] William Peirce, of Wat., took oath of fidelity, in 1652.

1 [1.] ROBERT PEIRCE, son of John and Elizabeth, of Wat., m. MARY —, and settled in Woburn. She d. Mar. 18, 1701, and he, "old Robert Peirce," d. in Woburn, Sept. 10, 1706. Chil.,

2 1. *Judith*, b. Sept. 30, 1651; d. in childbed, May 30, 1689, leaving daughter *Miriam*, b. May 17, 1689.

3 2. *Mary*, b. Jan. 21, 1652-3; m., Oct. 14, 1671, *John Walker*.

4 3. *Nathaniel*, b. Dec. 4, 1655; m. (1st), Dec. 27, 1671, *Hannah Converse*, (?) b. July 15, 1644, dr. of James Converse. She d. Mar. 23, 1679 or 80, and he m. (2d), Mar. 22, 1680-1, *Elizabeth Foster*. He d. 1692. Chil.,

5 1. *Nathaniel*, b. Feb. 2, 1678-9; m., June 2, 1701, *Lydia Francis*, of *Medford*.

(By 2d wife, Elizabeth.)

6 2. *Mary*, b. July 31, 1682.

3. *Hannah*, b. Ap. 24, 1684; d. Nov. 14, 1688.

7 4. *Ichabod*, b. June 23, 1686; m., Dec. 24, 1706, *Sarah Walters*.

8 5. Robert (probably the eldest child), d. May 14, 1689.

9 4. *Jonathan*, b. Feb. 2, 1662; d. June 17, 1694; m., Nov. 19, 1689, *Hannah Wilson*.

1. *Hannah*, b. Mar. 8, 1691; d. Sept. 13, 1693.

2. *Jonathan*, d. July 7, 1694.

10 5. Had he a son Benjamin?

11 *Judith Peirce*, dr. of John and Elizabeth, of Wat., m., in Woburn, Jan. 30, 1644-5, *Francis Wyman*. She d. previous to 1650, leaving dr. *Judith*, who d. Dec. 22, 1652. Having d. before the date of the Will of her mother, *Elizabeth Peirce*, and without heirs, she is not mentioned in said Will.

12 JOHN PEIRCE, of Woburn, supposed to be a son of John and Elizabeth, of Wat., had, 1. *John*, b. Nov. 23, 1644. 2. *Joseph*, b. Sept. 12, 1646. 3. *Thomas*, b. May 3, 1649; (?) m., Mar. 24, 1680-1, *Rachel Bacon*.

[12.] Early in 1648, Daniel Peirce brought suit in Salem, against the town of *Water-town*, and Lieut. Hugh Mason was sent there to answer for the town.

[2.] Mar. 14, 1682-3, admin. on estate of Anne, wid. of Anthony Pierce, granted to (sons) Joseph and Benjamin Peirce, and Lieut. Richard (not Wm.) Way, att'y in behalf of wid. and chil. of John Peirce, deceased.

[3.] John Peirce, eldest son of Anthony, by his Will, dated Oct. 21, proved Nov. 7, 1682, gave all his estate, inherited from his father or grandfather, to his wife Ruth, "for to bring up my children." [Suff. Prob. vi., p. 389.]

[4.] This Ralph Read, was brother of George, who m. Elizabeth Jennison [3].

- [6.] Was this the Martha, who m., in 1669, Thomas Noyes, of Sudbury? [See Farmer.] p. 394. [21.] Benjamin Peirce was a deacon.
 [25.] Samuel Peirce, was selectman, 1731, 32, 34, 35, 36, 37.
 [25-6.] Josiah Convers, son of James Thomas, of Boston, bap. in Wat., Ap. 8, 1764.
 p. 395. [28.] Joseph Peirce, a weaver, of Wat., was selectman, 1708, 13, 22, 36, and 37.
 [31-1.] (?) Anthony Pierce and wife Keterah, adm. to Mr. Angier's church, in E. Bridgewater, 1741. [See Mitchell, p. 272.]
 [40.] Hannah was the 3d wife of J. Locke. [See Locke Family, p. 18.]

- [43.] 1 (V.) JOHN PIERCE, b. Sept. 1, 1730; a weaver, of Wat.; m. REBECCA— Mar. 4, 1731, he purchased of Preserved Tucker (for £75), 27 acres of land in Stoughton, whither he moved after the birth of his 2d child. This land is within the present limits of Canton, and it passed to his son Seth, and then to his grandson Jesse. This branch of the family write their name, Pierce. [See Peirce 43, p. 395.]
- 2 1. ELIPHALET, b. in Wat., July 29, 1728; m., in Stoughton, July 9, 1757, PATIENCE COPP.
- 3 2. SETH, b. in Wat., Nov. 5, 1730; m., Aug. 19, 1756, ANGELETT CLARK, of Stoughton, where he settled. Chil.,
- 4 1. Nathaniel, b. Sept. 28, 1757; of Holliston.
- 5 2. Jesse, b. Aug. 25, 1761; d. Mar. 5, 1832; m. Patience —, who d. Nov. 23, 1810, aged 43 yrs. Chil.,
- 6 1. Jesse, b. Nov. 7, 1788; a Colonel, and several years Rep. of Canton; m., Sept. 9, 1824, Elizabeth Smith Lillie, a dr. of Major John Lillie, who was an Aid of Gen. Knox, in the Revolution. Chil.,
- 7 1. Henry Lillie, b. Aug. 23, 1825.
- 8 2. George, b. June 20, d. Sept. 28, 1827.
3. Edward Lillie, b. May 29, 1829; grad. Brown Univ., 1850; LL.B., Harv. Coll., 1852.
- 9 2. Otis, b. Ap. 17, 1790. 3. John, b. Ap. 21, 1792.
- 11 4. Joel, b. Dec. 23, 1793. 5. Nathan, b. Feb. 22, 1796.
- 13 6. Mason, b. May 26, 1798. 7. Anna, b. and d. Feb., 1800.
- 14 8. Anna, b. Jan. 11, 1801. 9. Catherine, b. Feb. 8, 1803; d. May 30, 1842.
- 15 10. William, b. Feb. 6, 1805. 11. Rebecca, b. May 4, 1807.
12. Relief, b. May 11, 1809, d. young.
- 17 3. Seth, b. Feb. 12, 1764; d. July, 1825; m., 1786, Alice Gay, b. Aug., 1771; d. Mar. 29, 1815. Chil.,
- 18 1. Thacher, b. Aug., 1787; d. in Easton, Mass., 1838; m. Polly Stone, and had, 1. Polly. 2. Thacher. 3. Mira.
- 19 2. Willard, b. Mar. 15, 1790; grad. Brown Univ., 1818, now (1853), a minister, of Abington, Mass. He m. Eleanor W. Everett, of Foxboro, b. Mar. 26, 1805. Chil.,
- 20 1. Eleanor, b. Nov. 26, 1825; d. Nov. 5, 1827.
2. Ellen W., b. Oct. 16, 1827; m. John A. King, of Abington. Chil.,
1. Alice. 2. Henrietta.
3. Ann, b. Aug. 20, 1829; d. Mar. 12, 1832.
- 21 4. Alexander Everett, b. July 27, 1831.
- 22 5. Harriet Anna, b. Aug. 16, 1833.
- 23 6. Edward Willard, b. Dec. 1, 1835.
- 24 7. Gardner Charlotte, b. Feb. 22, 1838.
- 25 8. John Metcalf, b. Aug. 22, 1842.
- 26 3. Clarissa, b. Sept. 23, 1793; m. Salmon Turner. Chil.,
1. Elbridge G. 2. Willard P. 3. Salmon. 4. Calvin K. 5. Clarissa.
- 26½ 4. Harriet, b. July, 1796; m., Feb., 1820, Levi Hawes. She d., leaving 3 chil., 1. Harriet. 2. Simeon. 3. Jason.
- 27 5. Priscilla, b. Sept., 1798; d. Ap. 2, 1831; m. (1st), James Pickins. 3 chil. 1. Ezra. 2. James. 3. Priscilla. She m. (2d) Thomas Shepherd, now (1853) of Easton. Chil., 4. Thomas. 5. John. 6. Rebecca.
- 28 6. Roxa, b. July, 1802; m. (1st) Abram Shaw, of Middleboro, and had, 1. Hannah. 2. Abram. She m. (2d) Jacob Cushman, and had,

3. Hannah Pierce. 4. Sarah Morton. 5. George. 6. Sarah Elizabeth. 7. William Jacob. 8. Florella Gertrude.
- 29 7. Harris, b. May, 1807; d. Nov. 26, 1826.
- 30 8. Seth, b. Aug., 1812; d. July, 1815.
- 31 4. *Angelett*, b. June 16, 1769; m. *Seth Crane*, of Stoughton. Chil.,
- 32 1. Angelett, m. — Kingsbury, of Needham.
- 33 2. Polly, m. George Jackson, of Boston.
- 34 3. Rebecca, m. — Bingham, of Dedham.
- 35 4. Luther, (?) went to New Orleans.
- 36 5. Jephtha, has descendants in Canton.
- 37 6. Silas, d. unm.
- 37 3. ELIZABETH, b. in Stoughton, Ap. 13, 1734.
- 38 4. ABIGAIL, b. in S., Ap. 30, 1740.
- [†47.] Elizabeth, m. Timothy Fessenden, b. May 6, 1731, son of Thomas and Abigail (Locke) Fessenden, and settled in Westminster, where she d. Jan. 18, 1808, aged 72. 13 chil. [See Locke Family, p. 45.]
- p. 396. [50.] Suit in C. C. P. Mid. 1732, Stephen Peirce, of Windham, Conn., vs. Ebenezer Ward, to whom he bound his son Stephen, at Wat., May 20, 1730. Jan. 13, 1733-4, Stephen Peirce and wife Abigail, dismissed from Waltham Church, to Windham Village, alias Canada.
- p. 397. [82.] Isaac Peirce, m., Mar. 20, 1786, Anna Sanderson. [76.]
- [92.] For 92, in the margin, read 46. 92. The Will of Samuel Peirce, of Waltham, was dated Mar. 26, 1772.
- p. 400. [158.] Daniel Pierce, wife and family, moved from Wat. to Camb., in Ap., 1761. [161.] For Abigail Garfield, read Deborah Garfield.
- p. 401. [228.] [See 17, p. 540].

p. 402. **PENDLETON.**—Mr. Bryan Pendleton was the first of the petitioners for a grant of Sudbury. In May, 1640, he was desired by the Court, "to train the company at Sudbury." After this, he returned and resided some years in Watertown. In 1661, the selectmen of Portsmouth granted Capt. Pendleton, liberty "to up his windmill upon the Fort-point, towards the beach, because the mill is of such use to the public." Major Pendleton "possessed a large estate," probably much larger than any other in Portsmouth. [See Annals of Portsmouth, p. 63.] His Will, dated Portsmouth, Aug. 9, 1677, proved Ap. 5, 1681, mentions wife Eleanor, son James; grandchild, James Pendleton, Jr., and grandchild, Pendleton Fletcher; granddaughters, Mary and Hannah Pendleton, "which my son had by his former wife;" gr. son Brian Pendleton. Besides house, household goods, and land in Portsmouth, he possessed housing and land at Cape Porpus; 640 acres east side of Westbrook, near Saco Falls; 100 A. upland, and 10 A. meadow, bought of John Bush, in the township of Cape Porpus, adjoining Prince's Rock; "my several islands in or near Cape Porpus; my farm at Winter Harbor;" three plantations or lots in Wells, and "land on the great island Piscataqua." [See Geneal. Reg. III., p. 122.] James Pendleton, m. (2d) in Sud., Ap. 29, 1656, Hannah Goodnow, b. Nov. 28, 1639, dr. of Edmund and Hannah. James Pendleton was one of the nine persons, who, in 1671, entered into covenant, and composed the First Church of Portsmouth, of which Rev. Joshua Moody, was the first pastor. He moved to Stonington, Conn., before 1681. Chil. by 2d wife Hannah. 1. Bryan, b. Sept. 27, 1659. 2. Joseph, b. Dec., 1661. 3. Edmund, b. June 24, 166-. 4. Ann, b. 1667. 5. Caleb, b. Aug. 8, 1669. It is very probable that Bryan was the 2d child by this wife. [See Farmer.]

PERKINS.—Caution against (settlement of) wid. Mary Perkins, who came from Boston to Wat., Jan. 12, 1738. Caution against (settlement of) wid. Jean Perkins and her dr. Susanna, a minor, who came from Boston to Wat., in Oct., 1746. [See Bridge 41, p. 95.]

PERRY.—[1.] William Pary, adm. freeman, May 6, 1646, was probably the William Perry, of Wat., where the name, in the records, is frequently written Parry. In a deed executed by William Perry, Ap. 8, 1673, the name of his wife in the instrument is written Joanna, but it is signed Annah. Sept. 30, 1672, Capt. Hugh Mason made a motion in Court, that William Perry, aged 66, be excused from training. There was

a William Perry, of Medfield, in 1674, who m. Susan, sister of Michael Barstow, of Watertown.

Inventory of the goods of Joanna Perry, of London, personal, in the hands of Nathaniel Holland, of Wat., prized Mar. 19, 1667-8, by William Bond and Joseph Tainter. Aug. 6, 1667, John Perry, principal, and John Clary, surety, gave bonds concerning the estate of Joanna Perry;—Josiah, brother of John, being beyond the sea. Perhaps this Joanna was the wid. of John, of Rox., who was adm. freeman, Mar. 4, 1632-3, and d. Sept. 27, 1642. He had a son John, b. 1639, and this son may have been John, [4.] of Wat., who had two sons named Josiah.

[Samuel Perry, of Rox. (? son of Wm. [1.]), by wife Sarah, had, 1. Nathaniel, b. Aug. 27, 1685 (? 84). 2. Nathaniel, b. Jan. 3, 1685-6. 3. Joseph, b. Dec. 20, 1688.]

[3.] Obadiah Perry, is said, by Farmer, to have been one of the founders of the Church in Dunstable. Was Ebenezer Perry, of Newton, 1731, and of Camb., in 1734, a son of Obadiah?

[4.] Dec. 4, 1688, John Perry, of Wat., tailor, in Aug. last, "did utter and give forth words tending to move discord, strife, and dissension among his neighbors, and on 25th August, did break the common pound of the town." Prosecuted by — Garfield, gave bond £10, and was discharged the next March.

[5.] Feb. 19, 1701-2, John Perry, of Wat., bought of Mary Cook (ex'x of Philip, of Camb.), and Samuel and Philip Cook, 6 A. in Camb. (Lex.), whither he afterwards moved.

p. 403. [27.] Josiah Perry was Constable of Wat., 1729 and 31, and appointed Sealer of weights and measures, Mar. 14, 1737-8.

[36.] John Clary, late of Hadley, by Will, without date, proved Mar. 31, 1691, mentions son-in-law John Perry, and Sarah his wife, and his grandchild John Perry [5.], and his brother Joseph [36.]. John, the grandchild, d. in the lifetime of Sarah, his mother, who d. Oct. 11, 1730. In 1731, Joseph Perry, of Brookfield, weaver, brought suit for land in Wat., against John Perry [6.], of Lex., and Ebenezer Perry [20.], of Newton, cordwainer.

PHILBRICK.—Philbrick, succeeds Phillips.

PHILLIPS.—Henry Phillips went from Wat. to Dedham about 1636, as a candidate for the office of teacher in the Church. He m. ^{MARY} Anne, a daughter of John Dwight, who also went from Wat. to Dedham. He returned to England in 1642 [Winthrop, II., p. 389]. What affinity there was, if any, between Rev. George Phillips, this Henry Phillips, and Hannah Phillips "of Watertown," who m., Sept. 1, 1638, Joseph Morse, first of Dedham, afterwards of Medfield, has not been ascertained. Henry Phillips was ensign, of Dedham, in 1648 [Colon. Rec. II., p. 258]. Hannah, wid. of Joseph Morse, m., in 1658, Thomas Boyden, an early settler of Watertown, then said to be of Medfield. In her Will, dated 1676, she mentions her daughters Elizabeth and Sarah Lawrence [see 23, p. 821, and 32, p. 822].

Rev. GEORGE PHILLIPS, the first minister of Watertown, was a son of Christopher Phillips, "mediocris fortunæ," of Rainham, St. Martin, Co. Norfolk. He entered Gonville and Caius Coll., Camb., Ap. 20, 1610, then aged 17 years; grad. B. A. 1613, and M. A. 1617. He gave early indications of deep piety, uncommon talents, and love of learning, and at the University distinguished himself by his remarkable progress in learning, especially in theological studies, for which he manifested an early partiality. He was settled in the ministry at Boxford,* Co. Suffolk; but his strong attachment to the principles of the old nonconformists brought him into difficulty with some of his hearers, and as the storm of persecution grew more dark and threatening, he resolved to take his lot with the Puritans, who were about to depart for the new world. On the 12th of April, 1630, he, with his wife and two children, embarked for America in the Arbella, as fellow-passenger with Governor Winthrop, Sir Richard Saltonstall, and other assistants of the Massachusetts Company, and arrived at Salem June 12, where his wife died very soon, and was buried by the side of Lady Arbella Johnson. Mr. Phillips was adm. freeman May 18, 1631, the earliest date of any such admission. He continued to be the minister of Watertown Church 14 years, greatly respected and beloved, and he died the 1st, and was buried the 2d of July, 1644, aged about 51 years. Winthrop [II., p. 171], says, he was "a godly man, especially gifted, and very peaceful in his place, much lamented of his own people and others."

* (?) Boxted, Co. Essex.

Mr. Phillips was distinguished for his learning in the original languages of the Scriptures, and in theological doctrines. Mather says his hearers counted him "the irrefragable Doctor;" and Johnson says he was "mighty in the Scriptures, and very diligent to search out the mind of Christ therein contained." He was independent and conscientious in forming and maintaining his opinions. He had repeated theological controversies, in which he was characterized by candor and Christian urbanity. It is evident, from the brief records of his life, that he brought with him less of the ecclesiastical leaven of the old world than the rest of his brethren, and that he and his people, especially Sir Richard Saltonstall and Mr. Richard Browne, entertained more enlightened views of civil and religious liberty, or had a more just appreciation of it, than then belonged to other planters of Massachusetts Bay. He was the earliest advocate of the Congregational order and discipline, in which he was, says Hubbard, deeply versed, and very skilful. His views were, for a time, regarded as novel, suspicious, and extreme; and he, with his ruling elder, Mr. Richard Browne, stood almost unaided and alone, until the arrival of Mr. John Cotton, in firmly maintaining what was, and still is, the Congregationalism of New England.

Mr. Phillips and Mr. Richard Browne are entitled to another honor, much more distinguished than has generally been conceded to them. When the Governor and Assistants passed an order to tax the people, without their consent, they called together the people of Watertown, and "delivered their opinions," that it was dangerous to submit to it. For this they were arraigned before the Governor, and there was "much debate" on the subject. The result seems to discredit the statement of Winthrop, that "they confessed they were in error;" for very soon afterwards, before another attempt was made to levy a tax, the Court ordered (May 9, 1632), that "two of every plantation be appointed to confer with the Court, about raising of a public stock," and this soon led to the institution of a representative body in the government of the Colony. It is not now easy to estimate the extent and importance of the influence of Mr. Phillips in giving form and character to the civil and ecclesiastical institutions of New England [See Winthrop's Journal, in many places during Mr. Phillips's time; Hubbard's History, p. 186; Mather's Magnalia, Book III., Part II., Chap. 4; also, Richard Browne, p. 117, and John Oldham, p. 863; Francis' History, pp. 13-38.]

His nuncupative Will was witnessed July 5th, and proved Sept. 6, 1644, by Dr. Simon Eire and Apphia Freeman. [See General Reg. III., p. 78]. His Inventory, taken July 22, 1644, by the four Deacons, Ephraim Child, Thomas Hastings, Nicholas Guy, and Simon Stone, amounted to £553 2s. 9d. One item was "the study of bookes £71 9s. 9d."

Greg Phillips

The locality of Mr. Phillips's first residence in Watertown has not been clearly ascertained. It is conjectured that he first settled on the Cambridge road, near the Camb. line, by the side of Sir R. Saltonstall, and within the present limits of Cambridge, and that he not long afterwards moved to the vicinity of the old graveyard. "There is a tradition," says Dr. Francis, "that he lived in the house now (1830), occupied by Mr. Daniel Sawin, opposite the old burying-ground." The homestead of Samuel Saltonstall (bounded S. E. by Charles River, and separated from the then boundary-line of Cambridge only by the intervening 13 A. homestead of Thomas Brigham) was bounded N. W. by land of George Phillips. Samuel was the only son of Sir R. Saltonstall, who settled permanently in Watertown, and it is probable that his homestead was the one selected by his father. In the list of possessions in Watertown, made out in compliance of an order passed in 1642, for the purpose of assessments, the lands of Mr. Phillips are not included, probably because they were exempt from taxation. The records show that he had liberal grants of land.

The first wife of Mr. Phillips, as already stated, died at Salem very soon after landing. She was a daughter of Richard Sergeant, and probably a half-sister of John Hayward, an early settler of Watertown. They were probably children of the same mother, but of different fathers. Cotton Mather says she was "an only child," that is, as we suppose, of her father. The grounds for this opinion are the following:

Nov. 12, 1644 (about 4 months after the d. of Mr. Phillips), "The General Court declared that they think it just and meet that Mrs. Phillips make over so much estate as shall secure £100 to Samuel and Elizabeth Phillips, grandchildren of Richard Sergeant, or otherwise give bond with sureties [to] the consent and satisfaction of Capt. Cooke, Mr. Sparhawk, and John Bridge, who are intrusted in the business by the Court; this security to be given in a month." In the margin of the original record, they are called Mrs. Phillips's "son and daughter-in-law." The next year (1645), Dea. Ephraim

Child and John Hayward (the supposed uncle of Samuel and Elizabeth Phillips), petitioned the Court that Samuel Phillips, son of Rev. George Phillips, deceased, may have maintenance assigned him out of his father's estate. This was asked for at this time in behalf of Samuel, because he was commencing a collegiate education, and not for his sister Elizabeth, because then probably not more than 16 or 18 years of age. In the grants of the Beaver Brook plowlands, ordered in Sept. 1636, 40 acres were assigned to Mr. Phillips, bounded E. by land of Edward How; S. by footway through the plain to Beaver Brook; N. by highway to Sudbury; W. by land of Edward Garfield. Ap. 11, 1649, Samuel Phillips, student of Harvard College, for £16 10s., sold to Edward Garfield the western half of his lot. May 17, 1651, Elizabeth Phillips, widow and sole executrix of George Phillips, deceased, debtor to Job Bishop, of Ipswich, New England, for a certain sum or sums of money due to *Elizabeth Bishop, wife of said Job Bishop, and daughter of said George Phillips, deceased*, conveyed to Job Bishop and wife Elizabeth the eastern half of said 40 A. lot of Beaver Brook plowland, which land Bishop and wife soon afterwards sold to Edward Garfield.

John Hayward, by his Will, dated July 31, 1672, then aged 79 [Mid. Prob. Rec. iii., p. 275], divided his estate between his wife Mary and Samuel Phillips, of Rowley, whom he appointed joint executors. [It is supposed that Elizabeth (Phillips) Bishop died before 1657, s. p., and therefore is not referred to in this Will.]

Rev. Samuel Phillips, of Rowley, in his Will, mentions property bequeathed to him by "my uncle Hayward."

Widow Mary Hayward, by her Will [Suff. Prob. vi., p. 456], bequeaths her estate to persons who had only small legacies from her husband, John Hayward, and who were her children by another husband; but she does not mention any of the Phillips family, which renders it very improbable that there was any consanguinity between her and that family.* [See Hayward, p. 793.]

Mr. Phillips m. (2d), ELIZABETH —. Nothing has been ascertained respecting her parentage or family, but it is probable that she was the widow of Capt. Robert Welden. [See Welden, p. 626; also, Drake's Hist. of Boston, p. 118.] She d. in Wat. June 27, 1681. By her Will, dated Oct. 20, 1674, wit. by Samuel Stearns and Nathaniel Holland, she gives to "son Samuel all Latin, Greek, and Hebrew books now in the house;" to Job Bishop, 1 shilling [his wife, her step-dr, being d.]; to James Barnard, "who married my daughter Abial" (Abigail), 1 shilling [she had d. 1672, s. p.]; to sons Zerobabel, Jonathan, and Theophilus, the "rest of my estate."

Sept. 30, 1681, Samuel Phillips, of Rowley (his mother-in-law being deceased) granted a power of att'y to William Bond and Jonathan Pickard to act for him. Oct. 4, 1681, admin. on estate of George Phillips was granted to Samuel Phillips, of Rowley, and Jonathan Phillips, of Watertown. Dec. 20, 1681, William Bond, Joseph Tainter, and Simon Stone, Sen., were appointed by the Court to divide Mr. Phillips's estate. They reported Ap. 3, 1682, and the next day, Ap. 4, Capt. John Sherman, William Bond, and Simon Stone, were appointed to divide the estate of "Mistress Phillips" among her children. They reported that nothing could be done.

Chil. of Rev. GEORGE PHILLIPS.

8. 2 1. SAMUEL, b. at Boxstead, Co. Suffolk, England, 1625; grad. Harv. Coll. 1650. It has been said that the expense of his education was assumed by the town, as a token of respect for his father. This, however, may be questioned; for, in the first place, his father left a comparatively good estate for that period; and in the next place, in 1645, before he entered college, his uncle, John Hayward, and Dea. Ephraim Child, petitioned the Court that he might have a maintenance assigned him out of his father's estate.
- 3 2. ELIZABETH, b. in England; m., previous to May 17, 1651, Job Bishop, of Ipswich. As she is not mentioned, nor any heirs of her, in the Will of John Hayward; as wid. Elizabeth Phillips, in her Will, mentions Job Bishop, but not his wife, and as Job Bishop had no children born (no birth recorded), before June 1657, it is presumed that his wife, Elizabeth (Phillips) d. early, s. p., and that he had a 2d wife, who was the mother of his children. [Thomas Bishop, merchant, of Ipswich, as early as 1636, d. Feb. 7, 1671, leaving wid. Margaret;

* June 7, 1705, Sarah Phillips, of Rowley, widow, sold to Benjamin Brown 3½ acres, being one-half of 7 acres granted to John Hayward (Howard), being the 64th lot in the division of remote meadow [in Wat. Farms.] On Sept. 5, 1704, Samuel Aldridge, tailor, Hannah Aldridge, widow, Thomas Aldridge, John Woodcock, and Sarah, his wife, Eleazer Kingsbury, and Esther, his wife, sold to Benjamin Brown the other half of the said 7 acre lot. [See Hayward, in Part II., p. 793.]

- sons Samuel, John, Thomas, Job, and Nathaniel, and brother Paul Bishop, of Kingston. He was Deputy to the Gen. Court in 1666, and was comparatively very rich for that period, his estate being appraised at £5000 1s. 1d.]
(By 2d wife, Elizabeth.)
- 4 3. ZOROBABEL, b. Ap. 6, 1632; was living at Long Island in Ap. 1682, when Joseph Tainter, of Wat., was his att'y in regard to his right in his parents' estate. He settled at South Hampton as early as 1663, and married Ann White.
13. 5 4. JONATHAN, b. Nov. 16, 1633; a magistrate, of Watertown.
21. 6 5. THEOPHILUS, b. May 28, 1636.
6. ANNABEL, buried Ap. 11, 1638, aged 4 months.
7. EPHRAIM, b. and d. June, 1641. 8. OBADIAH, buried Ap. 5, 164--.
- 7 9. ABIGAIL (Abial), birth not recorded; m., Oct. 8, 1666, JAMES BARNARD [Barnard, 5]; she d. in Sudbury, Sept. 1672, s. p.
-
2. 8 (II.) Rev. SAMUEL PHILLIPS, settled in Rowley, in 1651, as colleague of Rev. Ezekiel Rogers. He "was highly esteemed for his piety and talents, which were of no common order, and he was eminently useful, both at home and abroad. He officiated repeatedly at the great public anniversaries, which put in requisition the abilities of the first men in the New Eng. Colonies. It is not known that any of his productions were printed; yet it is on record that, in 1675, he preached the Artillery Election Sermon, and also the Election Sermon in 1678." [See Gage's History of Rowley.] In Sept. 1687, an information was filed by one Philip Nelson, against Rev. Samuel Phillips, of Rowley, for calling Randolph a wicked man; and for this crime [redounding to his honor] he was committed to prison. [See Washburn's Judicial History of Massachusetts.] He m., in Oct. 1651, SARAH APPLETON, born in England, in 1628, dr. of Samuel and Mary (Everhard) Appleton, of Ipswich. She was a descendant of John Appleton, who d. at Great Waldingfield, Co. Suffolk, Eng., in 1436. [See Geneal. Reg. V., p. 144; vii., p. 37 and 38; Hist. of New Ipswich, pp. 298 and 99.] [Her father usually had the respectful prefix "Mr.," and was often elected a Rep. to the Gen. Court. In 1641, he had permission to set up a malt-house, and he is said to have been a cultivator of hops. He (S. A.), d. in Rowley, June 1670, probably at Mr. Phillips's house.] Mr. Phillips d. Ap. 22, 1696, greatly beloved and lamented. His widow d. July 15, 1714, aged 86. His inventory amounted to £989. In Nov. 1839, a chaste and handsome marble monument was placed over the remains of Mr. Phillips and his wife, in the burial-ground of Rowley, by Hon. Jonathan Phillips [147], of Boston, their gr. gr. grandson. Upon it is an inscription to their memories, and likewise to several of their honorably distinguished descendants.
- Samuel Phillips*
1. SAMUEL, b. Mar. 1654, d. young.
- 9 2. SARAH, b. Feb. 7, 1656; m. STEPHEN MIGHILL, b. 1651, son of Thomas and Ellen Mighill, of Rowley. Chil., 2 drs. and 1 son, viz.:
1. Nathaniel, b. 1684; m. Priscilla Pearson. 10 chil.
1. Stephen, b. 1707. 2. Ezekiel, b. 1710. 3. Nathaniel, b. 1715.
4. Thomas, b. 1722. 5. Jeremiah, b. 1724; and 5 drs.
38. 10 3. SAMUEL, b. Mar. 23, 1657-8; a goldsmith, of Salem.
4. GEORGE, b. Nov. 23, 1659; d. Jan. 18, 1662.
5. ELIZABETH, b. Nov. 16, 1661; bur. June 10, 1662.
6. EZEKIEL, b. Feb., 1662; d. Mar. 1, 1662-3.
44. 11 7. GEORGE, b. June 3, 1664; grad. Harv. Coll., 1686; of Brook Haven, L. I.
- 12 8. ELIZABETH, b. Aug. 2, 1665; m., Nov. 7, 1683, Rev. EDWARD PAYSON, b. June 20, 1657, son of Edward and Mary (Elliot) Payson, of Rox., grad. Harv. Coll., 1677; the fourth minister of Rowley; settled Oct. 25, 1682, as colleague of Mr. Phillips. She d. 1724. He m. (2d), in 1726, ELIZABETH, wid. of Hon. Samuel Appleton, of Ipswich, dr. of William Whittingham, of Boston, and great granddr. of Rev. William Whittingham, pastor of the Cong. Church, at Geneva, Switzerland. [See Hist. of Rowley, p. 21.] He d. Aug. 22, 1732. 20 chil., all by first wife, of whom 3 not named d. in infancy, and 10 survived him, viz,
1. Elizabeth, b. 1684. 2. Sarah, b. 1686.
3. Mary, b. 1687; m. Joseph Jewett, Jr.

4. *Eliphalet*, b. 1689. 5. *Mehitabel*, b. 1691; m. *Humphrey Hobson*.
 6. *Samuel*, b. 1693; grad. Harv. Coll., 1716; d. 1768.
 7. *Edward*, b. 1694. 8. *Elizabeth*, b. 1697; m. *Ezekiel Northend*.
 9. *Hannah*, b. 1698. 10. *Elliot*, b. 1700; m., *Mary Todd*. 5 sons and 2 ds.
 11. *Stephen*, b. 1701. 12. *Sarah*, b. 1702. 13. *Jonathan*, b. 1703.
 14. *David*, b. 1705. 15. *Phillips*, b. and d. 1707. 16. *Sarah*, b. 1709.
 17. *Susannah*, b. 1712; m. *James Hibbert*.
 9. *DORCAS*, b. 1667; d. young. 10. *MARY*, b. Feb., 1667-8; d. young.
 11. *JOHN*, b. Oct. 23, d. Nov. 23, 1670.
-
5. 13 (II.) *JONATHAN PHILLIPS*, a Justice of the Peace, of Wat., m., Jan. 26, 1680-1, *SARAH HOLLAND*. [Holland, 5.] He appears to have lived on the homestead with his mother, and married in his 47th year, only five months before her decease. His Will was dated, Feb. 7, 1703-4; d. 1704. His wid. Sarah m., Feb. 27, 1716-17, *JOHN BEMIS*, Sen. [Bemis, 17.]
-
1. *SARAH*, b. Sept. 14, 1682; d. Nov., 1688.
 14 2. *ELIZABETH*, b. Nov. 27, 1684; m., Mar. 22, 1704-5, *JOHN ORMES*, q. v.
 15 3. *RUTH*, b. Mar. 28, 1687; m., Aug. 12, 1717, *EBENEZER HASTINGS*. [22.]
 16 4. *SARAH*, bap. Aug. 4, 1689; m. *JOHN BARNARD*. [22.]
 5. *ABIGAIL*, b. Ap. 22, 1693, d. young.
 72. 17 6. *JONATHAN*, bap. June 20, 1697; m., Feb. 27, 1716-17, *HEPZIBAH PARKER*.
 18 7. *HANNAH*, bap. Ap. 23, 1699; m., Sept. 7, 1727, *NATHANIEL DEWING*. Chil.,
 1. *Jemima*, b. Ap. 18, 1728. 2. *Hannah*, b. Oct. 19, 1731.
 3. *Nathaniel*, b. Dec. 18, 1739; m. (pub. Sept. 3), 1763; *Mary Collar*, of Needham.
 19 8. *GEORGE*, bap. Feb. 23, 1700-1; Daniel Harrington, of Wat., guardian.
 20 9. *NATHANIEL*, bap. May 2, 1703; John Fiske, guardian.
 10. *BENJAMIN*, bap. Ap. 8, 1705, d. young.
-
6. 21 (II.) *THEOPHILUS PHILLIPS*, of Wat., m., in Wat., Nov. 3, 1666, *BETHIA KEDAL* (? Kettle, or Kendal). She d. Mar. 15, 1668-9, and he m. (2d), Nov. 21, 1677, *MARY BENNET*. She, a wid., made her Will in Hopkinton, Dec. 3, 1730.
-
1. *BETHIA*, b. Dec. 21, 1668, d. young.
 (By 2d wife, Mary.)
 80. 22 2. *SAMUEL*, b. Feb. 20, 1679-80; of Weston; d. Nov. 9, 1752.
 23 3. *BENJAMIN*, of Waltham, m. *MARY* —, and d. 1740, a p.
 4. *MARY*, b. Sept. 16, 1684, d. next June.
 24 5. *MARY*, b. Nov. 15, 1685; m. — *COOK*, was a wid. 1740 (? sept of Andrew).
 25 6. *THEOPHILUS*, b. June 24, 1688; m., May 28, 1723, *ALICE COOK*, and settled in Hopkinton.
 26 7. *JONATHAN*, bap. July 13, 1690.
 27 8. *JOHN*, b. Dec. 10, 1692; m., Oct. 29, 1719, *REBECCA LIVERMORE*. [Livermore, 78.] Chil.,
 1. *John*, b. Jan. 23, 1720-1. 2. *Rebecca*, b. Nov. 8, 1722.
 28 3. *Priscilla*, bap. Nov. 26, 1724. 4. *Mary*, bap. June 4, 1726.
 30 Soon after this, he moved probably first to Lancaster, where he belonged in 1731, afterwards to Worcester, where he d. July 20, and his wid. Rebecca, d. Dec. 29, 1780.
 32 9. *ELIZABETH*, m., Nov. 7, 1716, *BENJAMIN EDDY*. [9.]
 33 10. *LYDIA*, b. June 20, 1695; m., 1725, *JONATHAN PRATT*, of Oxford, and d., leaving one child *Kezia*.
 35 11. *OBADIAH*, b. Feb. 22, 1697-8; his estate admin. by his brother John, Jan. 23, 1726.
 †91. 36 12. *JOSEPH*, b. Dec. 4, 1702.
 37 13. *DAVID*, b. Dec. 15, 1707; non-comp., under guardianship of his brother Theophilus; d. in Hop., Nov., 1740.
-
10. 38 (III.) *SAMUEL PHILLIPS*, a goldsmith, of Salem, m. (1st), May 26, 1687, *MARY EMERSON*, dr. of Rev. John and Ruth (Symonds) Emerson, of Gloucester, and a granddr. of Dep. Gov. Samuel Symonds, of Ipswich. [See Felt's Hist. of

- Ipswich, p. 163.] She d. Oct. 4, 1703, aged 42. He m. (2d), in 1704, wid. SARAH (Pickman) MAYFIELD. He d. Oct. 13, 1722, aged 65. Chil.,
1. PATIENCE, d. soon.
 - 91.39 2. SAMUEL, b. Feb. 17, 1689-90; grad. Harv. Coll., 1708; of Andover.
 - 40 3. SARAH, b. Jan. 28, 1691-2; m. WILLIAM WHITE, of Haverhill. [Phillips, App. I., White, 18.]
 - 41 4. MARY, b. Aug. 5, 1694; d. Oct. 5, 1785, aged 91; m. Capt. GEORGE ABBOT, of Andover. [Phillips, App. II., Abbot.]
 - 42 5. RUTH, b. Sept. 4, 1696; m. SAMUEL WHITE, of Haverhill. [Phillips, App. I., White, 26.]
 - 97.43 6. ELIZABETH, b. Mar. 5, 1698-9; d. Aug. 7, 1700.
 - 43 7. JOHN, b. June 22, 1701; of Boston.
(By 2d wife.)
 8. PATIENCE, b. Aug. 8, 1706; m. Rev. David Jewett. [See Phillips, App. III., Jewett.]
-
- 11.44 (III.) Rev. GEORGE PHILLIPS, grad. Harv. Coll., 1686, went to Jamaica, L. I., in 1693, and preached there until 1697, when he moved to Setauket, in the town of Brookhaven, L. I., where he d. Ap. 3, 1739. [One record says June 17.] He m. SARAH HALLETT, b. Mar. 19, 1673, dr. of William, Jr., and Sarah (Woolsey) Hallett, of Newton, L. I., and gr. dr. of William Hallett, an early and large proprietor, of Newton, opposite to Hell Gate, East River. He was not ordained [? installed] at Setauket, until after Oct., 1702. "His character and qualifications were of a high order, and his descendants are both numerous and respectable." "That he was a man of solid talents is generally believed, and possessed a happy vein of wit and humor, that rendered his company and conversation always agreeable." [See Thompson's Hist. of L. I., pp. 269, 270, and 387.] N.B. There was a George Phillips, proprietor, of Brookhaven, in 1657. [Thompson, p. 262.] Chil.,
- 45 1. GEORGE, b. Ap. 1, 1698; d. Nov. 16, 1771; m. ELIZABETH MILLS, of Smithtown, L. I., where he settled. She d. Ap. 11, 1768. Chil.,
 - 46 1. Samuel, b. Oct. 26, 1728; m., 1754, Sarah Mills, and d. June 3, 1806, aged 78. Chil.,
 - 47 1. Isaac Mills, b. June 18, 1760; m., Hetty Smith, d. Aug. 24, 1819, leaving one son, George S. Phillips.
 - 48 2. Sarah, b. Feb. 26, 1730.
 - 49 3. George, b. Jan. 16, 1732. Chil., 1. George. 2. Michael. 3. Deborah.
 - 50 4. Jonas, b. Mar. 18, 1735; m. Anna Lewis. Chil.,
 - 51 1. Anna, m. Daniel Phoenix. Chil., 1. Jonas Phillips. 2. Lewis.
 - 52 3. John D. 4. Daniel A. 5. Elizabeth, and 3 drs.
 - 52 5. Elizabeth, b. Mar. 23, 1737. 6. Mary, b. Ap. 15, 1741.
 - 54 7. Moses, b. Mar. 8, 1742-3; d. Sept. 9, 1818; m., Jan. 27, 1760, Sarah Wisner. He settled in Phillipsburg, N. Y. Chil.,
 1. Gabriel Newton. 2. George. 3. Henry Wisner. 4. Moses.
 5. William. 6. Sarah. 7. Samuel. 8. Elizabeth.
 - 55 2. SAMUEL, d. young. 3. ELIZABETH. 4. DANIEL.
 - 57 5. WILLIAM, m., Oct. 27, 1737 (? 36), SYBIL SMITH, and settled in Smithtown, L. I. He d. Jan. 1, 1778, and she d. Oct. 31, 1767, aged 74. Chil.,
 - 58 1. John, b. Sept. 3, 1737; d. in Milford, Conn., Mar. 12, 1780.
 - 59 2. William, b. May 27, 1741; d. in Brook Haven, Mar. 27, 1799, leaving son William.
 - 60 3. Richard. 4. Mary.
 - 62 5. Zebulon, b. Ap. 14, 1746; d. in Peekskill, N. Y., Jan. 13, 1815.
 - 63 6. James, b. Mar. 13, 1751; d. in Coventry, N. Y., Jan. 25, 1841.
 - 64 7. Ebenezer, b. July 15, 1753; m., Jan. 17, 1782, Mary Benedict, of Norwalk, Conn., where he settled, and where he d., Aug. 5, 1829. Chil.,
 1. Esther, b. Mar. 5, 1787; d. Feb. 5, 1788. 2. Esther, b. Ap. 17, 1788.
 3. Sally, b. Dec. 11, 1790. 4. Elizabeth, b. July 9, 1798.
 - 65 8. Sarah, b. Oct. 24, 1756; d. in North Salem, N. Y., Feb. 12, 1827.
 - 66 9. Philetus, b. Nov. 24, 1759; d. in Greenville, N. Y., May 17, 1818.
 - 67 1. Ebenezer, minister, of E. Hampton, d. 1830.
 - 68 10. Elizabeth, b. Nov. 9, 1762; d. in Brook Haven, Feb. 4, 1844.

- 69 6. JOHN, b. 1715; grad. Harv. Coll., 1734; kept school in several places; studied divinity and preached, but probably never had a pastoral charge; in 1744, was appointed Chaplain to Gen. Winslow's Brigade, and was at the siege and capture of Louisburg; soon afterwards appointed by Gov. Shirley, Chaplain of Castle William and Mary, in Boston Harbor, which he held to the close of Gov. Pownall's administration, upon whose recommendation, his successor, Gov. Barnard, appointed him Commander of the Castle, the office having become vacant in 1761, by the death of Capt. Larrabee. In 1772, amid the difficulties between the colonies and the mother country, Major Phillips was removed from this command, by Gov. Hutchinson; but he continued to receive pay until the commencement of hostilities, in 1775. He married, Oct. 26, 1762, MARY WINTHROP, dr. of Col. Adam and Anne Winthrop, of Boston, and a sister of John Winthrop, LL.D., F.R.S., the distinguished Professor of Nat. Philosophy, in Harv. College. He died Jan. 9, 1787, and his wid. Mary, d. Nov. 15, 1794. Only one child, viz.,
- 70 *Mary*, b. Sept. 23, 1763; m., Oct. 21, 1788, Dr. *William Spooner*, of Boston. [See Phillips, App. IV., Spooner.]
-
17. 72 (II.) JONATHAN PHILLIPS, m., in Wat., Feb. 27, 1716-17, HEPZIBAH PARKER, of Wat. [Her father, Stephen Parker, son of Joseph Parker, of Newbury [see Coffin, p. 313], moved from Newbury to Watertown, where he d. May 2, 1718, aged 62 yrs. and 2 m., and his wid. Susanna d. there, May 5, 1718, aged 58 years and 2 months]. About 1719, he, by trade a carpenter, moved to Marblehead. About 1740, he went to Newport, R. I., where he generally resided afterwards, and where he died. Chil.,
-
106. 73 1. STEPHEN, b. July 18, 1718, of Marblehead.
 74 2. a daughter, m. — DEVEREUX, of Marblehead, and had chil.
 75 3. another dr. went South, and carried the family records, which have not been recovered.
 76 4. RUTH, b. 1735; m. (1st), — EDWARDS. She m. (2d), NICHOLAS TILLINGHAST. [See Phillips, App. V., Tillinghast.]
 77 5. several other children, of whom no record has been obtained.
-
22. 80 (III.) SAMUEL PHILLIPS, of Weston, m., Feb. 12, 1710-11, DEBORAH DIX [Dix, 11]. He d. Nov. 9, 1752. Chil.,
- 81 1. DEBORAH, b. Dec. 15, 1711; m., May 30, 1737, DANIEL WARREN [40].
 82 2. SAMUEL, b. Sept. 14, 1713; m., July 25, 1735, ABIGAIL GALE, of Wat. [Gale, 36]. She was dismissed to Fram. Mar. 5, 1747-8.
 83 1. *Abigail*, b. Mar. 7, 1736-7.
 84 3. MARY, bap. Sept. 23, 1716, d. young.
 84 4. LYDIA, b. June 27, 1719; m., Mar. 7, 1754, DAVID SHERMAN, of Sud.
 85 5. EBENEZER, b. Feb. 19, 1721-2, of Weston; m., Ap. 27, 1749, MARY WARREN, of Waltham [Warren, 76]. Chil.,
 86 1. *Ruth*, b. May 27, 1750.
 87 2. *Mary*, b. May 21, 1752; m., Aug. 5, 1773, *Samuel Poole*, of Boston.
 88 3. *Samuel*, b. May 15, 1754. 4. *Eunice*, b. Mar. 20, 1756.
 90 5. *Ebenezer*, b. Feb. 18, 1758.
-
36. †91 (III.) JOSEPH PHILLIPS settled in Oxford, where tradition says he m. RUTH TOWNE, and d. 1772. Chil.,
- †92 1. JONATHAN, b. Aug. 12, 1732; m. RACHEL, dr. of Dea. Humphrey, of Oxford, and settled in Sturbridge, where he became a large land owner, and a deacon of the Baptist Church. He d. June 6, 1798. Chil.,
- †93 1. *Ebenezer Humphrey*, b. July 17, 1756, studied medicine with Dr. Thomas Babbit, of Sturbridge, and settled in Charlton, Mass., a very active business man. "At the age of fifty, he was attacked with paralysis so severely, that for two years he could not walk, nor speak so as to be understood. After the end of the third year, he began to mend, but his memory was gone. He, however, began to be conscious of his condition, and the thought of leading a useless life he could not endure. Usefulness was his theme: 'What can I do?' His old profession seemed most desirable, and he

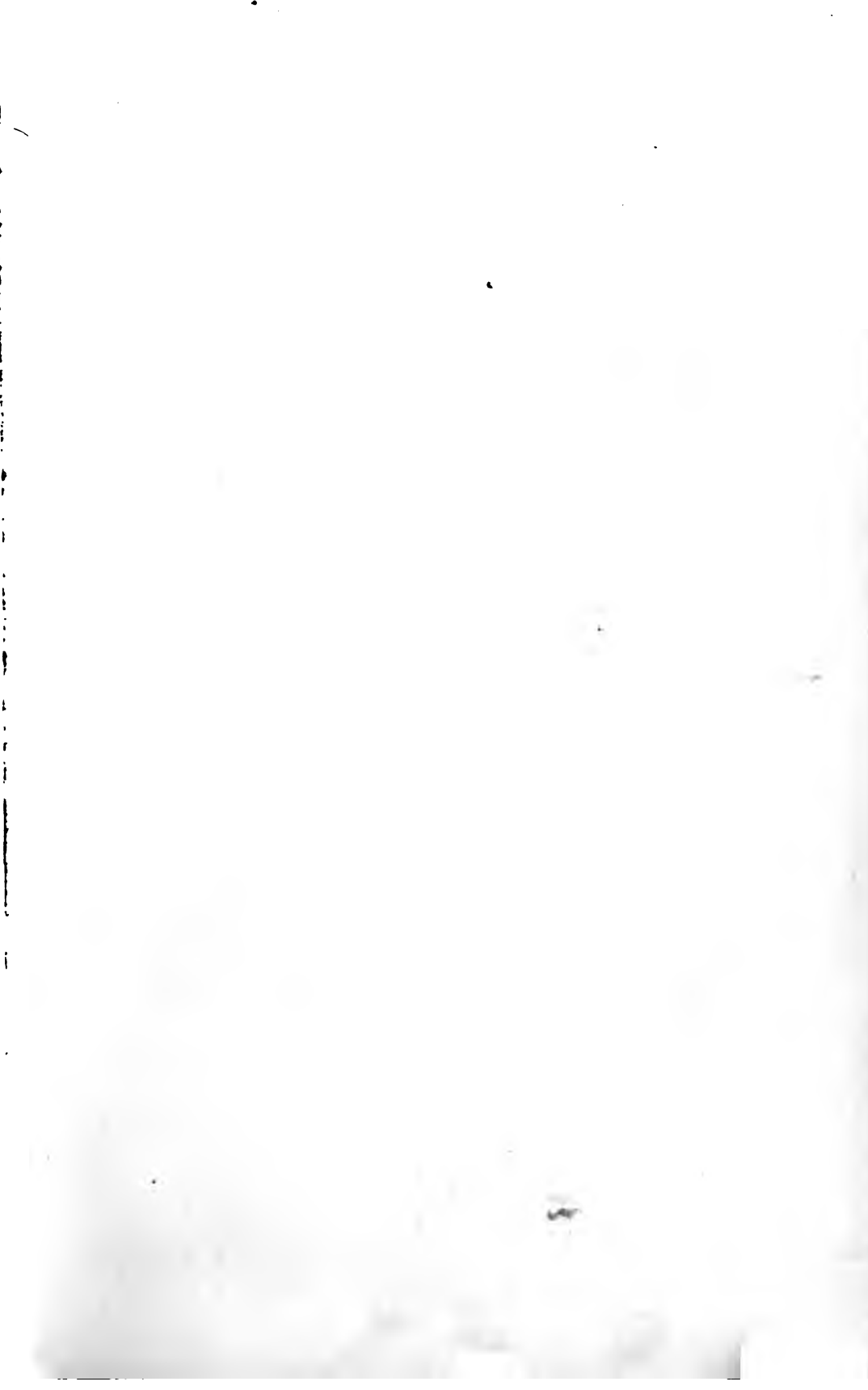



J. Phillips





commenced reading regularly a second time, all being as new to him as when read nearly thirty years before. When he had read nearly a year, memory flashed upon him like lightning, and he exclaimed, 'I have read this before.' From that time, for thirty-two years, he was a useful, and perhaps as successful a physician as any of his associates." He m. *Ruth Morgan*. He d. of a second attack of palsy, Dec. 1, 1838. Chil.,

- †94 1. Ebenezer Morgan, b. Feb. 19, 1792; of Westboro; m., Oct. 12, 1818, Anna Maria Brigham, b. July 14, 1794, dr. of Hon. Elijah and Sarah (Ward) Brigham, of Westboro, and gr. dr. of Gen. Artemas Ward. [See Ward Family, p. 87]. Chil.,
- †95 1. Elijah Brigham, b. Aug. 20, 1819, now (1854), of Cleveland, O.; m., Feb. 2, 1845, Maria R., dr. of Henry Ayling, of Rox., from England.
- †96 2. Harriet Maria, b. Aug. 8, 1824; m., Ap. 2, 1850, Rev. Edward W. Clarke, of Reading.

39. 91 (IV.) Rev. SAMUEL PHILLIPS, grad. Harv. Coll. 1708; kept school a year at Chebacco (now Essex), began to preach in the South Parish of Andover, in 1710, was ordained there Oct. 17, 1711, and he continued the pastor thereof until his decease, June 5, 1771, in the 60th year of his ministry. He preached the election sermon in 1750, and "his publications are numerous, and frequently met with." He was "an excellent man, so economical, it is said, as to blow out the candle when he began his evening prayer, and yet punctilious in distributing among the poor a full tenth of his income, of which he kept account." He m., Jan. 17, 1711-12, HANNAH WHITE, dr. "of the worshipful John White, Esq.," of Haverhill, a deacon of the church, and captain of the company in said town. She d. Jan. 7, 1773. [See 7, p. 887.] Chil.,

of a affectionate Father
S. Phillips

- 92 1. MARY, b. Nov. 30, 1712; m., Oct. 12, 1736, SAMUEL APPLETON, of Haverhill. She d. in childbed, Nov. 24, 1737, aged 25. Her only child still-born.
- 113. 93 2. SAMUEL, b. Feb. 13, 1715; grad. Harv. Coll. 1734, d. Aug. 21, 1790.
- 94 3. LYDIA, b. June 10, 1717; m., May 18, 1742, Dr. PARKER CLARK, of Newbury (or Andover). She d. Nov. 4, 1749, aged 32 yrs. Chil.,
 - 1. Hannah, b. Ap. 2, 1743; m., July 23, 1767, Dr. Edward Russell, of North Yarmouth, Me., and had one child.
 - 1. Hannah, b. July 2, 1768, d. May 3, 1851, aged 83.
 - 2. Lydia, b. Aug. 16, 1744. 3. Elizabeth, b. Aug. 18, 1746.
 - 4. Parker, b. Ap. 3, 1748.
- 116. 95 4. JOHN, b. Dec. 27, 1719, grad. Harv. Coll. 1735, d. Ap. 21, 1795.
- 117. 96 5. WILLIAM, b. July 6, 1722, d. in Boston, Jan. 15, 1804.

43. 97 (IV.) Hon. JOHN PHILLIPS, of Boston, deacon of Brattle St. Church, colonel of the Boston Regt., a Justice of the Peace and of the Quorum, Rep. of Boston several years. He served an apprenticeship with Col. D. Hinchman, a stationer, of Boston, which business he followed some time, and then engaged in mercantile pursuits, in which he was very successful. He was much devoted to works of benevolence. He m. (1st), Nov. 21, 1723, MARY BUTTOLPH, b. May 8, 1703, dr. of Nicholas Buttolph, of Boston. She d. Aug. 15, 1742, and he m. (2d), ABIGAIL WEBB, dr. of Rev. Mr. Webb, of Fairfield, Conn. He d. Ap. 19, 1768, and was buried with military honors. In 1725, his direction was "Stationer's Arms, Cornhill." "Besides a considerable trade as a publishing bookseller and binder, he was a dealer in English goods, according to the customs of those times." [Thomas's History of Printing, &c., II., p. 429.] Chil.,

- 98 1. JOHN, b. Nov. 29, 1726; m. ELIZABETH GREEN, and had one daughter, who m. ——— Thurston.
- 99 2. SAMUEL, b. Mar. 15, 1729; m. ELIZABETH FAYERWEATHER. Chil.,
 - 100 1. daughter, m. ——— Clarke.
 - 101 2. daughter, m. Henry Prentice.

- 102 3. ABIGAIL, b. Feb. 14, 1733; m. Col. ELISHA PORTER, of Hadley. [See Phillips, App. III. Jewett, 3.]
- 103 4. SARAH, b. Ap. 7, 1735; m. NATHANIEL TAYLOR, a merchant, of Boston, son of Rev. Mr. TAYLOR, of Milton.
122. 104 5. WILLIAM, b. Aug. 29, 1737, d. June 4, 1772.
- 105 6. MARY ANN, b. July 25, 1741; m. Dr. NATHANIEL NOYES, and d. Ap. 20, 1791. (By 2d wife, Abigail.)
- 105½ 7. JOSEPH.
-
73. 106 (IV.) Dea. STEPHEN PHILLIPS, of Marblehead, whither his father had moved from Wat. in his infancy. He was for many years a dea. of the Cong. Church, was at the head of the Committee of Safety, and an influential leader in the Revolution. He m. ELIAZBETH ELKINS. He d. Mar. 1, 1801, and his wid. d. Sept. 30, 1803.
- 107 1. MARY, b. Aug. 22, 1755; m. THOMAS MEEK, who d. in 1812, and she d. Aug., 1844, s. p.
- 108 2. ELIZABETH, b. Nov. 28, 1757; m. Capt. JOB GRISTE. She d. 1835, s. p.
- 109 3. SARAH, b. Feb. 23, 1760, d. 1834, unm.
126. 110 4. STEPHEN, b. Nov. 13, 1761, d. Oct. 19, 1838, of Marblehead and Salem.
- 111 5. LYDIA, b. Jan. 17, 1767, d. Sept. 10, 1794, unm.
139. 112 6. WILLIAM, b. Nov. 15, 1769, of Fredericksburg, Va.
-
93. 113 (V.) Hon. SAMUEL PHILLIPS, of Andover, grad. Harv. Coll. 1734. After teaching a grammar school some time, he engaged in mercantile business in the North Parish of Andover. In the winter of 1775-6, he was engaged in the manufacture of gunpowder, and built a mill at great expense, which was blown up in 1778, and three persons killed. In 1788, he built a paper-mill, which was carried on by Phillips and Houghton. He was often the Representative of Andover, and member of the Executive Council before the Revolution, and in the Revolution was a staunch whig; was many years a civil magistrate, discharging the duties thereof with the most exemplary fidelity. Such were the sternness and precision of his manners, always frowning on vice and disorder, that they did not contribute to his popularity. Early habits of exactness and economy in business enabled him to accumulate a large estate, much of which he appropriated to the public good. In 1778, Phillips Academy, in Andover, was founded by him and his brother, Hon. John Phillips, of Exeter, by the gift to the Board of Trustees of several valuable tracts of land, and £1614 in money. In the constitution of the Academy, the founders declare that "the first and principal object of their institution is the promotion of true piety and virtue."

Your affectionate Father
Samuel Phillips

He m., July 11, 1738, ELIZABETH BARNARD, the only surviving child of Theodore Barnard, of Andover. [He (T. B.) was the youngest son of the venerable Thomas Barnard, minister of North Andover, grad. 1679, d. 1718, and a brother of Rev. John Barnard, grad. Harv. Coll. 1709, d. 1757, who was successor of his father, and father of Rev. Edward Barnard, of Haverhill, grad. Harv. Coll. 1736, d. 1774. The property in North Andover now owned and occupied by the Phillips family, came by the Barnard family.] "Her letters are very interesting, and show her to have been a woman of great piety, and strong religious views." An obituary notice of her in the Sentinel, in Nov. 1789, closes thus:

"Think what the mother, Christian, friend, should be,
 You've then her character, for such was she."

(EPITAPH.)

"In Memory of

SAMUEL PHILLIPS, Esq.,
 who died Aug. 21, 1790, aged 76, and
 Mrs. ELIZABETH PHILLIPS, his consort,
 who died Nov. 29, 1789, aged 71.

Mr. Phillips sustained various public
 offices with fidelity.

This pair were friends to order in the
 Family, Church, and Commonwealth;
 Examples of Industry and Economy,
 and Patrons of Learning and Religion."

Chil.,

- 114 1. THEODORE, b. May 2, 1739; d. Jan. 25, 1740.
 2. HANNAH, b. Jan. 20, 1742; d. June 15, 1764.
 3. SAMUEL, b. Nov. 6, 1743; d. Dec. 24, 1744.
 4. THEODORE, b. Sept. 6, 1745; d. Dec. 1, 1758.
 5. ELIZABETH, b. Oct. 31, 1747; d. June 24, 1748.
 143. 115 6. SAMUEL, b. Feb. 7, 1752; grad. Harv. Coll., 1771; d. Feb. 10, 1802.
 7. ELIZABETH, b. Oct. 18, 1755; d. Ap. 19, 1757.

95. 116 (V.) Hon. JOHN PHILLIPS, of Exeter, grad. Harv. Coll., 1735; LL.D., Dart. Coll., 1777. After teaching a public school some time in Andover, and other towns, he went to Exeter, and taught a private Latin school. He studied Theology, and on the 25th of May, 1747, he (then a ruling elder) received an invitation to become the pastor of the church in Exeter. A correspondent says, "I have the almanacks of Rev. J. Phillips, from 1739 to 1746 inclusive, but it is not known that he ever accepted a pastoral charge, or was ordained." He engaged in mercantile pursuits, in which he was very prosperous. He was a Justice of the Peace, and "was authorized to be, in some singular cases, one of the Judges of the Superior Court." He was a trustee of Dart. Coll., 1773 to 1793, and founded and endowed in that College, the Phillips Professorship of Theology. He aided his brother in founding Phillips Academy in Andover, and made it a bequest (one-third of his estate), amounting to twenty thousand dollars. He was the liberal founder of Phillips Academy in Exeter, and bequeathed to it two-thirds of his large estate. He m. (1st) SARAH, wid. of Nathaniel Gilman, Esq., and dr. of Rev. Mr. Emery, of Wells. He m. (2d), 1767, ELIZABETH, wid. of Dr. Hale, and dr. of Hon. E. Dennet, of Portsmouth, N. H. He d. Ap. 21, 1795, s. p.

very affectionately yours
John Phillips

96. 117 (V.) Hon. WILLIAM PHILLIPS, of Boston. At the age of 15 years, he went to Boston, and became apprentice to Edward Bromfield, Esq., a highly respectable merchant of that town, son of Hon. Edward Bromfield, for many years one of his Majesty's Council, in the Province of Massachusetts Bay, and a great grandson of Rev. John Wilson, the first minister of Boston. At the termination of his apprenticeship, he m., June 13, 1744, o. s. ABIGAIL BROMFIELD, eldest daughter of his late master, and engaged in mercantile pursuits, in which he was very successful. [By this marriage, a great grandson of the first minister of Water-town, was united with a great granddaughter of the first minister of Boston.] He was for many years a deacon of the Old South Church; and was repeatedly elected Representative and State Senator. "He took a decided and active part in the proceedings which preceded and attended the Revolution; was on many of the committees appointed by the town of Boston, in those trying times, and often contributed liberally of his estate to promote the measures, which issued in the establishment of our independence." He was one of the committee sent to demand of Gov. Hutchinson, that the tea should be sent back to England;

was rejected, as a Councillor, by Gov. Gage; was a member of the Convention for framing the Constitution of the Commonwealth, and of that, adopting the Constitution of the United States. Upon the outbreak of the Revolution, he moved his family to Norwich, Conn., where they remained, while the British had possession of Boston, occupying the Arnold Mansion, the same house in which the traitor, Benedict Arnold, was born. He bequeathed five thousand dollars to Phillips Academy, in Andover. He d. Jan. 15, 1804, aged 82. Chil.,

*Y^e Loving Bro?
W^m Phillips*

- 118 1. ABIGAIL, b. Ap. 14, 1745; d. Mar. 25, 1798; m. JOSIAH QUINCY, Jr., of Revolutionary fame. [See Phillips, App. VI., Quincy.]
2. WILLIAM, d. young.
146. 119 3. WILLIAM, b. Mar. 30, 1750; Lt. Gov.; d. May 26, 1827.
4. SARAH, d. young. 5. HANNAH, d. young.
- 120 6. HANNAH, b. Nov. 29, 1756; m. SAMUEL SHAW, s. p.
- 121 7. SARAH (twin), b. Nov. 29, 1756; m. EDWARD DOWSE, of Dedham; and d. 1839, s. p.
8. MARY, d. young.
-
104. 122 (V.) WILLIAM PHILLIPS, of Boston, m., June 12, 1761, MARGARET WENDELL, b. Aug. 20, 1739, 11th and youngest child of Hon. Jacob Wendell. [Mr. Wendell was a merchant, Colonel of the Boston Regiment, and one of the Governor's Council. He m., Aug. 12, 1714, Sarah Oliver, bap. Dec. 20, 1696, dr. of Dr. James Oliver, of Cambridge, who m. Mercy Bradstreet, dr. of Dr. Samuel and Mercy (Tyng) Bradstreet, of Camb., and granddr. of Gov. Simon Bradstreet, by his first wife Anne, dr. of Gov. Thomas Dudley.] He d. June 4, 1772, aged 34 yrs. 9 m. His wid. d. Feb. 27, 1823. Chil.,
-
- 123 1. MARGARET, b. May 25, 1762; d. Feb. 19, 1844; m. Judge SAMUEL COOPER.
124 2. SARAH, b. Ap. 6, 1765; m. MARK NEWTON, of Andover.
168. 125 3. JOHN, b. Nov. 26, 1770; grad. Harv. Coll. 1788; d. May 29, 1823.
-
110. 126 (V.) STEPHEN PHILLIPS. In early life, and in the infancy of the trade between the United States and the E. Indies, he made several voyages in command of vessels of the late Elias Hasket Derby, Esq., of Salem. In 1800, he moved from Marblehead to Salem, where he engaged in commercial life. He m. (1st), in 1800, DORCAS WOODBRIDGE, b. Ap. 1, 1774, dr. of Dudley Woodbridge, of Salem. She d. June 15, 1803, and he m. (2d) ELIZABETH PEIRCE, b. Mar. 1, 1774, dr. of Nathan Peirce, of Salem. He d. Oct. 19, 1838, and his wid. now (1855) resides in Salem. Chil.,
-
- 127 1. STEPHEN CLARENDON, b. in Salem, Nov. 4, 1801; grad. Harv. Coll., 1819; a counsellor at law, of Salem; Rep. in Congress, from Essex, South District, 1834-38; Mayor of Salem, 1838-42; overseer of Harv. College. He m. (1st), Nov. 6, 1822, JANE APPLETON PEELE, dr. of Willard Peele, of Salem. She d. in childbed, Dec. 19, 1837, and he m. (2d), Sept. 3, 1838, MARGARET MASON PEELE, sister of his first wife. Chil.,
- 128 1. *Stephen Henry*, b. Aug. 16, 1823; grad. Harv. Coll., 1842; a counsellor at law, of Salem; editor of the Law Reporter, 1847-51; District Attorney, of Eastern Criminal District of Mass., since 1851.
- 129 2. *Willard Peele*, b. Sept. 7, 1825; merchant, in Salem; m., May 22, 1850, *Mary Hodges*, dr. of Francis Boardman, Esq., of Salem. Chil.,
1. *Jane Appleton*, b. Jan. 16, 1852.
- 130 3. *George Wilham*, b. Nov. 27, 1827; grad. Harv. Coll., 1847; Civil Engineer; resident of Three Rivers, C. E.
- 131 4. *Elizabeth Griste*, b. Ap. 10, 1831.
- 132 5. *Jane Peele*, b. Feb. 24, 1833.
- 133 6. *Margaret Peele*, b. June 30, 1835.
- 134 7. *Abbott Lawrence*, b. Dec. 7, 1837.
(By 2d wife.)
- 135 8. *Walter Mason*, b. May 26, 1839.

- 136 9. *Charles Appleton*, b. Jan. 30, 1841.
- 137 10. *Edward Woodbridge*, b. Aug. 3, 1842.
- 138 11. *Catherine*, b. July 7, 1844.

112. 139 (V.) WILLIAM PHILLIPS, m., 1799, ELIZABETH EMERSON. He d. in Fredericksburg, Va., in 1805. Chil.,

- 1. MARY, d. 1809.
- 140 2. ELIZABETH, b. June 1, 1805; m. (1st), June 1, 1821, Capt. — PAULL, of Fredericksburg, Va. He d. 1835, and she m. (2d), May 18, 1837, ROBERT DICKEY, of Fredericksburg, Va. Chil.,
 - 1. *Mary Ellen* (Paull), b. Dec. 26, 1822; d. May 6, 1830.
 - 2. *Maria Elizabeth* (Paull), b. Aug. 9, 1823; d. Mar. 6, 1833.
- 141 3. *Annie Carter* (Paull), b. May 13, 1831.
- 142 4. *Ellison* (Dickey), b. Feb. 26, 1838; d. Dec. 7, 1839.
- 5. *John* (Dickey), b. Dec. 22, 1839.

115. 143 (VI.) Hon. SAMUEL PHILLIPS, of Andover; grad. Harv. Coll., 1771; was member of the Provincial Congress held in Watertown in 1775, and afterwards until 1780; was on the most important committees during the Revolutionary war; a member of the Convention in 1779, for forming the State Constitution; a State Senator, from 1780 to 1801, with the exception of one year, when he was employed on a public mission, having reference to the suppression of Shay's Rebellion. He was chosen President of the Senate, in 1785, and held the office fifteen years, until 1801, when he was elected Lieut. Governor. He was a Justice, C. C. P., from 1781 to 1797, when declining health and the fatigue of the duties, induced him to resign the office. He was one of the original members of the Am. Acad. of Arts and Sciences, instituted in 1780, and was made LL.D. Harv. Coll., 1793. He made large donations to Phillips Academy, Andover, and to various pious and charitable uses. He d. Feb. 10, 1802, aged 52. Upon his decease, numerous funeral sermons were preached, and several were printed, abounding in encomiums upon his character and services.

He m., June, 1773, PHEBE FOXCROFT, b. Aug. 12, 1743, dr. of Hon. Francis Foxcroft, of Cambridge. She d. Oct. 7, 1812, aged 69. She has been described as a lady of a highly cultivated mind, a brilliant imagination, pleasant wit, and happy conversational powers. Chil.,



- 203. 144 1. JOHN, b. Oct. 18, 1776, grad. Harv. Coll. 1795; a colonel, of Andover.
- 145 2. SAMUEL, d. 1796.

119. 146 (VI.) Lieut. Gov. WILLIAM PHILLIPS, of Boston. Owing to the feebleness of his health in early life, he did not receive a collegiate education. During the occupancy of Boston by the British troops, he resided in Norwich Conn., with the other members of his father's family. Upon the decease of his father, he came into possession of an ample fortune, to the management of which, and to the duties of his family and of friendship, to the service of the public, and to deeds of benevolence,* he was thenceforth chiefly devoted. He was eminently a domestic

* At the time of his decease, he was president of the Am. Education Society; of the Mass. Bible Society; of the Society for propagating the Gospel; of the Foreign Mission Society of Boston and vicinity; of the Cong. Charitable Society; of the General Hospital Corporation; of the Boston Dispensary; and was Hon. Vice-President of several other benevolent associations in Boston, and in other parts of the country. He was a liberal contributor to numerous charitable objects, and for a series of years his benefactions amounted to from eight to eleven thousand dollars a year. His benefactions by his Will to various public charities were as follows:

Phillips Academy, Andover,	\$15,000	Boston Medical Dispensary,	3,000
Theological Seminary, Andover,	10,000	Massachusetts General Hospital,	5,000
American Education Society,	5,000	Boston Female Asylum,	2,000
Society for propagating the Gospel,	5,000	Asylum for Indigent Boys,	2,000
Massachusetts Bible Society,	5,000		
American Board of Commissioners,	5,000		
Massachusetts Cong. Charitable Society,	5,000		
			\$62,000

[For more full details of his character and life, and the encomiums which he so well deserved, see the Funeral Sermon of Rev. B. B. Wisner, June 8, 1827, and Am. Quarterly Register, vol. xiii, pp. 9-17.]

man, fond of retirement, and of the society of his family and intimate friends. Yet he was not averse to the calls of public duty." For many years he was Representative in the State Legislature, and he was repeatedly chosen an elector at large of President and Vice-President of the United States. For several years he was Lieut. Governor of the State, enjoying very fully the friendship and confidence of Governors Strong and Brooks. He was admitted f. c. into the Old South Church, June 21, 1772, and was elected deacon thereof, Mar. 24, 1784, which office he held until his decease. He m., Sept. 13, 1774, MIRIAM MASON, b. June 16, 1754, 3d dr. of Hon. Jonathan Mason, of Boston; a lady distinguished for intelligence and discretion, eminent for piety and benevolence. She d. May 7, 1823, greatly lamented, and he d. May 26, 1827. Chil.,

1. WILLIAM WILSON, b. in Norwich, Dec. 10, 1775, d. Jan. 1, 1784.
2. JONATHAN, b. May 2, d. Oct. 27, 1777.
- 147 3. JONATHAN, b. Ap. 24, 1778; of Boston; State Senator; Hon. A. M. Harv. Coll. 1818; m. (1st), Sept. 30, 1805, REBECCA SALISBURY, b. Aug. 16, 1776; dr. of Samuel Salisbury, of Boston. She d. Mar. 13, 1828, and he m. (2d), Aug. 27, 1839, MARY MAGEE, b. Mar. 19, 1791, dr. of James and Margaret Magee. She d. June 23, 1849. Chil.,
 1. *Martha Salisbury*, b. Dec. 28, 1806, d. Mar. 24, 1839.
 2. *Jonathan Mason*, b. Ap. 24, 1810, d. Oct. 21, 1811.
 3. *Miriam*, b. July 2, 1811, d. Dec. 19, 1816.
 4. *Rebecca Salisbury*, b. Oct. 19, 1816, d. Nov. 15, 1832.
 - 148 5. *William*, b. Jan. 11, 1819.
- 149 4. MIRIAM, b. June 9, 1779; m., Jan. 4, 1803, SAMUEL HALL WALLEY, b. Ap. 12, 1778, d. July 25, 1850. She d. Mar. 26, 1827. Chil.,
- 150 1. *Samuel H.*, b. Aug. 31, 1805; grad. Harv. Coll. 1826; Counsellor-at-law; Speaker of Mass. H. Rep.; m., Oct. 14, 1829, *Mehitabel Sumner Bates*, b. June, 1810, dr. of Hon. Isaac C. Bates, of Northampton. Chil.,
 1. *Martha Henshaw*, b. Dec. 17, 1832, d. Feb. 15, 1833.
 - 151 2. *Miriam Phillips*, b. Aug. 28, 1834.
 - 152 3. *Samuel*, b. Sept. 3, 1836, d. Sept. 13, 1837.
 - 152 4. *Henshaw Bates*, b. Sept. 14, 1838.
 - 153 5. *Theresa Maria*, b. Oct. 26, 1840, d. Aug. 9, 1843.
 - 154 6. *William Phillips*, b. Ap. 11, 1843.
 - 154 7. *Abigail Bromfield Phillips*, b. Sept. 4, 1845.
 - 155 8. *Hetty Sumner Bates*, b. Feb. 15, 1848.
 - 156 9. *Isaac Chapman Bates*, b. Jan. 15, 1850.
 - 157 10. *Edward*, b. June 6, 1852.
 - 158 2. *Sarah Hurd*, b. Jan. 18, 1816; m. *Wm. K. Brown* [Brown, 279].
 - 158 3. *Abigail Bromfield Phillips*, b. May 25, 1818, unm.
 - 159 5. EDWARD, b. June 24, 1782, of Boston, a Dea. of Old South Church; m. (1st), 1807, MARY SALISBURY, b. May 18, 1787, d. Ap. 28, 1815. He m. (2d), Nov. 3, 1820, THERESA HENSHAW, of Northampton. He d. Nov. 4, 1826, and his wid. m. Dr. C. Beck, Prof. Harv. Coll. Chil.,
 1. *William*, b. Aug. 8, 1808, d. Jan. 13, 1829.
 2. *Edward*, b. July 6, 1810, d. Feb. 15, 1812.
 - 160 3. *Abby*, b. Nov. 3, 1814; m., Ap. 27, 1836, *Edward Elbridge Salisbury*, grad. Yale Coll. 1832, and professor there since 1841.
(By 2d wife.)
 4. *Miriam M.*, b. Aug. 5, 1821, d. Feb. 22, 1824.
 5. *Edward B.*, b. Oct. 5, 1824, grad. Harv. Coll. 1845, d. June 21, 1848, bequeathing \$100,000 to Harv. Coll., for the Observatory.
 - 161 6. *Theresa Henshaw*, b. Aug. 22, 1826.
 - 162 6. ABIGAIL BROMFIELD, b. Feb. 5, 1790; m. Rev. EBENEZER BURGESS; grad. Br.





H. W. Smith, Sr.

.....

201 | 8. WENDELL, b. Nov. 29, 1811, grad. Harv. Coll. 1831; LL.B. 1834; a counsellor
at-law; now (1853), of Florence, Mass.; m., Oct. 1837, MARY ANN GREENE, d.
of Benjamin Greene, of Boston, s. p.

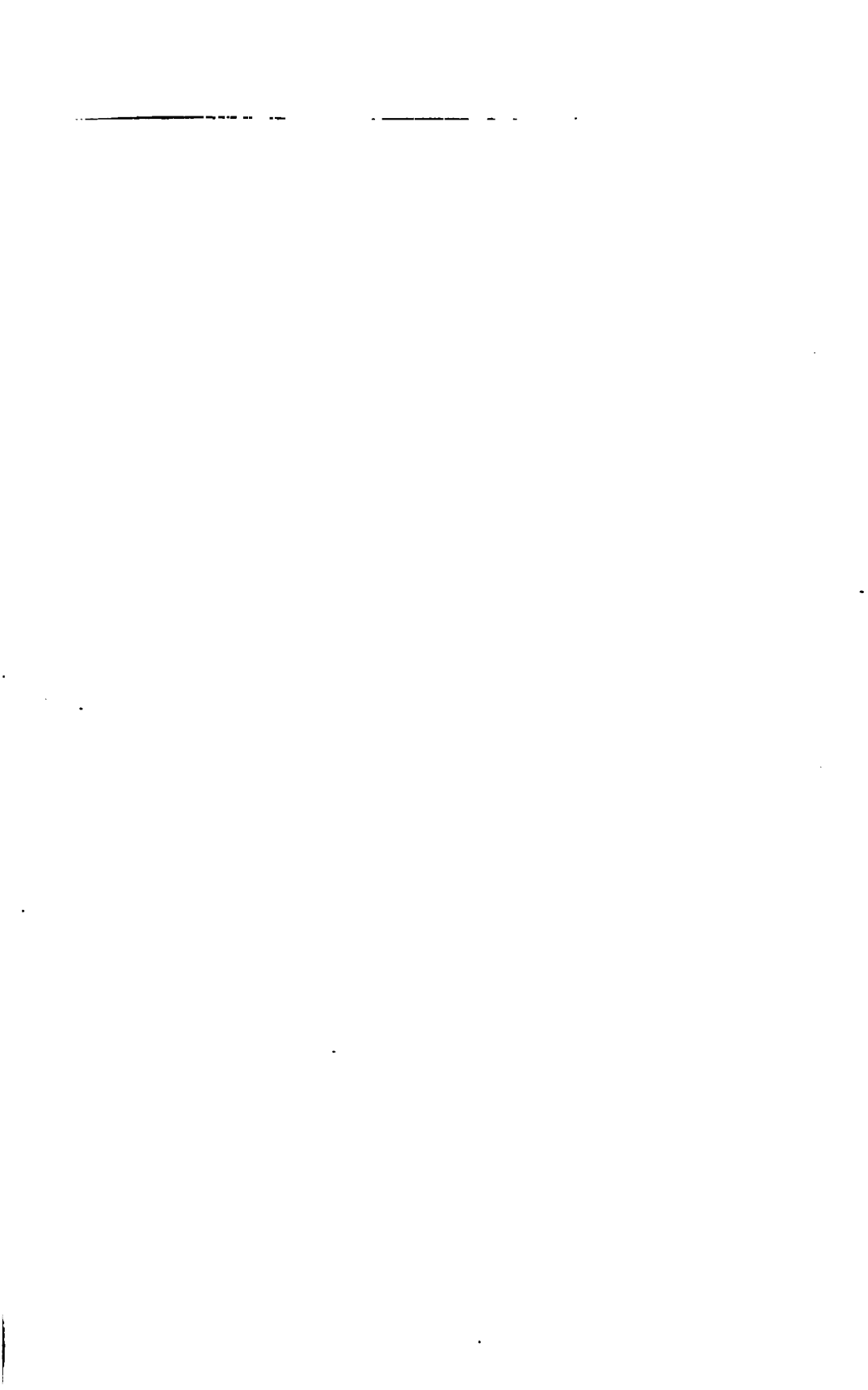

- Univ. 1809; some time President of Vt. Univ.; D.D. Mid. Coll. 1835; now of Dedham, Chil.,
 1. *Miriam Mason*. 2. *Ebenezer Prince*.
 3. *Edward Phillips*. 4. *Martha Crossell*.
- 167 7. WILLIAM, b. Oct. 13, 1791.
-
125. 168 (VI.) Hon. JOHN PHILLIPS, of Boston, grad. Harv. Coll. 1788, and fellow thereof 1812 to 1823; President of the Senate of Massachusetts, and first mayor of Boston. He m., Dec. 18, 1794, SALLY WALLEY, b. Mar. 25, 1772, dr. of Thomas and Sarah (Hurd) Walley. He d. May 29, 1823, and his wid. d. Nov. 4, 1845. Chil.,
- 169 1. THOMAS WALLEY, b. Jan. 16, 1797, grad. Harv. Coll. 1814; Clerk of the Boston Municipal Court since 1830. He m., Mar. 18, 1824, ANNA DUNN, dr. of Samuel Dunn, of Boston. Chil.,
 1. *John*. 2. *Samuel*.
- 170 2. SARAH HURD, b. Ap. 24, 1799; m. (1st), Ap. 24, 1823, FRANCIS JENKS, Jr., b. Aug. 11, 1798. He d. 1837, and his wid. m., in 1840, Prof. ALONZO GRAY, of Brooklyn, N. Y. Chil.,
 1. *Mary Elwell* (Jenks), b. June, 1824; m. Rev. R. S. Storrs, of Brooklyn, New York.
 2. *John Phillips* (Jenks), b. 1826, d. 1828.
 3. *Francis* (Jenks), b. Oct. 1828.
 4. *Grenville Tudor* (Jenks), b. July 18, 1830. 5. *Ames* (Jenks).
 6. *Alice Elizabeth* (Gray).
- 172 3. SAMUEL, b. Feb. 1801, d. Feb. 20, 1817, then of the Sophomore Class in Harv. Coll.
- 173 4. MARGARET, b. Nov. 29, 1802; m. Dr. EDWARD REYNOLDS, of Boston, grad. Harv. Coll. 1811; M.D. Br. Univ. and Bowd. Coll. 1825; Chirurg. Coll. R., et M.M.S., et A.A.S. He is a son of Edward and Deborah (Belcher) Reynolds, of Boston; gr. son of John and Dorothy (Weld) Reynolds, of Providence, R. I.; gr. grandson of Benjamin and Susanna (Rawson) Reynolds, of Bristol, R. I. This Susanna Rawson was eldest dr. of Rev. Grindall and Susanna (Wilson) Rawson, of Mendon, and gr. dr. of "Mr. Secretary" Edward Rawson. This Susanna Wilson was a dr. of Rev. John Wilson, of Medfield, and gr. dr. of Rev. John Wilson, first minister of Boston. Chil.,
 1. *John Phillips*, b. Nov. 20, 1825, grad. Harv. Coll. 1845; in 1853, studying medicine in Paris.
 2. *Adeline Margaret*, b. July 4, 1827, deceased.
 3. *Miriam Phillips*, b. May 6, 1829. 4. *Anne Foster*, b. May 2, 1831.
 5. *Margaret Elizabeth*, b. May 14, 1833. 6. *Adeline Ellen*, b. July 29, 1835.
 7. *Augusta Theresa*, b. Dec. 29, 1837.
- 174 5. MIRIAM, b. Nov. 20, 18—; m., June 8, 1831, Rev. GEORGE W. BLAGDEN, of Boston, b. Nov. 1802, grad. Yale Coll. 1823, D.D. Union Coll. 1843; pastor of Old South Church. Chil.,
 1. *Anna*, b. July 1832, d. 2. *John P.*, b. Aug. 6, 1833, d. young.
 3. *George*, b. Ap. 1835. 4. *Edward R.*, b. Feb. 1837. 5. *Thomas*, b. Oct. 1839.
 6. *Samuel P.*, b. Oct. 1841. 7. *Sally P.*, b. Aug. 1843.
 8. *Miriam P.*, b. Nov. 1845, d. 1849.
- 175 6. JOHN CHARLES, b. Nov. 15, 1807, grad. Harv. Coll. 1826; a clergyman in Methuen, Mass.; m., Dec. 24, 1833, HARRIET, dr. of Francis Welch, of Boston. Chil.,
 1. *Margaret W.*, b. July 12, 1835. 2. *John C.*, b. Oct. 1838.
 3. *Emily Susan*, b. June, 1842. 4. *Harriet W.*, b. May, 1845, d. young.
 5. *Miriam W.*, b. May, 1849. 6. *Anna Dunn*, b. Oct. 1850.
 7. *Caroline Crownshield*, b. July, 1852.
- 176 7. GEORGE WILLIAM, b. Jan. 3, 1810; grad. Harv. Coll. 1829; a counsellor-at-law, of Boston; m. (1st), June 1, 1836, EMILY BLAGDEN, b. in Washington, D. C., sister of Rev. G. W. Blagden. She d. Ap. 28, 1842, leaving *Emily B.*, b. Ap. 1, 1842. He m. (2d), June, 1845, MARY ANN BLAGDEN, sister of his first wife. She d. Ap. 22, 1848, s. p.
- 177 8. WENDELL, b. Nov. 29, 1811, grad. Harv. Coll. 1831; LL.B. 1834; a counsellor-at-law; now (1853), of Florence, Mass.; m., Oct. 1837, MARY ANN GREENE, dr. of Benjamin Greene, of Boston, s. p.
- 178 191 192 193 194 195 196 197 198 199 200 201

- 202 9. GRENVILLE TUDOR, b. Aug. 14, 1816, grad. Harv. Coll. 1836, counsellor-at-law, of Boston; in 1853, unm.
-
144. 203 (VI.) Col. JOHN PHILLIPS, of Andover, grad. Harv. Coll. 1795. After leaving college, he was for some time assistant in Phillips Academy; after that, read law with Hon. Samuel Dexter. He, however, relinquished the legal profession, and engaged in mercantile business in Charlestown, and thence removed to Andover, where he prosecuted the same business. He was public-spirited in projecting turnpikes, and in encouraging other public improvements of the day. He was a man of ardent and generous feelings, and, when Andover Theological Seminary was about to be founded, in 1807, he, with his noble-minded, pious, and benevolent mother, engaged to build a large edifice for the accommodation of students. He was commander of an independent company, an aid of Governor Strong, and a State Senator. Col. Phillips m., Dec. 22, 1798, LYDIA GORHAM, dr. of Hon. Nathaniel Gorham, of Charlestown. He d. Sept. 1820, aged 44, and his wid. is now, (1855,) living in Andover. Chil.,
-
- 204 1. PHEBE, b. Dec. 1, 1799; m., May 27, 1824, Rev. JONATHAN CLEMENT, of Chester, N. H.
- 205 2. SAMUEL, b. Mar. 8, 1801, grad. Harv. Coll. 1819; m., Oct. 23, 1827, SALLY SWETT, of Boxford.
- 206 3. REBECCA GORHAM, b. Aug. 19, 1802.
- 207 4. LYDIA, b. Ap. 12, 1804; m., Oct. 15, 1850, Dr. JOHN CALL DALTON, of Lowell, grad. Harv. Coll. 1814, M.D. 1818; M.M.S.S.
- 208 5. JOHN (twin), b. Ap. 12, 1804; m. (1st), Nov. 26, 1829, SARAH DORR, of Roxbury. He m. (2d), Mar. 22, 1851, CAROLINE LITTLE, of Newburyport.
- 209 6. ELIZABETH BARNARD, b. Dec. 17, 1805; m., June 30, 1839, WILLIAM STEVENS, of Andover.
- 210 7. SARAH WHITWORTH, b. Feb. 18, 1807.
- 211 8. MARY ANN, b. Mar. 17, 1808; m., Sept. 9, 1833, WILLIAM GRAY BROOKS, a merchant, of Boston, [Brooks, 173, p. 726.] Chil.,
- 212 1. William Gray, b. July 2, 1834. 2. Phillips, b. Dec. 13, 1835.
- 214 3. George, b. Dec. 18, 1838. 4. Frederick, b. Aug. 5, 1842.
- 216 5. Arthur, b. June 11, 1845. 6. John Cotton, b. Aug. 29, 1849.
- 218 9. SUSAN LOWELL, b. Mar. 5, 1809. 10. CAROLINE, b. Aug. 3, 1810.
- 220 11. JULIA, b. Feb. 9, 1813; m., July 26, 1842, ISAAC TOMPKINS, of Manchester.
- 221 12. AMELIA, b. Feb. 9, 1813. 13. NATHANIEL GORHAM, b. June 24, 1816.

PHILLIPS, APP. I.—WHITE.

- 1 (I.) WILLIAM WHITE, b. 1610; landed at Ipswich, 1635. Tradition says, that he came from Co. Norfolk, England; but this has not been ascertained. "In 1635, the year he landed, the General Court ordered the bounds of Ipswich and Quascacunquen (now Newbury), to be laid out, when some of the chief [people] of Ipswich, desired leave to remove to Quascacunquen, to begin a settlement which was granted them. Among those who moved to Newbury, were Rev. Thomas Parker, Nicholas Noyes, Henry Sewall, William White, William Moody, and Richard Kent." In 1640, William White removed to Haverhill, of which he was one of the first settlers, and was one of the grantees of the Indian deed, of Haverhill, dated Nov. 15, 1642; which instrument was, it is said, both written and witnessed by him. The Haverhill town records, show that he held a very respectable social position among the early settlers. His first wife, MARY, the mother of his only child, d. Sept. 22, 1681. He m. (2d), Sept. 21, 1682, wid. SARAH FOSTER. He d. Sept. 28, 1690, and his wid. d. in Ipswich, 1693. Chil.,
-
3. 2 1. JOHN, b. about 1639 or 40.
-
2. 3 (II.) JOHN WHITE, of Haverhill; m., in Salem, Nov. 25, 1662, HANNAH FRENCH. He d. in Haverhill, Jan. 1, 1668-9, aged 29 yrs., leaving an only child, John. His wid. m. Thomas Philbrick [See Philbrick, in Part II.] According to a provision in his Will, the care of his son devolved upon his father, Wm. White. Chil.,
-
5. 4 1. JOHN, b. Mar. 8, 1663-4.

4. 5 (III.) JOHN WHITE, Jr., Esq., of Haverhill; m., Oct. 24, 1687, LYDIA GILMAN, dr. of Hon. John Gilman, of Exeter, and a granddr. of Edward Gilman, who came from Norfolk, Eng., and settled first in Hingham, thence went to Ipswich; and he had become a resident of Exeter, previous to 1652. Chil,
1. JOHN, b. Sept. 11, 1688; d. Aug. 19, 1705.
 - 6 2. MARY, b. June 24, 1690; d. 1777; m., May 10, 1711, JAMES AYER, of Haverhill.
 - 7 3. HANNAH, b. 1691; m., Jan. 17, 1711-12, Rev. SAMUEL PHILLIPS, of Andover. [Phillips, 91.] She d. 1775.
 18. 8 4. WILLIAM, b. Jan. 18, 1693-4; m. SARAH PHILLIPS.
 26. 9 5. SAMUEL, b. Dec. 23, 1695; m. RUTH PHILLIPS.
 - 10 6. NICHOLAS, b. Dec. 4, 1698; d. in Plaistow, N. H., Sept., 1772.
 - 11 7. TIMOTHY, b. Nov. 13, 1700; grad. Harv. Coll., 1727; sometime a minister in Nantucket; d. in Haverhill, 1765.
 - 12 8. ELIZABETH, b. Nov. 16, 1702; m. Rev. AMOS MAIN, of Rochester, N. H.; grad. Harv. Coll., 1729; d. 1760.
 - 13 9. JAMES, b. Ap. 16, 1705; settled in Atkinson, N. H.; was a Colonel, and d. there May, 1788. Major Joseph Sprague, of Salem, m. his daughter. [See I. Stearns, 258, V.]
 - 14 10. JOHN, b. Sept. 8, 1707; d. in Haverhill, May 10, 1745.
 - 11 11. JOSEPH, b. Oct. 21, 1709; d. Ap. 4, 1713.
 - 15 12. ABIGAIL (twin), b. Oct. 21, 1709; m., Mar. 5, 1727-8, MOSES HAZEN. She d. in Haverhill, Dec., 1792. She was the mother of Gen. Moses Hazen, of the Revolutionary Army.
 - 17 13. LYDIA, b. Sept. 11, 1711; m. NATHANIEL PRASLEE, Esq.
 14. JOANNA, b. Mar. 31, d. Nov. 2, 1714.
-
8. 18 (IV.) Dea. WILLIAM WHITE; a Captain, and Justice of the Peace, of Haverhill; m., June 12, 1716, SARAH PHILLIPS, b. Jan. 28, 1691-2, dr. of Samuel and Mary (Emerson) Phillips, of Salem, a granddr. of Rev. Samuel Phillips, of Rowley, and a gr. granddr. of Rev. George Phillips, of Watertown. [Phillips, 40.] He d. Dec. 11, 1737. Chil,
- 19 1. WILLIAM, b. Ap. 12, 1717; a merchant, of Boston; m. REBECCA STODDARD, and d. 1773, s. p.
 47. 20 2. SAMUEL, b. Sept. 15, 1718; d. in Haverhill, Aug. 21, 1801.
 83. 21 3. JOHN, b. Feb. 7, 1719-20; d. at Metheven, in 1800.
 4. NATHANIEL, b. Nov. 24, 1721; d. young. 5. SARAH, b. 17, d. 19, Sept. 1723.
 109. 22 6. TIMOTHY, b. Sept. 23, 1724; d. Sept., 1791.
 - 23 7. MARY, b. Ap. 30, 1726; m. Rev. JOHN CHANDLER, of Billerica; grad. Harv. Coll., 1743; d. 1762, s. p. She was his first wife.
 - 24 8. SARAH, b. Mar. 9, 1727-8; m. ——— THOMPSON, of Billerica, s. p.
 112. 25 9. PHILLIPS, b. Oct. 28, 1729.
 10. EBENEZER, b. Aug. 2, d. Aug. 7, 1731.
 11. ANNA, b. Oct. 24, 1732; d. June 26, 1737.
-
9. 26 (V.) SAMUEL WHITE, a miller, of Haverhill; m., in 1718, RUTH PHILLIPS, a sister of his brother William's wife. [Phillips, 42.] Chil,
123. 26 1/2 1. JOHN, b. Dec. 26, 1725; grad. Harv. Coll., 1751.
 2. LYDIA, b. Aug. 1, 1728; d. Ap. 6, 1736.
 - 27 3. RUTH, b. Dec. 27, 1729; m., Nov. 16, 1758, CUTTING MARSH, of Haverhill. She d. Nov. 3, 1815, and he d. Jan. 14, 1818. Chil.,
 - 28 1. Ruth, b. Nov. 9, 1760. 2. Mary, b. Oct. 8, 1762.
 - 30 3. Samuel White, b. Mar. 9, 1765. 4. Joseph, b. May 14, 1767.
 - 32 5. Benjamin (twin), b. May 14, 1767. 6. Robert, b. July 16, 1769; d. of a casualty.
 - 33 7. John, b. Mar. 11, 1772.
 - 34 4. ELIZABETH, b. July 21, 1731; m., Jan. 18, 1759, Rev. JOHN CHANDLER, of Billerica, his 2d wife. [See above, No. 23.]
 - 34 1/2 1. Elizabeth, m. Thomas Plumer, of Haverhill.
 5. SAMUEL, b. Ap. 15, 1734; d. Ap. 10, 1736.

- 35 6. LYDIA, b. Nov. 2, 1786; m., Nov. 18, 1762, Capt. SOLOMON KIDDER, of Billerica.
 She d. May, 1778, and he d. at White Plains, in 1778. Chil.,
- 36 1. *Samuel*, d. at Manchester, N. H.
- 37 2. *Lydia*, b. about 1766, was living June, 1845; unm.
- 38 3. *Dolly*, d. in Manchester, N. H., unm.
- 39 7. MARY, b. Aug. 27, 1738; m. (1st) NATHANIEL BADGER, of Haverhill. 1 dr.
 He d., and she m. (2d) Rev. JOSEPH KIDDER, of Dunstable, brother of Capt.
 Solomon K. She d. in D., aged about 97. Chil.,
- 40 1. dr., m. Gen. *Abbot*, of Salem, s. p.
- 41 2. *Nathaniel* (Kidder), of Ohio; 1 son, and 4 daughters.
- 42 3. *Betsy* (Kidder), m. *Elijah Chamberlain*, sometime a trader, of Boston. In
 1845, she was living in Indiana, with her son Edwin.
- 43 4. *Sarah* (Kidder), m. *William Boynton*, of Dunstable. Chil.,
- 44 1. William. 2. Mary, both living in Indiana.
- 46 5. *Ruth* (Kidder), d. in Dunstable, unm.
-
20. 47 (V.) SAMUEL WHITE; of Haverhill, where he acquired a large estate; was
 Justice of the Peace, and Rep. to the Gen. Court, &c. He m. SARAH BROWN,
 dr. of Rev. Richard Brown, minister, of Reading (now South Reading), Mass.
 [Mr. Brown grad. Harv. Coll., 1697; was 11 years Grammar-schoolmaster, in
 Newbury; was ordained 1712, and d. 1732. His wid. m. — March, Esq., of
 Newbury, and her dr. Sarah, resided with her there, at the time of her marriage
 with Mr. White.] She d. Mar. 9, 1773. Chil.,
1. SARAH, b. Sept. 10, 1745; d. Dec. 22, 1746.
2. SARAH, b. Nov. 14, 1747; d. May 24, 1751.
- 48 3. MARY, b. May 20, 1750; m., Oct. 1, 1786, MOSES BROWN, a wealthy merchant,
 of Newburyport, and one of the associate founders of Andover Theol. Seminary.
 She d. Aug. 11, 1821, leaving one child, viz.,
- 49 1. *Mary*, b. July 25, 1787; m., Nov. 30, 1812, Hon. *William Bostwick Banister*,
 grad. Dart. Coll., 1797. She was his 2d wife, and d. Sept. 19, 1824. [He
 m. 3d Miss Zilpah Grant, for many years the eminent Principal of the
 Female Academy, in Ipswich.] He d. July 1, 1853. Chil.,
- 50 1. Mary Ann (Banister), b. Sept., 1816; d. Sept. 1, 1822.
2. Sarah White (B.), b. Jan. 28, 1819; m., June 13, 1844, Ebenezer
 Hale, M.D., Dart. Coll., 1829; d. Aug. 2, 1847, leaving wid. and son,
 Ebenezer, b. Oct. 8, 1845.
- 51 4. ANNA, b. Ap. 12, 1752; m., Oct. 21, 1780, Dr. NATHANIEL SALTONSTALL, of
 Haverhill. [Saltonstall, 122, in Part II.]
- 52 5. REBECCA, b. Aug. 10, 1754; m., Jan. 26, 1790, JAMES DUNCAN, Esq., a merchant,
 and magistrate, of Haverhill, and a Major of Cavalry. He d. Jan. 5, 1822, and
 she d. Nov. 4, 1838. Chil.,
- 53 1. *Samuel White*, b. Dec. 18, 1790; grad. Harv. Coll., 1810; of Haverhill; m.
Mary White, his cousin. [71.] He d. Oct. 21, 1824, s. p.
- 54 2. *James Henry*, b. Dec. 5, 1793; grad. Harv. Coll., 1812; a lawyer, of Haver-
 hill; State Senator, and Rep. in U. S. Congress; m., June 28, 1826. *Mary*
Willis, b. Dec. 15, 1805, dr. of Benjamin Willis, Jr., merchant, of Boston.
 [Son of Benjamin Willis, merchant, of Haverhill.] Chil.,
- 55 1. Rebecca White, b. Aug. 22, d. Sept. 22, 1827.
2. James Henry (twin), b. Aug. 22, 1827; grad. Brown Univ., 1848.
- 56 3. Benjamin Willis, b. Sept. 7, 1829; d. Oct. 22, 1830.
- 58 4. Rebecca White, b. Sept. 13, 1831. 5. Mary Willis, b. July 12, 1833.
- 58 6. George, b. Ap. 4, 1835; d. Feb. 17, 1840. 7. Susan R., b. Mar. 8, 1837.
- 59 8. Samuel White, b. Dec. 19, 1838. 9. Rosanna, b. Oct. 7, 1840.
- 61 10. Elizabeth, b. Dec. 25, 1842. 11. George Willis, b. Jan. 3, 1845.
- 63 12. Caroline, b. Oct. 12, 1846. 13. Margaret, b. Dec. 30, 1847.
- 65 6. SARAH, b. Ap. 9, 1757; m. DAVID HOWE, Esq., merchant, of Haverhill, his 2d
 wife. She d. Aug. 13, 1831, s. p.
- 66 7. SAMUEL, b. Aug. 26, 1759; a farmer, on the ancestral estate in Haverhill; m.,
 Mar. 22, 1789, LYDIA AYER, dr. of Nathaniel and Lydia Ayer, of Haverhill.
 She d. Feb. 8, 1802, and he d. Dec. 15, 1808. Chil.,
- 67 1. *William*, b. Sept. 4, 1789; a farmer, on the ancestral estate (being the 7th
 male descendant from the 1st William and Mary White); m., July 4, —,

- PRISCILLA DAVIS, dr. of James and Abigail (White) Davis. He d. Sept. 25, 1835. Chil.,
 1, and 2, a son and dr., d. in infancy.
 68 3. Samuel, b. Jan. 12, 1821. 4. James Davis, b. Mar. 31, 1824.
 70 5. William Henry, b. July 26, 1828.
 71 2. Mary, b. Jan. 10, 1792; m. Samuel W. Duncan, s. p. [See 58.]
 72 3. Sarah Brown, b. Sept. 29, 1793; m., Nov. 12, 1816, Joseph Henry Adams,
 merchant, of Boston, son of John Adams, of Andover. Chil.,
 73 1. Joseph Henry, b. Jan. 2, 1818; a civil engineer, and architect, of
 Washington, D. C.; m., Sept. 29, 1852, Addie M. De Leon, of Columbia,
 S. C. 1. Marion, b. July 29, 1853.
 74 2. Caroline Matilda, b. Ap. 4, 1819; m., Ap. 25, 1843, Charles Royal
 Bond, of Boston, merchant, son of the late George Bond, of Boston.
 [See Bond, 368.]
 1. Elizabeth. 2. Gertrude, d.
 75 3. Sarah Frances, b. Sept. 20, 1820; m., Ap. 30, 1845, William Johnson
 Dale; grad. Harv. Coll., 1837, M.D.; 1840, M.M.S.S.; of Boston.
 Chil., 1. Sarah Frances. 2. William J. 3. Edward Augustus Holyoke.
 76 4. Edward Franklin, b. Sept. 25, 1822; a broker, of Boston.
 77 5. John, b. Sept. 5, 1825; a merchant, of Chicago; m., May 5, 1852,
 Mary Hill, of Boston.
 78 6. Frederick Sheridan, b. Feb. 21, 1828; d. Nov. 15, 1847.
 79 7. Julia Maria, b. June 7, 1833.
 80 4. Fanny, b. Mar. 22, 1796; m. Warren Whittier, of Haverhill, and d. Oct. 27,
 1827, s. p.
 81 5. Lydia, b. Nov. 30, 1798.
 82 8. SUSANNA, b. Dec. 2, 1761; m., Dec. 7, 1779, JOHN WHITE [124.], her 2d cousin.
-
- 21.83 (V.) JOHN WHITE, of Haverhill, m. (1st wid. MIRIAM (Hoyt) HAZEN, of
 Haverhill. He m. (2d), Feb. 18, 1767, ELIZABETH HAYNES, b. Mar. 23,
 1746-7, dr. of Joseph Haynes, Esq., a trader and farmer, of Haverhill. He d. in
 Methuen, in 1800. Chil.,
-
- 177.84 1. WILLIAM, b. in Haverhill, Aug. 1, 1754; of Boston.
 186.85 2. MOSES, b. June 29, 1756.
 214.86 3. MIRIAM, b. Sept. 27, 1758; m. JOHN BODWELL, of Methuen.
 257.87 4. ELIZABETH, b. July 19, 1760; m. JACOB HALL, of Methuen.
 281.88 5. SARAH, b. Sept. 3, 1762; m. JAMES WILSON, of Worcester.
 6. LYDIA, b. 1764; d. in infancy.
 (By 2d wife, Elizabeth.)
 296.89 7. REBECCA, b. Nov. 10, 1768; m. DAVID MORSE.
 328.90 8. JOSEPH HAYNES, b. Dec. 20, 1770; was a physician.
 342.91 9. JOHN PHILLIPS, b. in Methuen, June 5, 1772; of Pelham, N. H.
 92 10. NATHANIEL HAZEN, b. in M., July 17, 1774; a merchant, of Rutland; m., in
 R., Nov. 17, 1803, CHARLOTTE HAZEN ATLEE, youngest dr. of the late Judge
 William Augustus Atlee, of Lancaster, Penn. He d. Dec. 25, 1804, leaving one
 child, viz.,
 1. Nathaniel Hazen, b. 1804; d. May 10, 1805, aged 9 m.
 376.93 11. DANIEL APPLETON, b. June 7, 1776; grad. Harv. Coll., 1797; of Salem.
 94 12. CHARLOTTE, b. Mar. 18, 1778, unm.
 13. POLLY, b. Mar. 6, d. May 3, 1780.
 399.95 14. TRUETHORTHY, b. Sept. 3, 1781; of Methuen.
 96 15. MARY, b. Oct. 29, 1784; m., Dec. 31, 1816, STEPHEN WEBSTER MARSTON, Esq.,
 a lawyer, of Newburyport, b. in Orford, N. H.; grad. Dart. Coll., 1811. She d.
 July 30, 1836. Chil.,
 97 1. George Phillips, b. Ap. 22, 1818; bred a merchant, in New York; is now
 (1853) engaged in mercantile and agricultural pursuits, at Atkinson, Wis-
 consin. He m., Oct., 1850, Harriet Marston, only dr. of Capt. Jeremiah
 Marston, of Orford, N. H. Chil.,
 1. George White, b. Oct. 22, 1851. 2. dr., b. Ap. 13, 1853.
 98 2. Stephen Webster, b. Oct. 11, 1819.
 99 3. William Augustus, b. May 22, 1821; educated at Dart. Coll., but did not
 graduate; was a lawyer, of Newburyport; d. Mar. 23, 1858, unm.

4. *Daniel White*, b. Feb. 15, d. Sept. 15, 1823.
 5. *Mary Wilder*, b. Dec. 6, 1824; d. Aug. 23, 1845.
 6. *Charles Story*, b. July 12, 1827; d. Sept. 30, 1845.
- 100 16. ANNA, b. July 28, 1786; m., Nov. 28, 1811, JONATHAN KIMBALL SMITH, b. Jan.
 25, 1774, son of Rev. Hezekiah Smith. One child, viz.,
 101 1. *Mary White*, b. Feb. 8, 1813; m., in Newton, Sept. 16, 1834, Rev. *Samuel*
Francis Smith, of Boston, b. Oct. 21, 1808; grad. Harv. Coll., 1829; Prof.
 of Waterville Coll.; now (1853) Pastor of the Baptist Church, at Newton
 Centre. Chil.,
 102 1. *Mary White*, b. in Waterville, Aug. 5, 1835.
 103 2. *Samuel Francis*, b. in W., Sept. 5, 1836.
 3. *Ann White*, b. and d. in W., Sept. 15, 1837.
 104 4. *Sarah Bryant*, b. in W., Oct. 18, 1838.
 105 5. *Daniel Appleton White*, b. June 18, 1840.
 6. *Elizabeth White*, b. July 23, 1841; d. Mar. 24, 1842.
 106 7. *Caroline Edwards*, b. in Newton, Aug. 19, 1843.
 8. *Charles Bradley*, b. 14, d. 17 June, 1845.
 107 9. *Ewing Underwood*, b. Mar. 2, 1849.
 108 17. GEORGE, b. Mar. 12, 1790, unm.
-
22. 109 (V.) TIMOTHY WHITE; some time a bookseller, of Boston, afterwards of
 Plaistow, N. H., where he d. Sept., 1791, aged 67. He m. ELIZABETH MONT-
 GOMERY, dr. of Capt. — Montgomery (who commanded a ship, sailing be-
 tween Boston and London). 2 chil.
- 110 1. TIMOTHY, b. 1768; left home at the age of 20 yrs., and was never heard of
 afterwards.
414. 111 2. JAMES, b. Feb. 21, 1774; of Boston, afterwards of Hampden, Me.
-
25. 112 (V.) Hon. PHILLIPS WHITE, was an officer in the army at Lake George, in
 1755. Upon his return, he engaged in mercantile pursuits in Newburyport, where
 he remained until 1765, when he moved to Southampton, N. H., where he
 spent the rest of his life, and d. Aug. 11, 1811, aged 82. He was a zealous
 patriot in the Revolution; was a member of the Provincial Congress of New
 Hampshire, held in Exeter, Dec., 1775, which Congress adopted, Jan. 7, 1776, the
 first State Constitution that was adopted in the country, and about 6 months
 before the signing of the Declaration of Independence. He was one of the com-
 mittee of safety; many years a member of the State Legislature, and Speaker of
 the House; was Judge of Probate, of Rockingham County, 1776 to 1790; mem-
 ber of the Convention, which met in Concord, N. H., June 10, 1778; Rep. in U. S.
 Congress, 1780. "His appearance is described as having a strong resemblance
 to that of Gen. Washington."
 He m. (1st), May 11, 1749, RUTH BROWN, of Newbury. She d. July 2,
 1797, and he m. (2d), June 16, 1798, SARAH, wid. of Dr. Dearborn, of North-
 ampton, N. H. She d. Aug. 2, 1808. Chil.,
- 113 1. JOHN, b. May 16, 1750; d. in Amesbury, 1775.
 114 2. WILLIAM, b. Jan. 12, 1752; d. in Southampton, N. H., July 1, 1806.
 115 3. PHILLIPS, b. Sept. 17, 1753; grad. Harv. Coll., 1772; and on his return from
 London, was lost overboard, Oct. 8, 1774.
 116 4. RUTH, b. July 8, 1755; d. Ap. 28, 1801; m. ROBERT LONG, of Newburyport.
 5. NATHANIEL, d. in infancy. 6. GILMAN, d. early.
 117 7. MOLLY, b. Jan. 20, 1759; d. 1827; m. STEPHEN GORHAM, of Boston.
 118 8. NATHANIEL, b. Mar. 8, 1761; resided many years in Portsmouth, N. H., and d.
 in Deerfield, N. H., Sept. 27, 1806.
 119 9. REBECCA, b. Dec. 15, 1762; d. Feb. 15, 1802; m. BENJAMIN BELL.
 120 10. GILMAN, b. Aug. 9, 1766; resided many years in Newburyport, but in 1844,
 was residing in New Bedford.
 121 11. THOMAS, b. Sept. 4, 1768; d. Aug. 22, 1792.
 12. LYDIA, b. June 10, 1770; d. Sept. 2, 1779.
 122 13. RICHARD, b. July 10, 1772; d. in Southampton, Oct. 12, 1814.
-
- 26½. 123 (V.) JOHN WHITE, grad. Harv. Coll. 1751; taught school some time in

Exeter, where he m. (1st) ELIZABETH GILMAN. She d. Nov. 2, 1757, and he m. (2d), Nov. 10, 1761, SARAH LE BARRON, who d. Feb. 17, 1802, aged 75. He was a merchant, of Haverhill, and a member of the Provincial Congress, in 1775. He d. Feb. 19, 1800. Chil.,

- 124 1. JOHN, b. in Exeter, June 28, 1752; of Haverhill; grad. Harv. Coll., 1771; m., Dec. 7, 1779, SUSANNA WHITE [82.], his 2d cousin. She d. Ap. 16, 1786, and he d. Jan. 6, 1816. Chil.,
- 125 1. Charles, b. Nov. 12, 1780; of Haverhill; formerly a merchant, a Colonel, Rep. to the Gen. Court, and a magistrate; now (1853) a wealthy bachelor, retired from business.
- 126 2. Susanna, b. Mar. 28, 1783; d. in 1836; m. Benjamin G. Boardman, formerly a merchant, of Newburyport, afterwards of Boston, where he now (1853) resides. 6 sons, 2 of whom d. in infancy.
3. John, b. and d. 1785.
- 127 2. SAMUEL GILMAN, b. June 2, 1754; m. DEBORAH GIDDINGS, of Exeter; lived some time in Haverhill, then moved to Goffstown, N. H.; where he d. July 20, 1799, and she d. in Concord, N. H., May 26, 1818. Chil.,
- 128 1. Henry, b. Mar. 29, 1778. 2. Elizabeth, b. May 11, 1780; d. Mar. 8, 1818.
- 129 3. Edward, b. Aug. 6, 1782; d. July 3, 1808. 4. Samuel G.,
- 130 5. Caroline G., d. Sept. 21, 1811.
- 131 6. Sarah, m. Judge Meacham, of Castleton, Vt., his 2d wife. [See 453.]
7. Mary.
3. NATHANIEL, b. Mar. 7, d. July 20, 1756.
4. ELIZABETH, b. May 15, d. July 14, 1757.
5. ELIZABETH, b. Mar. 11, d. Oct. 19, 1763.
430. 132 6. PEGGY, b. Mar. 2, 1766; m., Nov. 21, 1786, Hon. BAILEY BARTLETT, of Haverhill. He d. Sept. 9, 1830, and she d. Oct. 15, 1831.
- 133 7. LEONARD, b. May 3, 1767; grad. Harv. Coll., 1787; was a long time town-clerk of Haverhill; many years Cashier of the Merrimack Bank there, and was a member of Congress for Essex, north district. He was always much respected. He m. (1st), Aug. 21, 1794, MARY DALTON, dr. of Hon. Tristram Dalton, of Newburyport. [Mr. Dalton grad. Harv. Coll., 1755; was a Senator in Congress.] She d. June 18, 1839, aged 68, and he m. (2d), June 21, 1842, HANNAH CUMMINGS. He d. Oct. 10, 1849, aged 82. Chil.,
- 134 1. Mary, b. May 16, 1795; m. David Howe, Jr., of Haverhill, merchant, afterwards of N. York.
- 135 2. Leonard D., b. Dec. 9, 1796; m. Ann Bradley, of Andover. He d. July 11, 1824, leaving wid. and one daughter, viz.,
1. Ann, m. Albert Benson.
- 136 3. Sarah D., b. Nov. 15, 1798; d. Aug. 21, 1820.
4. Katherine, b. July 21, 1800; d. May 18, 1802.
- 137 5. George, b. Ap. 24, 1802; d. Sept. 17, 1826.
- 138 6. Frederick, b. Sept. 9, 1803; of New York, where he married.
- 139 7. Robert Hooper, b. Sept. 19, 1807; of New York.
- 140 8. Katherine, b. Mar. 31, 1809; d. Mar. 9, 1834.
- 141 9. Edward, b. Mar. 25, 1811; of New York.
- 142 10. John L., b. Feb. 19, 1814; of New York.
8. HENRIETTA, b. Aug. 21, d. Sept. 22, 1769.
-
84. 177 (VI.) WILLIAM WHITE, a merchant, of Boston; m., Oct. 26, 1775, his cousin, MARY CHANDLER, dr. of Rev. John Chandler, of Billerica. [See 23.] She d. in Boston, Feb. 21, 1794, and he d. Jan. 31, 1825. Chil.,
- 178 1. WILLIAM CHARLES, b. Ap. 17, 1777; a lawyer, of Worcester; "possessed of versatility of talents, which gave him some distinction as a player, poet, advocate, and author;" m., Oct. 23, 1805, TAMAR SMITH, dr. of James and Mary Smith, of Rutland. She d., and he m. (2d), in Sutton, Aug. 13, 1815, SUSANNA JOHANNOT, dr. of Dr. Stephen Munroe. He d. May 2, 1818. [See Hist. of Worcester, pp. 240, 44.] Chil.,
1. Harriet, d. aged 2 yrs. 2. Frederick, d. aged 20 yrs. 3. Julia, d. aged 9 m.
- 179 2. MOSES HAZEN, b. Nov. 8, 1778; d. June 5, 1829, highly respected; m., Feb. 9,

- 1808, ISABELLA FRINK, dr. of Dr. John Frink, of Rutland, Mass. She d. Nov. 9, 1810, leaving one child, and he lived afterwards a widower.
- 180 1. *Isabella Hazen*, b. Sept. 16, 1809; m., June 25, 1832, *Francis Dana, Jr.*; M.D., Harv. Univ., 1831, M.M.S.S.; of Boston (a gr. son of the late Chief Justice Dana, of Mass.) Chil.,
- 181 1. *Francis*, b. in Boston, Sept. 28, 1835; d. May 11, 1843.
2. *George Hazen*, b. Sept. 2, 1837.
- 182 3. *William Ellery*, b. Ap. 27, 1839; d. June 7, 1846.
4. *Isabella Hazen*, b. Feb. 9, 1847.
3. *CHARLES*, b. May 28, d. June 6, 1780.
4. *FREDERICK*, b. June 4, 1781, d. July 8, 1783.
5. *CHARLES LEONARD*, b. Feb. 25, 1783, d. Ap. 30, 1787.
- 183 6. *MARY CHANDLER*, b. June 9, 1785, d. Feb. 11, 1853, unm.
- 184 7. *JOHN CHANDLER* (twin), b. June 9, 1785; a merchant, in Mississippi, d. Oct. 6, 1846, unm.
- 185 8. *HARRIET*, b. Oct. 30, 1786, d. Sept. 30, 1850, unm.
9. *MARGARETTA*, b. July 2, d. Oct. 4, 1790.
-
85. 186 (VI.) Major *MOSES WHITE*, of Rutland; was several years a clerk in the store of Joseph Hazen, of Haverhill, the father of his mother's first husband. At the age of 20, he entered the army, and became the aid of Gen. Moses Hazen, and he served through the war with an untarnished character. He m., Dec. 7, 1786, *ELIZABETH AMELIA ATLEE*, eldest daughter of Judge William Augustus Atlee, of Lancaster, Penn. She d. June 12, 1808, aged 43. After her decease, he resided with his son, John Hazen, at Lancaster, N. H. He d. at the residence of his son-in-law, Rev. W. B. O. Peabody, D.D., of Springfield, Mass., May 28, 1833, aged 77. Chil.,
- 187 1. *WILLIAM AUGUSTUS*, b. Nov. 9, 1787. He, then sailing-master, was killed on board the frigate Chesapeake, in battle with the Shannon. "He had the reputation of a brave officer, and excellent general character."
- 188 2. *ESTHER AUGUSTA* (twin), b. Nov. 9, 1787; m. in Rutland, Feb. 17, 1811, *RUFUS PUTNAM*, Esq., a lawyer, of Rutland, grad. Will. Coll. 1804, son of Josiah and Sybil Putnam, of Warren, Mass. He d. Jan. 18, 1847, aged 64. Chil.,
- 189 1. *William Augustus*, b. June 1, 1812; m., Jan. 13, 1833, *Mary Ann*, dr. of William Clarke, of Princeton, Mass. She d. Oct. 13, 1835, leaving dr. *Maria Clarke*, b. May 10, 1834, d. Oct. 31, 1835.
- 190 2. *Emeline Augusta*, b. Mar. 22, 1814, d. Oct. 8, 1817.
- 191 3. *James Rufus*, b. Mar. 17, 1816.
4. *Elizabeth Amelia*, b. June 23, 1820; m., Jan. 1, 1850, *John F. Estabrook*, now (1853), of Brandon, Vt., son of John and Dolly Estabrook, of Rutland. Chil.,
1. *Esther Augusta*, b. in Fitchburg, Nov. 20, 1850.
2. *James Atlee*, b. in F., Oct. 16, 1852.
- 192 5. *George Atlee*, b. Jan. 11, 1823; m. Ap. 13, 1847, *Philenia E. Fletcher*, dr. of David W. and Sarah Fletcher, of Rutland. Chil.,
1. *Amelia Maria*, b. 1848. 2. *Mary Chandler*, b. Nov. 20, 1849.
3. *Sallie Augusta*, b. Oct. 5, 1851.
- 193 6. *Atlee White*, b. Feb. 2, 1826.
- 194 3. *HORACE STOCKTON*, b. Dec. 15, 1790; bred a merchant; d. June 17, 1812.
- 195 4. *JOHN HAZEN*, b. Nov. 19, 1792; of Lancaster, Mass.; m. in Rutland, Nov. 3, 1813, *ROXANA ROBINSON*, of Wat., Mass., b. July 16, 1792. Chil.,
- 196 1. *Harriet Stockton*, b. Aug. 27, 1815; m., Dec. 10, 1845, *Edward Woodruff*, a lawyer, Judge, &c., of Cincinnati.
1. *Edward*, b. Oct. 19, 1846. 2. *Harriet White*, b. Oct. 14, 1852.
- 197 2. *Moses Hazen*, b. Oct. 2, 1817; m., May 29, 1845, *Mary Miller Williams*, of Waterford, Vt. Chil.,
1. *Harriet Wilson*, b. June 23, 1846, d. Oct. 24, 1848.
2. *Moses Hazen*, b. Mar. 10, 1849. 3. *Mary Lizzie*, b. Dec. 21, 1851.
- 198 3. *Elizabeth Amelia*, b. Dec. 31, 1819; m., May 31, 1847, *Edwin Seegur*, M.D., of Northampton, now of Springfield, Mass. Chil.,
1. *Charles*, b. Ap. 17, 1851, d. Sept. 9, 1852.
2. *Edward White*, b. Nov. 30, 1852.

- 199 4. *Sarah Wilson*, b. Jan. 23, 1822; m., June 16, 1845, *David Hazen Mason*, Esq., a lawyer, of Boston, grad. Dart. Coll., 1841. Chil.,
 1. *Ellen White*, b. Mar. 22, d. Aug. 10, 1846.
 2. *Edward Haven*, b. June 8, 1849.
 3. *Elizabeth Amelia*, b. Ap. 7, 1853.
- 200 5. *William Atlee*, b. July 30, 1823, of Lancaster, N. H.; m., Sept. 2, 1846, *Ellen Caroline Woolcott*, of Charlestown, Vt., b. Oct. 25, 1825. Chil.,
 1. *Julia Robinson*, b. Jan. 8, 1848. 2. *William Augustus*, b. Jan. 25, 1850.
 3. *Isabella Atlee*, b. Sept. 5, 1851. 4. *Ellen Phillips*, b. Ap. 3, 1853.
- 301 6. *Ellen Augusta*, b. Aug. 15, 1826.
 7. *Francis Robinson*, b. May 7, 1828, d. Aug. 24, 1831.
 8. *Edward Livingston*, b. Nov. 18, 1831, d. Mar. 3, 1832.
- 202 9. *Horace Augustus*, b. Ap. 19, 1833.
- 203 10. *John Hazen*, b. Mar. 7, 1835.
- 204 5. **EDWIN ATLEE**, b. Mar. 9, 1794, grad. Dart. Coll. 1812. Soon became insane, and d. unm. He was a bright scholar, and of an amiable disposition.
- 205 6. **FRANCIS BOWES**, b. May 11, 1795. He entered Dart. Coll., but left, and entered the U. S. Naval Service, a Lieut. of Marines. He d. Sept. 25, 1819, leaving a good reputation.
- 206 7. **CHARLES LEONARD**, b. Mar. 10, 1797. He d. at Dalton, N. H., Feb. 1, 1835, leaving a widow and one child, who have since moved to the State of N. York.
- 207 8. **ELIZA AMELIA**, b. May 24, 1799; m. at Salem, Sept. 8, 1824, Rev. **WILLIAM BOURNE OLIVER PEABODY**, grad. Harv. Coll. 1816, D.D. 1842, son of Judge Oliver Peabody, of Exeter, N. H. He settled in Springfield, Mass., where she d., Oct. 3, 1843, and he d. May 28, 1847, eminent in literature, as well as theology. Chil.,
 1. *Fanny Bourne*, b. Sept. 2, 1825, d. Jan. 28, 1844.
 2. *Howard*, b. Aug. 3, 1827, d. May 12, 1828.
 3. *Everett*, b. June 13, 1830, grad. Harv. Coll. 1849, engineer.
- 208 4. *Francis Howard*, b. Oct. 9, 1831; a clerk, in Boston.
- 209 5. *William Bourne*, b. May 9, 1834; engineer.
- 210 6. *Oliver White* (twin), b. May 9, 1834; a clerk, in Boston.
- 211 9. **CHARLOTTE LA SWESSEE**, b. Oct. 23, 1801; d. Feb. 25, 1852, in Worcester, unm.
- 212 10. **MARY JANE**, b. Jan. 8, 1803; m. — **WILLIAMS**, a lawyer, of Woodstock, Conn.
-
86. 214 (VI.) **Hon. JOHN BODWELL**, of Methuen, b. in Methuen, Jan. 16, 1752; m. **MIRIAM WHITE**. He was Rep. in the Mass. Legislature; afterwards a Rep. and Senator in Maine Legislature. He moved from Methuen to Shapleigh, Me., where he d. Nov. 19, 1811, and his wid., **Miriam**, d. Dec. 21, 1825. Chil.,
- 215 1. **JOHN**, b. Oct. 14, 1776; of Shapleigh; m. **SALLY JAMES**, b. Dec. 9, 1779. He has been Rep. and Senator in Maine Legislature. Chil.,
- 216 1. *Elisha*, b. Dec. 6, 1797; m. *Polly Wood*, b. Aug. 1798. Chil.,
- 217 1. *John F.*, b. Dec. 15, 1823; m. *Sarah Jane Bragdon*, b. Feb. 25, 1823. Chil.,
 1. *Eliza F.*, b. Dec. 8, 1845, d. Oct. 8, 1847. 2. *Sarah*, b. June 1, 1850.
- 218 2. *Enoch W.*, b. Jan. 9, 1827; m. *Sarah J. Garvin*, b. Nov. 12, 1827.
 3. *Sarah*, b. July 12, 1829, d. 1849.
 4. *Phebe H.*, b. Ap. 18, 1831, d. Ap. 23, 1847.
- 219 2. *John White*, b. Sept. 2, 1800; m. *Julia Ann Allen*, b. Sept. 26, 1806. Chil.,
 1. *Elisha Allen*, b. Jan. 10, 1826, d. May 12, 1827.
 2. *Elisha Allen*, b. May 2, 1829; m. *Grace Elizabeth Robinson*.
- 220 3. *William Henry*, b. Dec. 31, 1834.
- 221 4. *Henry William* (twin), b. Dec. 31, 1834.
- 222 3. *Asa*, b. Jan. 3, 1804; m. *Temperance Hilton*, b. Sept. 26, 1809, s. p.
- 223 4. *Ursula*, b. Mar. 11, 1806.
- 224 5. *Miriam White*, b. Sept. 13, 1809; m. *Increase Sumner Kimball*, b. Aug. 7, 1803. Chil.,
 1. *John Bodwell*, b. Mar. 24, 1832, d.
 2. *Sumner Increase*, b. Sept. 2, 1834.
 3. *Miriam White*, b. June 13, 1836.
 4. *Maria H.* (twin), b. June 3, d. Dec. 18, 1836.
 5. *Helen Maria*, b. Aug. 30, 1839.

6. Mary Emily, b. Aug. 11, 1842.
 7. John Bodwell, b. Aug. 24, 1843.
 8. Sarah Bodwell, b. Sept. 7, 1845.
 9. Elizabeth Francis Appleton, b. Oct. 29, 1847.
- 226 6. *Araspes*, b. Feb. 4, 1812; m. *Maria Jenkins*. Chil.,
 1. Sarah Bodwell, b. Ap. 5, 1842.
 2. Joan, b. Ap. 8, 1843.
- 227 7. *Horace*, b. Oct. 4, 1816; a Brig.-General in the militia; m. *Eliza Brackett*,
 b. Sept. 17, 1817. Chil.,
 1. John Brackett, b. Oct. 5, 1838. 2. Mary Elizabeth, b. Ap. 5, 1840.
 3. Miriam Brackett, b. Feb. 9, 1842.
 4. Phebe Miranda, b. Dec. 23, 1843.
 5. Julia Merinda, b. Dec. 3, 1845.
 6. Horace Jefferson Dallas, b. Mar. 7, 1848.
- 228 8. *Sally Belinda*, b. Mar. 11, 1819; m. *Lewis Wentworth*, b. in Somersworth,
 Aug. 27, 1817, s. p.
- 229 9. *Mary Ann*, b. June 14, 1821; m. *David Grant*, b. Feb. 13, 1819. Chil.,
 1. John Bodwell, b. Feb. 8, 1845, d. Jan. 23, 1847.
 2. John Bodwell, b. June 22, 1849.
- 230 10. *John E.*, b. Feb. 19, 1824; m. *Louisa Jane Goodwin*, b. Jan. 26, 1829. Chil.,
 1. William Albion, b. June 28, 1847.
 2. Amos Dinsmore, b. Sept. 24, 1848.
 3. Increase Sumner Kimball, b. Feb. 8, 1850.
- 231 2. *MIRIAM*, b. June 4, 1778, d. May 16, 1848; m. *DANIEL WOOD*, b. Feb. 5, 1767,
 d. July 29, 1846. He was member of the Executive Council of Maine five
 years, and held various other offices. Chil.,
- 232 1. *Miriam Bodwell*, b. May 6, 1796; m. *Tristram Fall Goodwin*, b. Nov. 23,
 1802, s. p.
- 233 2. *Mary Plummer*, b. Jan. 11, 1798; m. *William Lowell Foote*, b. July 26, 1791.
 Chil.,
- 234 1. Mary Elizabeth, b. Jan. 11, 1826.
- 235 2. William Lowell, b. Sept. 13, 1827; m. *Eliza Meserve*, b. July 8, 1825;
 dr. *Julia Ann*, b. Oct. 22, 1848.
- 236 3. Daniel Wood, b. Dec. 8, 1829.
- 237 4. Judith Hannah, b. Ap. 13, 1832.
- 238 5. Margaret Pollard, b. June 13, 1834.
- 239 6. Sarah Lowell, b. Feb. 8, 1837.
- 240 7. John Bodwell, b. June 5, 1840.
- 241 8. Susan Amelia, b. Oct. 6, 1843.
3. *Daniel*, b. May 25, 1800, d. Oct. 14, 1803.
- 242 4. *John Bodwell*, b. Feb. 8, 1802; m. *Arabella S. Goodwin*, b. Nov. 14, 1809.
 Chil.,
- 243 1. John Bodwell, b. Dec. 7, 1827; m. *Abby Jane Gerrish*, b. Sept. 9,
 1828.
- 244 2. Fernando Gorges, b. Ap. 28, 1829.
 3. Alonzo, b. June 8, 1831, d. June 29, 1849.
 4. Daniel, b. Feb. 3, d. Oct. 3, 1838.
 5. Mary Sophia, b. Sept. 3, 1842.
- 245 5. *Caroline Matilda*, b. July 19, 1805; m. *James Edwards*, and she d. Jan. 20,
 1826, leaving son Daniel Wood, b. Oct. 11, 1825.
- 248 6. *Daniel*, b. June 30, 1807; m. *Mary Pray*, s. p. He was aid to Gen.
 Hodson in the Aroostook war.
- 249 7. *Charlotte Maria*, b. Aug. 31, 1809; m. *Temple Wood*, b. Feb. 7, 1796. Chil.,
- 250 1. Edwin White, b. Ap. 26, 1838.
- 251 8. *Frederick Ansel*, b. Mar. 12, 1811; m. *Mary Libbey*, b. Mar. 17, 1813. He
 has been Rep. and Senator in the State Legislature. Chil.,
- 252 1. Caroline Maria, b. Aug. 15, 1832.
- 253 2. Miriam Bodwell, b. Oct. 24, 1834.
- 254 3. Frederick Ansel, b. Mar. 20, 1839.
- 255 4. Mary Plummer, b. July 15, 1849.
- 256 9. *Catherine Margaret*, b. Oct. 5, 1813.
 10. *Edwin White*, b. June 12, d. Dec. 28, 1815.
 11. *Julia Ann*, b. Nov. 15, 1817, d. Ap. 27, 1818.

87. 257 (VI.) JACOB HALL, a goldsmith, of Methuen; m., in Methuen, Dec., 1781, ELIZABETH WHITE. Chil., all b. in M.
- 258 1. ABIGAIL, b. Dec. 8, 1782; m., in 1832, NEHEMIAH HERRICK, of Methuen, s. p.
- 259 2. MOSES, b. Ap. 17, 1784; a cordwainer, of Andover; unm.
3. ELIZABETH, d. aged one year.
- 260 4. ELIZABETH, b. Jan. 7, 1788; m., in 1809, JEREMIAH FRYE, of Methuen. Chil.,
1. Francis Frye, b. July, 1810.
- 261 2. Jeremiah, b. 1812; m. Harriet Bodwell, of Methuen.
- 262 3. Elizabeth, b. 1814; m. Elam Dole, of Methuen.
- 263 4. Catherine Frye, b. 1816; m. Leverett Bradley, of Haverhill.
- 264 5. Ashley, b. 1818. 6. Sarah, b. 1820.
- 265 5. MIRIAM, b. Feb. 16, 1790; m., May 1, 1811, NATHANIEL HASTINGS. She m. (2d),
- Ap. 28, 1842, Jacob How, of Haverhill.
- 267 1. Albert Hastings, b. Feb. 23, 1812; m. Harriet Smith. 2 chil.
- 268 2. Nathaniel, b. Nov. 12, 1814; m. Evetine Emery. 2 chil.,
- 269 6. JACOB, b. Ap. 10, 1792; m. MARY FRENCH, of Nashua. Chil.,
- 270 1. John. 2. Eliza. 3. Luke.
- 273 7. JOHN, b. Feb. 14, 1795; d. Sept. 21, 1829, unm.
- 274 8. WILLIAM WHITE, b. Ap. 28, 1797; grad. Brown Univ., 1825; a Baptist minister; settled first in Marshfield, and afterwards in Edgartown, Mass.; m. SARAH ALLEN BUNTING, wid. of James Bunting, of Edgartown. Chil.,
- 275 1. John Leroy, b. Feb. 7, 1842.
- 276 9. MARY C., b. July 10, 1799; m., 1829, JOSEPH WHITTIER, of Haverhill. 2 chil. She m. (2d), JONATHAN PETTINGILL, of Salem, N. H., s. p. Chil.,
- 277 1. Hazen Whittier, b. 1830. 2. Jane, b. 1833.
- 279 10. NATHANIEL HAZEN, b. June 25, 1802; d. Mar. 26, 1828, unm.
- 280 11. CHARLOTTE, b. Nov. 29, 1804; m., in July, 1833, Rev. JARED PERKINS, a Methodist Episcopal clergyman, and recently, a member of Congress, from the State of N. Hampshire. Chil.,
1. Jared. 2. Caroline. 3. Henry. 4. Charlotte.
-
88. 281 (VI.) JAMES WILSON, b. in Durham, Eng., July 11, 1763; a merchant, and for a long time Postmaster of Worcester, Mass.; m., Sept. 26, 1795, SARAH WHITE. He d. Feb. 5, 1841, aged 77, and she d. Mar. 11, 1841, aged 78, both at Cincinnati. Chil. all b. in Worcester.
- 282 1. JOHN MILBURN, b. Jan. 9, 1797; a merchant; d. at West Baton Rouge, Louisiana, Sept. 24, 1829, unm.
- 283 2. JAMES, b. Aug. 10, 1798; a merchant; m., in Cincinnati, Ap. 21, 1823, ELIZA BOGIE, b. in Scotland, Ap. 28, 1805. First three chil. b. and d. in Pinkneyville, Wilkinson Co., Mississippi; the others in Cincinnati, viz.:
1. James, b. July 27, 1824; d. Sept. 23, 1827.
2. John Milburn, b. Sept. 1, 1826; d. Mar. 20, 1828.
3. Eliza Amelia, b. Sept. 30, 1828; d. July 27, 1829.
- 284 4. Sarah, b. June 2, 1830.
5. Frances, b. Sept. 27, 1832; d. June 9, 1836.
6. John Milburn, b. Feb. 17, 1835. 7. James Bogie, b. Mar. 2, 1838.
- 285 8. Frank White, b. May 20, 1840. 9. Eliza Bella, b. Ap. 22, 1844.
- 287 3. SARAH WHITE, b. May 1, 1800; m., Ap. 30, 1838, RENSSELAER W. LEE, merchant, of Cincinnati. Chil.,
- 288 1. Rensselaer Wilson, b. Ap. 5, 1839.
- 289 2. Sarah Frances, b. about 1842.
- 290
- 291 4. FRANCES, b. Ap. 24, 1802; m., Nov. 11, 1834, Rev. ROBERT EVERETT PATTISON, grad. Amh. Coll., 1826; D.D. Waterville Coll., 1838; pastor of a Baptist Church in Salem, Mass., afterwards in Providence, R. I.; Prof. and President of Waterville Coll.; President of the Theol. Acad., Covington; now (1853) Prof. in Newton Theol. Seminary. Chil.,
1. Everett, b. Ap. 14, d. May 15, 1836.
2. Frances, b. Sept. 10, 1837. 3. Everett Wilson, b. Feb. 22, 1839.
4. Juliet, b. Ap. 14, 1842. 5. James William, b. July 14, 1844.
-
89. 296 (VI.) DAVID MORSE, a farmer, of Haverhill; m., in Methuen, Ap. 12, 1797, REBECCA WHITE. Chil.,

- 297 1. REBECCA, b. Feb. 7, 1798; d. June, 1824, unm.
- 298 2. AMELIA ATLEE, b. Dec. 11, 1799; m., Nov. 9, 1831, Rev. EDMUND WORTH, b. Oct. 12, 1809; a Baptist minister, of Concord, N. H. Chil.,
- 299 1. *Amelia Atlee*, b. Mar. 21, 1833. 2. *Edmund*, b. Ap. 20, 1836.
3. *Harriet*, b. Ap. 12, 1839. 4. A dr., b. and d. Sept., 1841.
5. *Mary Ann Rebecca*, b. Aug. 14, 1843; d. Ap. 2, 1850.
- 300 3. JOHN HENRY, b. Oct. 23, 1801; m., June 16, 1834, CATHERINE PEARSON MORSE, dr. of Joseph Morse. Chil.,
- 301 1. *Susan Pearson*, b. Mar. 21, 1835.
- 302 2. *John Hiram*, b. Mar. 8, 1838.
- 303 4. RACHEL H., b. Jan. 2, 1804; d. Jan. 25, 1841; m., Dec. 25, 1829, RUFUS K. KNOWLES, of Haverhill. Chil.,
- 304 1. *Rebecca Morse*, b. Sept. 20, 1829; m., Ap. 27, 1851, *James Bradley*, of Haverhill.
2. *Rufus Allen*, b. Aug. 9, 1831; d. Nov. 2, 1848.
- 305 3. *John Henry*, b. Mar. 13, 1833. 4. *Charles King*, b. Jan. 2, 1835.
- 307 5. *Horace Morse*, b. Dec. 7, 1836.
6. *Oliver Morse*, b. June 8, 1839; d. Jan. 10, 1841.
- 308 5. HORACE TRUEWORTHY, b. July 22, 1806; of Haverhill; m. LOUISA WHITE. In Oct., 1852, he moved with all his family, except David, to Farmington, Iowa. Chil.,
- 309 1. *Horace*, b. June 5, 1830. 2. *David*, b. Oct. 25, 1831.
- 311 3. *Rebecca White*, b. May 29, 1833; m., Nov. 27, 1851, *George Washington Ladd*, son of Major John Ladd, of Haverhill.
- 312 4. *Moses Hazen*, b. Ap. 22, 1837. 5. *Geo. Washington*, b. Sept. 7, 1839.
6. *Harriet Kildreth*, b. May 4, 1841; d. Oct. 6, 1842.
- 314 7. *Mary White Smith*, b. Ap. 17, 1844. 8. *Elizabeth Ann*, b. Jan. 20, 1846.
- 316 9. *Samuel Francis Smith*, b. Aug. 21, 1849.
- 317 6. MARY ANN, b. Jan. 11, 1810; m., July 5, 1830, Dea. WILLIAM BAILEY, b. in Newburyport, Feb. 15, 1794, son of Wm. Bailey. They settled in Clinton, Wayne Co., Penn., where his children were all born. He d. Ap. 19, 1853. Chil.,
- 318 1. *Moses White*, b. Mar. 23, 1831; d. Nov. 23, 1839.
2. *Ruth Johnson*, b. June 17, 1832; m., May 29, 1849, *William W. Porter*, of Soranton, Penn. She d. Nov. 4, 1852, leaving son Edmund Worth, b. Mar. 1852.
- 319 3. *Mehitabel Ann*, b. Feb. 16, 1834. 4. *John Marshman*, b. Jan. 28, 1836.
- 321 5. *Harriet Hildreth*, b. Nov. 11, 1837. 6. *Edgar Smith*, b. Nov. 3, 1839.
- 323 7. *Mary Jennette*, b. Nov. 8, 1841. 8. *Sylvester North*, b. Nov. 11, 1843.
- 325 9. *Nathaniel*, b. Ap. 2, 1846. 10. *Charles Wood*, b. Oct. 3, 1849.
- 327 7. HARRIET HILDRETH, b. Oct. 13, 1813, unm.; now (1853) a Baptist Missionary teacher, at Bankok, Siam.
-
90. 328 (VI.) JOSEPH HAYNES WHITE, studied medicine with Dr. Kittridge, of Andover, and resided successively in Gloucester, Methuen, and Marblehead. He m. MARY BOND, b. Jan. 5, 1775, dr. of Dr. John and Mary (Moulton) White, of Newburyport. She d. in Marblehead, Feb., 1807.
-
1. CAROLINE LITCHFIELD, b. Dec. 31, 1793; d. 1814.
2. JOSEPH HAINES, b. Aug., 1795; d. 1808.
- 329 3. MARY BOND, b. in Gloucester, Ap. 20, 1798; m., Dec. 6, 1818, Capt. WILLIAM REMICK, a shipmaster, of Newburyport. He d. Sept. 18, 1835. Chil.,
- 330 1. *Joseph Noyes*, b. Oct. 24, 1819; in mercantile business in Boston, unm.
- 331 3. *George White*, b. Feb. 28, 1820; m., Oct. 15, 1844, *Sarah C. Ordway*, of W. Newbury. Chil.,
- 332 1. *Mary White*, b. June 3, 1844. 2. *George Willis*, b. Jan. 3, 1849.
- 334 3. *George Mortimer*, b. Mar. 23, 1850.
3. *Juliann*, b. Oct. 14, 1823; d. May 8, 1844.
4. *Mary Elizabeth*, b. July 8, 1829; d. Jan. 3, 1838.
- 335 5. *Caroline White*, b. July 11, 1832.
- 336 4. ELIZA, b. in Methuen, July 24, 1800; m., Dec. 31, 1819, ELIPHALET CURRIER, a goldsmith, of Haverhill. He d. in 1831, and his wid. m. (2d), Sept. 29, 1839, MOSES MERRILL, Esq., a merchant, of Methuen, s. p. Chil.,
- 337 1. *Elizabeth White* (Currier), b. Oct. 18, 1822.

2. *Eustace Carey* (Currier), b. July 21, 1825; d. Oct. 6, 1828.
 3. *Ann Smith* (Currier), b. Oct. 28, 1828; d. June 6, 1843.
- 338 5. SALTONSTALL, b. Mar., 1803; of Oxford, Butler Co., O., unm.
- 339 6. NATHANIEL HAZEN, b. in Marblehead, May 24, 1805; a printer; m., Nov. 20, 1844, MARY SMITH, dr. of Rev. Eli Smith, of Frankfort, Ky. Chil.,
- 340 1. *Edward Joseph*, b. Oct. 29, 1845.
- 341 2. *Henry Kirke*, b. Oct. 25, 1847; d. June 18, 1849.
 3. *Mary Jane*, b. Nov. 7, 1849.
-
91. 342 (VI.) JOHN PHILLIPS WHITE, m., Ap. 12, 1797, LUCY GUTTERSON, of Pelham, N. H., where he settled. Chil.,
- 343 1. LUCY, b. Mar. 27, 1798; m., in 1822, NATHAN BODWELL, of Methuen, who d. Nov. 20, 1840. Chil.,
- 344 1. *John White*, b. Feb. 29, 1824; m., Dec. 28, 1848, *Harriet Lovejoy*.
- 345 2. *Nathan Robinson*, b. Sept. 18, 1828.
- 346 3. *Josiah White*, b. Nov. 30, 1832. 4. *Christopher Augustus*, b. Jan. 22, 1836.
- 348 5. *William Justus* (twin), b. Jan. 22, 1836.
 6. *Lucy Maria*, b. Feb., d. Jan., 1840.
- 349 2. JOSIAH GUTTERSON, b. Jan. 18, 1800; m., in Methuen, in 1826, PHEBE GAGE, of Methuen, where he settled. Chil.,
- 350 1. *John Gage*, b. Jan. 14, 1827.
- 351 2. *Henry Wilder*, b. June 13, 1829, d. Mar. 10, 1830.
 3. *Ellen Augusta*, b. Jan. 6, 1831; m., June 16, 1853, *George A. Mansfield*, of Boston.
- 352 4. *Clarimond Elizabeth*, b. Jan. 8, 1834, d. Oct. 18, 1851.
- 352 3. ELIZABETH, b. Mar. 12, 1802; m., in 1825, WILLIAM SWAN, of Methuen. She d. July 20, 1848. Chil.,
- 353 1. *Eliza Dinsmore*, b. Ap. 21, 1828. 2. *Harrison White*, b. June 21, 1830.
- 355 3. *Lucy Jennette*, b. Sept. 16, 1832. 4. *William Francis*, b. Sept. 5, 1835.
- 357 4. MARY ORNE, b. June 8, 1804; m., in 1833, MOSES MERRILL, of Methuen. She d. Jan. 17, 1839. One child.
- 358 1. *Calvin Addison*, b. June 15, d. Dec. 2, 1838.
- 358 5. MIRA, b. Nov. 14, 1806; m., in 1832, FREDERICK GEORGE, of Haverhill, and settled in Methuen. Chil.,
- 359 1. *Elmira*, b. June 26, 1835. 2. *Le Baron*, b. Sept. 25, 1837.
- 361 3. *Ogden*, b. May 4, 1840. 4. *Caroline Elizabeth*, b. Nov. 1, 1842.
 5. *Mary Orne White*, b. Oct. 9, 1846, d. Jan. 12, 1847.
- 363 6. SAMUEL, b. Jan. 28, 1809; m., in 1835, MEHITABEL ROBY, of Sutton, N. H., and settled in Pelham, N. H. She d. in Nov. 1851. Chil.,
- 364 1. *Mary Elizabeth*, b. Jan. 9, 1836.
- 365 2. *Sarah Ann*, b. Dec. 3, 1840.
- 366 7. NANCY SMITH, b. Feb. 9, 1811; m., in 1846, JOHN ADDEN, Jr., of Reading, Mass., s. p.
- 367 8. ADELINE CUTTER, b. July 24, 1815; m., in 1836, JOSHUA R. BOWERS, of Merrimack. Chil.,
- 368 1. *Oscar Dunreath*, b. Sept. 28, 1837, d. Sept. 19, 1848.
- 370 2. *Harrison Gray Otis*, b. Nov. 8, 1839. 3. *George Francis*, b. Nov. 26, 1841.
 4. *Frank Edgerty*, b. Nov. 10, 1843.
 5. *Sophronia Lucinda*, b. Oct. 4, 1845, d. Ap. 26, 1849.
 6. *Grace White*, b. Aug. 12, 1847. 7. *Edgar Stanley*, b. Nov. 16, 1849.
- 371 9. SARAH WILSON, b. Mar. 23, 1819; m., in 1835, WILLIAM EAYRS, of Merrimack, N. H. Chil.,
- 374 1. *Otis White*, b. in Nashua, Mar. 1836, d. Oct. 30, 1837.
 2. *Onslow Scott*, b. in N., Sept. 30, 1838, d. Feb. 27, 1840.
- 374 3. *Winslow Phillips*, b. in N., Aug. 31, 1840.
 4. *Mariette Foster*, b. in Concord, N. H., Oct. 28, 1843, d. Sept. 29, 1849.
- 375 5. *De Witt Clinton*, b. in C., Dec. 28, 1846.
-
93. 376 (VI.) Hon. DANIEL APPLETON WHITE, of Salem, grad. Harv. Coll. 1797; tutor 1799–1803; LL.D. 1837; S.H., et A.A.S. He m. (1st), May 24, 1807, at the house of her father-in-law, Dr. Isaac Hurd, Mrs MARY VAN SCHALKWYCK, dr. of the late Dr. Josiah Wilder, of Lancaster, Mass. (a grad. of Yale Coll. 1767).

- She d. June 29, 1811, and he m. (2d), in Salem, Aug. 1, 1819, Mrs. ELIZA WET-MORE, dr. of William Orne, Esq., late of Salem, merchant. She d. Mar. 27, 1821, and he m. (3d), in Charlestown, Jan. 22, 1824, Mrs. RUTH ROGERS, dr. of Joseph Hurd, Esq., late of Charlestown, merchant. Chil.,
-
1. MARY ELIZABETH, b. Mar. 27, d. Oct. 8, 1808.
- 377 2. ELIZABETH AMELIA, b. May 4, 1809; m. in Salem, Sept. 16, 1830, WILLIAM DWIGHT, a lawyer, of Springfield, grad. Harv. Coll. 1825, son of Hon. Jonathan Dwight (grad. Harv. Coll. 1793), of Springfield, Mass. Chil.,
- 378 1. *William*, b. July 14, 1831, educated at West Point.
- 379 2. *Wilder*, b. Ap. 23, 1833; grad Harv. Coll. 1853.
- 380 3. *Daniel Appleton*, b. Jan. 30, 1836.
- 381 4. *Howard*, b. Oct. 29, 1837. 5. *Thomas*, b. Oct. 5, 1840, d. Sept. 1, 1841.
- 382 6. *Charles Troubridge*, b. May 5, 1842. 7. *Chapman*, b. Ap. 30, 1844.
- 384 3. MARY WILDER, b. Dec. 12, 1810; m., in Salem, Oct. 21, 1835, CALEB FOOTZ, Esq., editor of the Salem Gazette. He has been member of Mass. Legislature, and of the Executive Council. Chil.,
- 385 1. *Eliza Dwight*, b. July 20, 1836, d. Sept. 3, 1837.
2. *Henry Wilder*, b. June 2, 1838.
3. *William Orne White*, b. Mar. 31, 1841, d. Sept. 29, 1842.
4. *Martha West*, b. Mar. 20, d. May 15, 1842.
- 386 5. *Mary Wilder*, b. Aug. 20, 1843. 6. *Arthur William*, b. Mar. 5, 1853.
(By 2d wife.)
- 388 4. WILLIAM ORNE, b. Feb. 12, 1821, grad. Harv. Coll. 1840; at the Theological School, Camb., 1845; was ordained in West Newton, Mass., Nov. 22, 1848, and installed Oct. 1, 1851, in Keene, N. H., where he now resides. He m., in Springfield, Mass., Sept. 25, 1848, MARGARET ELIZABETH HARDING, dr. of Chester Harding, artist, then of Springfield, now of Boston, s. p.
(By 3d wife.)
- 389 5. HENRY ORNE, b. Dec. 6, 1824; grad. Harv. Coll. 1848; M.D. Univ. Penn.; M.M.S.S., unmd.
6. FRANCIS HIGGINSON, b. Aug. 29, 1826, d. Ap. 8, 1827.
7. CHARLES HAZEN, b. Oct. 22, 1827, d. next day.
-
95. 390 (VI.) TRUEWORTHY WHITE, of Methuen; m., in 1802, FANNY BODWELL, dr. of Park and Sarah Bodwell. Chil.,
- 391 1. STEPHEN FAIRFIELD, b. Jan. 21, 1803; m., Nov. 22, 1832, REBECCA STEVENS, dr. of David K. and Sally W. Stevens. Chil.,
- 392 1. *Sarah Stevens*, b. in Lowell, Dec. 16, 1833.
- 393 2. *Mary Jane*, b. in L., Ap. 19, 1835. 3. *Eliza Dean*, b. in L., Jan. 25, 1837.
- 395 4. *John Appleton*, b. in Methuen, May 5, 1840.
- 396 5. *Hattie Augusta*, b. in M., Oct. 2, 1845. 6. *Anna Maria*, b. in M., Feb. 19, 1847.
- 398 2. REBECCA, b. Nov. 14, 1804; m., Dec. 1, 1831, GEORGE PERKINS, of Newburyport.
- 399 1. *George*, b. Aug. 6, 1832. 2. *Rebecca White*, b. Dec. 21, 1835.
- 401 3. *Daniel Appleton White*, b. Nov. 12, 1837.
- 402 4. *Stephen Marston*, b. Dec. 3, 1839, d. Nov. 28, 1840.
- 402 5. *Elizabeth White*, b. Aug. 17, 1841. 6. *Fanny White*, b. Nov. 24, 1843.
- 404 7. *Charles Bodwell*, b. Oct. 12, 1845.
3. FANNY, b. Nov. 17, 1806, d. Ap. 1807.
- 405 4. TRUEWORTHY, b. May 11, 1808; of Methuen; m. (1st), Sept. 5, 1831, SARAH ANN MANSUR, dr. of John and Martha M., of Salem, N. H. She d. July 5, 1840, and he m. (2d), Sept. 7, 1845, LISSETTE HUTCHINSON, dr. of Royal and Abigail H., of Milford, N. H. Chil.,
- 406 1. *Sarah Ann*, b. Feb. 13, 1833. 2. *Juliette*, b. Jan. 2, 1835.
- 408 5. FANNY, b. June 1, 1810. 6. JOHN, b. May 30, 1812, d. Oct. 28, 1838.
- 410 7. DANIEL APPLETON, b. Ap. 15, 1815; of Lawrence, Mass.; m., Oct. 21, 1851, CYNTHIA A. JONES, of New York.
1. *Ella Appleton*, b. Mar. 17, 1853.
- 411 8. CHARLES BODWELL, b. Sept. 6, 1816.
- 412 9. ELIZA, b. Ap. 1, 1821; m., Nov. 8, 1847, NATHANIEL R. WINDER, of Newburyport.

1. *John White*, b. Sept. 1, 1850.
- 413 10. ANDREW JACKSON, b. Sept. 1, 1829; of Methuen; m., in 1851, CATHERINE EMERSON, dr. of Jacob and Lois E., of Pelham, N. H.
1. *Frank Edward*, b. Ap. 21, 1852.
-
111. 414 (VI.) JAMES WHITE, of Boston until 1816, when he moved to Hampden, Me., and engaged in agriculture. He m. (1st), ABIGAIL CONVERSE, dr. of Amasa Converse, of Marlboro, N. H. She d. Sept. 27, 1803, aged 32, and he m. (2d), Oct. 15, 1804, Mrs. SUSAN RAND, b. Sept. 18, 1780, dr. of Wait Atwood, of Plymouth, Mass. He d. in 1852, aged 78. Chil.,
1. STILMAN, b. Sept. 10, 1800, d. Aug. 24, 1835.
2. NABBY [Abigail], b. July 21, 1803, d. Sept. 22, 1805.
- 415 3. SALLY (twin), b. July 21, 1803; m., Ap. 29, 1823, THOMAS P. STETSON, a farmer, of Hampden, Me., b. Feb. 1, 1797, son of Simeon Stetson, Esq., of Washington, N. H. Chil.,
- 416 1. *John*, b. Ap. 4, 1825. 2. *James White*, b. Mar. 14, 1829.
418 3. *Simeon*, b. Ap. 17, 1832. 4. *Stilman White*, b. Aug. 29, 1834.
(By 2d wife.)
- 420 4. JAMES, b. Aug. 20, 1805, a clothier, in Hampden, Me., where he d., Sept. 30, 1828, aged 23. He m., Mar. 28, 1827, DEBORAH THOMAS, who d. Jan. 30, 1837, leaving one son.
- 421 5. CHARLES AUSTIN, b. Dec. 19, 1806; a merchant, of Boston, residing in Roxbury; m., July 15, 1829, ANN EATON, dr. of Nathan Eaton. Chil., 1. *Charles A.*
2. *James Cushing*. 3. *William Augustus*. 4. *Caroline Davis*. 5. *Frances Anne*.
6. *Henry Theodora*. 7. *John Earle*. 8. *Edward Peters*. 9. *Marion Simmons*.
10. *Alice Goodrich*.
- 422 6. SUSAN RAND, b. July 12, 1808; m., Aug. 13, 1835, JOHN L. PLUMMER, a merchant, of Boston, residing in Rox., b. Nov. 11, 1811, son of Nathaniel Plummer, of Bowdoin, Me. Chil.,
1. *Susan Augusta*, b. in Bangor, Me., June 16, 1838.
2. *John Franklin*, b. in Boston, Oct. 2, 1840.
3. *Charles Henry*, b. in Rox., Oct. 28, 1842, d. Oct. 27, 1845.
4. *Susan White*, b. in R., Oct. 12, 1844, d. Nov. 17, 1845.
5. *Albert Turner*, b. in R., Ap. 13, 1846.
6. *Elizabeth White*, b. in R., Mar. 5, 1848.
- 423 7. THOMAS ATWOOD, b. Dec. 29, 1810; a merchant, of Bangor, Me.; m., Aug. 16, 1832, LOUISA B. HARTWELL, dr. of Rev. Jonas Hartwell. Chil.,
1. *Thomas B.*, b. Aug. 4, d. Sept. 10, 1833.
2. *Ellen L.*, b. Ap. 28, 1835, d. Feb. 23, 1839.
3. *Frances M.*, b. Jan. 8, 1837. 4. *Cornelia F.*, b. Mar. 10, 1839.
5. *Eduard H.*, b. June 16, 1841. 6. *Thomas Herbert*, b. Oct. 5, 1843.
7. *Susan Louisa*, b. Nov. 22, 1845. 8. *Alice*, b. Sept. 5, 1848.
- 424 8. WILLIAM AUGUSTUS, b. Feb. 28, 1813; a merchant, of Boston, residing in Roxbury; m., June 3, 1836, LUCY JACKSON. Chil.,
1. *William White*, b. Feb. 28, 1837. 2. *Henry*, b. May 15, 1839.
3. *Harrison*, b. Ap. 30, 1841. 4. *Augustus*, b. Ap. 22, 1843.
5. *Lucy J.*, b. May 17, 1844, d. Ap. 11, 1845.
6. *Louisa*, b. July 21, 1846.
- 426 9. JOSEPH CURTIS, b. Dec. 12, 1814; a merchant, of Bangor, Me.; m., Sept. 8, 1835, MARY ANN GARNSEY, dr. of Benjamin Garnsey. Chil.,
1. *Mary Elizabeth*, b. July 16, 1838. 2. *Isaac Davis*, b. Aug. 7, 1840.
3. *George Boardman*, b. Aug. 17, 1842. 4. *Ellen*, b. Nov. 7, 1843.
5. *Joseph Curtis*, b. Aug. 25, 1845. 6. *Henrietta Shuck*, b. Aug. 27, 1847.
- 427 10. HEMAN LINCOLN, b. Nov. 4, 1822; a merchant, of Boston, residing in Roxbury; m., July 21, 1845, LUCY M. DUNBAR, dr. of Rev. Duncan Dunbar. Chil.,
1. *Katherine Louisa*, b. Nov. 4, 1846, d. Mar. 15, 1847.
2. *Mary Dunbar*, b. Jan. 21, 1849.
11. BENJAMIN FRANKLIN, b. Aug. 19, 1825, d. Dec. 19, 1827.
-
132. 430 (VI.) Hon. BAILEY BARTLETT, of Haverhill, b. Jan. 27, 1750, son of Edwin Bartlett, of Haverhill; m., Nov. 21, 1786, PEGGY WHITE. He d. Sept. 9, 1830, and she d. Oct. 15, 1831. He was Rep. of Haverhill, 1783; State Senator from

Essex Co., 1789; and in July of that year, Gov. Hancock appointed him High Sheriff of that County, which office he held, with the exception of a few months (from Dec. 5, 1811, to June 20, 1812, under Gov. Gerry), until his decease. In 1812, he was elected County Treasurer. He was a member of the Convention that adopted the Constitution of the United States, and of that which revised the Constitution of Massachusetts, in 1820. He was a member of Congress, for Essex District, 1797 to 1801; was a candidate for Presidential elector in 1804, and he was elected to that office in 1828. He had 15 children, of whom 13 arrived to middle age, and 4 survived him, viz.:

- 431 1. ANNA BAILEY, b. Aug. 24, 1787; m., May 5, 1817, Hon. WILLIAM JARVIS, formerly of Boston, latterly of Wethersfield, Vt. She was his 2d wife. Chil.,
- 432 1. *Ann Eliza*, b. June 30, 1818; m., Sept. 11, 1844, Hon. *Samuel Dinsmore*, of Keene, N. H. (son of Gov. Samuel Dinsmore); grad. Dart. Coll., 1814; Gov. of New Hampshire. She d. July 17, 1849.
- 433 1. William Jarvis, b. Ap. 17, 1846. 2. Samuel, b. Aug. 26, 1847.
- 435 2. *Harriet Bartlett*, b. Feb. 8, 1820; m., Aug. 9, 1843, Rev. *Jonas De Forest Richards*, grad. Dart. Coll., 1836; tutor in Marietta Coll.; afterwards pastor of a church in Chester, N. H. Chil.,
1. William Jarvis, b. June 11, 1844; d. Oct. 21, 1849.
- 436 2. *Jonas De Forest*, b. Aug. 6, 1846. 3. *Anna Bartlett*, b. Ap. 18, 1849.
- 438 4. *Jarvis*, b. Sept. 10, 1852.
- 439 3. *Charles S.*, b. Aug. 21, 1821.
4. *William*, b. Mar. 9, 1823; d. Aug. 14, 1825.
- 440 5. *Thomas Jefferson* (afterwards named *William*), b. Sept. 4, 1824; d. Jan. 1, 1842.
- 441 6. *Sarah*, b. July 20, 1826; m., Oct. 30, 1848, *Samuel G. Jarvis, Jr.*, M.D., of Claremont, N. H., son of Samuel G. Jarvis, M.D., late of Claremont. Chil.,
1. William, b. Sept. 16, 1849. 2. Leonard, b. Aug. 1, 1852.
- 442 7. *Margaret* (twin), b. July 20, 1826; d. July 6, 1847.
8. *Catherine*, b. Mar. 16, d. Ap. 11, 1830.
- 443 9. *Louisa Bartlett*, b. May 29, 1835.
- 444 2. ELIZA, b. Mar. 1, 1789; m., Aug. 31, 1808, JOSEPH E. SPRAGUE, Esq. She d. Ap. 16, 1817. [See [259], p. 505, and Part II.]
- 445 3. MARGARET, b. Aug. 29, 1790; m., Nov. 5, 1819, Dr. RUFUS LONGLEY, of Haverhill, M.B. Dart. Coll., 1811; M.M.S.S. Chil.,
- 446 1. *Margaret*, b. Dec. 22, 1820; d. Oct., 1842. 2. *Wm. Rufus*, b. Dec. 26, 1822.
- 447 3. *James*, b. Oct., 1824. 4. *Caroline*, b. Aug., 1826.
4. HARRIET, b. Mar. 9, 1792; d. Jan. 29, 1820.
- 449 5. SARAH LEONARD, b. Mar. 3, 1793; m., May 3, 1819, JOSEPH E. SPRAGUE, Esq., whose 1st wife was her sister Eliza, q. v.
- 450 6. BAILEY, b. Oct. 20, 1794; of Lawrence, has been Deputy Sheriff; m., June 20, 1843, CAROLINE LYMAN, of Hopkinton. Chil.,
- 451 1. *Abba Maria*, b. Mar. 14, 1844. 2. *Catherine*, b. Mar. 12, 1848.
- 453 7. CATHERINE, b. Nov. 15, 1795; m., Oct. 20, 1847, Hon. JOHN MEACHAM, of Castleton, Vt.; Judge of Probate. His first wife was Sarah White. [130.]
- 454 8. EDWIN, b. Dec. 22, 1796; a wealthy merchant, of N. York, residing in Tarrytown; m., in Portland, Mar. 3, 1832, CAROLINE E. HARROD, of P., s. p.
9. MARY, b. Aug. 10, 1799; d. Mar. 11, 1802.
- 455 10. ABBEY OSGOOD, b. May 7, 1801; m. Rev. MOSES KIMBALL; (?) grad. Dart. Coll., 1826; minister at Ascutneyville, Vt., s. p.
- 456 11. CHARLES LEONARD, b. Aug. 15, 1802; formerly of Haverhill, and Cashier of the Merrimack Bank; now a prosperous merchant, of Boston, but having his residence in Winthrop; m., in 1833, HARRIET, dr. of Hiram Plummer, of Haverhill. Chil.,
- 457 1. *Eliza Plummer*, b. in H., May 1, 1838. 2. *Wm. Frances*, b. June 6, 1840.
- 459 3. *Anna De Wolf*, b. Feb. 7, 1842. 4. *Harriet Louisa*, b. Aug. 7, 1844.
- 461 5. *Fanny*, b. May 29, 1849. 6. *Edith*, b. in Boston, Mar. 4, 1852.
- 463 12. MARY AUGUSTA, b. Aug. 6, 1804; m., Oct. 5, 1830, Hon. JOHN TENNEY; grad. Dart. Coll., 1824; a lawyer, of Methuen; Rep. and Senator, in Mass. Legislature, and member of the Executive Council. She d. Ap. 8, 1853. Chil.,
- 464 1. *Margaret Bartlett*, b. Nov. 5, 1831; d. Aug. 28, 1839.
2. *Edward Jarvis*, b. Sept. 20, 1833; grad. Harv. Coll., 1853.

- 465 3. *Eliza Sprague*, b. July 26, 1835. 4. *Mary Augusta*, b. Aug. 5, 1837.
 13. *FREDERICA AUGUSTA*, b. July 29, d. Aug. 16, 1805.
 467 14. *FRANCIS*, b. Oct. 26, 1806; m., July, 1837, *CAROLINE E. KNEELAND*, of West-
 ford. He d. Sept. 21, 1848, leaving one child.
 468 1. *Sarah Augusta*, b. 1838.
 469 15. *LOUISA AMELIA*, b. Oct. 17, 1809; m., Nov. 20, 1831, *OLIVER CARLTON*; grad.
 Dart. Coll., 1824; Master of the Grammar School in Salem. She d. June 28,
 1840. Chil.,
 1. *Edwin Bartlett*, b. Nov. 21, 1832; d. Nov. 19, 1851.
 2. *Wm. Jarvis*, b. May 12, 1835. 3. *Joseph George Sprague*, b. Aug. 10, 1837.
 4. *Mary Louisa*, b. Oct. 16, 1838.

PHILLIPS [41], APP. II.—ABBOT.

- 1 (IV.) Capt. *GEORGE ABBOT*, of Andover (b. Dec. 22, 1692, son of Capt. George
 and Dorcas (Graves) Abbot, and grandson of George and Hannah (Chandler)
 Abbot, of Andover); m., 1721, *MARY PHILLIPS* [Phillips, 41]. He lived with
 his father on the old homestead. He d. Mar. 17, 1768, in his 76th year, and his
 wid. d. Oct. 5, 1785, aged 91. [See Reg. of Abbot Family, pp. 1, 22, 25, &c.]
 2 1. *MARY*, b. Mar. 12, 1722-3; d. Aug. 8, 1798; m. *STEPHEN ABBOT*.
 3 2. *GEORGE*, b. Dec. 14, 1724; d. Dec. 26, 1775; lived with his father on the home-
 stead; was a Colonel, and Justice of the Peace. He m., 1747, *HANNAH LOVE-
 JOY*, who d. Sept. 7, 1813, aged 89. Chil.,
 4 1. *George*, b. Feb. 9, 1748; d. Oct. 5, 1784; of Salem; m. *Priscilla Manning*.
 5 2. *Hannah*, b. Oct. 25, 1749; d. May 27, 1784; m. 1773, *Joseph Ballard*. 2
 sons and 2 da.
 3. *Mary*, b. and d. 1751.
 6 4. *Mary*, b. June 9, 1753; d. Aug. 17, 1820; m. Dea. *Joseph Poor*, of Danvers.
 Chil.,
 7 1. *Joseph*, father of Ebenezer Poor; grad. Dart. Coll., 1818; minister of
 the 2d church in Beverly.
 8 2. *Mary*. 3. *Hannah*. 4. *Enoch*. 5. *Sally*. 6. *Nathan*.
 13 7. *Daniel*; grad. Dart. Coll., 1811, S.T.D.; Missionary of the A. B. C.
 Foreign Miss. in Ceylon, and President of Batticota College; d. 1855.
 14 8. *Martha*. 9. *George A.* 10. *Nancy*.
 17 5. *Elizabeth*, b. July 10, 1755; d. Aug. 18, 1821; m. *Samuel Lummus*, of
 Hamilton, Mass. 8 children.
 18 6. *John Lovejoy*, b. Ap. 12, 1757; d. Nov., 1837; a magistrate; lived on his
 father's homestead. He m. *Phebe*, dr. of Nehemiah Abbot. She d. Oct.,
 1825, aged 62. Chil.,
 19 1. *John L.*, b. Nov. 29, 1783; grad. Harv. Coll., 1805; Librarian 1811-13;
 minister of the first church in Boston; d. Oct. 14, 1814; m. *Elizabeth*
B. Warland.
 20 2. *George*, b. Ap. 25, 1785; d. Oct. 21, 1822; a Captain; lived with his
 father on the homestead; m. *Ruth Dixon*. Chil.,
 1. *Margaret W.*, b. Feb. 9, 1811; d. Aug. 25, 1813.
 2. *George*, b. Oct. 4, 1813; d. Ap., 1829.
 3. *Mary Wood*, b. Nov. 26, 1815. 4. *Elizabeth*, b. Nov. 15, 1817.
 5. *John*, b. Mar. 26, 1820; d. Jan. 14, 1821.
 6. *John L.*, b. Mar. 9, 1822.
 24 3. *Samuel*, b. June 29, 1787; a merchant, of Charlestown, Mass.; m.
Lucretia Fowle. Chil.,
 1. *Ann M.* 2. *Lucretia*. 3. *Sarah*. 4. *Samuel*.
 28 4. *Phebe*, b. June 15, 1789; d. 1811.
 5. *Lydia Clark*, b. July 10, 1791; d. Mar. 16, 1796.
 29 6. *Hannah*, b. Feb. 19, 1793; m. *E. L. Herrick, Esq.*, of Rockford, Ill.
 1. *Phebe A.* 2. *John W.* 3. *Elijah L.* 4. *Edward*. 5. *Hannah*.
 6. *George*. 7. *Sarah*. 8. *Martha*. 9. *Samuel*.
 7. *William L.*, b. Jan. 6, 1795; d. Mar. 27, 1796.
 30 8. *Sarah K.*, b. July 7, 1797; m. (1st) *Hezekiah Hull*, of La. She m.
 (2d) *Sidney Hull*, of N. Haven, Conn.

- 31 9. William, b. Dec. 16, 1799; of Charlestown; m. (1st) Amelia Hull, and m. (2d) E. M. Bradley.
7. Samuel, b. and d. July, 1759.
- 32 8. Samuel, b. July 19, 1760; d. May 8, 1792; grad. Harv. Coll., 1784; a merchant, of Saco, Me; m. *Mary Cutts*. Chil.,
1. Samuel Phillips, d. 1813. 2. Thomas Cutts, d. young.
- 33 9. Sally, b. Oct. 3, 1762; m. *Nehemiah Abbot*, who d. Dec. 30, 1823, s. p. She is the founder of the Abbot Female Academy, of Andover.
- 34 10. Martha, b. Oct. 17, 1764; d. Sept. 15, 1798; m. *John Jenks*, of Salem.
1. Priscilla. 2. Martha. 3. Hannah.
- 38 11. Dorcas, b. Dec. 18, 1766; d. Mar. 15, 1841; m. Dea. *John Holt*, of Greenfield. Chil.,
1. Dorcas, b. Jan. 12, 1793; m. Dea. Peter Pevey.
2. Sarah, b. Mar. 10, 1795; m. F. Duncklee.
3. Hannah, b. Sept. 15, 1797; d. Nov. 10, 1821.
4. John, b. Aug. 9, 1799; a deacon; m. Phebe Holt.
5. Tamezin, b. Nov. 23, 1803. 6. Phebe, b. Jan. 29, 1806.
7. Martha, b. Ap. 24, 1808; m. Arnold Hutchinson.
8. —, b. Ap. 2, 1811; d. June 20, 1830.
- 46 12. Tamezin, b. Jan. 14, 1769; m. *William Appleton*, of Salem.
3. ELIZABETH, b. Sept. 14, 1726; d. Jan. 7, 1727.
- 47 4. ELIZABETH, b. Nov. 5, 1727; m. (1st) BENJAMIN ABBOT, of Hollis. She m. (2d) J. POLLARD, of Westford. She m. (3d) Capt. JOSIAH BOWERS, of Billerica.
- 48 5. SARAH, b. Jan. 14, 1730; d. Dec. 26, 1797; m., 1757, Rev. NATHAN HOLT, of Danvers; grad. Harv. Coll., 1757; d. 1792. Chil.,
49 1. Sarah, b. Oct. 29, 1758; d. Sept. 17, 1841; m., 1778, *William Frost*, of Andover. 6 sons and 6 daughters.
50 2. Mary, b. Oct. 3, 1761; m. ROBERT ENDICOTT, of Beverly, who d. Mar. 6, 1819, aged 63. 4 sons and 1 daughter.
- 51 3. Hannah, b. May 11, 1769; m., 1793, Rev. Peter Holt, b. in Andover, Mass., June 12, 1763; grad. Harv. Coll., 1790; of Epping, N. H., from 1793 to Ap., 1821, afterwards of Peterboro. 4 sons and 3 daughters.
- 52 6. SAMUEL, b. Feb. 25, 1732. He was a merchant, of Boston, from 1753 to the commencement of the Revolution; when, being a whig, he moved his goods from Boston, sold them, received much of his pay in paper money, which he loaned to the government. He kept his government securities and funded them. By doing this, by his prudence in business, and by his frugal habits, his property continued to accumulate, until it amounted to a large estate. He m. wid. SARAH KNEELAND. He d. Ap. 12, 1812, s. p., aged 80, and his wid. d. Feb. 16, 1816, aged 89. Besides many smaller benefactions, he established and endowed a Professorship in Andover Theol. Seminary; and by his Will, after making legacies to his near relations, he made that Institution his residuary legatee, which residuary legacy amounted to about one hundred thousand dollars.
- 53 7. HANNAH, b. Dec. 14, 1733; d. Mar. 26, 1820; m. WILLIAM FOSTER. Chil.,
54 1. Hannah, b. June 20, 1756; m. Capt. *Timothy Rogers*, of Tewksbury. Chil.,
55 1. Timothy Foster, b. Mar. 16, 1781; grad. Harv. Coll., 1802; ordained in Bernardston, Sept. 20, 1809; d. 1847.
56 2. William, b. June 1, 1758; d. Aug. 20, 1843; m. *Sally Kimball*.
57 3. Mary, b. July 21, 1763; m. *Timothy Ballard*, s. p.
58 4. Sally, b. Sept. 9, 1765; m. *Joseph Brown*, of Tewksbury.

PHILLIPS [43‡], APPENDIX III.—JEWITT.

- 1 (IV.) Rev. DAVID JEWITT,* of Rowley, Mass., b. June 10, 1714, grad. Harv. Coll. 1736, ordained pastor of the Second Church in New London (now Montville), Conn., Oct. 3, 1739; d. June 6, 1783, aged 69. Before going to New London, he was employed as a missionary to the Mohegans, and acquired the favor of the sachem and tribe. "No minister in the country stood higher among his own flock, or in the esteem of his brethren, than Mr. Jewitt. He was a man of dignified deportment, rigorous in discipline, but very fervent in his preaching, and uniformly assiduous in his calling." [Caulkins' History of New London, p. 434.] He was a chaplain in the army in 1756, often afterwards in the French War, and in the Revolution. He m. PATIENCE PHILLIPS [43‡]. She d. in 1773, and he m. (2d), MARY —, s. p. In the church record, he says: "I was recommended to this church from the Church of Christ, in Rowley, the Rev. Mr. Jewitt, Pastor." "My wife, Patience, was recommended from the church in Salem, Mr. Fisk, Pastor." The tradition is, that he became engaged to Miss Phillips while he was a student of theology; that he was very ill, and she, being a member of the same family, nursed him so kindly and assiduously as to produce a life-long and loving attachment between them. The tradition of the origin of this attachment has been preserved in his parish, to account for his marrying a lady born with only one hand, and about ten years older than himself. His Will, dated a short time before his decease, mentions his wife Mary; son David Hibbert Jewitt, and my gr. chil., David, Charles, Elizabeth, and Sarah Jewitt; "my dear son-in-law, Elisha Porter, Esq., of Hadley," and my gr. chil., Samuel and Sarah Porter. This New London branch have changed the ancient orthography *Jewett* to *Jewitt*. [See Hist. of Rowley, and Catalogue of Harv. College.] Chil.,
4. 2 1. SARAH, b. Aug. 25, 1741; m. ELISHA PORTER, Esq., of Hadley.
28. 3 2. DAVID HIBBERT, b. Aug. 21, 1745; a physician, of New London.
-
2. 4 (V.) Col. ELISHA PORTER, Esq., b. Feb. 9, 1742; grad. Harv. Coll. 1761, High Sheriff of Hampshire Co., Mass.; m. (1st), May 13, 1762, SARAH JEWITT. She d. Ap. 5, 1775, and he m. (2d), Mar. 19, 1773, ABIGAIL PHILLIPS [102‡], of Boston. She d. Mar. 2, 1791, s. p., and he d. May 29, 1796. Chil.,
- 5 1. SARAH, b. Ap. 29, 1763, d. Mar. 19, 1831; m., Oct. 7, 1781, DAVID HILLHOUSE, a merchant. Chil.,
- 6 1. Mary, m. — *Shepherd*. Numerous children.
- 7 2. Sarah, m. — *Gilbert*, of Washington, Ga. Both d.
- 8 1. Sarah, m. Adam Leopold Alexander, of Washington, Wilkes Co., Ga.
- 9 3. *Daniel Kellogg*.
- 10 4. *David Porter*, a planter, of Washington, Ga.; m. twice, and d. s. p.
- 11 5. *Thomas*. 6. *William*. 7. *Caroline Sophia*.
- 12 2. SAMUEL, b. Ap. 15, 1765; a general and a farmer; m., Oct. 26, 1786, LUCY HUBBARD, b. Feb. 28, 1764. He d. Ap. 23, 1841, and she d. Jan. 23, 1848. Chil.,
- 13 1. *Margaret*, b. Feb. 9, 1787; m., Oct. 11, 1810, Rev. *Seth Smith*, b. July 4, 1785; grad. Yale Coll. 1803; settled in Genoa, N. Y., where he d., Jan. 1849. Chil.,
- 14 1. *Margaret*, b. Feb. 1813, d. young.
2. *Margaret*, b. May 21, 1815, d. Dec. 28, 1849; m., Sept. 18, 1842, *Isaac Peck*, a farmer. Chil.,
- 15 1. *Harriet*, b. Oct. 11, 1843, d. 1844. 2. *Samuel*, b. May 13, 1845.

* (I.) MAXIMILIAN JEWETT, of Rowley, adm. freeman May, 1640, Rep. 1641, and sixteen years afterwards, was living in 1682. By wife SARAH, he had one son, *Ezekiel*, b. 1643, and six daughters.

(II.) EZEKIEL JEWETT (son of Maximilian), adm. freeman May, 1680; a Deacon; Rep. of Rowley, 1690; d. Sept. 2, 1723, aged 80. He m. FAITH PARSON, and had 6 sons, viz., 1. *Francois*, b. 1686. 2. *Thomas*, b. 1686. 3. *Ezekiel*, b. 1690. 4. *Maximilian*, b. 1672. 5. *Nathaniel*, b. 1681. 6. *Stephen*, b. 1683; and three daughters.

(III.) STEPHEN JEWETT, of Rowley (son of Ezekiel), m. (1st), July 12, 1708, PRISCILLA JEWETT. She d. Dec. 28, 1722, and he m. (2d), Nov. 23, 1726, LYDIA ROBERTS. Chil.,

1. *Phebe*, b. Nov. 2, 1709. 2. *Eliphalet*, b. Jan. 22, 1711-12.

3. *David*, b. June 10, 1714; grad. Harv. Coll. 1736; minister of N. London.

4. *David* (twin), b. June 10, 1714. 5. *Solomon*, b. Sept. 2, 1716. 6. *Ezekias*, b. Feb. 1, 1718-19.

7. *Elisabeth*, b. June 17, 1721.

(By 2d wife, Lydia.)

8. *Priscilla*, b. June 30, 1727.

- 17 3. Harriet Adeline, b. Nov. 3, 1847. 4. Edward Smith, b. Dec. 8, 1849, d. 1852.
3. Lydia, b. Ap. 14, 1817, d. June 29, 1841.
4. Eliza Bradshaw, b. Aug. 1, 1819, d. Sept. 1838.
5. Lucy, b. Aug. 3, 1821, d. Feb. 22, 1844.
6. Julia, b. Aug. 11, 1823. 7. Abigail, b. Ap. 7, 1825.
8. Harriet, b. Feb. 1827, d. 1839. 9. Susan Hubbard, b. Nov. 9, 1828.
- 18 2. *Abigail*, b. Oct. 18, 1788.
- 19 3. *Lucy*, b. Ap. 13, 1791; m., Nov. 11, 1812, Dea. *Nathaniel Coolidge*, a merchant. [*Coolidge*, 267, and Part II.] She d. June, 1825, and he d. Ap., 1835. Chil.,
1. Samuel, b. Sept. 1814, d. 1816. 2. Sarah Porter, b. 1818, d. 1840.
3. Lucy, b. 1822, d. 1826. 4. John Baldwin, b. May, 1825, d. soon.
- 20 4. *Elisha*, b. May 22, 1794. 5. *Polly*, b. Ap. 4, 1796, d. Dec. 13, 1847.
- 21 6. *Pamela*, b. May 7, 1797; m., Dec. 5, 1822, *Dudley Smith*, a merchant, b. Nov. 6, 1793. Chil.,
1. Samuel Porter, b. June 26, 1824, d. Aug. 16, 1825.
2. Lucy, b. Sept. 18, 1826, d. Aug. 16, 1828.
3. *Dudley Porter*, b. Aug. 21, d. Oct. 29, 1828.
- 22 4. John Porter, b. Oct. 11, 1829, grad. Amh. Coll. 1849; a lawyer, of Chicago.
5. Sarah Hillhouse, b. Aug. 7, 1831. 6. Abby Phillips, b. Aug. 26, 1833.
- 23 7. *Clariissa Alexander*, b. Jan. 11, 1836.
- 25 8. *Lucy Coolidge*, b. May 8, 1839.
- 26 9. *Samuel Dudley*, b. May 30, 1843.
- 27 7. *Sarah Jewitt*, b. Jan. 15, 1800, d. Sept. 3, 1804.
8. *Samuel Phillips*, b. Feb. 16, d. Sept. 11, 1802.
9. *Eliza*, b. July 18, 1803, d. May 29, 1804.
10. *Samuel Phillips*, b. Mar. 22, 1806, d. Aug. 6, 1829.
3. DAVID, b. June 13, 1767, drowned June 8, 1775.
4. MARY, b. Ap. 8, 1769. 5. Lucy, b. Oct. 18, 1770.
6. PATIENCE, b. Ap. 19, 1773; all d. in infancy.
-
3. 28 (V.) Dr. DAVID HIBBARD JEWITT, educated at Cambridge, without proceeding to a degree; studied medicine with Dr. E. A. Holyoke, and settled in New London, N. Parish (now Montville), Conn. He m., in Aug. 1769, PATIENCE BULKLEY, b. Ap. 23, 1749, dr. of Major Charles and Ann (Latimer) Bulkley, of Colchester, Conn., gr. dr. of Rev. John and Patience (Prentice) Bulkley, first minister of Colchester, and a gr. granddr. of Rev. Gershom and Sarah (Chauncy) Bulkley, 2d minister of New London, afterwards of Weathersfield. Dr. Jewitt served as a surgeon in the Am. Army during most of the Revolutionary War. He d. in his native town, Ap. 26, 1814, and the next year his family moved to Wilkesbarre, Penn., where his wid. Patience d., Feb. 1830. Children, all b. in N. Parish of N. London.
-
1. PATIENCE, b. Sept. 1770, d. aged 7 yrs. 4 m.
- 29 2. DAVID, b. June 17, 1772, "a man of uncommon powers of body and mind," and imbued with the romantic, adventurous disposition of a knight-errant. He read law with Gov. Griswold, but early entered the U S. Navy, and soon attained the rank of Captain. In the French War, of 1798, he commanded the ship *Trumbull*, of 18 or 20 guns, and sent home several prizes. He became disgusted with what he considered the maltreatment of the Government, and, after the reduction of the American Navy, in 1801, he enlisted in the service of the Buenos Ayrean Government, and served in it until its independence was established. After this, he enlisted in the service of Don Pedro, Emperor of Brazil, and was, it is said, the first to raise for him the flag of independence. He was second in command when Lord Cochrane was Admiral of the Brazilian Navy. About 1827, he was sent to New York by the Emperor of Brazil, to contract for and oversee the building of, two ships of war for that government. While in N. York, he m., in the autumn of 1827, Mrs. ELIZA M'TIERS, dr. of Alderman Augustine H. Lawrence, of New York. He returned to Rio Janeiro, where he d., in July, 1842, and his wid. survived him only a few months. Chil.,
- 30 1. *Augustin David Lawrence*, b. in Wilkesbarre, Jan. 12, 1830, grad. Williams

- Coll. 1852, now (1854), mem. of Theol. Sem., Princeton. After the decease of his father, he lived in the family of his uncle, Judge Collins, of Wilkesbarre, his testamentary guardian.
3. ANNA. 4. CHARLES BULKLEY; both d. in infancy.
- 31 5. CHARLES, b. June 9, 1777; attained the rank of Lieut. in U. S. Navy, but his health failed in early life, and in 1816 he went to Wilkesbarre, where he d., Feb. 14, 1825, unm.
- 32 6. ELIZABETH, b. Oct. 9, 1780; m., in Wilkesbarre, Penn., Mar. 31, 1814, PHINEAS WALLER, a farmer, of Wyoming, Luzerne Co., Penn., b. 1773, son of Nathan and Elizabeth (Weeks) Waller. Both are now (1854) living. Chil.,
- 33 1. *David Jewett*, b. Jan. 16, 1815, grad. Williams Coll. 1834; at Princeton Theol. Sem. 1837; ordained and installed pastor of the Presbyterian Church in Bloomsburg, Penn., May, 1839. He m., May 23, 1839, *Julia*, youngest dr. of Levi and Hannah (Hopkins) Ellmaker, of Philadelphia. Chil.,
- 34 1. Hannah Ellmaker, b. Aug. 30, 1840.
2. Elizabeth, b. in Philadelphia, Mar. 14, d. July 19, 1842.
3. Maria Louisa, b. May 29, 1843, d. Feb. 28, 1844.
4. Harriet, b. Nov. 16, 1844, d. June 13, 1845.
- 35 5. David Jewett, b. June 17, 1846.
6. William Paterson, b. Jan. 20, d. Ap. 22, 1848.
- 36 7. Levi Ellmaker, b. July 16, 1851.
- 37 8. George Phillips, b. Ap. 2, 1854.
- 38 2. *Harriet Maria*, b. Feb. 10, 1817; unm.
- 39 3. *Charles Phillips*, b. Aug. 7, 1819; two years a student of Williams College, two years teacher of an Acad. in Bloomsburg, Penn.; studied law with Judge Collins, and settled in Honesdale, Penn.; m., Ap. 3, 1845, *Harriet Ward Stone*, dr. of Henry W. and Catherine (Niven) Stone. Chil.,
- 40 1. Elizabeth Jewett, b. June 10, 1846.
- 41 4. *George Grant*, b. May 3, 1821; grad. Williams Coll. 1844; studied law with Judge Collins, and settled in Honesdale, Penn.
5. *Martha Hannah*, b. Feb. 12, 1825, d. Ap. 14, 1826.
- 42 7. SARAH, b. Oct. 8, 1782.
- 43 8. GEORGE, b. May 22, 1785; a merchant, at Tunkhannock; d. in Wilkesbarre, Nov. 2, 1816, unm.
- 44 9. ANN, b. July 6, 1787; m., July 17, 1823, Hon. ORISTUS COLLINS, of Wilkesbarre.
- 45 1. *Charles Jewitt*, b. June 25, 1825; grad. Williams Coll. 1845; tutor there two years; grad. Princeton Theol. Sem. 1854.
- 46 10. MARTHA (twin), b. July 6, 1787.
- 47 11. HARRIET, b. Jan. 10, 1790, d. in Wilkesbarre, Nov. 25, 1816, unm.

PHILLIPS [70], APP. IV.—SPOONER.

- 1 (V.) Dr. WILLIAM SPOONER, b. in Boston, Mar. 24, 1760, son of John, Jr., and Hannah (Jones) Spooner; gr. son of John Spooner, who came from England, and of John Jones, Esq.; grad. Harv. Coll., 1778; studied medicine with Dr Samuel Danforth, of Boston, and was a surgeon in ships of war, in 1781-2. In 1782, he went to Edinburgh to complete his professional studies, where he received the degree of M.D. in 1785. He returned to Boston in 1786, and immediately commenced the practice of medicine. He was a member of the Royal Med. Society, of Edinburgh; of the Mass. Med. Society; of the American Academy, and the Mass. Hist. Society; was several times Rep. and Senator in the State Legislature; a trustee of the Humane Society of Massachusetts, and a member of the Board of Overseers of Harvard University. He m., Oct. 21, 1788, MARY PHILLIPS [see 70, p. 878]. She d. Nov. 27, 1802, and he d. in Boston, Feb. 15, 1836, et. 76. Chil.,
1. JOHN PHILLIPS, b. July 11, d. Aug. 2, 1789.
2. WILLIAM, b. Aug. 29, 1790; d. Sept. 20, 1792.
- 2 3. MARY WINTHROP, b. Dec. 23, 1791; m., Mar. 22, 1813, GEORGE W. COFFIN, b. Jan. 16, 1784, son of Hon. Peleg Coffin, formerly of Nantucket. He was many

- years Land Agent of Massachusetts, and resided in Boston, but now (1854) is retired to Roxbury. Chil.,
- 3 1. *Mary Phillips* (Coffin), b. Feb. 24, 1814; m., Sept. 8, 1839, *Edward J. Warner*, merchant, of New York.
 - 4 2. *Eliza Symmes*, b. June 5, 1816; m., Mar. 6, 1839, *George E. Cook*, a broker, of New York, son of *Zebedee Cook, Esq.*, formerly of Boston. Chil.,
 - 5 1. *Mary Winthrop*, b. Sept. 9, 1842.
 - 6 2. *Caroline*, b. Aug. 14, 1849.
 - 7 3. *George Winthrop*, b. Feb. 3, 1818; m., Nov. 1, 1842, *Charlotte*, dr. of *Benjamin Howard, Esq.*, merchant, of Boston. He is connected in business with his father-in-law, and resides in Roxbury. Chil.,
 - 8 1. *Benjamin Howard*, b. Feb. 27, 1844.
 - 9 2. *Charles Winthrop*, b. Ap. 24, 1854.
 - 10 4. *William Spooner*, b. Jan. 31, 1820.
 - 11 5. *Henry Peleg*, b. Aug., 1828.
 - 12 6. *Anne Warren*, b. July 15, 1834.
 - 13 4. **WILLIAM JONES**, b. Ap. 15, 1794; grad. Harv. Coll. 1813, with distinguished honor; studied law at Litchfield Law School, afterwards with *Peter O. Thatcher, Esq.*, of Boston. He was a distinguished scholar; was Orator of the Phi Beta Kappa in 1822, and contributed several able articles to the *North Am. Review*; was a member of the *Mass. Hist. Society*. He d. Oct. 17, 1824, aged 30, unm. [For memoir of Mr. Spooner, see *Mass. Hist. Col.*, 3d Ser. I., p. 265.]
 - 14 5. **JOHN PHILLIPS**, b. Feb. 28, 1797; grad. Harv. Coll., 1817; and M.D. 1820, after having studied medicine with the late *Dr. G. C. Shattuck*, of Boston. He was engaged in the practice of medicine in Boston, from 1820 to 1831, when he removed to *Dorchester*, where he now (1854) resides. He is M.M.S.S. He m., Oct. 2, 1827, **ABBY ELIZABETH TUCKERMAN**, b. Aug. 11, 1805, dr. of *Rev. Joseph Tuckerman, D.D.* Chil.,
 - 15 1. *John Phillips*, b. Sept. 23, 1829; d. May 8, 1834.
 - 15 2. *Susan Elizabeth*, b. July 5, 1831; m., Ap. 6, 1853, *Charles Marshall Spring Churchill, Esq.*; grad. Harv. Coll., 1845; LL.B. 1848; a lawyer, of *Dorchester*.
 - 16 1. *Elizabeth Tuckerman*, b. Jan. 10, 1854.
 - 16 3. *Mary Phillips*, b. Sept. 24, 1833; d. Sept. 19, 1847.
 - 16 4. *Joseph Tuckerman*, b. Oct. 31, 1835; d. May 21, 1842.
 - 16 5. *Hannah Tuckerman*, b. Aug. 15, 1837; d. Ap. 21, 1838.
 - 16 6. *William Jones*, b. Mar. 14, 1839; d. July 20, 1841.
 - 17 7. *Francis Cunningham*, b. July 21, 1841.
 - 18 8. *Josephine Tuckerman*, b. Oct. 27, 1843.
 - 19 9. *John Winthrop*, b. Sept. 20, 1845.
 - 20 10. *George Phillips*, b. Mar. 23, 1849.
 - 21 6. **CHARLES**, b. Oct. 2, 1799; a farmer, of *Colchester, Delaware Co., N. Y.*; m., in *Boston*, in 1831, **ALMIRA TRACY**, of *Portsmouth, N. H.* One child, viz.,
 - 22 1. *Charlotte*, m. *Charles Ellenwood*.
 - 23 7. **FRANCIS JONES**, b. May 30, 1802; m., Dec. 19, 1826, **ANN KEARNEY WARREN**, b. Oct. 9, 1806, dr. of *John J. Warren, Esq.*, of *New York*. After pursuing mercantile business several years in *N. York*, he moved to *New Brunswick, N. J.*, where he d. May, 1848, and where his widow and surviving child, now (1854) reside. Chil.,
 - 24 1. *John Warren*, b. Dec., 1841, d. soon.
 - 24 2. *Annie Kearney*, b. Nov., 1843.
 - 24 3. *Mary Winthrop*, d. soon.

PHILLIPS [76], APP. V.—TILLINGHAST.

- 1 (IV.) **NICHOLAS TILLINGHAST**, 3d child of *Joseph and Lydia Tillinghast*, b. in *Providence, R. I.*, May 26, 1726. He was a merchant; town clerk of *Providence* in 1754, and probably some years before and after that; was a Judge of one of the courts, probably *C. C. P.* In 1777, he was imprisoned a few days, for

having in his possession a proclamation of Lord Howe, and refusing to say how he came by it. From some papers relating the affair, it is supposed that he had it from his brother. He became a follower of Robert Sandeman, who came from Scotland, and was the founder in this country of a sect called Sandemanians; the same that were called Glassites in Scotland. About the close of the war, or perhaps before, he moved to Taunton, Mass., where he d. Feb. 26, 1797, aged 70 yrs. 9 m. He was Postmaster of Taunton, during his several latter years. Although not educated in a college, he was a fine scholar, well versed in the Latin language, and in the literature of the day. He m. (1st) SUSAN DYER, who probably d. very soon, s. p. He m. (2d), Sept. 26, 1754, JOANNA ISACKS, who d. Mar. 30, 1757, leaving 2 chil. He m. (3d), Feb. 11, 1762, wid. RUTH (Phillips) EDWARDS, then aged 27 yrs. She d. in Taunton, Nov. 19, 1809, aged 74 yrs. 5 chil., viz. [the 2 children of his 2d wife not given]:

- 2 1. SUSANNA, b. July 9, 1763; m., Oct., 1781, JOHN WILSON SMITH, of Taunton, son of Job Smith. About 1804, he moved from Taunton to Roxbury, where he d. about 1807. She d. 1801. Chil.,
 - 3 1. *William Henry*, a literary man, now of Providence; Sec. of State, under Gov. Dorr, in 1842. 2 chil.,
 - 4 1. *Mary*, unm.
 - 5 2. *John Wilson*, unm.; many years Clerk of the Providence courts.
 - 6 2. *Susan*, a teacher; d. in Newport, about 1820.
 - 7 3. *Ruth Charlotte*, b. Nov. 13, 1788; m. *Richard Henry Dana*, Esq., of Cambridge, youngest son of Chief Justice Dana. She d. leaving 3 children.
 - 8 1. *Charlotte*.
 - 9 2. *Richard Henry*, grad. Harv. Coll. 1837, LL.B., 1839; a lawyer, of Boston, and a leader in the Free Soil party; author of "Two Years before the Mast," &c. &c.
 - 10 3. *Edmund Trowbridge*, grad. Vt. Univ., 1839; LL.B., Harv. Coll. 1841; a lawyer, of Boston.
 - 11 4. *Mary Elliot*, b. Aug. 5, 1788; d. about 1840, unm.
 - 12 5. *John Barney*, b. about 1796; Sec. of an Insurance Co.; d. about 1836, leaving several children. His wid. keeps a boarding-house in Boston.
 - 13 2. JOSEPH, b. Feb. 10, 1765; a trader, of Taunton, in company with his father, firm, Nicholas Tillinghast and son. Ap. 1797, about the time of his father's decease, he went to Goldsboro, Me., remained there four or five years, and returned to Providence, where he was for a short time Steward of Brown University. In 1804, he sailed from Prov. for the W. Indies, in a vessel which was never heard of after she left. About 1785, he m. NANCY HODGES, dr. of Abijah Hodges, of Taunton. Chil.,
 - 14 1. *Nicholas*, b. in Taunton about 1786. After many adventures, he went to Philadelphia, where he d., leaving wid. and children.
 - 15 2. *Charles*, b. in T., Sept. 7, 1787; m., about 1810, *Dulcinea*, dr. of Major Paul Nelson, of Bristol, R. I. As a clerk for Walter A. Dalton, he went to Vincennes, Ia., where he d. about 1820, leaving one child, Anna, who m. John A. Tompkins, of Pawtucket, who moved to Newbury, N. Y., and was drowned in attempting to jump from a steamboat to a wharf. His wid., with her widowed mother, are keeping a boarding-house in Providence.
 - 16 3. *Joseph Leonard*, b. in T., May 18, 1790; a lawyer, of Providence; Hon. A.M. Brown Univ. 1819, and Trustee; Rep. of Prov. in Gen. Assembly; member of Congress 6 years; "one of the best, kindest, most talented men of his age." He m. *Rebecca Power*, and d. June, 1845, leaving 2 drs., who live in Philadelphia, and one son, *Nicholas Power*, grad. Brown Univ. 1837, an Episcopal clergyman, of N. Carolina.
 - 21 4. *Joanna*, d. unm. 5. *Anna*, d. nrm.
 - 22 6. *Lydia*, m. — *Rogers*, a Methodist Episcopal clergyman, of Ohio.
 - 23 7. *Charlotte*, m. — *Dunn*, a M. Episc. Clergyman. She d. in New York.
 - 24 8. *Mary*, d. unm.
 3. NICHOLAS, b. in Prov., Jan. 24, 1767; A. M. Brown Univ. 1793, and Harv. Coll. 1807; a lawyer, of Providence, until about 1793, when he moved to Taunton, where he d., Ap. 24, 1818. He was 6 or 8 years Rep. of Taunton in Gen. Court; several times candidate for mem. Congress, but, being an active and influential Federalist, he was never elected. He m., Mar. 19, 1789, BETSEY ATWELL, b.

- Oct. 18, 1770, dr. of Amos and Betty Atwell, of Providence. She d. in Medfield, Mass., Mar. 18, 1834. Chil.,
- 25 1. *Funny*, b. in Prov., Dec. 7, 1789, d. in Taunton, May 10, 1817, unm.
- 26 2. *Amos Atwell*, b. in Prov., May 13, 1792; bred an accountant; from 1815 to 1850, cashier of a bank; m., in Pawtucket (where he resides), Sept. 24, 1824, *Mary U. Jerald*. To this gentleman I am indebted for the record of this branch of the Tillinghast family. Chil.,
- 27 1. *Frances*, b. May 15, 1826, d. May, 1853; m. June 11, 1849, *James Pratt*, b. in Bridgewater, Mar. 1, 1825; manager of a calico-printing establishment, in Manchester, N. H., family now (1853), residing in Pawtucket. Chil.,
1. *Emily*, b. Feb. 26, 1850. 2. *Charles Tillinghast*, b. Oct. 17, 1851.
3. *Mary*, b. Mar. 3, 1853.
- 28 3. *Mary*, b. in Taunton, July 15, 1794; m. *Paschal Allen*, of Warren, R. I. s. p.
- 29 4. *Susan*, b. in T., Jan. 7, 1797, d. Sept. 1818, s. p.
- 30 5. *Joanna*, b. in T., Nov. 1, 1799; m. *Silas Shepard*, of Taunton. Had one child, d. in infancy.
- 31 6. *Elizabeth Searle*, b. in T., Ap. 8, 1802, d. in Medfield, Jan. 1840.
- 32 7. *Nicholas*, b. in T., Sept. 30, 1804; educated at West Point Academy; Capt. in the 7th Reg. U. S. Infantry; several years stationed in Arkansas; now (1853), Principal of the Normal School in Bridgewater, Mass. He m. (1st) *Sophia Ritchie*, who d. soon after marriage. He m. (2d), *Ruby Potter*, s. p.
- 33 8. *William*, b. in T., July 31, 1806, lost at sea, in 1834.
- 34 9. *Joseph*, b. in T., Sept. 13, 1809, of Charlestown, Mass., m. *Cornelia Armington*, s. p.
- 35 10. *Ruth Phillips*, b. in T., Mar. 1814; lives with her brother N., unm.
- 36 4. *JOANNA*, b. Mar. 28, 1768; m., July 30, 1786, *JAMES HODGES*, brother of her brother Joseph's wife. She d. Oct. 5, 1791, leaving 2 children, and he d. 1810. Chil.,
- 37 1. *Charlotte*, b. Dec. 21, 1787; m., 1807, *Marcus Morton*, b. in Freetown, Mass., Feb. 1784, grad. Brown Univ. 1804; LL.D. 1826, and LL.D. Harv. Coll. 1840; four years member of Congress; fifteen years Judge of Sup. C.; one year Lieut. Gov., and two years Gov. of Mass.; 4 years collector of the Port of Boston. He settled in Taunton in 1807. Chil.,
- 38 1. *Maria*, m. *William Taber Hawes*, grad. Brown Univ. 1825.
- 39 2. *Lydia Mason*, m. *Rev. Henry Lee*, D.D., of Rochester, N. Y.
- 40 3. *Charlotte*, m. *Samuel Watson*, of Nashville, Tenn.
- 41 4. *Sarah Cary*, m. *Willard Lovering*, of Taunton.
- 42 5. *Marcus*, grad. Br. Univ. 1838; LL.B. Harv. Coll. 1840; a lawyer, of Boston; m. *Abby Hoppin*, of Providence.
- 43 6. *Nathaniel*, grad. Br. Univ. 1840; tutor; LL.B. Harv. Coll. 1848; a lawyer, of Taunton.
- 44 7. *James Hodges*, grad. Br. Univ. 1844; LL.B. Harv. Coll. 1846; a lawyer, of Springfield, Mass.; m. *Elizabeth Ashman*.
- 45 8. *Susan Tillinghast*, unm.
- 46 9. *Frances Wood*, m. *Charles Henry French*, of Andover, Mass.
- 47 10. *Emily Matilda*.
- 48 2. *James Leonard*, b. Ap. 24, 1790, d. Mar. 1846; of Taunton; member of Congress 1826 to 1832; m. *Harriet Little*, dr. of *Samuel Fales*, of Taunton. Many children; only 4 living, viz.,
- 49 1. *William Gray*, a merchant, of Taunton.
- 50 2. *Sarah*, m., and lives in Providence.
- 51 3. *Helen*, m., and lives in Maine.
- 52 4. *James Leonard*, of Chicago.
- 53 5. *WILLIAM*, b. July 29, 1770. In 1795, he went to N. Carolina, where he d., unm.

PHILLIPS [118], APP. VI.—QUINCY.

- 1 JOSIAH QUINCY, Jr., Esq., of Revolutionary renown, m., in Oct. 1769, ABIGAIL PHILLIPS [118], eldest child of Hon. William Phillips, and eldest sister of Lieut. Gov. William Phillips, of Boston. He was b. Feb. 23, 1744, the youngest son of Josiah Quincy, Esq., some time a merchant, of Boston, afterwards retired to a farm, at Mount Walliston (Braintree). He grad. Harv. Coll. 1763; A.M. Harv. and Yale, 1766; studied law with Oxenbridge Thatcher, Jr., and became a member of the Suffolk bar. He d. at sea, Ap. 26, 1775, on a return voyage from England, and his wid. d. Mar. 25, 1799. [For his respectable pedigree, and a full account of his talents, character, and life, see his Memoir, written by his son, and published in 1825.] Chil.,
1. a dr., d. Ap. 13, 1775, birth not ascertained; perhaps 2d child.
- 2 JOSIAH, b. Feb. 4, 1772; grad. Harv. Coll. 1790; LL.D. 1824; A.A.V. Pres.; S.H. and S.P.A.S.; President Harv. Univ. 1829 to 1845; Rep. of Boston in U. S. Congress, 1805 to 1813. [For an account of his numerous literary, civil, and military appointments and services, see Loring's One Hundred Boston Orators.] He m., in June, 1797, ELIZA SUSAN MORTON, b. in New York, Sept. 26, 1774, d. at Quincy, Sept. 1, 1850; a dr. of John Morton, Esq.,* an emigrant from the north of Ireland, and an eminent merchant, of New York.
- 3 1. *Eliza Susan*, unm.
- 4 2. *Josiah*, b. Jan. 26, 1802; grad. Harv. Coll. 1824; a counsellor-at-law; some years mayor of Boston; Pres. of Mass. Senate; m., Dec. 1827, *Mary Jane Miller*, dr. of Samuel R. Miller, Esq., a merchant, of Boston. Chil.,
- 5 1. Josiah Phillips, b. Nov. 1829; grad. Harv. Coll. 1850.
- 6 2. Samuel Miller, b. May, 1832; grad. Harv. Coll. 1852.
- 7 3. Mary Apthorp, b. Aug. 1834.
- 8 3. *Abigail Phillips*, unm. 4. *Maria Sophia*, unm.
- 10 5. *Margaret Morton*, m., May, 1826, *Benjamin D. Greene*, grad. Harv. Coll. 1812; A.A.S.; an eminent botanist, eldest son of the late Gardner Greene, Esq., of Boston, s. p.
- 11 6. *Edmund*, b. Feb. 1, 1808; grad. Harv. Coll. 1827; studied law in 1840; relinquished his profession, and retired to Dedham. He is much distinguished for his bold and uncompromising advocacy of "free men, free soil, free principles, and free trade." He m., Oct. 14, 1833, *Lucilla P. Parker*, dr. of Daniel P. Parker, Esq., a merchant, of Boston. Chil.,
- 12 1. Edmund, b. Aug. 11, 1834. 2. John H., b. Sept. 26, 1836.
- 14 3. Henry Parker, b. Oct. 27, 1838. 4. Mary, b. Ap. 23, 1841.
5. Morton, b. June 11, 1845, d. Mar. 10, 1849.
6. Arthur Bromfield, b. Ap. 9, 1847, d. Mar. 15, 1849.
- 16 7. *Anna Cabot Lowell*, m., Mar. 1840, Rev. *Robert Cassie Waterston*, of Boston; A.M. Harv. Coll. 1844; son of Robert Waterston, Esq., a merchant, of Boston, and a native of Scotland. Chil.,
- 17 1. Helen Ruthven, b. Jan. 6, 1841. 2. Robert, b. May, 1845, d. 1847.
- ☞ Besides those seven, 4 other children d. in childhood.

p. 404. **PHILBRICK.**—The homestall or residence of THOMAS PHILBRICK, in Wat., was at the N. W. corner of what are now called Belmont and Lexington Streets. It has not been ascertained when he arrived in the country; but it is probable that he was of that company that came over in 1630. It is probable also that most, if not all, of his children were born in England. Thomas, supposed to be his second son, was b. in 1624, and his dr. Elizabeth was married before 1643. His Will, dated 1663, mentions the following five children. [See General Reg. vii., p. 358.]

1. *James*, a mariner, m. *Ann* —.

2. *Thomas*, b. 1624 (æt. 42, d. in 1666); m., Sept. 22, 1669, *Hannah*, wid. of John White, [See [3] p. 886.] Perhaps this m. was that of his son. Edward

* John Morton, Esq., of New York, the father of Mrs. Quincy, married Sophia Maria Kemper, whose father emigrated from the Rhine, and settled in New York. Her brother, Col. Kemper, of the Revolutionary Army, who died a few years ago, in Elizabethtown, New Jersey, was father of Rev. Jackson Kemper, for many years an assistant of the venerable Bishop White, of Philadelphia, now Bishop of Missouri. Susan Kemper, a sister of Mrs. Morton, and of Col. Kemper, m. Dr. David Jackson, of Philadelphia, and was the mother of Dr. Samuel Jackson, the distinguished professor in the University of Pennsylvania.

French, of Hampton, an aged man, in his Will, dated 1673, mentions his daughter Philbrick. [Geneal. Reg. vi., 254.]

3. *Elizabeth*, m. (1st), previous to 1643, *Thomas Chase*, of Hampton, by whom she had 5 sons (see the text, p. 404).
4. *Hannah*. 5. *Martha*, m. *John Cass*, of Hampton.

Ephraim Philbrick m. Elizabeth Barron, and had three chil. b. in Groton, 1687, 90 and 99. [Butler, p. 426.] Elizabeth Philbrick m., in Groton, Feb. 16, 1683, Samuel Willard, of Killingby, Conn.

- p. 405. **PHILPOT.**—It is probable that there was only one person of the name of Philpot in Watertown, viz., Thomas, and that John is a misnomer. Thomas Philpot, proprietor of a homestead in 1642, became insane as early as 1647, and was imprisoned, the usual treatment of that malady at that time. He was living as late as 1678.

- p. 406. **PIERSON.**—The residence of Bartholomew Pierson, in Watertown, which he purchased of John Stowers, in 1644, was on the N. side of Belmont Street, between Thomas Philbrick on the east, and Anthony Pierce on the west. Oct. 7, 1655, he sold his house, barn, and about 6 acres, to Anthony Pierce, for £23; bounded W. by (?) John Pierce. The land he sold to George Bullard, for £12 (8 acres, not 12), was bounded N. by John Wincol; E. by Isaac Stearns; W. by Anthony Pierce; S. by highway. After he moved to Woburn, he had a dr. Sarah, b. May 7, 1653. It was probably his dr. Mary (birth not recorded), who m., in Woburn, Oct. 28, 1673, John Richardson. His son Bartholomew, d. Feb. 23, 1661. He (E.) d. in Woburn, Mar. 12, 1687, and his wid. Ursula, d. May 28, 1694.

PORTER.—Roger Porter was selectman of Wat., 1648. After he came to Watertown, he m. Grace, wid. of William Palmer, first of Watertown, afterwards of Newbury, of Piscataqua (Portsmouth), and Hampton. [See Palmer, p. 865.] It has not been ascertained what became of his four daughters, whom he brought with him from England.

- p. 407. **POTTER.**—Ap. 15, 1635, William Potter, aged 25, embarked for New England, in the *Increase*, Robert Lea, master. July 1, 1635, William Potter, husbandman, aged 27, Frances Potter, uxor, aged 26, and Joseph Potter, aged 20 months, embarked for New England, in the *Abigail*, &c. Except for the difference of age, it might be supposed that the two were identical, as cases occurred, where names were entered for one vessel, and the persons came in another. If there were two persons of that name, it is not known which of them settled in Watertown, but probably the one aged 25. June 2, 1646 (the year after Wm. Potter sold his land in Wat.), William Potter, m., in Rox., Judith Greaves. [See Drake's Hist. of Boston, p. 248.] Was it his wid. Judith Potter, who m. Samuel Finch, in Rox., Dec. 13, 1654? William Potter was one of the signers of the original agreement entered into by the first settlers of New Haven. [See Hinman's Catalogue, 2d ed., p. 76.]

PRATT.—For adm. freeman, read, took the oath of fidelity. It is probable that Thomas Pratt came from London. [See Boylston, p. 702.]

PRENTICE.—Ruth Worthylake, wife of Benjamin Prentice, came from New London to Wat., in Aug., 1763. Prentice occupied the Learned Tavern in 1766–70.

PRESCOTT.—John Prescott took the oath of fidelity in 1652, and was adm. freeman, May 19, 1669. He d. 1683. [For much information respecting his life, character, parentage, family, and very numerous and highly respected descendants, see Geneal. Reg. vi., 274; Willard's History of Lancaster, in Worcester Mag. vol. II., and his Centennial Address in Lancaster, June 15, 1853; Butler, pp. 285, 428, and 476; Shattuck, p. 381; also see p. 828.] He owned 6 lots of land in Watertown, amounting to 126 acres.

- p. 407. **PRICE.**—It will be seen, p. 408, that a query was entertained as to the identity of families of the name of Price and Priest. Several circumstances had formerly ren-

dered this very probable, and it is now satisfactorily ascertained that they were identical. In the Town Record, Nov. 28, 1670, the name of Wm. Price, is written Priest. Oct. 23, 1697, Mary, relict of William Price, for £90, sold to Samuel Livermore, a house and 14 acres, bounded E. and N. by Camb. line; W. by Philpot's lot, and Henry Godden; S. by William Shattuck, and town land common. To this deed is attached the following memorandum. "Whereas, ye grantor's name in this deed is called Priest, which name she is commonly known by, yet it is here to be understood that her right name is Price." William Price (her son), signed a quitclaim to this property, to Samuel Livermore. A little before this, viz., May 1, 1695, wid. Mary Price, and her son William, sold to Wm. Shattuck, 14 acres in the same neighborhood. Her death is not recorded in Wat., and it is probable that, about the time of these sales, she left the town to reside with one of her children. At a trial in court, between parties belonging to Watertown, "Wm. Priest" was a witness. His age is not given. It is not improbable that he came over in his youth, with John Wetherill, his kinsman. [See Wetherill, p. 637.]

Of William Price, Jr., the latest notice discovered, is his signing a quitclaim to the mother's homestead, as above stated.

Of John Price (ex'r of his father, Wm., Sen.), no precise information has been obtained; but it is conjectured that he settled in Lancaster. After the death of his father he was lessee of the Philpot lot, in Dec., 1686, and July, 1688. Perhaps he is the one, who m. Rachel, dr. of Samuel Garfield [Garfield 2]-5]. In a deed for land in Weston, sold 1710, it is described as bounded N. and W. by John Priest and James Priest. [John Priest, of Woburn, had, 1. Elizabeth, b. Sept. 12, 1679. 2. John, b. Nov. 1, 1681. 3. Hannah, b. July 19, 1686. Nothing more has been learned respecting this family; but the dates show that the father could not have been the John Price (Priest), born in Watertown.]

For James and Joseph, sons of William Price, see Priest, 1 and 11, p. 408.

Hannah Price, the youngest child, m. Dec. 24, 1702, Thomas Sanderson [5].

Sept. 3, 1751, caution against (settlement of) Hannah Price, from Boston.

PRINCE.—John Prince, the progenitor of the families of this name in New England, settled first in Watertown, afterwards successively of Hingham and Hull; m. for his 2d wife Anne, wid. of William Barstow. [See General. Reg. V., 383, and Barstow, in Part II., p. 678.]

p. 409. **PROUT.**—Ebenezer Prout was Clerk of the House of Representatives, in 1689, and on the 6th June, signed the order of the House for the imprisonment of Sir E. Andros, in the Castle. His eldest son Timothy, by his first wife, Elizabeth [Brooks, 43, p. 721], married Lydia, daughter of Major Thomas Savage, of Boston. In 1728, he purchased the Cammock Patent, at Black Point (in Scarborough), of the heirs of Capt. Joshua Scotlow, and settled there, and d. Ap. 5, 1768. His children, b. between 1718 and 1728, were, 1. Lydia. 2. Ebenezer, of Scarboro. 3. Timothy, of Boston. 4. Joseph, of Scarborough. 5. Mary, m. Capt. Alexander Kirkwood, a Scotchman, of Scarboro, s. p. 6. Elizabeth. [See Hist. of Scarboro, p. 221.]

QUINER.—Thomas Quiner and family, moved to Cambridge, in June, 1741.

RAINSBOROUGH. (Rainborow, Rainburrow, Rainsborow.)—Dec. 17, 1640, William Rainsborow purchased of Thomas Bright, for £60, the house and land in Wat., which had been the homestall of Lieut. Robert Feakes. He was elected a member of the An. and Hon. Art. Co., in 1639, probably early in that year. Whether he resided in Watertown, has not been ascertained; but such a purchase renders it probable. He returned to England in 1644; became Colonel of a Regiment in Cromwell's army, of which Israel Stoughton was Lt. Col.; Nehemiah Bourne, Major; John Leverett, a Captain; and William Hudson, his Ensign. [Winthrop, II., p. 245.] He was Governor of Worcester in 1646, and he went to Ireland in 1647. He d. 1648. [See Clarendon's Hist. Rebellion, 3219.] Did Col. Stephen Winthrop marry his sister? [Winthrop, II., pp. 351, 354; also Colonial Records, II., pp. 60, 80, and 82.]

- p. 410. **RANDALL**—[6.] For Kendall, read Kemball. Serj. John Randall, m. Susanna Kemball. [Kemball, 1½.] He bought of James Cutler and wife Mary, 6 A., sometime in the possession of Nicholas Theall.
 [7.] Susanna Randall m. Enoch Sawtel. [7.]
 [10.] (?) Feb. 10, 1697-8, Mary Randall (? wid.), sold land to her brother-in-law, Enoch Sawtel, weaver.
 [17.] Stephen Randall m. (3d), Mar. 29, 1753, Mary Manning. [See 15, p. 528.]
 [19.] Mary Randall, an orphan, grandchild of wid. Worth, bap. in Wat., June 26, 1698.

RAYNOR.—Thurston Raynor, had a lot of 330 acres in Wethersfield, which he sold to Robert Treat, and moved to Stamford in 1641. [See Oldham, p. 864.] He was elected magistrate in May, 1664. Perhaps this was the son, who was then 49, and the father 70 years old.

RAYNGER.—Caution by Lex., against (settlement of) Ann Raynger, from Wat., May, 1761. July 10, 1694, Mrs. Hooper warned not to entertain Henry Reiner.

REMINGTON.—John Remington was selectman, 1771, 72, 77, and lived in the house previously occupied by Capt. David Baldwin.

REYNOLDS.—Robert and John Reynolds, were both very early settlers of Watertown. Robert was adm. freeman Sept. 3, 1634, and was dismissed from Wat. Church, May, 1635, in order, with others, to organize a church on Connecticut River. John was adm. freeman May 6, 1635, and about the same time (in 1635), he was appointed on a committee in Wat., for dividing to every man, his share of meadow and upland. There is no further notice of either of them in the town records. They probably both belonged to the colony that first went from Watertown to Wethersfield. John Reynolds was one of the original purchasers of Stamford, and a John Renold was a freeman and "townsman" of Norwich, in 1669. As the name of Robert Reynolds does not occur, after a very early date, in the Conn. Col. Records, it is conjectured that he returned to the Bay Colony; that two of his daughters, Ruth (Whitney), and Mary (Sanger), settled in Watertown, where he had first settled, and that he d. in Boston, in 1659. [See his Will, in General. Reg. ix., p. 137; also Whitney [10], and Sanger [1].]

-
- [p. 411. **RHODES**.—Theophilus Roads was one of the appraisers of the estate of Capt. John Sherman, in Feb. 1690-1. In the list of rates, Mar. 20, 1690-1, was "Mr. Roads and the fulling-mill." Theophilus Rhodes was adm., 2d church, Boston, 1682-3.

RICHARDSON.—[2.] George Richardson, aged 30, embarked at London, in the Susan Ellen, Ap., 1635. [4-9.] For May 8, read Aug. 8; and after Wellington, insert [61]. See [37, p. 800.]

-
- p. 412. **RIDER**.—Ap., 1685, Thomas Rider, of Wat., refused to pay his rates. June 4, 1690, suit in court, Capt. Andrew Belcher, vs. Thomas Rider, of Wat., for withholding the corn-mill, verdict for the plaintiff. July 17, 1691, Thomas Rider, of Wat., for £22 10s., mortgaged to Phillip Shattuck, of Wat., weaver, 30 A. of dividend land, also all his right in a grist-mill, on said land, bounded N. by Camb. line; S. by land of Elizabeth Wood; W. by Mary Sherman; E. by Christopher Grant. Thomas Rider and wife Sarah, resided in Dorchester, in 1709.

ROBBINS.—Mar. 3, 1704, Richard Robbins, of Wat., mortgaged lands in Wat. to Richard Brattle. [See Jonathan Livermore, p. 853.]

ROBERTS.—George Roberts, aged about 15 years, was wit. in Court, 1678. Joseph Roberts, Rep. of Weston, 1778.

ROBINSON.—George Robinson was one of the original or very early members of Weston Church. Sarah, wife of George Robinson, d. 4 months after marriage (? stated in Court, June, 1685).

[2.] Admin. on estate of William Robinson granted to son William, Oct. 21, 1695. Inventory, dated Aug. 14, 1695, £43 17s. The nuncupative Will of William Robinson, dated Mar. 22, (?) 1693-4, mentions son William, of Newton. May 16, 1698, Samuel and Nathaniel Sparhawk appointed guardians of Samuel Robinson, aged 18, and of Jonathan Robinson, aged 16 yrs. David Robinson, a cripple, was a town charge between 1690 and 1700.

- p. 412. **ROGERS.**—[1.] Thomas Rogers left a wid. Grace, who m. William Palmer, and afterwards Roger Porter, and a dr. Elizabeth, who m. Daniel Smith [200]. [See Colonial Record IV., p. 232, and see Palmer, p. 865.]
- p. 413. [3.] Priscilla Dawes, now wife of John Rogers, was dismissed from the first Church in Boston to Wat., Nov. 22, 1640.
- [5.] For Grant [15], insert Grout, q. v. The Will of Daniel Rogers, potter, of Wat., dated Nov. 1, 1711, proved Feb. 18, 1711-12, appoints his wife and his father-in-law, Edward Harrington, exrs. Inventory, Nov. 20, 1711; house and land, £100; total, £175 18s. [See Harrington, [53], p. 275, and Grout, p. 777.]

ROOK.—For 1646, read 1746. Aug. 28, 1744, caution against (settlement of) Honora Rook, from Boston, 3d May last.

ROSE.—Embarked at Ipswich, Eng., Ap. 1634, in the Francis, John Cutting, Master, ROBERT ROSE, aged 40, wife MARGERY, aged 40, and chil., 1. *John*, aged 15 yrs. 2. *Robert*, aged 15. 3. *Elizabeth*, aged 13. 4. *Mary*, aged 11. 5. *Samuel*, aged 9. 6. *Sarah*, aged 7. 7. *Daniel*, aged 3, and *Dorcas*, aged 2 yrs. It is not clearly ascertained that this family settled in Watertown; but it is very probable, as they came over in the same ship with several other Watertown families, and belonged to the colony that went thence to plant Wethersfield. Robert Rose was sworn constable of Wethersfield Feb. 6, 1639-40. In the Naubuc Farms, he had an allotment of 312 acres. Robert Rose was one of the freemen of Stratford, in 1669.

RUCK.—Thomas Ruck, of Charlestown in 1638, adm. freeman May, 1640, soon afterwards of Salem. In the list of the possessions of Isaac Sterne, made out in 1642-44, is one lot of 10 acres, bought of Thomas Ruck, Nov. 2, 1643 (by him purchased of Capt. Jennison), and another lot of 60, also bought of him. Oct. 17, 1643, the General Court allowed Mr. Ruck £5 15s., "for the charge of the Committee which met at Salem." Although an early proprietor, it is probable that he never resided in Watertown.

RUSSELL.—Mar. 13, 1738-9, caution against (settlement of) wid. Russell and son, from Boston, Nov. 1738.

[2.] For Hepzibah, read Mehitabel.

John Russell and wife Elizabeth, o. c., and dr. Mary bap. by Mr. Angier, Ap. 6, 1712.

SAFFORD.—Thomas Safford, of Wat., belonged to Capt. Jonathan Brown's Company at Lake George in 1758.

- p. 414. **SALTMARSH.**—Thomas Saltmarsh [1], was a sea-captain, born in England. He m. (1st), Mary, dr. of Richard and Mary (Peabody) Hazen, of Boxford, and settled in Charlestown, where his eldest two children, Mary, was bap. June 6, 1731, and Elizabeth, bap. June 10, 1733. About 1734, he moved to Wat., where he was constable in 1743, and Assessor 1741, 42, and 45. He m. (2d), in 1769, ANNE, wid. of Abijah Stone, and dr. of John Jones, of Fram. [See Barry, p. 306; also, Livermore, 60½, p. 341.]

[2.] William Saltmarsh was a Lieut. under Capt. Jona. Brown, at Lake George, in 1758.

- p. 415. [30.] THOMAS SALTMARSH, Jr., m., in 1759, BETSEY ABBOTT, b. Aug. 25, 1743, dr. of Edward and Dorcas Chandler Abbott, of Concord, N. H. He d. 1826, and she d. 1827. Chil.,
1. *Mehitabel*, b. 1762, d. 1814; m., 1784, *James Hoit*.
 2. *Sally*.
 3. *Betsey*.
 4. *Eliphalet*.
 5. *Thomas*, b. 1774; of Guilford, N. H.; m. *Catherine Abbot*.
 6. *Peaslee*, m.
 7. *Elnathan*. [See Reg. of Abbotts, pp. 101-2.]

[37 and 38.] See [1.] above.

SALTONSTALL.—Sir RICHARD SALTONSTALL, of Huntwicke, b. 1586, was a son of Samuel Saltonstall, of Rookes and Huntwicke, by his first wife, ANN, daughter of John Ramsden, of Longley, Esq., and a grandson of Gilbert Saltonstall, who purchased Rookes in Hipperholme. He was a Justice of the Peace for the West Riding of Yorkshire, and Lord of the Manor of Ledsham, near Leeds, which he purchased of the Harebreds. He was not one of the six who purchased Massachusetts Bay of the Plymouth Company, Mar. 19, 1627–8, but he soon became one of their associates. After Sir Henry Rosewell and Sir John Young, two of the original purchasers, he is the next named among those associates, in the Charter granted by Charles I., Mar. 4, 1628–9; and he is the first named among those Assistants appointed by that Charter. The first time his name appears in the records of the Courts of the Massachusetts Bay Company, was Mar. 5, 1628–9, where it immediately succeeds the names of the officers; and it will be found, in those records, that his name almost invariably stands at the head of the Assistants. When the proposition of Gov. Cradock, to transfer the government of the Company from England to the Colony, was to be argued in a General Court of the Company, on the 29th of Aug., 1629, Sir Richard was named first of those who were designated to advocate the transfer. At a General Court, held Oct. 15, 1629, two committees were appointed, one on the part of the adventurers, who were to remain in England, and the other on the part of those to go over, in order to draw up articles of agreement “between the adventurers here at home, and the planters that are to go over, as well for arranging and settling the joint stock, as for reconciling any difference that may happen upon this change [transfer] of government.” Sir Richard was appointed chairman of the committee on the part of the emigrant adventurers. At a General Court, held Sept. 29, 1629, “were read the orders made the 28th and 29th of August last, concerning the transferring of the patent and government of the plantation into New England, but that business, being of great and weighty consequences, is thought fit to be deferred for determination until Sir Richard Saltonstall, Mr. Johnson, and other gentlemen, be come up to London, and may be here present.” It is probable that his residence continued to be in Yorkshire until about the time he went to America, and for that reason he was not a constant attendant at the Courts of the Company. At a General Court, held Dec. 1, 1629, in order to fulfil those articles of agreement, the Company appointed five “undertakers” among those about to go over, of whom Sir Richard was named next after the Governor, and five others among those that were to remain in England.

Early in April, 1630, Sir Richard, with his sons and daughters, embarked at Yarmouth, on board the *Arabella*, and arrived at Salem on the 12th of June. Those passengers, by this and other ships, who landed at Salem, very soon proceeded to Charlestown, where their number was much enlarged by the arrival of passengers in other ships, that came directly to Charlestown. Here this company was very soon divided into two portions. One of them, with Sir Richard as their leader, and Mr. Phillips as their minister, went to plant Watertown, and without delay (July 28), organized a church, and Sir Richard was the first subscriber to the church covenant. The other portion of the Company, with Gov. Winthrop as their leader, and Mr. Wilson as their minister, remained in Charlestown, and organized a church, which was soon afterwards transferred to Boston. [See Historical Introduction.]

Sir Richard remained in America less than a year. On the 29th of March, 1631, he, with his two daughters, and one of his younger sons, embarked for England, and, it is said, fixed his residence in London, having sold his estate in Yorkshire about the time he became one of the adventurers in the Massachusetts Bay Company. He never returned to America; yet we may presume that he proposed, and was expected to return, as he was elected an Assistant by the General Court in May, 1633. He continued to be a proprietor of Watertown for several years. Mar. 3, 1635–6, the Court granted him 100 acres of meadow in Watertown, and in the allotment of Beaver Brook plowlands, 1636, 30 acres were assigned to him, among “the townsmen then inhabiting.” This assignment was made because his estate in Watertown was managed by his servants, in his name, for whom he was responsible; and this probably continued only until his sons, Samuel and Henry, attained to their majority. In the list of possessions ordered to be made in 1642, Sir Richard’s name does not appear, but the names of those two sons.

He, with Viscount Say and Seal, Lord Brooke, and others, was one of the patentees of Connecticut, and he was active in promoting its settlement. For this purpose, he sent over a bark of 40 tons, with 20 servants, which arrived at Boston, June 16, 1635. His interest in the Connecticut plantation did not, however, seem to diminish his regard for Massachusetts Bay. This was evinced by his efficient superintendence of

its interests in England, by the settlement of three of his sons, and the education of the other, in Massachusetts, and by his legacy to Harvard College.

Among those who subscribed the two letters, dated London, Aug. 29, 1629, one of them addressed to Gov. Endicott, and the other to the ministers of Salem, and likewise that letter dated on board the Arbella, Ap. 7, 1630, addressed to their Christian friends and brethren they were about leaving in England, the name of Sir Richard Saltonstall stands first. In addition to this circumstance, there is in them so much Christian charity, such a courteous tone, a spirit so liberal for that day, and so much in harmony with his admirable letter, addressed to the ministers of Boston a few years afterwards, that we may fairly conjecture, if not confidently assert, that he was the author of all of them. Of that letter of expostulation and rebuke to the ministers of Boston,* above referred to, Dr. Francis justly says, "this letter is a noble testimony to his charitable and Christian feelings, and seems to me scarcely less to deserve the praise of being beyond the age, than the celebrated farewell address of John Robinson, at Leyden." A character in all points so exemplary, so good, and so great, so exempt from any seeming blemish or defect, it is not easy to find among the early worthies of New England; and his honorable descent, and the superior social position, so evidently conceded to him by the other adventurers, are feeble claims to our respect, compared with his eminent personal worth.

After he returned to England, he received marked tokens of the public confidence. His influence at court is shown by his success in thwarting the machinations of the enemies of Massachusetts Bay. In 1644, he was Ambassador to Holland, and while there, his portrait was painted by the celebrated Rembrandt. It is now in the possession of the family of the late Hon. Leverett Saltonstall, and it is very highly valued as a work of art. Upon it is this inscription, "Aet. suæ 58, A. D. 1644." In 1649, he was one of the High Court of Justice appointed to try Duke Hamilton, Lord Capel, the Earl of Holland, the Earl of Norwich, and Sir John Owea, for high treason, of whom the first three were condemned and executed, and the other two were condemned, but pardoned.

SIR RICHARD SALTONSTALL, m. (1st), GRACE KAYE, daughter of Robert Kaye, of Woodsome, Esq., and aunt of John Kaye, Bart. She was the mother of all his children. She d. before he went to Massachusetts Bay. After his return to England, it is said he m. (2d), a daughter of Lord Delaware, and m. (3d), MARTHA WILFORD. The date of his decease has not been ascertained, but his Will was made in 1658, at the age of 72. Chil.,

the most assured friend
Rec: Saltonstall

* Copy of a Letter from Sir Richard Saltonstall to Mr. Cotton and Mr. Wilson.

"Reverend and dear friends, whom I unfeignedly love and respect,
 "It doth not a little grieve my spirit to heare what sad things are reported dayly of your tyranny and persecutions in New England, as that you fine, whip, and imprison men for their consciences. First, you compell such to come into your assemblies as you know will not joyne with you in your worship, and when they show their dislike thereof, or witness against it, then you styrre up your magistrates to punish them for such (as you conceive) their publicke affronts. Truly, friends, this your practice of compelling any in matters of worship to doe that whereof they are not fully persuaded, is to make them sin, for soe the Apostle (Rom. 14 and 23), tells us, and many are made hypocrites thereby, conforming in their outward man for feare of punishment. We pray for you, and wish you prosperitie every way, hoping the Lord would have given you so much light and love there, that you might have been eyes to God's people here, and not to practice those courses in a wilderness which you went so farre to prevent. These rigid wayes have layed you very lowe in the hearts of the saynts. I doe assure you I have heard them pray in the publicke assemblies that the Lord would give you meeke and humble spirits, not to strive so much for uniformity as to keepe the unity of the spirit in the bond of peace.

"When I was in Holland, about the beginning of our warres, I remember some Christians there, that then had serious thoughts of planting in New England, desired me to write to the governor thereof to know if those that differ from you in opinion, yet holding the same foundation in religion, as Anabaptists, Seekers, Antinomians, and the like, might be permitted to live among you, to which I received this short answer from your then Governour, Mr. Dudley. God forbid (said he) our love for the truth should be growne soe cold that we should tolerate errors; and when (for satisfaction of myself and others) I desired to know your grounds, he referred me to the books written here between the Presbyterians and Independents, which if that had been sufficient, I needed not have sent so farre to understand the reasons of your practice. I hope you doe not assume to yourselves infallibility of judgment, when the most learded of the Apostles confesseth he knew but in parte and saw but darkly as through a glass, for God is light, and no further than he doth illumine us can we see, be our pastes and learning never so great. Oh that all those who are brethren, though yet they cannot thinke and speake the same things, might be of one accord in the Lord. Now the God of patience and consolation grant you to be thus mynded towards one another, after the example of Jesus Christ our blessed Saviour, in whose everlasting armes of protection hee leaves you who will never leave to be

Your truly and much affectionate friend
 in the nearest union,
 RIC. SALTONSTALL.

"For my reverend and worthy much-esteemed friends, Mr. Cotton and Mr. Wilson, preachers to the church which is at Boston, in New England, give this.

9. 2 1. RICHARD, b. at Woodsome, Co. York, in 1610; d. at Hulme, Co. of Lancaster, Ap. 29, 1694, aged 84.
- 2 2. ROBERT, was probably the 2d son of Sir Richard, as he must have attained his majority at least as early as 1636; for on the 23d Sept., 1637, Mr. Hugh Peters presented to the Court a deed, by which Robert Saltonstall assigned to him all the estate that he hath or shall have, to satisfy his creditors. This implies that he had some time before attained his majority. It appears by a deed dated about 1642, that he had resided some time in Watertown, and he probably went to reside in Boston, as early as 1638 or 40; and was adm. mem. An. and Hon. Art. Co., 1638. He was the superintendent of his father's interest in this country, and it appears by the Colonial Records, that in 1645, Sir Richard had granted to him irrevocably, all his dues or claims in this country, which was allowed by the Court. His name often occurs in the Colonial Records, in connection with business transactions. June 2, 1641, it was certified to the Court, that Connecticut colony had sold to Mr. Robert Saltonstall, "a great quantity of land, not far below Springfield." June 20, 1645, for £100, he sold to his brother Richard, 2100 acres of land on Connecticut River, "between Springfield and Windsor Ferry." [Essex Deeds, I., p. 7.] He was one of those purchasers of the two patents of Wecohannet (Dover), and Pascataquack (Portsmouth), who, on the 14th of June, 1641, "gave up and set over," all their power of jurisdiction to the government of Massachusetts Bay. Oct. 1, 1645, the Court granted to him 3200 acres, in right of his father, which had been granted to Sir Richard, as an adventurer. Previous to May 26, 1647, he had sold to Adam and Dean Winthrop, 1000 acres at Cochituit, which had been granted to his father, to be laid out by Capt. Pelham and Mr. Pendleton. There were repeated contests between him (as agent of his father) and Watertown, respecting titles to lands. They were finally terminated by arbitration in Oct., 1647. May 29, 1644, he was fined 5s. for presenting a petition, respecting land in Watertown, on so small and so bad a piece of paper. Mar. 16, 1647-8, having sold a house and land, to which he had no just and true right, and about which there had been considerable controversy, he was ordered by the Court to make restitution, was fined for his miscarriage, to pay costs of Court, and was *debarred from pleading in other men's causes in any Court of Justice*, except himself have real interest therein. This renders it probable that he was a lawyer, or had been accustomed to act as an advocate in courts of justice. May 2, 1649, he petitioned for a new trial in the above-mentioned case, which was granted. In Oct., 1648, and again in Oct., 1649, the Court permitted him to prosecute and recover, in any court of justice, his legal claims in the two patents of Swamscote (Exeter), and Dover on Pascataqua River. He was never admitted freeman, probably because he was not disposed to conform to the rigid discipline of a Puritan church. He was enterprising and energetic, and his father seems to have reposed entire confidence in his integrity; yet he seems not to have possessed the public spirit, and the high-toned religious and moral characteristics, which were so admirably illustrated in his father and his brother Richard. He d. unm. about July, 1650.
- His Will, dated June 13, proved Aug. 15, 1650, mentions his father; his brothers, Richard, Samuel, and Henry; his sisters, Rosamond and Grace; his uncle John Clarke, whom, with George Munnings, he appointed executors; his aunt Clarke, and her son, then in Barbadoes. He made bequests also to Henry Walton, Adam Winthrop, and Thomas Lake. On the day the Will was proved, John Clarke renounced the executorship. [See General Reg. vii., 334.] It is supposed that Martha, wife of John Clarke, of Boston, was a sister of Sir Richard; but it seems to me more probable that their wives, Grace and Martha, were sisters.
- 4 3. SAMUEL, probably the 3d son of Sir Richard, is mentioned in the Will of his brother Robert, and in a letter of his sister Rosamond, dated Ap. 22, 1644. For an account of him, see pp. 415-16, and note, p. 918.
- 5 4. HENRY, probably the youngest son. [See p. 415.] No additional information respecting him has been obtained. He is mentioned in the Will of his brother Robert, and in the letter of his sister Rosamond.
- 6 5. ROSAMOND, perhaps the eldest child. In Ap., 1644, she had been living two

- years at Warwick House, in the family of the Earl of Warwick. Whether she ever married, or what became of her, has not been ascertained.*
- 7 6. GRACE, mentioned by name, in her brother Robert's Will, and in her sister's letter (but not named) and then, 1644, living in the family of Lady Manchester. It is not known whether she married, or what became of her.
- 8 [7. Peter Saltonstall, was formerly conjectured to be a son of Sir Richard; but it is now deemed nearly certain that he was not. His name has been discovered in no records, except those of the Artillery Company. He is not mentioned in the Will of Robert, which mentions all the other children of Sir Richard, nor in the letter of Rosamond to her brother Samuel, which was probably written some time before he was elected into the Art. Co.; as he was, with one exception, the last one elected in the year 1644. It is not improbable that he was a son of Sir Peter Saltonstall, of Berkway, Co. Herts, Kt., a first cousin of Sir Richard. Sir Peter had a son Peter, who d. s. p.]

- 2.9 (II.) RICHARD SALTONSTALL, Jr., eldest son of Sir Richard, b. at Woodsome, Co., York, in 1610; matriculated "Mr. Fellow-commoner," in Emmanuel College, Camb., Dec. 14, 1627. He accompanied his father to New England, in 1630, before taking a degree; was adm. freeman, May 18, 1631, then of Wat., aged 21, with the title "Mr." This was only a few weeks after his father departed for England. He embarked for England Nov. 23, 1631, where he remained about four years and a half, and, it is conjectured, gave some attention

* There is, in the Archives of the Am. Antiquarian Society at Worcester, an autograph letter of hers, so warm with sisterly affection, and so imbued with an earnest Christian spirit,—so creditable to her mind as well as her heart—that it seems worthy of insertion.

"April 22, 1644.
"From Warwick House.

"Dear Brother:—

"I am not a little glad to receive any intimation of your health and happiness, either by word or writing, and both your own letter and my brother Henry's intelligence, hath lately assured me of it. I should be much more glad to see you that I might know you better, and enjoy more intimate acquaintance with your spirit, especially in spiritual things. I trust you have seen and heard so much the beauty thereof, where you are, that they have really challenged your heart from all the world. I can desire nothing so much as your soul's prosperity, and that you would interest yourself in all the ways and means, that might add to your growth for an eternal welfare. I am sure 'tis the best counsel, and you will find it so one day, when all your days on earth must be concluded by death. Consider that time much, and what kind of provision eternally will require, and then the world and all carnal things will not take up your thoughts more than needs must.

"Dear Brother, I am glad to hear of you so well as I do, and therefore, I desire you would go farther, and not be a hindrance to the good of your own soul by any indisposition of nature. Put forth yourself and trust God in his own way and work, if you can find, in any true measure, anything of Christ savingly wrought in you; and what he will own, man dares not reject, nor any that desire to draw near to God in any ordinance; and all his ordinances are precious and highly to be valued, and surely God will never draw so near, or delight in any, that do not make it their desire and endeavor to draw near to him in every ordinance. Consider your condition seriously, put yourself to trial, let God see you willing to deny yourself in all carnal reasonings and sinful objections, that you may give up yourself fully to be one of Christ's flock, that he may wholly rule over you.

"Dear Brother, you are likely to be a constant settler where you are; therefore, without question, you have liberty to dispose of yourself into church-fellowship, and I pray God you may be so fitted for it, as interested in it.

"For our condition here, I need not tell you how we are dispersed; my father and brother Henry, are in Holland. My father hath some necessity to be there now, because of Mr. White's breaking, by whom my father hath lost more of that little estate he hath left. For the present I am, and have been, two years in my Lord of Warwick's family; my sister is with my Lady Manchester, and thus we are dispersed about. The Lord give us all a gathering in Christ, and there we shall meet without separation to all eternity.

"Dear Brother, farewell, only remember me, and I shall never [forget] you, * * * * *

"Your truly affectionate

*Sister Rosamond
Saltonstall*

*For my Deare Brother
Mr Samuel Saltonstall
at Water towne in
New england give
these*

to legal studies. About 1633, he married MERIELL GURDON, dr. of Brampton Gurdon, of Asson, Co. Suffolk, Esq. (who, it is said, had "eight sons, Parliament men"). He embarked at London, in Ap., 1635, with wife Meriell, aged 22 yrs., and dr. Meriell, aged 9 months. Upon his arrival, then aged 25, he settled in Ipswich, and immediately began to receive tokens of public respect and confidence; and there is not probably in the early colonial history, another instance, where so young a man received so many. The Colonial Records show that he was truly a worthy son of a very worthy father.

Mr. Saltonstall was elected Deputy of Ipswich, to the first General Court, held after his return, and was at five courts between Mar. 3, 1635-6, and April, 1637. He was elected Assistant, June 1, 1637, and continued to be elected annually until 1649. In Oct. of that year, another man was appointed in his place on a commission, which he could not attend to, "in regard of his intended voyage," bound to England, probably for the benefit of his wife's health. Sept., 1649, "being, by God's Providence, upon a voyage to England," he appoints the present Pastor and the Deacons of the Church of Ipswich, his attorneys, with "power to act," about all of his estates in Ipswich. [Essex Deeds, II., p. 6.] When he returned has not been ascertained, but he was in England in the spring of 1662. [See Hutchinson's State Papers, p. 371.] In 1672, he went back to England, where his three daughters were married. He returned to Massachusetts again in 1680, where he remained about three years; and then, at the age of 73, went again to England, where he died, at Hulme, Ap. 29, 1694, aged 84. He was elected Assistant, in 1664, and again, upon his second return to Ipswich, in 1680, 81, and 82. Sept. 6, 1636, the Court appointed a committee to examine the accounts of Mr. R. Saltonstall, executor of the estate of John Dillingham, deceased, and of Edward Dillingham, his son. This estate was not finally settled until 1645. May 25, 1636, he, with two others, was appointed "to keep court" at Ipswich. In 1644, 1646, and 1647, he was appointed ("desired") to keep court" at Piscataqua. Sept. 8, 1636, he was one of those deputed to require the last rates of each town in the plantation; to find out the true value of every town in the plantation, and to make an equal rate for £600. The next year he received a similar appointment. In 1638, he was appointed a referee "in business, between Henry Sewall and the town of Newbury." Mar. 12, 1637-8, he was one of the committee appointed to report upon "excessive prices," and to report "their thoughts for remedying the same." At the same time he was appointed on a committee "to consider of a levy, petitions, and other trivial matters." May 29, 1644, he, with two others, was appointed, "with full power to hear and determine all businesses at Hampton, both about their differences, offences, and a new plantation, according to their several petitions."

Oct. 7, 1641, he was, by the Court, appointed him Serjeant Major in Col. Endicott's Regiment. Although he received so many offices and appointments, and the preceding are only a part) he does not seem to have been ambitious for office. Winthrop says, that in 1644, Mr. Saltonstall "moved very earnestly that he might be left out of the next election (of Assistants), and pursued his motion after to the towns;" and he supposes that it was because Mr. S. found himself in a small minority, among the Assistants, on some points of public policy. Like his father, he had more correct views of public justice, and of civil and religious liberty, than were then and there prevalent. Oct. 1, 1645, the Court granted a charter, for 20 years, after any discovery made within three years, to the following gentlemen, as a trading company or company of adventurers, viz., "Richard Saltonstall, Esq., Mr. Syman Bradstreet, Mr. Samuel Symonds, Mr. Richard Dumer, Mr. Willie Hubbard, Capt. Wm. Hathorne, and Mr. Wm. Paine." He was one of those persons who were privy to the concealment of the regicide Judges, Whalley and Goffe, and in 1672, he gave them £50.

There are three events in the life of Mr. Saltonstall, of some importance, as illustrative of his regard for civil liberty, public justice, and humanity.

The greatest blemish, the charge which it is most difficult to meet satisfactorily, in the conduct of the planters of Massachusetts Bay, is undoubtedly their bigoted attachment to the minutia of their religious dogmas, their seeming to be the disciples of Moses more than of Christ, their intolerance of any variation from their views, even on speculative points of no practical importance, and the severity of their dealings with those who conscientiously differed from them. In such a condition of the

public sentiments, or rather of those who bear rule, there can hardly fail to be a proneness towards the assumption of arbitrary power. This was manifested in the early attempt of the Court to tax the people without their consent, which, however, was so met by the Rev. George Phillips, the uncompromising Elder Richard Browne, and other people of Watertown, that it was not afterwards attempted. This occurred while Mr. Saltonstall was in England. The next important manifestation of this tendency was on the 3d of March, 1635-6, when the Court passed an order, that the General Court, at their next meeting, "shall elect a certain number of magistrates for term of their lives, as a standing council." This order was obnoxious to the people, and awakened among them a jealousy of the designs of their rulers. They looked upon it as an infringement of their rights, as an attempt to introduce into the government an almost irresponsible body, which was not warranted by their charter. Such was the excitement produced, that at the end of three years (May 22, 1639), the Court virtually, but not formally, almost annulled the force of that order. The obnoxious Standing Council, however, still subsisted, and to allay the excitement, the Court authorized "every freeman to give their advice to any of the deputies concerning the institution and power of the Standing Council."

Mr. Saltonstall, although an Assistant, with a very fair prospect of becoming a member of that Council, if he desired it, coincided in sentiment with those freemen, and such of the Elders as disapproved of the Standing Council, differing in this respect from most of the other Assistants; and he wrote a book, maintaining that the institution of such a body for life was not warranted by the Charter, and was a sinful innovation. It is evident, from Winthrop, that his remarks were cogent and pointed. Mr. Saltonstall put the book into the hands of Mr. Hathorne, a Deputy, and from him it passed into other hands, and not until after the lapse of a considerable time was it laid before the Court. The book gave great offence, especially to some of the high officials, those most interested in the institution which was attacked, and they would gladly have censured or otherwise punished the author. But such was the character and influence of Mr. Saltonstall, and so cogent and unanswerable his argument, that they did not succeed, and he was "discharged from any censure or further inquiry by this or any other court." This vote was passed May 3, 1642. Yet so much ranking did the book leave in certain persons interested, that on the 14th of the next month, the Court voted "to vindicate the office of the Standing Council, as it is now ordered, and the persons in whom it is now vested, from all dishonor and reproach, cast upon it or them, in Mr. Saltonstall's book." For this purpose, the book was referred to the Elders, the very persons who had advised the institution of such a Council. "The Elders all met at Ipswich," Oct. 18, 1642, and took the book into consideration. They "differed much in their judgment about it," but finally agreed to report that three propositions are laid down in it, and "in their answer they allowed the said propositions are sound;" but they made some nice distinctions about the application of them, intended to lessen the odium attached to the institution and the authors of it. The Government of Massachusetts Bay, through their own weakness, and the artifice of La Tour, became dishonorably, not to say dishonestly, implicated in "the French business,"—the controversy between D'Aulney and La Tour. In an early stage of this business (in May, 1643), "those about Ipswich, &c., took great offence at these proceedings," protesting against them "with divers arguments, some whereof were weighty." [Winthrop, II., 128; Hutchinson's State Papers, p. 115.] In this protest, it is fair to presume that Mr. Saltonstall was the leader, not only from his social and official position, his being the first subscriber, and his known sentiments, but from his subsequent conduct.

This protest, dated July 14, 1643, was signed by Richard Saltonstall, Simon Bradstreet, Samuel Simonds, Nath. Warde, Ez. Rogers, Nath. Rogers, John Norton. [See Hazard's State Papers, I., p. 502.] Mr. Bradstreet speaks of it as a joint production,—"we writ the letter," "our letter," and he defended it against the strictures of Gov. Winthrop.

At the General Court, in May, 1645, a commission was granted to the Governor (Dudley), Lieut. Atherton, Mr. Pelham, Capt. Cooke, Mr. Saltonstall, and Mr. Hathorne, with power to summon witnesses, &c., to search out the truth about "the French business;" yet, at the same Court, a pass was granted to La Tour for seven armed vessels; and a small amount of provision was allowed them "on the country charge." This was a manifest violation of the spirit, if not of the letter, of the 9th Article of the Confederation of the four New England Colonies, entered into in May, 1643; and in August, 1645, a solemn and formal protest was delivered to the Commissioners of

the United Colonies, in the handwriting of Mr. Saltonstall, and signed by himself and Mr. Hathorne, who were a minority of those commissioners of inquiry, appointed the preceding May. This protest, for pertinence, perspicuity, just sentiments, and comprehensive views, will compare most favorably with any state paper of that period. [See Winthrop II., pp. 381-3.] From this paper, we may infer the ability displayed in Mr. Saltonstall's book against a Standing Council for life.

Mr. Saltonstall is entitled to a high place among those Christian philanthropists, who have entertained a conscientious regard for "the higher law," and have spoken and acted promptly and boldly against the nefarious slave trade. Capt. James Smith, of Boston, and his mate, Thomas Kaezar, in the ship *Rainbow*, went to the coast of "Guinea to trade for negroes." Upon their return, bringing only two negroes to Boston, and reporting their doings, Mr. Saltonstall, in Oct. 1645, presented to the General Court a petition, representing in strong terms the heinous conduct of Smith and Kaezar, declaring that "the act of stealing negroes, or taking them by force (whether it be considered a theft or a robbery), is (as I conceive) contrary to the law of God and the law of this country," and he "requested that the several offenders may be imprisoned by the order of this Court, and brought to their deserved censure in convenient time." The petition, written with Mr. Saltonstall's peculiar terseness, perspicuity, and boldness, was signed by himself only. [Winthrop, II., p. 379.] The petition was granted, and it was ordered that Capt. Smith (a member of Boston Church), and Mr. Kaezar, "be laid hold on, and committed to give answer." The Court ordered the two negroes to be delivered up, and one, if not both of them, to be sent back to Guinea at the public expense.

Yours most faithfully in all Christian
affairs.
Richard Saltonstall.

Children of RICHARD, Jr., and MERIELL SALTONSTALL. [Neither the dates nor the order of their births (except that of Meriell) have been ascertained.]

- 10 1. MERIELL, b. in Eng., in July, 1634; m. Sir EDWARD MOSELEY, of Hulme, Co. Lancaster, Kt. 1 child.
 1. Anne, m. Sir John Bland, of Kippax Park, Bart.
 - 11 2. NATHANIEL, b. in Ipswich; grad. Harv. Coll. 1659.
 - 12 3. RICHARD, d. s. p.
 - 13 4. ABIGAIL, m. THOMAS HARLEY, of Hinsham Court, Co. Hereford, younger son of Sir Robert Harley, whose elder son, Sir Edward Harley, was father of Robert Harley, Earl of Oxford.
 - 14 5. ELIZABETH, m. HERCULES HORSLEY, Esq., and had a dr. Meriell, mentioned in the Will of her uncle, Col. Nathaniel S.
-
11. 15 (III.) Col. NATHANIEL SALTONSTALL, son of Richard Saltonstall, Jr., Esq., of Ipswich, m., Dec. 28, 1663, ELIZABETH WARD, b. Ap. 9, 1647, dr. of Rev. John and Alice (Edmunds) Ward, of Haverhill, where he settled. [Rev. John Ward, b. Nov. 5, 1606, was a son of Rev. Nathaniel Ward, of Ipswich, the author of "The Simple Cobler, of Agawam," and a grandson of Rev. John Ward, a minister of Haverhill, Eng.] Aug. 29, 1664, Richard Saltonstall, of Ipswich, conveys by deed to his son Nathaniel, now of Haverhill, 800 acres on his marriage with Elizabeth Ward. [Essex Deeds, II., 208.] He d. May 21, 1707, and his wid. Elizabeth d. Ap. 29, 1707. His Will, dated May 19, 1707, made a bequest to his niece, Meriell Horsley; mentions his sister, Elizabeth Horsley, and his "rents in Killingly," Eng. Col. Saltonstall was town clerk of Haverhill from 1668 to 1700, 32 years. He was chosen Assistant from 1679 to 1686, when the charter of

Massachusetts Bay was taken away, and when he was named one of "the Council of the Governor of Massachusetts Bay," under Sir Edmund Andros. But he refused to accept the appointment, and, upon the deposition of Sir Edmund, he became one of the Council, which took the government of the Colony into their hands. He continued in this office until the arrival of the Charter of William and Mary, wherein he was appointed one of their Majesty's Council. On the 2d June, 1692, he was appointed one of the Judges in a special commission of Oyer and Terminer, for the trial of persons accused of witchcraft, and, with a highminded liberality, worthy of his father and grandfather, the more honorable for being at that time singular, he, and he alone, refused to serve in that commission from conscientious scruples. In August, 1680, he went with the Deputy Governor and others, "with 60 soldiers, in a ship and sloop from Boston, to still the people at Casco Bay, and prevent Gov. Andros's usurpation." In 1683, he was appointed by the Crown one of the Commissioners "to examine and inquire into the claims and titles, as well of his Majesty as others, to the Narragansett country," to which important commission he attended. He was administrator of the estate of his uncle, Samuel Saltonstall, of Watertown. Chil.

Wash: Saltonstall

51. 16 1. GURDON, b. Mar. 27, 1666, grad. Harv. Coll. 1684, d. Sept. 20, 1724.
- 17 2. ELIZABETH, b. Sept. 17, 1668; m. (1st), Rev. JOHN DENNISON, grad. Harv. Coll. 1684, d. 1689, leaving one child, John. She m. (2d), 1690, Rev. ROLAND COTTON, b. Dec. 27, 1667 [son of Rev. John, Jr., and Joanna (Rossiter) Cotton, of Plymouth], grad. Harv. Coll. 1685, ordained in Sandwich, Nov. 2, 1694, d. Mar. 22, 1721-2. His wid. Elizabeth d. in Boston, July 8, 1726. Chil.,
- 18 1. John (Dennison), grad. Harv. Coll. 1710; Librarian of Harv. Coll. 1713-14; studied Divinity, and preached one year, but was never ordained; afterwards settled in Ipswich, as a lawyer, and attained the rank of Colonel. He m., Ap. 9, 1719, *Mary Leverett*, b. Oct. 29, 1701, dr. of Hon. John Leverett, Pres. of Harv. Coll. and his wife Margaret (Rogers). He d. Nov. 25, 1724, leaving a wid., one son, and one dr. His wid., Mary, m., Dec. 25, 1728, Rev. Nathaniel Rogers, b. Mar. 4, 1701-2, son of Rev. John and Martha (Whittingham) Rogers; grad. Harv. Coll. 1721, ordained in Ipswich, Oct. 18, 1727. She d. at Ipswich, June 27, 1756, and he d. May 10, 1775.
- (By 2d husband, Rev. R. Cotton.)
- 19 2. John (Cotton), b. July 15, 1693, grad. Harv. Coll. 1710, ordained in Newton, Nov. 3, 1714; m., Feb. 9, 1719, *Mary*, dr. of Robert Gibbs, of Boston. He d. May 25, 1757. [See Jackson, pp. 251-2.] Chil.,
- 20 1. Mary, b. Dec. 7, 1719; m., May, 1746, Rev. Thomas Cheney, of Brookfield.
- 21 2. Elizabeth, b. Jan. 21, 1722; m., Oct. 1750, Jno. Hastings, Jr., Esq., of Camb., grad. H. C. 1730, d. 1783.
- 22 3. Anna, b. Oct. 9, 1723; m., 1742, Rev. Samuel Cook, of Menotomy.
- 23 4. Rebecca, b. Nov. 3, 1725; m., Mar. 1762, Capt. Samuel Baldwin, of Weston, q. v. p. 11.
- 24 5. Martha, b. Sept. 28, 1727, d. soon.
- 24 6. John, b. Dec. 22, 1729, grad. Harv. Coll. 1747; a physician; m., July 8, 1750, *Mary Clark*, d. 1758, a. p.
- 25 7. Nathaniel, b. July 6, 1731, grad. Harv. Coll. 1750, d. 1771.
- 26 8. Samuel Gibbs, b. Feb. 7, 1734, d. 1734.
- 26 9. Henry, b. Oct. 28, 1735, d. 1736.
- 27 10. Samuel, b. Jan. 24, 1738; grad. Harv. Coll. 1759, d. 1819.
- 27 11. Martha, b. Nov. 30, 1739; m., Oct. 1766, Rev. Ebenezer Thayer, of Cambridge.
- 28 3. Nathaniel, b. 1694; grad. Harv. Coll., 1717, ordained at Bristol, Aug. 30, 1721; d. July 3, 1729, æt. 36.
- 29 4. Sarah.
- 30 5. *Abigail*, m., in 1725, Rev. *Shearjashub Bourne*, grad. Harv. Coll., 1720; ordained at Scituate, Dec., 1724; d. 1768. She d. in 1732, and he m., in 1738, Sarah Brooks, of Medford. [Brooks 91, p. 723.]
- 31 6. Meriell, b. about 1698.

- 32 7. *Roland*, grad. Harv. Coll., 1719; m. *Deborah Mason*, Oct. 3, 1760.
- 33 8. *Josiah*, grad. Harv. Coll., 1722; ordained at Providence, R. I., Oct. 23, 1728; installed at Woburn, July 15, 1747; and at Sandown, N. H., Nov. 28, 1759; d. May 27, 1780, aged about 77.
- 34 9. *Ward*, grad. Harv. Coll., 1729; ord. Hampton, N. H., dism. 1765; d. at Plymouth, Nov. 27, 1768, aged 57.
- 35 10. *Joanna*, m. Rev. *John Brown*,* of Haverhill, b. in Camb. (Brighton), 1696; grad. Harv. Coll., 1714; ordained in Haverhill, May 3, 1719; d. Dec. 2, 1742, aged 46, "greatly esteemed for his learning, piety, and prudence." Chil.,
- 36 1. *John*, grad. Harv. Coll., 1741; minister, of Cohasset, 45 yrs.; d. 1792, æt. 67.
- 37 2. *Cotton*, grad. Harv. Coll., 1743; ordained in Brookline, Oct. 26, 1748; d. Ap. 13, 1751.
- 38 3. *Ward*, grad. Harv. Coll., 1748; d. same year.
- 39 4. *Thomas*, grad. Harv. Coll., 1752; ordained first in Marshfield, afterwards, in 1765, installed at Stroudwater, in Falmouth, Me. He d. there, 1797.
- 40 5. *Abigail*, m. Rev. *Edward Brooks*. [Brooks, 163, p. 726.]
- 41 6. *Mary*, m. *Samuel Gray*, of Medford. She d. 1839, aged 73.
- 42 7. *Joanna Cotton*, m. *Nathaniel Hall*, of Medford; d. 1841, aged 69.
- 43 3. *RICHARD*, b. Ap. 25, 1672; grad. Harv. Coll., 1695; was a Colonel; m., Mar. 25, 1702, *MEHITABEL*, dr. of Capt. *Simon* and *Sarah Wainwright*, (?) of Haverhill, and granddr. of *Francis* and *Phillis Wainwright*, of Ipswich. He d. Ap. 22, 1714, and admin. was granted to his nephew, *John Dennison* [18], June 28, 1714, and same day Rev. *Rowland Cotton*, his brother-in-law, was appointed guardian of his children.
119. 46 1. *Richard*, b. June 14, 1703; grad. Harv. Coll., 1722.
2. *Ward*, b. May 21, 1705; d. Aug. 5, 1706.
- 47 3. *Nathaniel*, b. June 3, 1706; was a merchant, d. young; grad. Harv. Coll., 1727.
- 48 4. *Elizabeth*, b. June 25, 1707.
- 49 4. *NATHANIEL*, b. Sept. 5, 1674; grad. Harv. Coll., 1695; Tutor, Librarian, 1697—
- * 1 *THOMAS BROWN*, of Camb., m., Oct. 7, 1666, *MARTHA* (Sherman) *OLDHAM*, wid. of *Richard Oldham*, of Camb. [By her first husband, she had two sons, *Samuel* and *John Oldham*.] He probably resided in that part afterwards called Little Cambridge, now Brighton. He d. about the close of 1690. Inventory taken Jan., 1690-1. His Will, dated Nov. 23, 1690, mentions wife *Martha*, and chil., *Mehitabel*, *Martha*, *Ebenezer*, and *Ichabod*. [See Will of *Richard Sherman*, p. 430.] Chil.,
1. *MARY*, b. Ap. 23, 1668, d. soon.
2. *MEHITABEL*, b. May 13, bap. June 2, 1661; living in 1690.
3. *MARY*, b. Nov. 1, bap. Nov. 3, 1663; not mentioned in her father's Will.
4. *EBENEZER*, b. June 16, bap. July 23, 1663; m. *MARY* —. He d. in Newton, Mar. 3, 1739-40, and his wid. *Mary*, d. Mar. 5, 1742-3. We have not obtained a record of his family, but it is probable that he was the father of *Thomas*, of Newton, who by wife *Abigail*, had 9 children; of *Abraham*, of Newton, who m. *Abigail Dyke*, in 1780; of *Jonathan*, of Newton, who by wife *Hannah*, had 9 children; of *Robert*, of Newton, who m., Mar. 27, 1728, *Mary Fowle*, and had 9 children. [See *Jackson's Hist. Newton*, p. 248.]
5. *ICHABOD*, b. Sept. 6, bap. Sept. 9, 1666; of Camb. (Brighton); m. (1st), May 31, 1693, *MARTHA WOODBURY*, of Beverly. He m. (2d), Jan. 12, 1708, *MARGARET ODLIN*, of Boston. [See Bright, 10.] His Will, dated 1726, son *John*, exec'r, mentions the following children.
- 6 1. *John*, grad. Harv. Coll., 1714; of Haverhill. [Saltonstall, 36.]
- 7 2. *Martha*, m., Jan. 4, 1727-8, *William Pessenden* (his 2d wife). 4 chil. [See *Locke Family*, pp. 314 and 315.]
- 8 3. *Frisilla*, m., Sept. 24, 1724, *Noah Sparhawk*, b. about Feb., 1696-7, son of *Dea. Nathaniel* and *Abigail* (Gates) *Sparhawk*, of Camb. [grandson of *Nathaniel* and *Patience* (Newman) *Sparhawk*, and gr. grandson of *Dea. Nathaniel Sparhawk*, an early settler of Camb., from England. See *Farmer*.] He d. Feb. 4, 1748-9. She d. about 1766. Chil.,
- 9 1. *Frisilla*, b. Aug. 6, 1725; d. before 1765; m., Oct. 3, 1745, *Abraham Cutting*. [50.]
- 10 2. *Nathaniel*, b. Oct. 3, 1727. 3. *Noah*, b. Oct. 19, 1729; of Rutland, in 1765.
- 12 4. *Martha*, b. Jan. 2, 1731-2; m., Nov. 20, 1760, *John Hancock, Jr.*, of Charlestown.
- 13 5. *Nathan*, bap. July 23, 1734; of Rutland, 1765.
- 14 6. *Ebenezer*, b. June 16, 1738. [See p. 544.]
- 15 7. *George*, bap. Sept. 20, 1741; d. Jan. 27, 1757.
- 16 4. *Sarah*, m., Dec. 27, 1726, *Samuel Belcher*, son of *Richard* and *Mary Belcher*, of Charlestown. He was a tailor, came to Camb., about 1722, and moved thence to Wrentham, about 1743. Chil.,
- 17 1. *Samuel*, b. Dec. 5, 1727. 2. *Sarah*, b. Oct. 13, 1729.
- 19 3. *Mary*, b. Mar. 21, 1731-2. 4. *Martha*, b. Mar. 22, 1733-4.
- 21 5. *Abigail*, b. Dec. 6, 1735. 6. *Elizabeth*, b. Aug. 3, 1738.
- 23 7. *Andrew*, b. Sept. 10, 1740.
- 24 5. *Abigail*, not married in Jan., 1728-9, when she signed a quitclaim deed of her father's estate.
- 26 6. *MARTHA*, b. Oct. 19, 1668; m., Jan. 3, 1689, *SAMUEL PARKER*.

*who was the heir of
his father*

1701; d. early. In 1738, DOROTHY, wid. of Nathaniel Saltonstall, left a legacy of £300 to Harv. College. Harv. Catalogue, says he d. 1739, probably an error.
5. JOHN, b. Aug. 14, 1678; d. Oct. 2, 1681.

16. 51 (IV.) Gov. GURDON SALTONSTALL, grad. Harv. Coll., 1684; received a unanimous call in May, 1688, to settle in New London, where he was ordained Nov. 19, 1691. Upon the death of Gov. John Winthrop, who d. Nov. 27, 1707, Mr. Saltonstall was elected his successor, and took the oath of office as Governor of Connecticut, Jan. 1, 1708. He was tall and well proportioned, of dignified aspect and demeanor; of eminent intellectual endowments and acquirements, and a very graceful and impressive elocution. He was an advocate of vigorous ecclesiastical authority, always striving to exalt the ministerial office, to maintain its dignity, and to enlarge the powers of ecclesiastical bodies; which gave him unbounded popularity among his clerical brethren. Such were his views of law and order, both in church and state, and of the discipline to be employed in maintaining them, and such his regard for official dignity and privileges, that he acquired the reputation of being severe, imperious, and of seeking self-aggrandizement. Yet he was a very popular Governor, and remained in office until Sept. 21, 1724, when he died suddenly of apoplexy. [For a full and excellent delineation of his character, see Caulkin's Hist. of New London.] He m. (1st) JERUSHA RICHARDS, dr. of James Richards, of Hartford. She d. in Boston, July 25, 1697. He m. (2d) ELIZABETH ROSEWELL, dr. and sole heir of William Rosewell,* of Branford. She d. in childbed in New London, Sept. 12, 1710. He m. (3d) Mrs. MARY CLARKE, dr. of William and Mary (Lawrence) Whittingham, and relict of William Clarke, of Boston. She d. in Boston, Jan. 23, 1730, s. p. [For her parentage and lineage, see Farmer; also Riker's Annals of Newtown, L. I.] To his son Rosewell, he bequeathed the Rosewell estate in Branford, and his manor of Killingly, near Pontefract, in Yorkshire, England; to his son Nathaniel, his farm at Cauchinchang (Durham); to his son Gurdon, his lands in New London; to his daughters Elizabeth, Mary, and Sarah, the estate in Wethersfield, that was their mother's. He also provides for his daughter Catherine. He built a mansion on the border of Lake Saltonstall, in Branford, which has a variety of antique ornaments;—walls hung with grotesque pictures, Spanish leather tapestry, &c. &c.

G. Saltonstall.

(Chil. by 1st wife, Jerusha.)

- 52 1. ELIZABETH, b. May 11, 1690; m. (1st), Aug. 4, 1710, RICHARD CHRISTOPHERS, b. Aug. 18, 1685, son of Richard and Lucretia (Bradley) Christophers, of New London. He d. June 9, 1726, and she m. (2d) ISAAC LEDYARD, merchant, of New London. Chil.,
- 53 1. Richard (Christophers), b. July 29, 1712; d. Sept. 28, 1736; m., 1734, Mary, dr. of John Pickett. Chil., 1. Mary, b. May 23, 1734. 2. Elizabeth, b. Dec. 24, 1735; m. Capt. Joseph Hurlbut, and d. Mar. 11, 1798.
- 54 2. Elizabeth, b. Sept. 13, 1714. 3. Mary, b. Dec. 17, 1716.
4. Sarah, b. Dec. 6, 1719. 5. Joseph, b. Nov. 30, 1722.

* WILLIAM ROSEWELL, b. in 1680; m. (by Increase Nowell, Esq.), in Charlestown, Nov. 20, 1684, CATHERINE RUSSELL, dr. of Hon. Richard and Maud Russell, of Charlestown. [See note, p. 736.] In 1688, wood and common land was assigned to him "on Mistick syde," in Charlestown. He moved to Connecticut, as early as 1667. He probably first went to Branford, as he was one of the original signers of the "New Plantation Covenant" of Branford, Jan. 20, 1667; but he must have moved to New Haven very soon afterwards, for on Jan. 13, 1667, the town of New Haven granted him a lot, on which he built a house, and "for some years dwelt in;" was engaged in trade, and owned a bark trading between New Haven and Barbadoes. He probably returned to Branford, in 1671; for, on the 9th of Feb., 1671, the town of Branford granted him a tract of land, at the outlet of the Lake [since called Saltonstall Lake], on condition of his erecting and maintaining a dam there. This dam yet remains. In the same year was a marriage settlement between Hon. Richard Russell, and his daughter Catherine Rosewell, of the one part, and Mr. William Rosewell, of the other part, settling upon her heirs of this marriage, first male and second female, the farm by the Lake, with the negroes (naming them), Albert and his wife Ruth, and chil. Caty, Andrew, and Ruth, and another negro named Peter. He d. July 19, 1694, aged 64, intestate. Inventory, 1st, estate in Branford; 2d, 200 acres of land in Durham, purchased of Mr. Wyllys, for £24 silver, and £119 gold; 3d, a gold ring; 4, a great still and worm. Total £476. His wid. Catherine, d. 1698. Inventory, Nov., 1698, and Elizabeth is mentioned as her "only child." Chil,

1. MAUD, b. Aug. 20, d. Sept., 1686, in New Haven.

2. WILLIAM, b. in N. H., June 16, 1670; d. young, but was living at the date of his grandfather Russell's Will, Mar. 29, 1674.

3. ELIZABETH, b. in Branford, Oct. 1, 1679; m. Gov. G. SALTONSTALL.

6. *Catherins*, b. Jan. 5, 1724-5.
- 59 2. MARY, b. Feb. 15, 1691-2; m., Mar. 2, 1717-18, JEREMIAH MILLER, of New London; grad. Yale Coll., 1709; d. 1761.
- 60 3. SARAH, b. Ap. 8, 1694; m. (1st) JOHN GARDNER; m. (2d) SAMUEL DAVIS; m. (3d) THOMAS DAVIS, all of New London.
4. JERUSHA, b. July 5, d. Sept. 12, 1695.
5. GURDON, b. 17, d. 27, July, 1696.
(By 2d wife, Elizabeth.)
65. 61 6. ROSEWELL, b. Jan. 19, 1701-2, grad. Harv. Coll. 1720.
- 62 7. KATHERINE, b. June 19, 1704; m. THOMAS BRATTLE, of Boston.
- 63 8. NATHANIEL, b. July 1, 1707; m., in 1733, LUCRETIA ARNOLD, and settled in one of the Southern Colonies.
70. 64 9. GURDON, b. Dec. 22, 1708, grad. Yale Coll. 1725.
10. RICHARD, b. 1st, d. 12th, Sept. 1710.
-
61. 65 (V.) Capt. ROSEWELL SALTONSTALL, Esq., settled in Branford, Conn., on the estate inherited from his maternal grandfather, William Rosewell. The beautiful Saltonstall Lake, on the west side of Branford, was probably named for him. He m. Mrs. MARY LORD, dr. of Hon. John Haynes, grad. Harv. Coll. 1689, d. 1713, and wid. of Elisha Lord. She was a granddr. of Rev. Joseph Haynes, grad. Harv. Coll. 1658, of Wethersfield, 1663, afterwards of Hartford, by wife Sarah, dr. of Richard Lord, and gr. dr. of Thomas Lord, one of the first settlers of Hartford. She was a gr. granddr. of Gov. John Haynes. He died at New London, while there on a visit, Oct. 1, 1738, and was buried in the tomb of his father. His wid. m., Feb. 5, 1741, Rev. Thomas Clapp, minister of Windham, Conn., afterwards President of Yale Coll. Chil.,
-
- 66 1. MARY, m. NATHAN WHITING, of New Haven, (?) grad. Yale Coll. 1743, d. 1771.
- 67 2. SARAH, m. JONATHAN FITCH, of New Haven, (?) grad. Yale Coll. 1748, d. 1793.
- 68 3. CATHARINE, m. JONATHAN WELLES, Esq., of Glastenbury, Conn., (?) grad. Yale Coll. 1751, d. 1792.
- 69 4. ROSEWELL, b. in 1736; grad. Yale Coll. 1751, d. in Branford, Jan. 25, 1788, unm. When he left College, a "conservator" (guardian) was placed over him, and he continued under guardianship until his decease.
-
64. 70 (V.) GENERAL GURDON SALTONSTALL, of New London, grad. Yale Coll. 1725, was distinguished for activity in mercantile and military affairs. He long held the rank of Colonel, and attained the rank of Brig. General in the Revolutionary Army previous to 1776. He was the first Collector of the Port of New London, in 1784. He m., Mar. 15, 1732-3, REBECCA, dr. of Hon. John and — (Dudley) Winthrop, and granddr. of Hon. Waitstill and Mary (Browne) Winthrop. He d. Sept. 19, 1785. Chil.,
-
- 71 1. GURDON, b. Dec. 15, 1733, grad. Yale Coll. 1752; d. in the Island of Jamaica, W. I., July 18, 1762, unm.
- 72 2. REBECCA, b. Dec. 31, 1734; m. DAVID MUMFORD, of New London, afterwards of New York.
- 73 3. CATHARINE, b. Feb. 17, 1735-6; m. JOHN RICHARDS, of N. London.
- 74 4. WINTHROP, b. June 10, 1737, grad. Yale Coll. 1756; Register of the Court of Admiralty; m., Ap. 17, 1763, ANN, eldest daughter of Hon. Joseph Wanton, of Newport, R. I. She d. in 1784, and he d. in July, 1811, in New London, where he always resided. Chil.,
- 75 1. Rebecca, b. Mar. 4, 1764; m. Peter Christophers, of N. London.
- 76 2. Gurdon, b. July 3, 1765. He was largely engaged in mercantile pursuits. He m. Hannah Sage, b. Jan. 28, 1769, dr. of Comfort Sage, of Middletown, Conn. He d. at St. Nicholas Mole, Island of St. Domingo, June 9, 1795. She lived in widowhood 58 years, and d. in Chicago, Ill., Jan. 28, 1853, aged 84. Chil.,
- 77 1. Mary H., bap. Ap. 13, 1791; m., July 21, 1812, Rev. Daniel Huntington, late of Bridgewater, Mass., now (1854), of New London, Conn.
- 78 2. William W., b. Ap. 19, 1793; m., 1826, Mary, dr. of Richard W. Parkin, of New London. In 1836, he moved from N. London to Chicago, where he now (1854), resides. Chil., 1. Gurdon W. 2.

- Francis G. 3. Mary P., m. William Woodward, of N. York. 4. William W. 5. Edward H. 6. Thomas L.
- 79
81 3. *Mary Wanton*, b. Mar. 14, 1767; m., Nov. 29, 1789, Dr. *Thomas Coit*, of New London, b. Ap. 1767, son of Thomas, Jr., and Mary (Gardner) Coit. [See Hinman, pp. 643 and 644.] Chil.,
- †82 1. *Anna W.*, b. Sept. 11, 1790, d. Aug. 30, 1794.
2. *Mary Gardner*, b. Ap. 28, 1792.
3. *Hannah Saltonstall*, b. June 18, 1795, d. Aug. 23, 1796.
4. *Augusta Dudley*, b. Mar. 31, 1797, d. 1822.
5. *Martha*, b. Mar. 13, d. Mar. 17, 1802.
- †83 6. *Thomas Winthrop*, b. June 28, 1803, grad. Yale Coll. 1821; D.D. Columb. Coll.; Pres. Trans. Univ., and now (1854), Prof. Eccl. Hist. in Trin. Coll., and Lecturer on Chemistry and Natural Science; m. *Eleanor Forester*.
- †84 7. *Elizabeth Richards*, b. May 25, 1806; d. Feb. 25, 1837; m. *EDWARD Coit*, of Norwich.
- †85 8. *Gurdon Saltonstall*, b. Oct. 28, 1808; m. *Eleanor F. Carlisle*.
- 82 4. *Ann Dudley*, b. Jan. 8, 1770, d. May 21, 1845, unm.
- 83 5. *Winthrop*, b. Feb. 10, 1775; grad. Yale Coll. 1793; M.D. Columb. Coll., N. Y.; a physician, of Trinidad, where he d., June 27, 1802, unm.
- 84 5. *DUDLEY*, b. Sept. 8, 1738, a distinguished seaman, of New London. In early life, he made numerous voyages in mercantile pursuits. In the Revolutionary War, he attained the rank of Commodore, and had command of the American Fleet in the expedition against Penobscot in 1779. The disastrous issue of that expedition was attributed to unforeseen obstacles, and the insufficiency of the force,—not to any want of skill or bravery in the Commander. The largest American vessel was the *Warren*, of 32 guns, and they were attacked by a squadron of five British war vessels, led on by Sir George Collier, in the *Rainbow*, of 44 guns. Under such circumstances, the destruction or capture of the American Fleet was inevitable. He afterwards commanded the privateer *Minerva*, and among the prizes taken by him was the *Hannah*, a merchant ship, of London, bound for N. York, having the most valuable cargo sent to America during the war. The exasperation produced by this and other losses by privateers from New London, is said to have led to that expedition, in Sept. 1781, in which New London and Groton were burnt, and the garrison of Fort Griswold massacred. Capt. D. Saltonstall m., in 1765, *FRANCES*, dr. of Dr. *Joshua Babcock*, of Westerly, R. I. She d. in New London, Oct. 1787, and he d. in the West Indies in 1796. After his decease, his family moved from New London to Canandaigua, New York. Chil.,
- 85 1. *Hannah*, b. 1767; m. *Joseph Walley*, a native of England, who settled in Canandaigua, N. Y.
- 86 2. *Frances*, b. 1769.
- 87 3. *Dudley*, b. 1771, grad. Yale Coll. 1791, settled in the South.
- 88 4. *Thomas Brattle*, b. 1772, d. in W. Indies, in 1795, unm.
- 89 5. *Catherine*. 6. *Martha*. 7. *Joshua*.
- 92 6. *ANN*, b. Feb. 29, 1739—40; m. *THOMAS MUMFORD*, of Norwich, Conn.,
- 93 7. *ROSEWELL*, b. Aug. 29, 1741; m., Mar. 4, 1763, *ELIZABETH*, dr. of *Mathew Stewart*, of N. London. He moved, late in life, to New York, where he d., Jan. 12, 1804, and his wid. *Elizabeth* d. in 1817. They were buried in Trinity churchyard. Chil.,
- 94 1. *Elizabeth*, b. about 1765, d. at an advanced age, unm.
- 95 2. *Richard R.*, b. in 1768; an able merchant, d. of yellow fever, in Sept. 1798, unm.
- 96 3. *Rosewell*, an eccentric character, well known in the latter years of his life in the streets of New York; d. in 1840.
- 97 4. *Abigail*, m. Dr. *William Handy*, of Newport, afterwards of N. York.
- 98 5. *Ann*, m. Rev. *Charles Seabury*, of St. James's Ch., N. London; afterwards Rector of Carolina Church at Setauket, L. I., where he d. in Ap., 1845.
- 99 6. *Hannah*, d. unm., in Sept. 1805.
- 100 7. *William*, m. *Maria Hudson*, an English lady. He d. at Pensacola, Aug. 26, 1842, leaving 3 chil.,
- 101 1. *William*, of Chicago. 2. *Susan*, m. — Beare, of Meriden, Conn.
3. *Henry*, of Meriden.

- 104 8. *Matthew Stuart*, d. early. 9. *Mary*, m. *John Fell*, Esq., of New York.
 105 10. *Francis Walter*, d. in N. Y., unm. 11. *Frances*.
 107 8. ELIZABETH, b. Jan. 12, 1742-3; m. (1st), JOHN EBBETS, or EVARTS. She m.
 (2d), SILAS DEAN, U. S. Commissioner to France during the Revolutionary War.
 108 9. MARY, b. Mar. 28, 1744; m. JEREMIAH ATWATER, of New Haven, many years
 steward of Yale College.
 109 10. RICHARD, b. Jan. 1, 1746-7, d. unm.
 110 11. MARTHA, b. Oct. 8, 1748; m. DAVID MANWARING, first of New London, after-
 wards of New York.
 111 12. HENRIETTA, b. Mar. 19, 1749-50; m. JOHN MILLER, of New Haven.
 112 13. GILBERT, b. Feb. 27, 1751-2; (?) grad. Harv. Coll. 1770; a captain of marines
 on board the ship Trumbull, in her desperate combat with the *Watt*; m. HARRIET
 BARCOCK. He d. about 1800, leaving two sons, and his wid. m., in Ap. 1805,
 Marvin Wait, Esq., of New London.
 113 1. *Gurdon*, professor of mathematics in the Univ. of Alabama, where he d. s. p.
 114 2. *Gilbert*, b. in 1791; m., July 3, 1814, *Elizabeth*, dr. of J. Starr, of New
 London. He d. at Tuscaloosa, Ala., Feb. 6, 1833, aged 42. Chil.,
 115 1. Harriet B. 2. Gilbert D., a physician, of N. York city; m., May 13,
 1854, Sarah, dr. of John Marseilles. 3. Gurdon.
 118 14. SARAH, b. June 17, 1754; m., Dec. 3, 1775, DANIEL BUCK, of Wethersfield,
 Conn., b. June 13, 1744, son of Josiah and Ann (Deming) Buck, grandson of
 David and Elizabeth (Hubbert*) Buck, and great grandson of Emanuel and
 Mary, of Wethersfield. He d. June 6, 1808, and his wid. Sarah d. Nov. 19,
 1828. [See Hinman, pp. 365 and 66.] Chil.,
 1. *Anna*, b. and d. 1776. 2. *Gurdon*, b. Dec. 30, 1777.
 3. *Daniel*, b. Oct. 27, 1779. 4. *Charles*, b. Mar. 21, 1782.
 5. *Winthrop*, b. Dec. 9, 1784. 6. *Ann*, b. Oct. 12, 1786, d. 1788.
 7. *Dudley*, b. June 25, 1789.

46. 119 (V.) Hon. RICHARD SALTONSTALL, of Haverhill, grad. Harv. Coll. 1722; re-
 ceived the commission of Colonel at the age of 23, and was appointed Judge of
 the Superior Court in 1736, at the age of 33. He "was a man of talents and
 learning; was distinguished for generous and elegant hospitality, and for his boun-
 tiful liberality to the poor. His address was polished, affable, and winning, his
 temper was gentle and benevolent, and he enjoyed the love and esteem of all."
 He m. (1st), Jan. 6, 1726, ABIGAIL WALDRON, b. 1702, dr. of Richard. She
 d. Mar. 16, 1735. He m. (2d), Mar. 4, 1740, MARY JEKIL, of Boston, s. p. He
 m. (3d), MARY COOKE, dr. of Elisha Cooke, Jr., Esq., of Boston, by wife Jane,
 dr. of Richard Middlecott, Esq., of Boston, who m. in 1672, a gr. daughter of Gov.
 Edward Winslow. She was a granddr.
 of Elisha Cooke, Sen., Esq., a physician,
 of Boston, who m. Elizabeth, dr. of Gov.
 John Leverett. He d. Oct. 20, 1756.
 Chil.

Richard Saltonstall

- 120 1. ABIGAIL, b. Oct. 5, 1728; m. Col. GEORGE WATSON, of Plymouth, s. p. [See
 Sabine's American Loyalists.]
 2. ELIZABETH, b. June 5, 1730, d. Oct. 19, 1737.
 121 3. RICHARD, b. Ap. 5, 1732, grad. Harv. Coll. 1751; was a distinguished scholar,
 and had the Latin Oration when he graduated. He was the fourth of the family
 in succession who held the office of Colonel. In the rank of Major, he was
 engaged in active service in the French War on Lake George, and belonged to
 that body which capitulated at Fort William Henry, Aug. 9, 1757. When the
 Indians fell upon the unarmed prisoners, he fled to the woods, and very
 narrowly escaped death in that horrid massacre. He commanded a regiment
 from 1760 until the end of the war. Soon after this, he was appointed High
 Sheriff of the county of Essex.

Col. Saltonstall was a firm loyalist, and uniformly opposed the measures taken
 in opposition to the royal government. He deemed the proceedings of the

* This Elizabeth "Hubbert" was probably a dr. of Daniel Hubbard, of Guilford, and a granddr. of George
 Hubbard, first of Wethersfield, afterwards of Guilford. [See Hubbard, p. 796.]

British Parliament extremely inexpedient, but he never doubted their right to tax their American Colonies. In the autumn of 1774, he fled to Boston, and soon afterwards embarked for England. He refused to enter the British service, lest he should be directed to act against his native country. The king, nevertheless, granted him a pension, and he never returned to America.

Col. Saltonstall resided upon the family estate in Haverhill, in a liberal and hospitable manner, but was never married. He was characterized by integrity, frankness, a benevolent disposition, polished manners, a superior understanding and knowledge of the world, which made him much beloved, and gave him great influence. He d. Oct. 6, 1785, at Kensington, Eng., where there is a monument erected to his memory. [See Sketch of Haverhill, by Hon. Leverett Saltonstall; Mass. Hist. Coll., 2d Ser., vol. iv., p. 164-5; also, Sabine's American Loyalists.]

4. WILLIAM, b. 2d, d. 15th Nov., 1733.

5. WILLIAM, b. Oct. 17, 1734, d. Oct. 25, 1787.

(By 3d wife, Mary Cooke.)

125. 122 6. NATHANIEL, b. Feb. 10, 1746; at the age of 10 years, upon the decease of his father, was received into the family of his uncle, Meddlecott Cooke, Esq., of Boston; grad. Harv. Coll. 1766; settled in Haverhill, where he devoted his life to the practice of medicine; M.M.S.S. His classical education and general intelligence, his eminent professional skill, and conscientious discharge of duty, his gentle manners and kind disposition, and his strong attachment to the liberty and independence of his country, acquired for him great respect in the community, and the affection and entire confidence of his patients. He was remarkable for his humane and assiduous attention to the poor, consoling them by his friendly, cheerful demeanor, and by the medicines and other necessaries which he freely supplied, without the prospect of any pecuniary remuneration.

At a time when all his brothers and brothers-in-law adhered to those principles of loyalty in which they had been educated, Dr. Saltonstall remained true to those principles of civil liberty and humanity which he inherited from his worthy ancestor, Sir Richard Saltonstall, and his not less worthy son, Richard of Ipswich. This conscientious adherence to his principles separated him forever from those he most loved. It was to him a severe trial, and gave the strongest proof of his sincerity, and the strength of his principles. These had probably been much invigorated, by his training in the patriotic Cooke family.

123 7. MARY, b. Sept. 9, 1749; m. Rev. MOSES BADGER, grad. Harv. Coll. 1761; an Episcopal minister, and a loyalist. She d. Dec. 24, 1791, and he d. in Providence, R. I., in 1792. [See Sabine's Am. Loyalists.]

8. MIDDLECOTT COOKE, b. Jan. 24, d. Mar. 10, 1752.

124 9. LEVERETT, b. Dec. 25, 1754. He had nearly completed his apprenticeship with a merchant of Boston at the outbreak of the Revolution. Becoming acquainted with the British officers there, and fascinated with the profession, he accepted commission, and unlike his brother, Col. Richard, bore arms against his native land, and was engaged in several battles. He was a captain under Cornwallis, fell a victim to the hardships of a camp life, and died of consumption at New York, Dec. 20, 1782, aged 28. [See "Sketch of Haverhill," by his nephew and namesake; also, Sabine's Am. Loyalists.]

122. 125 (VL) Dr. NATHANIEL SALTONSTALL, of Haverhill, grad. Harv. Coll. 1766; m., Oct. 21, 1780, ANNA WHITE. He d. May 15, 1815, aged 69, and his wid. Anna d. Oct. 21, 1841, aged 89. [See Phillips, App. I., White 51, p. 888.] Chil.,

126 1. MARY COOKE, b. Sept. 20, 1781; m., Oct. 9, 1806, Hon. JOHN VARNUM, a native of Dracut; grad. Harv. Coll. 1798; a lawyer, of Haverhill, Rep. in Congress, &c. She d. Aug. 7, 1817, and he d. July 23, 1836. Chil.,

145 1. Nathaniel Saltonstall, b. July 19, 1812; entered U. S. army as a private; was promoted; supposed to be not living.

146 2. John Jay, b. Dec. 5, 1814; some time a student in Columb. Coll., D. C.; a farmer, of Indiana.

147 3. Richard Saltonstall, b. Ap. 13, 1817; m., June 18, 1844, Sallie Potter, dr. of William Potter, of Jonesville, Mich., where he lives, an apothecary. She d. Sept. 7, 1845, a. p.

- 148 2. LEVERETT, b. June 13, 1783; grad. Harv. Coll. 1802; studied law with Hon. Wm. Prescott, of Salem, opened an office in Haverhill, but soon (in May, 1806), moved to Salem; was devoted to his profession, and eminent as an advocate. He was speaker of Mass. H. of Representatives, President of the State Senate; the first Mayor of Salem; Rep. in U. S. Cong.; President of the Bible Society, of the Essex Agricultural Society, and of the Essex Bar; A.A. and S.H.S.; LL.D. Harv. Univ. 1838, and member of its board of overseers. [For a full and able delineation of his excellent character and services, see Discourse of Rev. John Brazier, D.D., and its Appendix.] He m., Mar. 7, 1811, MARY ELIZABETH SANDERS, dr. of Thomas Sanders, a wealthy merchant, of Salem. He d. in 1845.

Samuel Saltonstall

- Chil.,
- 149 1. *Anna Elizabeth*, unm. 2. *Caroline*, unm.
- 151 3. *Richard Gurdon*, b. June 29, 1820, d. Feb. 22, 1821.
- 152 4. *Lucy Sanders*, b. Feb. 10, 1822; m., June 30, 1847, *John Francis Tuckerman*, grad. Harv. Coll. 1837; M.D. 1841, M.M.S.S.; a surgeon in U. S. Navy; now (1854), living in Salem. Chil.,
- 153 1. *Leverett Saltonstall*, b. Ap. 19, 1848.
- 155 2. *Francis*, b. June 11, 1849. 3. *Charles Sanders*, b. Jan. 31, 1852.
- 156 5. *Leverett*, b. Mar. 16, 1825; grad. Harv. Coll. 1844; LL.B. 1847; a lawyer, of Boston. He m. in Salem, Oct. 19, 1854, *Rose Lee*, b. in 1835, dr. of John Cabot and Harriet (Rose) Lee, of Salem.
- 156 3. NATHANIEL, b. Oct. 1, 1784; at first a merchant of Baltimore, where he acquired a competent fortune; after his marriage resided in Salem, where he d., Oct. 19, 1838. He m., Nov. 30, 1820, CAROLINE, youngest dr. of Thomas Sanders, and sister of his brother Leverett's wife. Chil., all b. in Salem,
- 157 1. *Gurdon*, b. Aug. 14, d. Aug. 30, 1821.
- 157 2. *Catherine Pickman*, b. May 18, 1823; m., Ap. 28, 1846, *Edward Brooks Pierson*, grad. Harv. Coll. 1840; M.D. 1844 [son of the late Dr. Abel L. Pierson, of Salem]. She d. June 25, 1852, s. p. See [450], p. 836.
- 158 3. *Elizabeth Sanders*, b. May 26, 1825; m., Dec. 5, 1852, *George Z. Silsbee*, merchant, of Salem.
- 159 4. *Henry*, b. Mar. 2, 1828, grad. Harv. Coll. 1848; merchant, of Boston.
- 160 5. *William Gurdon*, b. Dec. 22, 1831; merchant, of Boston.
- 161 4. ANNA, b. Nov. 3, 1787; m., Nov. 28, 1820, HON. JAMES CUSHING MERRILL, b. Sept. 27, 1784; grad. Harv. Coll. 1807; a lawyer and Judge of the Police Court in Boston. He d. Oct. 4, 1853. [He was a son of Rev. Gyles Merrill, grad. Harv. Coll. 1759; minister of Plaistow, N. H.] Chil.,
- 162 1. *James Cushing*, b. Aug. 9, 1822; grad. Harv. Coll. 1842; a lawyer, of Boston; m., Oct. 30, 1850, *Jane Hyslop Hammond*, dr. of Daniel Hammond, merchant, of Boston.
- 163 2. *Samuel Gyles*, b. Ap. 15, 1824, d. Ap. 28, 1830.
- 164 3. *Anna Saltonstall*, b. June 19, 1828.
- 164 4. *Matilda Elizabeth*, b. June 22, 1832.
- 165 5. SARAH, b. Nov. 5, 1790; m., June 16, 1816, ISAAC REDINGTON HOWE, grad. Harv. Coll. 1810; a lawyer, of Haverhill; son of David Howe, Esq., merchant, of Haverhill. Chil.,
- 166 1. *Nathaniel Saltonstall*, b. Ap. 24, 1817; grad. Yale Coll. 1835; m., June 26, 1846, *Sarah A. Bradley*, dr. of Charles Bradley, of Rox., merchant, of Boston. He is a lawyer, of Haverhill, and Judge of Probate, and has been a member of Mass. Senate. Chil.,
- 167 1. *Susan Bradley*, b. in Rox., June 25, 1847.
- 168 2. *Henry Saltonstall*, b. in Haverhill, Aug. 12, 1848.
- 169 2. *Mary Cooke*, b. Mar. 25, 1819; m., Sept. 30, 1851, *James H. Carlton*, merchant, of Haverhill.
3. *Caroline Matilda*, b. Sept. 27, 1821, d. Aug. 9, 1844.
4. *Ann Elizabeth*, b. Nov. 14, 1823, d. July 7, 1845.
5. *William Garland*, b. June 28, d. Aug. 26, 1826.
6. *Frances Garland*, b. Oct. 8, 1827, d. Sept. 5, 1828.

- 170 7. *William Garland*, b. Aug. 1, 1829; a merchant.
- 171 8. *Francis Saltonstall*, b. Nov. 8, 1831; now (1854), a student in the Law School at Cambridge.
- 172 6. **RICHARD**, b. June 16, 1794; grad. Harv. Coll. 1813; was a merchant, of Baltimore, where he m. **MARGARET ANN SAVAGE**. He d. at sea, in 1834, and she d. Nov. 1, 1834. Chil. b. in Baltimore.
- 173 1. *Richard*, b. Aug. 28, 1823; a merchant, of New York; m. *Maria J. Daniel*. Chil.,
1. *Margaret Ann*, b. July, 1852. 2. *Leverett*, b. Aug. 11, 1853.
- 174 2. *Anna White*, b. Oct. 19, 1827; of Haverhill.
- 175 7. **MATILDA**, b. Dec. 9, 1796; m., June 6, 1825, **FISHER HOWE**, merchant, of New York. She d. in Brooklyn, May 21, 1831. Chil. b. in N. Y.
1. *Henry Fisher*, b. Nov. 30, 1826, d. July 8, 1827.
- 176 2. *Matilda Saltonstall*, b. May 15, 1828; m., Ap. 18, 1848, *William R. Gould*, broker, of Brooklyn, N. Y. Chil.,
1. *William Saltonstall*, b. Feb. 7, 1849.
2. *Edward Peters*, b. Mar. 6, d. Ap. 23, 1850.
3. *Frederick*, b. Nov. 24, 1851. 4. *Edward Peters*, b. Ap. 10, 1853.
-
- 180 **Capt. NATHANIEL SALTONSTALL**, of New London (supposed to be a descendant of the Governor), was appointed, in April, 1775, Captain of the old ante-revolutionary fort of New London, which stood on the water's edge, near the centre of the town. Fort Trumbull was built the next year just below the town, and of this, he was the first commander. He afterwards went into the marine service, and was commander of the ship Putnam, under Commodore Dudley Saltonstall, in the expedition against Penobscot, 1779. The ship was blown up, but the officers and crew escaped. He m. (1st), Sept. 15, 1755, **REBECCA YOUNG**, of Wethersfield, Conn. She d. Oct. 8, 1766, aged 39. He m. (2d), Dec. 21, 1768, **LUCRETIA**, dr. of Peter Latimer. In advanced age he moved to Marietta, O., where he d., Aug. 1, 1807, aged 79 or 80 years; and his wid. *Lucretia*, d. in 1822. Chil.,
-
- 181 1. **REBECCA**, b. in 1756; m., Dec. 1, 1778, **WILLIAM EVANS**, of Newark, N. J.
- 182 2. **SARAH**, b. in 1758.
- 186 3. **GURDON F.**, b. May 18, 1760; d. in Cincinnati, O., Jan. 30, 1836, aged 76. No record obtained of his family and descendants.
- 184 4. **JOSEPH L.**, b. June 8, 1763.
(By 2d wife, *Lucretia*.)
- 185 5. **LUCRETIA**, b. Aug. 1, 1770; m. **GILES HEMPSTEAD**.
- 186 6. **MARY**, b. Aug. 18, 1772.
- 187 7. **NANCY**, b. July 6, 1774; m. **Rev. STEPHEN LINDSLEY**, of Ohio.
- 188 8. **NATHANIEL**, b. Dec. 18, 1776; of New London (the only one of his father's family, who remained there); m., May 22, 1800, **LUCRETIA LANPHEER**, who d. Sept. 18, 1849. 2 sons, and 8 drs. The two sons and three drs., are deceased. Four of the drs. m. gentlemen of New York, viz.,
189 1. *Eliza*, m. *Andrew Arcularius*. She d. May 22, 1851.
- 190 2. *Augusta*, m. *Peter G. Arcularius*.
- 191 3. *Maria*, m. *Peter R. Bonnett*.
- 192 4. *Mary*, m. *Henry Anstice*.
- 193 9. **JOHN L.**, b. Jan. 26, 1781; d. at Marietta, O., Ap. 15, 1821.
10. **BETSEY**, b. Ap. 1, 1784; d. Nov. 23, 1786.
-
- p. 416. **SANDERSON**.—In 1713-14, Robert Sanderson, goldsmith, of Boston, and wife Esther, sold 11 acres of land in Watertown. Robert Sanders, a foreigner and pauper, d. in Wat., Sept. 8, 1824, supposed to be aged 96.
- [1.] In a deed [John Ball to Richard Child, vol. vi., pp. 18 and 19], Edward Saunders is mentioned as a proprietor, of Wat., in 1674. *Mary Eggleston*, dr. of Bigot, was born Mar. 29, 1641, and *Mary*, wife of Edward Sanderson, may have been a sister of Bigot. Jan. 29, 1660-1, Edward Sanderson was then living in Wat., with six chil., in indigence. *Ann Sanders*, of Wat., was bap. in 1st Church of Boston, Oct. 29, 1654. It was probably his widow ("Sanders"), who was assisted by the selectmen,

in Jan., 1687. There is little doubt that Abigail Saunders, wife of Shubael Child [5], and Hannah Saunders, wife of Richard Norcross, Jr. [10], were drs. of Edward Sanderson.

- p. 417. [4.] Dea. Jonathan Sanderson was selectman, 1703, 4, 5, 6, 14, 15, 16, 17, 18, 19. May 13, 1681, Jonathan Sanderson, for £35, bought of Daniel Andrews, of Salem, 35 acres of land in Wat., lying between Samuel Thatcher and Samuel Daniels. [See Andrews, p. 674.]
- [5.] Respecting Hannah Priest, see Price, p. 911.
- Mar. 12, 1702-3, Thomas Sanderson, of Wat., sold to Jonathan Smith and John Bemis, 35 A., bounded W. by heirs of Richard Saltonstall; N. by Joseph Peirce, and Eleazer Whitney; S. by Stephen and Jonathan Coolidge; E. by John Morse. [See Cutler, 23, p. 751.]
- Mar. 13, 1710-11, caution against (settlement of) Hannah Sanderson, from Cambridge. Was she that dr. of Dea. Jonathan Sanderson, [12.], who m. George Stearns?
- p. 418. [†27.] (?) Elizabeth, the wid. of John Child (who left an only son John), m. Jacob Sanderson.
- [26.] Dec. 2, 1766, caution against (settlement of) Moses Sanders (? Sanderson), from Camb., Nov., 1765. Oct. 11, 1767, Sarah Saunders, c. c., in Wat., and at the same time, Sarah, dr. of Moses and Sarah Sanders, was baptized.
- [27.] John Sanderson was dismissed from Waltham to Leicester, Ap. 8, 1744; probably a few years after his removal.
- [45.] The Will of Thomas Sanderson was proved May 9, 1763.
- p. 419. [56.] SAMUEL SANDERSON moved to Lancaster, in 1776, where he d. about 1800; and his wid. d. in E. Lex., at her granddaughter's, Mrs. Caroline Goodnow, Oct. 15, 1852, aged 104 yrs. and 5 days. [For a full account of her, see Locke Family, pp. 67 and 367.] Chil.,
1. *Amos*, d. unm.
 2. *Isaac*, of E. Camb.
 3. *Mary*, m. *Daniel Clark*, of Salem.
 4. *Samuel*, b. Jan. 17, 1776; of Waltham. [151.], below.
 5. *Nancy*, unm., residing with her brother.
 6. *Lydia*, m., 1820, *Ezra Fiske*, of Weston. [N. Fiske, 145.] He d. Oct. 17, 1831.
 1. Abigail, b. Oct. 12, 1823.
 2. *Ezra*, b. Aug. 21, 1825.
- [81.] Thomas Sanderson d. in Waltham, Mar. 23, 1855, æt. 89.
- [84.] Grace Sanderson d. Ap. 1, 1855, aged 79, unm.
- p. 420. [94.] Abraham Sanderson, then said to be "of Waltham," belonged to Capt. Jonathan Brown's Company, at Lake George, in 1758.
- [97.] Isaac Sanderson, Jr., an only son, b. Aug. 24, 1805; m., Jan. 9, 1831, Alice Badlam, b. May 1, 1811.
- [120.] In a suit, Mar. 26, 1681, Wm. Sanderson was a witness, then aged 40, showing that he was b. in 1641. This could not be the William Sanderson, who took the oath of fidelity in 1652.
- [126.] The estate of Amos Sanderson was divided Oct. 4, 1767.
- [127.] Isaac Sanderson, a cordwainer, was selectman of Wat., 1749. His estate was divided to sons Josiah and Henry, Dec. 12, 1677.
- [129.] Had this Josiah Sanderson, a 2d wife, Sybil? His Inventory, dated May 25, 1808, \$6610.
- p. 421. [151.] SAMUEL SANDERSON, Jr., a farmer, of Waltham, d. July 18, 1829. Chil. by wife EUNICE.
1. *Benjamin Lawrence*, b. Oct. 30, 1802; of W. Camb.; m., Oct. 26, 1822, *Mary C. Cook*, of W. Camb. He d. Aug., 1840. Chil.,
 1. Theodore Lyman.
 2. Emily.
 3. Clarence Marcellus.
 2. *Marshall*, b. Jan. 1, 1805; supposed to have been lost at sea, about 1823.
 3. *Chester*, b. Ap. 6, 1807; of Boston; m., May 17, 1831, *Sarah Stickney*, of Francis-town, N. H. Chil., 1. Harriet Ann. 2. Charles Henry, d. 3. Elbridge Lawrence. 4. Sarah Caroline.
 4. *Caroline*, b. Oct. 15, 1809; m., May 15, 1834, Edward Goodnow, of Lex., who d. Oct. 15, 1840. His wid. resides in E. Lexington.
 5. *Grace*, b. Nov. 30, 1812; d. July 4, 1830.
 6. *Harriet*, b. May 21, 1815; d. 1828.
 7. *Elizabeth Herrick*, b. Sept. 20, 1824, unm., living with sister Caroline.

SANGER.—[See Reynolds, p. 912.] [3.] Admin. upon the estate of Nathaniel Sanger, of Woodstock, was granted to his brother David, Jan. 9, 1695-6.

- p. 422. [7½.] David Sanger, probably did not d. so early as 1695.
 [8.] Feb. 4, 1690, Richard Sanger, of Wat., smith, and wife Mary, for £80, sold to son John Sanger, smith, 9 A. of land in Wat., near Loveran and Benjamin's land. Inventory of John Sanger, dated Jan. 5, 1704-5. House, 9 A. of land, and smith's tools, £80; 2 acres meadow, £20; 53 A. of woodland in Newton, £30. In 1711, the town paid wid. Rebecca Sanger, £2 10s., for supporting her aged mother (? mother-in-law). Wid. Rebecca Sanger moved to Newton (her native town), about 1721 or 22.
 [9.] Inventory of John Sanger, Jun., dated Feb. 24, 1711-12, £36.
 [16.] Lieut. David Sanger was selectman of Wat., 1773, 74, 75, 76, 79, 85, 87, 88, 89, 90, 91.
- p. 423. [38.] Solomon Sanger, youngest son of David, belonged to Capt. Jonathan Brown's Company, at Lake George, in 1758.

SAVAGE.—The estate of John Savage, of Wat., declared to be insolvent by his wid. Hannah, Jan. 12, 1761. Samuel Savage, (grad. Harv. Coll., 1766,) Faith, John, Lucy, and Sally Savage, were children of Samuel Phillips Savage, of Boston. Samuel Phillips Savage, Esq., and Mary Messerve, both of Weston, m., in Weston, Jan. 21, 1794.

-
- SAWIN.**—[1.] John Sawin was selectman of Wat., 1664 and 72. [See Thomas Boylston, p. 702.]
 [1½.] John Sawin "was the first white inhabitant" of Natick. Ap. 8, 1692, Daniel Tokawombait, a Natick Indian and preacher, ordained by the Apostle Elliot, sold a meadow to John Sawin. [See Bigelow's Hist. of Natick, pp. 52 and 54.] Ap., 1697, John Sawin and Judith his wife, sold to John Livermore 30 acres in the west of Wat. [Weston], called Sawin's Plain. He was of Wat. Farms in 1694. The first mill erected in Natick was a saw-mill, built by him on Charles River, about 1720. As his dam prevented the draining the large meadows, he moved his saw-mill upon a brook, and there also built a grist-mill. There is now a stream of water in Natick, called Sawin's Brook.
- p. 424. [15.] John Sawin was constable of Wat., 1734, and selectman, 1736 and 37.
 [25.] This is supposed to be the John Sawin who m. Hepzibah Hastings. [See 63, p. 790.]

-
- SAWTEL.**—Richard Sawtel, "an aged man" d. in Wat., Aug. 21, 1694. At what time he returned to Watertown, or how long he resided in Groton, has not been ascertained. Probably he was driven back by Indian hostilities, about 1675 or 6. His Inventory was taken by residents of Wat., and his lands were there, except "a 20 acre right in Groton lands." Admin. on the estate of his wid. Elizabeth, was granted to son Enoch, of Wat., Nov. 26, 1694, and her Inventory was dated Dec. 5, 1694.
- p. 425. [3-6.] June 16, 1691, Jonathan Sawtel, of Groton, aged 15 yrs., chose his uncle Abraham Holman, to be his guardian.
 [5.] Hannah Sawtel, m., July 13, 1665, Increase Winn, son of Edward, of Woburn. His birth is the first recorded in Woburn, Dec. 5, 1641.
 [7.] Enoch Sawtel m. Susanna Randall. [7.]

SCOTT.—Mar. 13, 1759, caution against (settlement of) Abraham Scott, from Lex., last summer. Mar. 23, 1762, caution against (settlement of) Jonathan Scott, from Rox., last Aug. or Sept.

-
- SEAVERNS.**—Samuel Seaverns m., in Charlestown, Feb. 23, 1665, Sarah Grant. [Grant, 6.] It has not been ascertained that they had more than one child Samuel. After the death of her husband she returned to her native town, and m. (2d) after May 9, 1694, Thomas Sylvester, q. v.
- p. 426. [27.] Elisha Seaverns, m., Oct. 27, 1774, Elizabeth Whittemore, from Medford, "both of Newton," where he was selectman 3 yrs. He d. there, Dec. 19, 1831, aged 86, and she d. Aug. 24, 1830, aged 77. Chil., 1. Patience, b. Aug. 24, 1777, d. soon. 2. Patience, b. Aug. 27, 1779; m., 1798, Walter Ware, who took her father's home-stead.

SEELEY.—Robert Seeley was second in command, under Capt. John Mason, in

the Pequod war, and one of the signers of the original agreement, entered into by the first settlers of New Haven, in 1639. [See Hinman, p. 76.]

SEGER.—The land of William Seger, is mentioned as a boundary in 1642-3.

- p. 427. **SHATTUCK.**—[5.] For Mar. 8, read May 8. Mr. Morse [Memorial of Morses, p. 89], supposes that Mary, wife of this John Shattuck, was a dr. of John Morse. (See Morse, [1.], p. 859.)
- [7.] Was it the wid. or dr. of Jonathan Shattuck, who m., John Shed, in Groton, Nov. 14, 1732?
- [10½.] Elizabeth Shattuck, m., Jan. 27, 1725-6, Isaac Lakin, b. Dec. 11, 1702, son of Wm. and Elizabeth, of Groton. 5 chil.
- [13.] Jan. 24, 1691-2, William Shattuck, Jr., had permission to set up a tent or place to dwell, on the town's land, about Patch Meadow, and in March, the selectmen gave him liberty to fell timber for a house 14 ft. square. Nov. 16, 1702, town voted to lease to John Green, for 3 years, for £4, the house, &c., that Wm. Shattuck, Jr., did improve; and if said W. S., Jr., deliver to John Green, the house, &c., within 8 days, the town will give him the £4, as a gratuity to help him in removing to Groton. Chil. of Wm. Shattuck, of Groton. 1. William, ? m., Mar. 24, 1718-19, Deliverance Pease. 2. Hannah. 3. Daniel. 4. Ruth, b. Oct., 1794; m. Ebenezer Nutting. 5. John. [Did this John m., about 1724-5, Mary — ?] July 28, 1700, caution (by Wat.) against (settlement of) Hannah Shattuck, belonging to Groton.
- [15.] In some early legal instruments, Phillip Shattuck is designated weaver. He had two sons named Phillip living at the same time, one by each wife. Ap. 6, 1671, Michael Bairstow, of Wat., for love and affection to kinswoman Deborah, wife of Phillip Shattuck, of Wat., gives to Phillip and Deborah 6 acres, bounded E. by Richard Sawtel; S. by wid. Kembal and John Dix; W. by John Eddy; N. by Camb. line. It is not unlikely that Deborah lived with her uncle Michael, as he had no children, and her father was dead, and that this was a marriage portion, bestowed a few months after her marriage. [See p. 678.]
- p. 428. [17.] Phillip Shattuck m., Jan. 6, 1704, Margaret Pratt, of Saybrook.
- [18.] Susanna, m. Nathaniel Norcross [18].
- [19.] For Anne, read Anna.
- [27.] For physician, read, barber-chirurgeon. In 1714, Jabez Beers, tailor, of Wat., and wife Elizabeth, sold land to Joseph Shattuck, barber-chirurgeon of Wat., and his wife Mary.
- [27-8.] John Shattuck m., in 1749, Martha Hammond [90, p. 782]. Son William, b. Dec. 14, 1749.
- [28½.] Dr. Phillip and Rebecca, between Nathaniel [28] and Amos [29], had a son Isaac. This Isaac Shattuck, and wife Mary, were adm. f. c. at Westboro, Oct. 17, 1725. Chil.,
1. Sybil, b. Ap. 15, 1724; m., May 20, 1742, Jonas Child.
 2. Mary, b. Aug. 10, 1726.
- [Mary Shattuck adm. f. c. Westboro, Mar. 26, 1727. Mary, wife of Josiah Walker, formerly Shattuck, adm. f. c. Westboro, Nov. 3, 1734. Sarah Shattuck m. in W., May 24, 1744, Elijah Rice.]
- [32.] (?) Phillip Shattuck, of Wat., and Jane M'Clenning, pub. in Boston, June 4, 1734. He was probably the Philip Shattuck who d. in Waltham, at Samuel Parkhurst's house, in May, 1744.
- [34.] William Shattuck m. Susanna Randall, May 22, 1674. Jan. 22, 1680, he bought of Phillip Jones, of Camb., 40 A. of land in Camb. Nov. 23, 1691, the selectmen ordered "Phillip Shattuck to provide for his cousin, the wife of William Shattuck, who is in the country service, and for the two children." He entered the service Nov. 18th.
- [35.] For Nov. 3, read 23.
- [36.] For Dec. 23, 1721, read, Dec. 21, 1723. Joseph Mason, Esq., was executor of estate of William Shattuck, Jr., in 1738.
- [37.] For Hays, read Fay.
- [40.] Josiah Shattuck m. (2d), Jan. 11, 1753, Mary Hastings, of Camb. The Will of Josiah Shattuck, yeoman, of Camb., dated Mar. 22, 1771 (not signed), gave all his movable estate to his wife Mary, she to pay funeral expenses; also, the use and improvement of that part of my real estate which was my late father's, Mr. Benjamin

Shattuck, late of Camb., deceased, during her natural life; to dr. Susanna the reversion and residue of my estate; if dr. Susanna should die without heirs, the real estate is to go to the town of Watertown, not to be sold, but the profits or income to go for the support of English schools.

p. 429. [†47.] Strike this out. See 52, p. 429.

[44.] Read, Joseph, d. Oct. 15, 1694.

[45.] For Dec. 15, 1726, read, Dec. 4, 1729.

[47.] Susanna Shattuck m. Samuel Holden [12]. 9 chil.

[50.] Abigail Shattuck m. (1st), Oct. 17, 1678, Jonathan Morse [Morse, 53]. He d. in Groton, July 31, 1686, and she m. (2d), in Chelmsford, Joshua Parker, b. Mar. 13, 1658, son of James and Elizabeth (Long) Parker, of Groton, by whom she had dr. Abiel, who m., Nov. 15, 1711, George Harrington, of Wat. [Harrington, 61]. The Inventory of wid. Abigail Parker was dated Sept. 12, 1694. Phillip Shattuck, Sen., [brother of Abigail], was appointed, Sept. 24, 1694, administrator of Abigail Parker, wid. [of Joshua], formerly wife of Jonathan Morse, of Groton.

[51.] Petition of Phillip and William Shattuck, dated June 19, 1683, heirs of William Shattuck, concerning their brother Benjamin, who d. aged 20, after long sickness.

SHAW.—[See Mitchell's Hist. of Bridgewater, p. 290.]

- p. 429. **SHERMAN.**—Samuel Sherman, an early settler of Boston, was not the Samuel Sherman who went from Watertown with the first settlers of Wethersfield. The latter, it is said, was a brother of Rev. John Sherman. It appears, also [Hist. of Glastenbury, p. 163], that he was a son of Joseph [? Edmund] Sherman, of Wethersfield, one of the original grantees of the Naubuc Farms, who, in 1641, gave this farm [144 acres] to his son Samuel. If these statements be correct, this Joseph was the father of Rev. John Sherman, of Watertown, and the father and his two sons may have gone to Wethersfield together. Samuel Sherman was one of those twenty Wethersfield men who purchased Stamford, Oct. 30, 1640; from Stamford he moved to Stratford, where he died, Oct. 1684. In 1672, he was the first of the subscribers to the fundamental articles for the plantation of Woodbury (Pomparague), Conn. He m., about 1640, Sarah Mitchell, daughter of Matthew, of Wethersfield, afterwards of Stamford, sister of Rev. Jonathan Mitchell, of Cambridge. [For a Genealogy of his family and descendants, see Cothren's Hist. of Woodbury, p. 682; also, p. 633.] He was a magistrate, 1664, and, at a General Assembly, Oct. 13, 1664, the Court granted him "a farm of 250 acres of land upon New Haven River, whereof 50 acres may be meadow, so it be out of the bounds of the town."
- p. 430. [2.] For dr. of Roger and Grace Porter, read, dr. of William Palmer. [See Palmer, p. 865, and Porter, p. 910]. Capt. John Sherman was Rep. again in 1682. At a court, in June, 1654, Serg. Sherman was accepted as Ensign of Watertown company, and he did not attain the rank of Captain until 1680, or, perhaps, 1681, when he was about 67 years old. His residence or homestall (which passed to his son Joseph), consisting of two parcels of land, was bounded as follows, viz.: 30 acres, bounded N. by Strawberry Hill; E. by Capt. Bond and John Perry; S. by Joshua Whitney (what had been the homestall of his father, John Whitney), Nathan Fiske, and Henry Spring; W. by a lane or highway. Also, 14 acres, bounded E. by said lane; N. by Strawberry Hill; W. by Nathaniel Bright; S. by Nathan Fiske and Benjamin Wellington.
- [3.] See Geneal. Reg. viii., p. 241.
- [7.] Elizabeth, wife of Samuel Gaskill, d. in Camb., Oct. 18, 1686.
- [10.] John Sherman m. (1st), Mary Bullen, and moved to Charlestown as early as 1722. He m. (2d), in Charlestown, May 1, 1729, Mary Stone. Margaret, wid. of John Sherman, d. in Charlestown, June 13, 1758, aged 68 [gravestone].
- [10-4.] Ephraim Sherman and Thankful Temple, of Marlboro, m. in Westboro, May 16, 1733.
- [10-6.] Strike out all after 1718.
- p. 431. [13.] Abiel, wife of Samuel Sherman, bap. in Charlestown, July 7, 1718.
- [14.] Elizabeth, wife of Jona. Sherman, adm. f. c. Charlestown, Jan. 19, 1706-7.
- ☞ James Sherman d. in Charlestown, June 10, 1729, aged 38 [gravestone]. Was he a son of Joseph [12]?
- [23.] Mrs. Mehitabel (Sherman) Battall. [See Hist. Woodbury, p. 508.]
- p. 432. [41.] Rev. Josiah Sherman, b. Ap. 2, 1729, d. Nov. 24, 1789.
- [42.] Hon. R. M. Sherman m. Elizabeth Gould, b. Mar. 1, 1774, dr. of Dr. William and

- Mary (Guy) Gould, of Branford, Conn. He d. 1844, and his wid. d. Aug. 12, 1848. [See Foote Family, p. 185.]
- [50.] Rev. John Sherman was dismissed May 29, 1635, from Watertown Church to Wethersfield. He resided in Wethersfield until after May 7, 1640, when the Court of Connecticut ordered that "Mr. John Sherman, of Wethersfield, be freed from watching until the Court take further order." His name is on the list of free planters of Milford, Conn., Nov. 20, 1639, and he was admitted to the Church of Milford, Nov. 8, 1640. At a General Court of New Haven, Nov. 24, 1640, he was one of the five persons chosen magistrates of the plantation [Colony of New Haven]. At a General Court, May 27, 1641, "John Sherman is, till the next Court of Election, to join with four others [the other magistrates, Wm. Fowler, Edmond Tappe, Zechariah Whitman, and John Astwood], in dividing of land, and to receive inhabitants." In Nov., 1643, his possessions were a house, lot 4½ acres, meadow 9½ A., and upland 20 A. He was invited to become a minister of Milford, but declined. He was dismissed from Milford Church, Nov. 8, 1647, which was probably about the date of his return and settlement in Watertown, where he had a child born less than three months afterwards. There is no record in Wethersfield or Milford of either of his marriages, or of the births of his children. The births of only 5 (not 7) of his children are recorded in Watertown, although several others were undoubtedly born there. [For an account of his eminent talents, learning, services, and Christian character, see Mather's Mag., book iii., part ii., chap. 29; also, Francis's Hist. of Watertown.]
- [55.] Rev. James Sherman was dismissed at Sudbury, May 22, 1705, and he d. Mar. 3, 1718. Mar. 11, 1708-9, Simeon Stoddard, of Boston, for £85, sold to John Holden and John Traine, Jr., land in Nonesuch [in Weston], formerly of James Sherman, of Salem, physician, otherwise, James Sherman, of Watertown, clerk, taken from him on execution. Same date (Mar. 11, 1708-9), James Sherman, of Salem, physician, and wife Mary, for £139, sold to John Holden and John Traine, Jr., both of Wat., a sawmill and 333 acres of land, in platt surveyed by David Fiske, May 5, 1694, by order of Court, passed Mar. 27, 1685, except 35 A. at South End, in possession of Benjamin Walker, and 77 A. in possession of Simeon Stoddard [above stated].
- [56.] Abiah Sherman was a witness, Sept. 24, 1683, then aged 19; therefore b. about 1664. He, then of Wat., was adm. freeman Mar. 22, 1689-90.
- [58.] See [7], p. 934. The two Elizabeth Shermans, m. Gaskills. Elizabeth, the dr. of Rev. John Sherman, was living 1713.
- [62.] In 1713, Samuel Barnard and wife Mercy, executed a deed in favor of sisters-in-law Mary, and wid. Elizabeth Gaskill, of New Haven.

SHURTLOE.—(?Shurtleff.) Mar. 14, 1731-2, caution against (settlement of) James Shurtloe and family, from Brooklyn, Nov. 30. [See T. Hammond [156], p. 784.]

- p. 433. **SIMPSON.**—A lot of land in Wat., sold Oct. 27, 1662, by John Lawrence, was bounded S. by "Capt. John Simpson." Suit in Court, Sept. 10, 1695, John Simpson vs. John Chadwick, to recover 4 A. of Remote Meadow, being the 100th lot, and granted to John Simpson, the grandfather of the plaintiff. Sureties, Jonathan Simpson and John Wait. Verdict for the def't and costs.
-

SLOPER.—Jan. 1, 1753, caution against (settlement of) John Sloper and Olive Sloper, from Boston, Dec. 22.

- SMITH.**—Samuel Smith, aged 32, with wife Elizabeth, aged 32; chil., 1. Samuel, aged 9 yrs., 2. Elizabeth, aged 7 yrs., 3. Mary, aged 4 yrs., 4. Phillip, aged 1 yr., embarked at Ipswich, in Ap., 1634, in the Elizabeth, with several Watertown families. It is probable that he first went to Watertown, and the next year (1635) joined that company of Watertown people, that went to Wethersfield. See Hollister, Hist. Conn. I., p. 455; Hist. of Glastenbury, pp. 34 and 166; also Mass. Col. Records, I., p. 171.
- [2.] Francis Smith was a proprietor in 1642, and in that year, 131 A. of farm land was granted to him. The Will of Francis Smith, of Reading, dated Mar. 14, 1650-1 (he d. Mar. 20th), mentions wife (not named): sons, John and Benjamin; gr. dr. Mary Smith. To my kinsmen Henry and Benjamin Bulflower, of the town (T-iffe), each £3. For fencing the burial lot, £3.
- [5.] The Will of Thomas Smith, was proved May 8, 1693.

- [6.] James Smith m., in Sud., 1680, Hannah Goodnow, b. 1656, dr. of John and Mary, and gr. dr. of Edmund and Anne. [Barry, p. 264.]
- [104.] Ap. 9, 1666, Ephraim Smith was then aged about 20 yrs.
- p. 434. [12.] Ap. 6, 1697, Thomas Smith [12], of Camb. [Lex.], and Mary Smith [his mother], of Wat., ex'rs of Thomas Smith, for £65, sold to Timothy Hawkins, a house and 20 acres in Wat., bounded E. by T. H.; W. by Geo. Lawrence, and John (? Jos.) Wellington; N. by G. L., John Hastings, and John Kemball; S. by John Barnard, and Thomas Harrington. This was probably the residence of Thomas Smith, Sen. [5.]
- [15.] For 15, in the margin, read 40.15.
- [25.] This Hannah Tidd, was probably a dr. of John Tidd, of Woburn, and b. Sept. 21, 1652, the first of the name b. there.
- [27.] Mar. 31, 1704, Joseph Smith, of Wat., and wife Hannah, sold to son John, 30 A. in Wat.; also another lot of 20 A., and 4 A. in Camb., and another of 4 A. in Wat. This is supposed to be the John Smith, late of Wat., d., on whose estate Thomas Mead was appointed administrator, Feb. 25, 1717-18.
- [31.] Lieut. Jonathan Smith was selectman of Wat., 1703, 4, 5, 6, 14, 15, 16. His wid. Jane, d. Nov. 5, 1726, and her Inventory, dated Mar. 9, 1727.
- [32 and 34.] Zechariah Smith and his brother Elieha, fined in 1733 and 34, for obstructing Samuel Whittemore, Constable of Cambridge.
- [35.] Sept. 17, 1728, Jonas Smith, of Wat., "gentleman," fined 10s. for breaking into the dwelling of Isaac Temple, of Shrewsbury, to serve a warrant. Elisha Smith, of Weston, security.
- p. 435. [52.] It was probably Mary Smith [94], who m. Jabez Wyman.
- [53.] Hezekiah Smith and wife, dismissed from Waltham to Lex., July 30, 1736.
- [67.] Was this the Thaddeus Smith, who settled in Ashby, and there m., Ap. 13, 1775, Silence Jones? [130.]
- p. 436. [85.] For Simon, read Simeon. [See Mitchell's Hist. Bridgewater, p. 237.]
- [86.] Ebenezer Munroe, b. Nov. 15, 1744, was a son of Robert and Anna (Stone) Munroe, of Lex. [See [64], p. 523]
- [95.] The estate of Daniel Smith, was divided Ap. 14, 1759.
- [99.] ? Sarah Smith, of Lex., m., in Wob., Jan. 14, 1742, Abial Richardson.
- p. 437. [118.] See Harris, [41] p. 788.
- p. 439. [200.] Elizabeth, wife of Daniel Smith, was a dr. of Thomas and Grace Rogers. [See Palmer, p. 865.] The Will of Daniel Smith, was proved Oct. 2, 1660; Inventory dated Sept. 24, 1660, £260. 11s.
- [204.] Aug. 17, 1710, John Smith, of Newton, son of Daniel, of Wat., d., who made his Will, Mar. 13, 1707-8, gave power of att'y to his friend Daniel Smith, of Wat.
- [221.] Col. Bradly Smith, of Weston, was Rep. 1775 and 76.
- N.B. William Hammond, Sen. [1, p. 269], in his Will, mentions his dr. Sarah Smith, and her son Adam Smith.

SPENCER.—Caution, Dec. 12, 1721, against (settlement of) Ammi Ruhamah Spencer and family, last from Cambridge to Wat.

- p. 442. **SPRING.**—The Will of Robert Spring, of Boston, mariner, dated Feb. 20, proved Mar. 12, 1743-4, mentions wife Mercy, to whom he gave house, &c., in Charlestown, and sons Robert, Samuel, and Thomas. [Suff. Prob. xxxvii., p. 222.]
- Henry Spring [3.], and John Spring [4.], took the oath of fidelity in 1652.
- [5.] In a sale of land, in 1651-2, William Spring is twice mentioned as a proprietor of land.
- [13.] For selectman 20 yrs., read 8 yrs.
- [18.] For Mercy, read Mary.
- p. 443. [21.] Henry Spring, d. Nov. 24, 1749, æt. 88.
- [29.] Admin. on estate of Thomas Spring was granted to his wid. Elizabeth, Aug. 14, 1710. Inventory dated July 26, 1710, house, and about 100 acres.
- [33.] Ensign John, of Newton, a selectman 12 yrs., m., Mar. 8, 1704, Joanna Richards, of Dedham. She d. Oct. 5, 1747. He d. intestate, and son Samuel took the homestead. His Inventory, £2684 16s. 1d. (? O. T.).
- [34.] Chil. of WILLIAM and ABIGAIL (Coolidge) SPRING.
1. Thaddeus, b. Ap. 9, 1730; m., 1762, *Patience Jackson*, dr. of Joseph and Patience (Hyde) Jackson, of Newton, and settled in Hopkinton, where he was a school-master.
 1. Anna. 2. Patience.

2. *Wm.*, b. June 24, 1732; d. Dec. 15, 1744. 3. *Daniel*, b. Ap. 28, 1734.
 4. *Simeon*, b. Jan. 31, 1737; d. Jan. 22, 1745.
 5. *Abigail*, b. July 31, 1739; d. Dec. 30, 1744.
 6. *Joanna*, b. June 21, 1743; d. Jan. 30, 1745.
 7. *Joanna*, d. Ap. 2, 1745. 8. *William*, b. Mar. 15, 1746.
 9. *Abigail*, b. July 9, 1748. 10. *Simeon*, b. Jan. 20, 1753.
 [38.] Deborah Spring, m., 1735, Jonathan Williams, b. Dec. 16, 1711, son of Isaac and Martha (Whitney) Williams, of Newton. 5 chil. [See Williams Fam., pp. 157 and 8.]
 [39.] Nathaniel Spring, m., Dec. 10, 1741, Martha Williams, b. Mar. 18, 1714, sister of Jonathan, preceding.
 [40.] Hannah Spring, m., Oct. 29, 1734, Daniel Trowbridge [16]. The date of her birth should probably be 1711-12, instead of 1721-2, and was next older than Deborah.
 [41.] Admin. of estate of Samuel Spring, granted to his wid. Thankful, Dec. 2, 1772.
 [42.] Henry Spring was selectman 1748, 56, 57, 58. His wife's father, Josiah Converse, m., in Woburn, Oct. 8, 1685, Ruth Marshall.
 [43.] JOSIAH SPRING, m. CATHERINE —, and settled in Ashford, Conn. His d. not recorded. His wid. Catherine, m., in Ashford, Nov. 13, 1755, Ezra Smith. Chil.,
 1. *Josiah*, b. Oct. 26, 1743; d. Oct. 5, 1748.
 2. *Kezia*, b. Oct. 21, 1745; m., in 1767, Capt. John Jennison, a farmer, of Walpole, N. H. She d. Ap. 10, 1771, leaving two sons, Josiah and John. [See Jennison, [123.], p. 807.]
 3. *Samuel*, b. Sept. 20, 1747. 4. *Catherine*, b. Mar. 3, 1750.
 p. 444. [45.] *Kezia* d. Ap. 18, 1744. [46.] *Mary* d. Ap. 16, 1744.
 [47.] *Samuel* d. Ap. 30, 1744. [48.] *Lydia* d. Ap. 17, 1744.
 [49.] "Jeduthan" (? Jedediah), was a Corporal in Capt. Jonathan Brown's company, at Lake George, in 1758. His brother Josiah belonged to the same company.
 [58.] Sarah, dr. of James Gray, was bap. in Wat., Dec. 6, 1761. Sarah Gray (his wife), was dismissed to Stockbridge, Sept. 29, 1765.
 [60.] Dr. Marshall Spring was Constable of Wat., 1797. His grandfather, Josiah Converse, m., Oct. 8, 1685, Ruth Marshall, whence his name.
 p. 445. Chil. of MARSHALL BINNEY, and ELIZA (Willing) SPRING.
 1. *Elizabeth*, d. 1834. 2. *Nancy W. C.*, m. — Wharton, of Philadelphia.
 3. *Marshall*, d. 1839. 4. *Mary*, m. *Edward Perkins*, s. p.
 [79.] Strike out, probably. [See Bullard, [11.], p. 732; and see Upham, [1,] p. 612.] Henry Spring was Capt. of a Co., in the spring of 1758.
 p. 446. [95.] Rev. ELIAS DUDLEY, b. in Saybrook, Conn., Aug. 12, 1761, son of Daniel and Susanna Dudley (who moved from S. to Newport, N. H., where he d. Feb. 1, 1811, aged 92); grad. Dart. Coll., 1788, ordained in Oxford, Ap. 13, 1791. He m., Oct. 22, 1793, MARY SPRING. About 1805, he moved to Prospect, Me., where he d. of consumption, Jan. 25, 1808. His wid. Mary, returned to Uxbridge, and m. (2d), Feb. 10, 1814, Dea. STEPHEN BAILEY. Chil. of Rev. Elias and Mary (Spring) Dudley.
 1. *Hannah*, b. Nov. 19, 1794; m. *Luther Bullard*, of Uxbridge. She d. June 7, 1845. Son, Charles H., minister, in Rockville, Conn.
 2. *Otis*, b. Nov. 14, 1796; of Williamsburg, O., with a family.
 3. *John Spring*, b. July 19, 1798; d. in Millbury, Aug. 23, 1816.
 4. dr., d. in infancy. 5. *Elias*, of Cincinnati, O.
 6. *Mary*, d. Aug. 1, 1837, aged 32. 7. dr., d. young.
 [See Hist. Mend. Assn., p. 236.]
-
- p. 450. **STEARNS.**—(Sterne and Sernes, in the early records.) In the distribution of "the farms" or farm lands (situated in Weston), according to an order of the town, passed May 10, 1642, 259 acres were allotted Isaac Sterne, which was a greater lot than was assigned to any others, except John Barnard, who had 287 acres, and John Knight, who had 270 acres. The next greatest was 250 A. to John Bisco; next, 209 to Henry Goldstone; next, 158 to Simon Stone. The farms then granted were not surveyed and plotted out for the grantees until after the lapse of many years. Soon after the grant of the farms above mentioned, a list of possessions in Watertown was made out, wherein it appears that Isaac Sterne, in 1643, held 13 lots, amounting to 471 acres. One lot of 10 A., and another of 60 A., he had recently purchased of Thomaes Ruck, and two of his lots were homestalls. By a deed, dated Jan. 23, 1645-6, he purchased of Thomas Philbrick 6 lots of land, amounting to 113 A.; which, added

to his other possessions, would increase his number of lots to 19, and his number of acres to 584, which would be more lots and more acres than appears to have been then held by any other proprietor. It is supposed that he first settled near Mount Auburn, but that in a few years he moved to a lot on the east side of "the way to Concord," now called Lexington Street, on the west border of Pequasset Meadow. The homestead which he bought of Thomas Philbrick, situated on the N. W. corner of Belmont and Lexington Streets, he gave to his son Samuel, who settled there; and it continued to be occupied by his direct descendants, of the name of Stearns, until after the decease of his great great grandson, Capt. Phineas Stearns, in 1798. Since then it has been held by his descendants of the name of White.

- p. 451. It is stated in the first paragraph, p. 451, that families of the name of Starn and Stern, in the Middle and Southern States, are of German origin. This may be in part correct, especially in Pennsylvania, but not entirely so as to the Carolinas, Georgia, and Tennessee. See [40], pp. 554, and 948.
- p. 453. [9.] John Stearns was town clerk of Billerica two years, and he was one of the Committee on the part of Billerica at the mutual agreement, in 1654, for the separation of Billerica [Shawshin] from Cambridge. In 1658, he was constable. For m. (3d), 1684, read, m. (3d), June 29, 1687.
- [10-3.] In 1675, Samuel Stearns [then aged 16], son of John, of Billerica, d., "was disabled," and the Court ordered that Lieut. French, who had married his mother, should have the charge of him. In April, 1722, the selectmen of Billerica presented a petition to the Court about Samuel Stearns, an impotent and discomposed person, who had been for some time taken care of by Capt. John Stearns and Isaac Stearns, his brethren, 8 acres of land in the centre of the town belonging to Samuel, being in the possession of Isaac, that they (the selectmen) may have the same [land] towards his support. Feb. 24, 1702-3, Mary Mixer gave to her son, Samuel Stearns, 24 poles of land, a share of the estate of her first husband, John Stearns, which had been divided in Oct., 1687.
- [12-2.] Jan. 22, 1710-11, Benjamin Frost and wife Mary, and Rebecca Stearns, sold to George Farley, their father-in-law, all title in the lands of our father, Thomas Stearns, of Billerica.
- [12-3.] Sarah Stearns m., Jan. 1720, Joshua Child [11], first of Wat., where his chil. were born; afterwards of (?) Worcester.
- [Note 1.] Nathaniel and Mary Dunkler were adm. f. c. by Mr. Angier, Aug. 26, 1698. [Nathaniel and Ruth Dunklee had son Nathaniel, b. in Groton, Nov. 27, 1759.]
- p. 454. [18.] Ruth, wife of Samuel Hartwell, Sen., was a dr. of George Wheeler.
- [†23.] Isaac Hartwell. [See Locke Family, p. 35.]
- [†24.] The following is the order of the chil. of Ephraim and Elizabeth (Heywood) Hartwell, after the birth of his 5th child.
6. *Elizabeth*, b. Ap. 28, 1741; m. (1st), Sept. 3, 1764, *Jonas Stratton*, of Concord, b. Sept. 18, 1732, son of Joseph and Rachel. He d. of a casualty in 1774, and she m. (2d), May 24, 1788, Col. *Enoch Putnam*, of Danvers. Chil.,
 1. *Lydia* (Stratton), b. in Concord, June 21, 1769; m. Caleb Campbell, of New Ipswich.
 2. *Jonas* (Stratton), b. Aug. 2, 1771; m., Dec. 5, 1802, *Mary Smith*, of Lincoln.
 7. *Samuel*, b. June 25, 1742, of Lincoln [see p. 454].
 8. *Abigail*, b. June 5, 1744 [see p. 454].
 9. *Ephraim*, b. Jan. 8, 1746; m., June 1, 1769, *Mary Brown* [114].
 10. *John*, b. Aug. 21, 1747 [see p. 454].
 11. *Mary*, b. Jan. 8, 1749.
 12. *Sarah*, b. Aug. 10, 1750.
 13. *Isaac*, b. July 8, 1752.
 14. *Jonas*, b. June 26, 1754.
- [†41.] In 1722, Zachariah Stearns belonged to Capt. Butterfield's Company. Zachariah Stearns was of Merrimack, N. H., in Feb., 1746. Zachariah Stearns, of Groton, aged 45, enlisted in the public service in 1760.
- [†43.] There was an Eleazer [? Ebenezer, 90, p. 463] Stearns, clothier, of Newton, in 1734. Suit in Court, 1732, Eleazer Stearns, of Bedford, vs. Daniel Stearns, of Watertown. Mar. 9, 1741, caution of Littleton against (settlement of) Eleazer Stearns, wife Mary, and 3 chil., William, Eleazer, and Mary, from Concord.
- [21.] Samuel Stearns was selectman 1673, 74, 75, 76, 78, 79, 81, 82. Ap. 16, 1664, Isaac Sternes, and wife Mary, conveyed to their son Samuel "a house where he now lives" [the Philbrick homestead], and other lots of land, with certain reservations. Admin. was granted to his wid. Hannah, Oct. 9, 1683. His Inventory, dated Sept. 28, 1683, by Samuel Stone [his brother-in-law], John Morse [his brother-in-law], William

- Bond, Sen., and John Biscoe, mentions the following real estate: 1. House, 12 acres and orchard [his homestead], £80. 2. 8 A. of upland, and 2 A. of meadow, below Elbow Hill, £40. 3. A lot in lieu of township, £12. 4. 5 A. in Nonesuch meadow, £10. 5. House, barn, 12 A. upland and orchard [his father's homestead], £80. 6. 6 A. meadow, £30. 7. 3 A. salt marsh, £15. 8. 80 A. of dividend land, £60. 9. 15 A. of meadow "at Mr. Samuel's farm" [Samuel Saltonstall], £37.
- p. 455. [1.] For Lieut., read Capt. Capt. John Stearns m. (2d), Ap. 22, 1696. His wife, Joanna, was a witness in Court, June 14, 1726, and was termed a midwife. Farmer says [Hist. of Billerica], "in this town he [Capt. John Stearns] passed his days, and d. Oct. 26, 1728, at the age of 74. His long continuance in several offices, of a civil and military kind, affords a proof of the confidence reposed in him by his fellow-citizens."
- [7.] Abigail Stearns, by W. W., had only two children. She d., and he (W. W.), m. (2d), in Salem, Dec. 3, 1719, Prudence Putnam (a niece of his mother), by whom he had 3. Nehemiah [†10], and other children. [See [1], p. 670, and [43], p. 671.]
- p. 456. [16.] Isaac Stearns m. Elizabeth Stone [22]. In Ap. 3, 1716, he, then of Lex., for £300, sold to John Brooks, of Concord, two lots of land in Lex., viz., 1st. 40 A., bounded N. W. by John Stone; S. W. by Range Way; S. E. by Nathaniel Stone; N. E. by brook, Dea. Samuel Stone, and highway. 2d. 60 acres, bounded N. W. by John Stone and Nathaniel Stone; W. by Capt. Ephraim Flint; S. W. by Gregory Stone; S. E. and S. by Daniel Heard and Dea. Samuel Stone; E. by John Stone. He moved to Stoughton, probably about the time of this sale. Admin. on estate of Isaac Stearns, of Stoughton, was granted to his sons, Simon and Jonathan Stearns, May 22, 1741. His Inventory, £585 2s. 6d., was dated June 25, 1741.
- [20.] Jonathan Stearns m., in Dorchester, May 26, 1727, Experience Linkon (? Lincoln).
- [26.] Caution of Chelmsford, July 24, 1750, against (settlement of) Phebe Stearns, from Littleton. Was this the wid. of Samuel [26]?
- p. 457. [30.] This Samuel Stearns probably went first to New Sherborn (Douglas). In Mid. C. C. P., 1732, suit, Samuel Stearns, of New Sherborn, Worcester Co., vs. Phebe Stearns, wid. of Thomas Stearns, both of Littleton.
- [33.] Rebecca Stearns m. (pub. in Boston, Feb. 7), 1739, Samuel Whittmore.
- [38.] Nathaniel Stearns was Selectman of Wat. 1716. [See White [5], and addition in Part II.]
- [39-1.] Nathaniel Stearns, Jr., bap. Feb., 1736, was probably the one who m., in Concord, Oct. 9, 1760, Mary Farrar ("both of Concord") (?), dr. of Lieut. Jonathan Farrar, who commanded the guard at the North Bridge, in Concord, Ap. 19, 1775.
- [43.] It has not been clearly ascertained whether it was this Isaac Stearns, or Isaac, son of John [25, p. 553], who m., in Camb., Dec. 24, 1725, Mehitabel Frost, and settled in Boston. It was most probably this Isaac, son of Nathaniel. His Inventory, £86 2s. 6d., was dated Jan. 8, 1730-1, and admin. granted to wid. Mehitabel. Chil.,
1. Elizabeth, b. Feb. 12, 1725-6; bap. in First Church of Boston, Jan. 7, 1728; (?) m. in Boston, Nov. 2, 1755, Francis Bourn, Jr.
 2. Mary, b. Sept. 20, (?) 1728, bap. Ap. 1728.
- [46.] Deborah Stearns m. (pub. in Boston, Sept. 15), 1732, Benjamin Salisbury.
- [47.] For Nov. 1, read Ap. 2. Lieut. JOSIAH GREENWOOD, b. June 21, 1709, was a son of John, Esq., and Hannah (Trowbridge) Greenwood, of Newton. [See Ward Family, p. 30, and see Trowbridge [7.]] His wife PHEBE, d. Sept. 17, 1761, and he m. (2d), (covenant dated 1769), wid. PAUDENCE —. Chil.,
1. *Esther*, b. Oct. 7, 1731. 2. *Nathaniel*, b. July 21, 1733.
 3. *John*, b. Dec. 3, 1735. 4. *Sarah*, b. July 6, 1737.
 5. *Alice*, b. Mar. 12, 1739. 6. *Elizabeth*, b. Nov. 21, 1740.
 7. *Phebe*, b. May 20, 1744. 8. *Hannah*, b. June 8, 1746.
 9. *Moses*, b. Aug. 14, 1748. 10. *Nevinson*, b. Oct. 22, 1751.
 11. *Ebenezer*, b. Oct. 1, 1753; m., 1778, *Hannah Winchester*.
- [48.] Lieut. Samuel Stearns was selectman, 1708, 9, 10, 11, 12, 13, 14, 15, 16, 17, 18, 19, 26, 27, 29, 30, 31; Town Clerk, 1708, 9, 10, 11, 15; Town Treasurer, 1710, 11, 12, 13, 15, 16, 17; Moderator of town meeting, 1716. July 8, 1700, the same day that he purchased all right in the estate of Timothy Hawkins, he sold to Daniel Smith and wife Ruhamah, three lots of land, and $\frac{1}{2}$ of a corn-mill on Beaver Brook.
- p. 458. [56.] Capt. Joshua Fuller, of Newton [Fuller, 127, p. 770], m., in Waltham, May 22, 1746 [not May 22, 1748], Anna Stearns. Chil., see p. 770.
- [69.] Hannah (Clarke), wife of Thomas Stearns, was b. Dec. 3, 1719, dr. of William and Hannah (Kee) Clarke, of Newton. [Clarke, [22] and [22-6] p. 742.]

- p. 459. [2.] JOHN STEARNS, Jr., about 1788, at the age of 70, moved to Lovell, Me., and his was the fourth family that settled there. He d. aged 86. Chil.,
1. daughter, m. — *Carter*, of Tewkesbury, Mass.
 2. *Esther*, m. *David Butters*, and settled in Lovell.
 3. *Timothy*, of Lovell, had an only dr., who m. Major *James Kilgore*, of Bartlett, N. H.
 4. *Levi*, of Lovell, had a son, who m. a sister of Solomon Heald, Esq., of Lovell.
 5. *David*. See *ff.*, p. 469.
- [8.] In 1757, Timothy Stearns, of Billerica, belonged to Capt. Thomas Flint's Co., then at Lake George, probably did not go to Bartlett. See [2-3] above.
- [20.] In 1757, Oliver Stearns, of Tewkesbury, was in the same company, d. unm.
- [23.] Isaac Stearns, m., June 14, 1722, Rebecca Randall [not Rachel], dr. &c.
- [27.] For, m., in Stoughton, read, in Dorchester.
- p. 460. [35.] Lewis Stearns, pub. in Boston, Nov. 3, 1805.
- p. 462. [82.] For Pearman, read Boardman. Sept. 11, 1764, caution of Wat. against (settlement of) Stephen Stearns, from Camb., July last.
- p. 463. [198.] (?) Peter Stearns, m., in Wat., Aug. 28, 1782, Dorcas Rice, both of Newton.
- [84.] Mary m. — Frothingham.
- p. 464. [†107-5.] For 1723, read 1823.
- p. 465. [123.] Ruth Stearns m., in Holden, Nov. 26, 1789, Jonas Davis.
- p. 466. [134.] Mar. 8, 1763, caution of Waltham against (settlement of) Hepzibah Stearns, from Westminster, May last (1762).
- [137.] Cornet Josiah Stearns was selectman 1754 and 55. In 1750, he was appointed guardian of his brother Joseph. His 2d wife, Dorothy, d. Oct. 30, 1750.
- p. 467. [159.] JOSEPH STEARNS, m. ANNA PUTNAM. He d. Mar., 1782, leaving two sons. His wid. m. (2d), Peter Nourse, of Danvers, moved to Langdon, N. H., and had 4 drs. She m. (3d), James Campbell, of Ackworth, N. H., and had one dr. Mrs. C., d. about 1844. Chil.,
1. *Benjamin*, b. in Lunenburg, Feb. 27, 1779; a Col., of Langdon, N. H.; m, Ap. 1806, *Bathsheba Egerton*, of Langdon, and had 5 chil. As a citizen he was much respected and beloved. His mind became depressed and deranged, from apprehension of pecuniary embarrassment, and he committed suicide, June 11, 1817. [His wid. m., Dec. 26, 1820, Elisha Garfield, of Langdon, by whom she had 4 chil., 1. *Esther Jane*. 2. *Benjamin Stearns*. 3. *Edmund Holden*. 4. *James Freeman Dana*.] Chil.,
 1. John Walker, b. Sept. 12, 1806; a merchant, of Peru, N. Y.; m., July 12, 1837, *Betsy Maria Eaton*, dr. of Dr. Eaton, of Keesville, N. Y. Chil.,
 1. *James Egerton*. 2. *Francoes*. 3. *Harriet*. 4. *Jane Abigail*.
 5. John Walker. 6. *Woodbury Eaton*.
 2. Willard Egerton, b. May 29, 1808; a gentleman farmer, of Detroit, Mich., unm.
 3. *Abigail Snow*, b. Mar. 16, 1810; m., Ap. 5, 1832, *Luke Putnam*, a horticulturist of Danvers, Mass. Chil.,
 1. John Wells, b. June, 1833; d. soon. 2. *Ann Maria*, b. July 3, 1834.
 4. *Nancy Maria*, b. Ap. 18, 1815; m., in Alstead, Dec. 26, 1839, *Wm. Moore Morrison*, a provision merchant, of Boston.
 5. *Sarah Alexander*, b. Dec. 6, 1817; m., in June, 1842, *Samuel Willard Prouty*, a farmer, of Ackworth.
 2. *Joseph*, b. Dec. 27, 1781; now (1854) of Danvers.
- [160.] (?) Anna Stearns went to Nova Scotia with her mother.
- p. 469. [3-a.] *Betsy Stearns* d. in New Ipswich, Nov. 6, 1854, aged 78, unm.
- [3-f.] Mrs. E. L. (Stearns) Tappan, d. in Conway, N. H., Mar. 27, 1850, leaving dr. *Sarah Salisbury*, b. Nov. 11, 1836.
- [3-g.] Josiah Milton Stearns, entered Amh. Coll., 1838; grad. *Mercersburg Coll. Penn.*, studied at Lane Theol. Sem.; ordained in the Cong. Church, in Lunenburg, Vt., June 6, 1849; d. in Brentwood, N. H., June 12, 1854; m., May 12, 1847. Chil.,
1. *Flora Pierpont*, b. Aug. 17, 1849. 2. *Charles Cummings*, b. Dec. 10, 1852.
 3. *George Milton*, b. Ap. 12, 1854.
- [3-h.] Isaac C. Stearns, of Brooklyn, N. Y., m.
- [3-i.] *Abigail M. Stearns*, m., Oct. 28, 1847, Rev. *Seneca Cummings*, of Antrim, N. H., grad. Dart. Coll., 1844; Missionary, of A. B. C. F. M., at Fuh Chou, China.
- [3-j.] *Lucy Estabrook Stearns*, m., Sept. 6, 1852, Rev. *Charles Hartwell*, of Lincoln, Mass.; Missionary in China.
- [3-k.] John Newton Stearns, of Brooklyn, N. Y., m., Feb. 9, 1854.

- p. 469. [4-a.] WILLIAM STEARNS d. Sept. 29, 1823. His wife BETSEY, was a dr. of Dea. Thaddeus Davis, of Bedford. She d. July 27, 1844. Chil.,
1. *Horatio Davis*, d. Dec. 28, 1803. 2. *Selinda*.
 3. *Matilda Caroline*, d. Jan. 4, 1808.
- p. 470. 4. *William Albert*, m., Ap. 3, 1834, *Clarissa Tarball*, b. Oct. 12, 1810. Chil.,
1. Henry Augustus. 2. Emily Ann. 3. Samuel.
 4. *William Frederick*, b. Mar. 19, 1846.
 5. *Elizabeth E.*
 6. *Charles Blucher*, m. *Mary S. Brooks*. She d. Ap., 1841, and he m. (2d) *Jane Tucker*, of Andover. 3 chil.
 7. *Isaac Davis*, b. July 21, 1821; m. *Mary Adams*, of Ashburnham, dr. of his uncle Timothy Stearns.
- [4-j.] CALLE STEARNS, m., Dec. 20, 1810, JOHN FARRAR, b. Ap. 15, 1784, 2d son of Jacob Farrar, of Concord. Chil.,
1. *Eliza Caroline*, b. Oct. 21, 1811; m., June 25, 1825, *Oliver Brooks*.
 2. *George*, b. Oct. 3, 1813; m., June 5, 1838, *Sophronia M. George*.
 3. *Charlotte*, b. Nov. 27, 1816; m., Ap. 4, 1840, *Henry Tuckerman*.
 4. *Roxana*, b. Ap. 18, 1821; m., Ap. 21, 1842, *Abraham Bowden*.
 5. *Maria*, b. Sept. 16, 1823; m., Aug. 28, 1845, *Ezekiel Bartlett*.
 6. *Susan*, b. June 24, 1826; m., Sept. 20, 1846, *Elihalet S. Wood*.
 7. *Lydia*, b. Sept. 28, 1828. 8. *Calle*, b. Oct. 8, 1830.
- [4-m.] For Reid, read Rice.
- [8.] Wid. Sarah Stearns, d. in Billerica, Dec. 10, 1851, aged 93.
- p. 471. [8-a.] Sewall Stearns, Esq., d. Oct. 31, 1849.
- [8-b.] Obed, a farmer. His 3d child, Eckley Washington, b. Oct. 9, 1835.
- [8-c.] Sarah Stearns was, for several years before marriage, the Principal of a large Female Seminary in Chillicothe, O. [See Lawrence [582.] p. 843.]
- [8-d.] Eckley Stearns, m., Sept. 11, 1831, Hannah Pratt, of Weymouth, s. p.
- [8-e.] Timothy Stearns, after he left college, studied Theology at Andover; after that, was Assistant one year in his sister Sarah's seminary at Chillicothe; after that was Principal of the High School in Columbus, O. He m., Dec. 13, 1837, Catherine Taylor, of Athens, O. 2 chil.
- p. 471. [9.] JOHN STEARNS, a farmer, of Billerica, m. (1st), Feb. 10, 1801, MARY LANE, b. Aug. 15, 1776, dr. of Samuel Lane, of Bedford. She d. Nov. 30, 1815, and he m. (2d), May 13, 1817, SUSANNA WINN, b. Nov. 2, 1771, dr. of Joseph Winn, of Burlington, Mass. She d. Jan. 28, 1842. He was killed Nov. 5, 1836, by a locomotive on the Boston and Lowell R. R., in Woburn, where he was then residing. Chil.,
1. *Franklin*, b. Jan. 25, 1802; a farmer, of Billerica; m., Dec. 28, 1828, *Sally Lane*, b. Dec. 18, 1801, dr. of Benjamin Lane, of Ashburnham. Chil.,
 1. Susan Isabel, b. in Bedford, Mass., May 21, 1830.
 2. Mary Jane, b. in Bedford, Mar. 22, 1832.
 3. Sarah Olive, b. in Billerica, Mar. 23, 1834; d. May 23, 1838.
 4. Sarah Maria, b. in Billerica, Ap. 17, 1838.
 5. Lucretia Ann, b. Jan. 25, 1842. 6. John Billings, b. Feb. 13, 1845.
 2. *Mary*, b. Dec. 28, 1803; of Billerica; m., May 13, 1832, *William Whitford*, b. Oct. 5, 1799, son of William Whitford, of Hillsboro, N. H. Chil.,
 1. John Stearns b. May 22, 1833. 2. Edward Lorenzo, b. July 28, 1836.
 3. Mary Eliza, b. Ap. 18, 1838. 4. Francis Oliver, b. Ap. 21, 1843.
 5. Emma Maria, b. Feb. 13, 1845. 6. Addison Bernard, b. Ap. 29, 1847.
 3. *John Owen*, b. Ap. 13, 1805; of Elizabethtown, N. J.; a director and super't of the Central R. R., of New Jersey; m., Ap. 5, 1842, *Margaret C. Walker*, b. Oct. 9, 1821, dr. of William Walker, of Rehoboth, Great Valley, Chester Co., Penn., who m. Sarah, dr. of Rev. Mathias Pennypacker, of Valley Forge, Chester Co., Penn. Chil.,
 1. Mary Athalia, b. Dec. 30, 1842. 2. Annie Augusta, b. Ap. 22, 1844.
 3. William Walker, b. Oct. 9, 1845. 4. Emma J., b. Oct. 23, 1847.
 5. John Onslow, b. Aug. 24, 1849. 6. Herbert Pegram, b. May 30, 1851.
 7. Matilda M., b. June 8, 1853.
 4. *Onslow*, b. Feb. 2, 1807; d. Feb. 23, 1808.
 5. *Eliza Ann*, b. Oct. 4, 1808; m., May 17, 1832, *John Dennis Billings*, b. Nov. 10, 1805, son of John Billings, of Lincoln, Mass. Chil.,

1. Mary Ann, b. in Bedford, Mass., Mar. 18, 1833; m., Ap. 28, 1853, Oliver Josiah Lane, son of Oliver Lane, of Bedford, Mass.
 2. John Winn, b. Jan. 16, 1837; d. Jan. 9, 1840.
 6. Charles Onslow, b. Aug. 30, 1810; of Concord, N. H.; President and Ag't of the Northern R. R., of N. Hampshire; m., June 26, 1845, *Mary Abbott Holbrook*, b. Mar. 10, 1819, dr. of Adin Holbrook, then of Athol, Mass., afterwards of Keene, N. H., now of Lowell, Mass.
 1. Charles Onslow, b. May 31, 1846.
 2. Mary Laurinda, b. Ap. 2, 1849.
 7. *Lorenzo*, b. May 13, 1813; d. at Elizabethtown, N. J., May 13, 1836.
 8. *Bernard*, b. Nov. 23, 1815; now of N. York city; m., Dec. 30, 1851, *Lavinia B. Haines*, b. in N. York, Jan. 29, 1830, dr. of Simeon Haines, formerly of Haddonfield, N. J.
- [10.] For Abiel, read Obed, who was a physician, of Hampton, N. H., and d. 1800, much esteemed and respected.
- [11.] After retreat, insert).
- [14-c.] Polly, wid. of Moses Fitch, m. (2d) Ebenezer Brown, of Mich.
- p. 472. [16-a.] For 1827, read 1837.
- [16-d.] For William Buttrick, read Willard. Chil.,
1. Oliver Davis.
 2. Mary Alice.
 3. Harriet Ann, d. Sept. 30, 1852.
 4. Eliza Kinsman.
- p. 473. First line, for Duell, read Dwella. 3d line, for Nesson, read Nelson.
- [17-c.] Edward Harrison Stearns, is Sec. and Treas. of Western Home and Foreign Mission Association.
- [18.] For Bradford, read Bedford.
- [19-a.] Rev. Edward Josiah Stearns, is now, or was lately, Prof. of Modern Languages and History, in St. John's College, Annapolis, Md.
- [20.] For Cobb, read Cole.
- [20-a.] For Elizabeth, read Elbridge. [See Locke Family, p. 70.]
- [20-b.] For Weston, read Preston.
- p. 474. Rev. Samuel Ruggles, of Billerica, m., in Rox., Ap. 18, 1727, Elizabeth Williams, b. Jan. 12, 1692, dr. of Samuel and Deborah (Scarborough) Williams, granddr. of Samuel and Sarah (May) Williams; great granddr. of Samuel and Theoda (Park) Williams, and great great granddr. of Robert and Elizabeth (Stratton) Williams, of Roxbury, the progenitors of a very numerous and respectable race.
- [22-c.] For Ashton, read Acton.
- p. 475. [22-g-1.] Chil. of *Henry and Sarah Elizabeth (Lane) Goodwin*:
1. Henry Oliver, b. June 25, 1839.
 2. Francis Uriah, b. July 4, 1841.
 3. Charles Wellington, b. Sept. 4, 1843.
 4. Joseph Augustus, b. Oct. 31, 1845.
 5. George Edwin, b. Ap. 13, 1847.
- [22-g-2.] Chil. of *George D. and Mary Whiting (Lane) Briggs*:
1. Ann Catherine, b. and d. July 4, 1842.
 2. Geo. Wellington, b. June 22, 1843.
 3. Ann Catherine, b. Jan. 9, 1846.
 4. Mary Ellen, b. Oct. 1849.
- [22-g-3.] Mary P., wife of Wm. Augustus Lane, d. Sept. 20, 1852, and he m. (2d), Mar. 20, 1853, Julia M. Houghton, of Northfield.
- [22-g-4.] Catherine Amelia Lane, m. Joseph Goodwin.
- [22-g-5.] Abigail Rebecca Lane m. Samuel Stearns Wilson, Principal of a grammar school in Charlestown.
- [22-g-6.] Oliver Josiah Lane m., Ap. 28, 1853, Mary A. Billings.
- [22-h.] Abigail French Lane d. July, 1800.
- p. 478. [ii.] Bryant Stearns, Esq., bequeathed \$2800 for charitable purposes.
- [25-c-3-3.] Perley Ray Lovejoy, Prof. in Newton Univ., Baltimore.
- [26 b.] Mary Bryant Stearns m. Charles Blaisdell, of Epping.
- p. 479. [27-c.] Rev. FOREST JEFFORDS, b. Aug. 4, 1794, son of Samuel Jeffords, of Wells, Me.; grad. at Bangor Classical and Theol. Seminary, 1825; ordained in Epping, N.H., Oct. 26, 1826; dismissed, Oct. 31, 1831; installed in Middleton, Mass., May 2, 1832, resigned, May 15, 1844. He m. SARAH CAROLINE STEARNS. Chil.
1. *Abigail Jane*, b. June 29, 1828; m., Nov. 22, 1849, *Augustus G. Colby*, of Springfield, Mass.
 2. *Sarah Caroline*, b. Feb. 6, 1830.
 3. *Samuel Stearns*, b. Nov. 15, 1832.
 4. *Olive Maria*, b. Oct. 7, 1834.
 5. *Elizabeth Sperry*, b. Aug. 31, 1836.
 6. *William Reed*, b. May 19, 1838.
 7. *Jonathan Forest*, b. June 20, 1839.
 8. *Charlotte Leavitt*, b. Aug. 17, 1840.
 9. *Josiah Atherton*, b. Sept. 16, 1843.
- [27-d.] Rev. WILLIAM A. STEARNS, overseer of Harv. Coll.; D.D. 1853; inaugurated Pres. Amh. Coll. Nov. 22, 1854. His wife, b. 1803, was a dr. of Samuel Alden and

- Abigail (Drew) Frazer, and a gr. dr. of Capt. Thomas and Rebecca (Alden) Frazer, of Duxbury. Chil.,
5. *Rebecca Frances*, b. Sept. 27, 1847.
 6. *Winifred Alden*, b. July 13, 1852.
- [27-f.] Rev. JONATHAN F. STEARNS, D.D., was ordained, in Newburyport, Sept. 16, 1835, and installed in the First Presbyterian Church in Newark, N. J., Dec. 13, 1849. He m., Nov. 15, 1843, ANNA S. PRENTISS, of Portland. Chil.,
1. *Sergeant Prentiss*, b. Nov. 20, 1844.
 2. *Lewis French*, b. Mar. 10, 1847.
 3. *Ann Prentiss*, b. June 27, 1853.
- [27-g.] Chil. of Dea. CHARLES and ELIZABETH W. (Stearns) JAMES:
1. *George Edwin*, b. Sept. 25, 1832.
 2. *Lyman*, b. Aug. 9, 1834.
 3. *Mary Elizabeth*, b. May 7, 1836.
 4. *Charles Waldron*, b. Sept. 22, 1842; d. 5. *Harrison Webster*, b. Nov. 12, 1852.
- [27-i.] Chil. of Rev. JONATHAN and CHARLOTTE E. (Stearns) LEAVITT,
1. *Edward Chalmers*, b. Mar. 9, 1842.
 2. *Charlotte Elizabeth*, b. Mar. 4, 1848.
- [28.] Timothy Stearns was a school-teacher.
- [29.] For Samuel Howe, read Lemuel.
- p. 480. [44.] Bette Stearns m. Abijah Wyman. [See Wyman [27], p. 670.]
- [60-a-1.] Emma Hobart Stearns m., July 16, 1851, Charles Wright.
- p. 481. [64.] For 24 yrs., read 35 yrs. Nathan Stearns enlisted in Capt. Cox's Co., Mar. 18, 1760.
- [64-b.] The newspaper which Mr. Stearns published was called The Providence Free Press, and it was devoted to anti-slavery and anti-freemasonry.
- [64-d-1.] For Waldrow, read Waldron, and for 18, read 8.
- p. 482. First line, for Me., read Mass.
- [65-s.] For Le Roy, read La Roy.
- p. 483. [87.] This is supposed to be the Peter Stearns who belonged to Lieut. Fr. Miller's Co., in Mar. and Ap., 1762.
- p. 485. [125.] For M. B. 1791, read 1797.
- p. 486. [126.] Dr. Asahel Stearns resigned his professorship in 1829.
- p. 489. [131-e.] Luther Stearns m., in Holyoke, June 10, 1851, Mary Alvord.
- p. 494. [181-a.] EPHRAIM STEARNS m., Feb. 11, 1824, LUCY WILLARD, b. in Athol, July 19, 1798. He has resided successively in Montague, where he was a major and selectman, in Templeton, Ashburnham, and Rindge, N. H. Chil.,
1. *Ephraim Lincoln*, b. in Montague, Feb. 23, 1825; is a R.R. engineer.
 2. *Samuel Clinton*, b. in M., Ap. 11, 1827; a tailor, of Rutland; unm.
 3. *Lucy Jane*, b. in M., Jan. 10, 1830; m., Dec. 25, 1849, — *Fisher*, of Ashburnham.
 4. *Helen Augusta*; and 5. *Henry Augustus* (twins), b. in M., Sept. 24, 1832.
 6. *Herman Dwight*, b. in M., Jan. 9, 1836.
 7. *Albert Clement*, b. in Ashburnham, Aug. 23, 1840.
 8. *Mary E.*, b. 3, d. 8 Ap., 1843, in Templeton.
 9. *James W.*, b. in Rindge, May 11, 1844, d. Jan. 23, 1845.
 10. *Clarence O.*, b. in R., Ap. 23, 1847, d. Jan. 21, 1849.
- p. 496. [197-b-2.] Charles Edwin, son of Col. Edwin Stearns, d. of consumption, July 15, 1853.
- p. 497. [199-b-3.] James Stearns m., Sept. 10, 1850, Ann Augusta Pond, b. Mar. 4, 1828, dr. of Samuel Pond, Esq., of Cambridgeport.
- [199-e.] Samuel Stearns d. Sept., 1850.
- [199-f.] Marshal Stearns has, 10. Julia Medora, b. Sept. 22, 1851.
- [199-h.] Thomas Stearns has, 8. Hannah Maria, b. Aug. 2, 1849. 9. Abigail Henrietta, b. Oct. 17, 1851.
- p. 498. [206-e.] Horatio Brown d. on a voyage to California, in Dec. 1852.
- p. 499. [209.] Silas Stearns m., in Lincoln, Oct. 30, 1765. He d. Dec. 31, 1804, and his wid. Elizabeth d. 1824, aged 84. In 1757, he marched from Waltham to Springfield, in Capt. Seth Blodgett's Co.
- [211.] William, m. Melissa Estabrook, of Lex., and d. 1844, s. p.
- [212.] Strike out all after 1770, and insert, m., Dec. 18, 1794, Seth Hall, of Harwick. They settled in Mount Vernon, Me. One child. Elizabeth, m. — Rollins.
- [214.] Wm. and Eunice (Stearns) Hyde, settled in Hubbardston.
- [214½.] Isaac perished in a conflagration.
- [215.] Kezia, now (1853) of Concord, unm.
- [216.] Elijah Stearns, a cabinet-maker, m. Mary Osgood Greene, who d. in Brooklyn, N. Y., Aug. 29, 1849. 5 chil.

[217.] SILAS STEARNS, Jr., served an apprenticeship with James H. Foster, an upholsterer, of Boston. In the autumn of 1802, then aged 18, he became a member of the First Baptist Church in Boston, then under the pastoral care of Rev. Dr. Stillman. He soon turned his attention earnestly to a preparation for the Gospel ministry, but completed the term of his apprenticeship. Soon after this, he began to study with Rev. Mr. Williams, of Wrentham, Mass., and afterwards with Rev. Dr. Greene, of North Yarmouth, Me. In the spring of 1806, he was licensed to preach, and was ordained at N. Yarmouth, Oct. 1807. He was soon settled in Freeport, where he remained about two years. He was installed the first pastor of the First Baptist Church in Bath, Me., Dec. 6, 1810, which office he held until his decease, Aug. 1, 1840. He had acquired a good knowledge of the Hebrew, Greek, and Latin languages; was much devoted to the cause of education; was a trustee and one of the earliest founders of Waterville College. He m. (1st), Nov. 30, 1815, HANNAH OAKMAN SPRAGUE, dr. of Ebed and Abigail (Tufts) Sprague, of Boston. She d. Sept. 20, 1824, aged 38, and he m. (2d), Jan. 5, 1826, MARY LUNT, dr. of Joseph and Priscilla Lunt, of Litchfield, Me. Chil.,

1. OAKMAN SPRAGUE, b. Oct. 26, 1817; grad. Waterville Coll. 1840; at Newton Theol. Sem. 1846; was ordained in the Central Baptist Church of Southbridge, Mass., May 19, 1847. He m. (1st), June 8, 1847, ANNA JUDSON GRATTON, of Providence, R. I. He m. (2d), Dec. 2, 1850, HANNAH JANE BEECHER.
(By 2d wife.)
2. WILLIAM BRADFORD, b. Aug. 27, 1826; of Bath; m., Feb. 10, 1852, LUCY WHITTEMORE POTTER, dr. of David and Margaret Potter, of Bath.
3. MARY HOMER, b. Sept. 22, 1828; m., Oct. 14, 1848, JAMES D. RIVERS, of Gainesville, Ga.
4. ISAIAH WELLINGTON, b. May 28, 1831.
5. SILAS BALDWIN, b. Mar. 7, 1833, d. Ap. 26, 1834.
6. ELIZA WALDRON, b. Sept. 5, 1835, d. June 25, 1839.
7. SARAH COMINGS, b. July 27, 1837.

[219.] Isaac Hastings was born, Dec. 26, 1755. For the parentage of this Isaac Hastings, and a more full account of his family, see Hastings [52], p. 790.

p. 500. [223.] Mrs. Susanna (Stearns) Wyeth, d. Mar. 28, 1855, aged 80 y., 8 m.

p. 501. [227.] For Sept. 22, read Sept. 21.

p. 503. [242-a.] Horatio Stearns, a carpenter, m., in Acton, June 5, 1851, Ann Goward.

p. 505. [259.] JOSEPH B. SPRAGUE, Esq., studied law with Hon. William Prescott, then of Salem, and settled in Salem, his native town. After practising law a short time, he became an ardent politician of the democratic party, but was more devoted to aid other aspiring politicians, than to the seeking office for himself. He was an intimate friend of Judge Story, a friend and correspondent of J. Q. Adams, and for a long time a very influential leader of the democratic party of that State. His political writings were numerous. He was U. S. Dep. Marshal under Mr. Jefferson, and Postmaster from 1815 to 1829; was Rep. 3 years in the State Legislature, a State Senator, and a member of the Governor's Council. In 1811, he was appointed clerk of the County Court by Governor Gerry, which office he held only a short time. In 1830, he succeeded his father-in-law (Hon. B. Bartlett), as High Sheriff of Essex County, and held the office until Nov., 1851. He m. (1st), Aug. 31, 1808, ELIZA BARTLETT, 2d dr. of Hon. Bailey Bartlett, of Haverhill. She d. Ap. 16, 1817, and he m. (2d), May 13, 1819, Sarah Leonard Bartlett, sister of his first wife. [See [444.] p. 900.] He d. Feb. 22, 1852, and his wid. resides in Salem. See Salem Register of Feb. 26, 1852. Chil.,

1. WILLIAM HARRIS, b. May 6, 1809, d. Aug. 30, 1812.
2. ELIZA BARTLETT, b. Oct. 1, 1810; m., Sept. 9, 1835, Dr. MALTBY STRONG, b. Nov. 24, 1797; of Rochester, N. Y., s. p.
3. WILLIAM HARRIS, b. Ap. 24, d. Aug. 14, 1813.
4. EDWIN LE BARRON, b. at Salem, July 21, 1814, burnt to death by the carelessness of his nurse, Feb. 13, 1816.
5. WILLIAM EDWIN, b. and d. Feb. 12, 1817.
(By 2d wife.)
6. HARRIET LEONARD, b. Nov. 23, 1822; of Salem, unm.
7. WILLIAM JARVIS, b. Jan. 23, d. July 26, 1826.

8. CAROLINE LOUISA, b. June 21, 1827; m., Dec. 6, 1849, Rev. CHARLES SMITH, Jr., b. Aug. 16, 1818 [son of Charles and Alithea Smith], grad. Amh. Coll.; afterwards at Andover Theol. Sem.; settled first in Warren, Mass., afterwards in "The Old South Church," in Andover, Mass., and now (1854), pastor of Shawmut Church, Boston, Chil.,
1. Edward Bartlett, b. Feb. 27, 1851.
9. JOSEPH WHITE, b. Jan. 18, 1831; grad. Harv. Coll. 1852; now (1853), engaged in scientific pursuits, in the Lawrence Scientific School, of Harv. College.
- [265.] Caroline Stearns d. in Salem, Nov. 13, 1851.
- p. 506. [273.] For Zephaniah, read Zephaniah.
- [283.] Elizabeth m. — Adams.
- p. 507. [286.] Abigail Stearns m. Isaac Gibson, of Grafton.
- p. 512. [314.] For 1791, read 1792. For Hall, read Holt.
- p. 513. [317.] Mrs. Thankful B. Stearns d. Feb. 3, 1853. For 1791, read 1792.
- p. 515. [323.] Capt. Phinehas Stearns was a Lieut. under Capt. Samuel Barnard at the Lex. alarm, and was selectman 1783, 84, 85. It was probably Phinehas Stearns [218, p. 499], who was at Lake George, in 1757.
- p. 517. [329.] Mary Low, who m. David Stearns, Jr., was born in Ipswich, Jan. 11, 1740, dr. of Jonathan and Sarah, who moved to Lunenburg. By her 2d husband (J. E.), she had, 1. Samuel F., and 2. Thomas S. (twins), b. Aug. 24, 1777. 3. Mary, b. Sept. 19, 1779. 4. Samuel, b. May 13, 1781.
- p. 519. [364.] Dr. Josiah Stearns Hurd, of Charlestown, d. Mar. 25, 1855.
- [365.] This was probably the Jonas Stearns who belonged to the company of Capt. Bezaleel Eager, of Westboro, in 1757.
- p. 520. [390.] Sarah Stearns m., in 1795, Edmund Lawrence. [See [890], p. 850, where for Mary should be read Sarah.]
- p. 521. [4.] Sarah, wid. of Edward Converse, m. (2d), in Wob., Jan. 14, 1697, Ebenezer Hill.
- p. 523. [53.] Chary, wife of Jonathan Stone, survived him, and was admin'x.
- [60.] Mar. 23, 1762, caution by Wat. against (settlement of) JOSIAH STONE, wife ABIGAIL, and 4 chil., *Abigail, Elizabeth, Josiah, and Richard*, from Lex. Ap. last.
- [64.] ROBERT and ANNA (Stone) MUNROE, had, 5. Robert, b. Jan. 25, 1746 (? 44). 6. John, b. June 15, 1748; m., Dec. 17, 1772, *Rebecca Wellington* [87].
- [64-4.] After Smith, insert [86.]
- p. 525. [103.] See Hist. of Mendon Association, p. 105.

MANNING.—[The Mannings were not a Watertown Family, but were intimately allied to them, as may be seen p. 528. The following is inserted as an addition to the Appendix, p. 527.]

- p. 528 [5.] SARAH MANNING, m., Ap. 11, 1671, Capt. JOSEPH BULL, a mariner, of Hartford, son of Thomas and Susanna Bull, of Hartford. She d. soon, leaving a dr. SARAH, who d. soon.
- 1 [7.] MARY MANNING, m., Oct. 21, 1674, Rev. WILLIAM ADAMS, grad. Harv. Coll. 1671, ordained in Dedham, Dec. 3, 1673. 3 chil. She d. June 24, 1679. He m. (2d), Mar. 29, 1680, ALICE BRADFORD, dr. of Major William and Alice (Richards) Bradford, and a granddr. of Gov. William Bradford. He d. Aug. 17, 1685, and his wid. m. Major James Fitch, of Norwich, who d. in Canterbury, Conn., in 1727, aged 80. [See Mass. Hist. Coll., 4th Ser. I., pp. 5-49; also, Caulkins's Hist. of New London, Index; also, Geneal. Reg. iv. p. 45, and IX., p. 127.]
- (Chil. of Rev. William and Mary (Manning) Adams.)
1. MARY, b. Nov. 12, 1675, d. Ap. 13, 1676.
- 7.2 2. ELIPHALET, b. Mar. 26, 1677, grad. Harv. Coll. 1694.
3. WILLIAM, b. Jan. 17, 1678-9, d. Aug. 15, 1679.
- (Chil. by 2d wife, Alice, not of the Manning lineage.)
- 3 4. ELIZABETH, b. Feb. 23, 1680-1; m. (1st), Sept. 4, 1696, Rev. SAMUEL WHITING, of Windham, Conn. 13 chil.; several of them highly distinguished. He d. in 1725, and his wid. m., in 1737, Rev. SAMUEL NILES, of Braintree, grad. Harv. Coll. 1699, d. 1759. She d. in New Haven in 1760.
- 4 5. ALICE, b. Ap. 3, 1682; m. Feb. 19, 1701, Rev. NATHANIEL COLLINS, grad. Harv.

- Coll. 1697, d. 1756, the first minister of Enfield, Conn. She d. Feb. 19, 1735. [See General Reg. ix., p. 127.]
- 5 6. WILLIAM, b. Dec. 17, 1683; in 1699, helplessly infirm.
- 6 7. ABIEL (Abiah), b. Dec. 15, 1685; posthumous; m., about 1707, Rev. JOSEPH METCALF, b. in Dedham, 1682, grad. Harv. Coll. 1703; minister of Falmouth. 11 chil. He d. May 24, 1723, and his wid. m. Rev. Isaac Chauncey, of Hadley, grad. Harv. Coll. 1693, d. 1745. [For her children and descendants, see Gen. Reg. ix., p. 127.]
-
2. 7 Rev. ELIPHALET ADAMS was ordained in New London, Feb. 9, 1708-9 (as successor of Rev. Gurdon Saltonstall, who had been elected Governor of Connecticut); in 1723 was elected President of Yale College, but declined the office. He m., Dec. 15, 1709, LYDIA PYGAN. [See Danforth, p. 752.] She d. Sept. 6, 1749, aged 62, and he m. (2d) ELIZABETH WASS, of Boston. He d. Oct. 4, 1753, and his wid. returned to Boston. Chil.,
- 8 1. WILLIAM, b. Oct. 7, 1710; grad. Yale Coll. 1730; tutor 1732-4; was a preacher in various places for 60 years, but never ordained; d. in New London, 1798, unm.
- 9 2. PYGAN, b. Mar. 27, 1712; a Justice of the Peace; a goldsmith by trade, but actively engaged in commerce. He m., June 7, 1744, ANNE RICHARDS, b. Sept. 18, 1728, dr. of John Richards, Esq. He d. abroad, in July, 1776, and his wid. d. Jan. 8, 1809. Chil.,
- 10 1. William Adams, b. Nov. 20, 1745; d. at St. Pierre, Martinique, Ap. 4, 1778, unm.
- 11 2. Alexander Pygan, b. Sept. 6, 1747, lost at sea in 1784, unm.
- 12 3. Anne, b. Ap. 30, 1749; m., May 5, 1768, John Champin. 14 chil. The family moved to Baltimore, where he d., June 17, 1800, and his wid. d. Ap. 6, 1838, aged 89.
- 13 4. Lydia, b. and d. 1751.
- 13 5. Elizabeth, b. Dec. 21, 1752; m., Oct. 19, 1775, Thomas Pool, Esq., son of John and Sarah Pool, of Raritan, N. J. He d. Jan. 26, 1828, aged 75, and his wid. d. Oct. 21, 1845, aged 93. Chil.,
- 14 1. William Adams, b. May 7, 1777, d. Sept. 22, 1795.
- 15 2. Sally Field, b. Feb. 22, 1780; m. Jan. 4, 1798, Samuel Green, Esq., editor of the London Gazette. She d. Mar. 10, 1801, leaving one son, who d. unm.
- 3 and 4. two drs., d. in infancy.
- 16 6. Lydia, b. July 19, 1757; m., Sept. 17, 1779, Robert Hallam, Esq. He d. Feb. 18, 1835, aged 78, and his wid. d. Oct. 29, 1845, aged 88. Rev. Robert A. Hallam, grad. Yale Coll. 1827; Rector of St. James's Church, of New London, is a descendant.
- 17 7. Thomas, b. Jan. 5, 1761, d. at St. Martin's, Sept. 8, 1815, unm.
- 18 3. MARY, b. Mar. 5, 1713-14; m. (1st), Nov. 13, 1733, Dr. JONATHAN GARDNER, son of John Gardner, Esq., of Gardner's Island (Isle of Wight). He d., lost at sea, in 1735, leaving one son. She m. (2d), Oct. 29, 1738, Hon. JOHN BULKLEY, Esq., an eminent jurist, of Colchester, grad. Yale Coll. 1726, son of Rev. John and Patience (Prentice) Bulkley, of Colchester, and grandson of Rev. Gershom and Sarah (Chauncey) Bulkley, of Wethersfield. She d. Jan. 24, 1749-50, and he d. July 21, 1753, aged 49. [See Hinman, pp. 382-3.] Chil.,
- 19 1. John (Gardner), b. Oct. 7, 1734, of New London; m. Sarah, dr. of Edward Palmes. He d., leaving 3 drs. One of them, Sarah, m., Dec. 10, 1783, Hon. Jeremiah Gates Brainerd, grad. Yale Coll. 1779. Their 4th and youngest child was John Gardner Brainerd, the poet, b. Oct. 21, 1796, grad. Yale Coll. 1815, d. 1828, unm.
- 20 2. Lydia (Bulkley), bap. Oct. 28, 1739; m., in 1761, Capt. Robert Latimer, who was soon after lost at sea, leaving one child. His wid. d. in 1782.
- 21 1. Robert, b. 1762; a mariner, of Middletown, where he m., in 1784, Hannah Sage. He was lost at sea in 1797. Chil.,
- 22 1. Harriet B., m., in 1808, Milo Cook, of Middlebury, Vt.
- 23 2. Maria S., m. Rev. Joshua Bates, grad. Harv. Coll. 1800; D.D. Yale, 1818; Pres. of Mid. Coll., afterwards of Dudley, Mass.; d. 1854.
- 24 3. Michael B., d. in Charleston, S. C., in 1819, unm.

- 25 4. Eliza S, m. Robert Bridges Patten, grad. Yale Coll. 1817; P.D. Gott.; Prof. of Greek and Latin successively in Mid. Coll., Nassau Hall, and N. Y. Univ.
- 26 3. *Mary (Bulkley)*, b. May 23, 1741; m. *George B. Hurlbut*, s. p.
- 27 4. *Elisphaet (Bulkley)*, bap. Aug. 10, 1746; a captain in the Revolution; afterwards a Colonel; m. *Ann Bulkley*, his cousin, dr. of Major Charles Bulkley. 4 sons and 6 ds. b. in New London. The family moved to Wilkesbarre, Penn., where he d., aged 80.
- 28 5. *Lucy (Bulkley)*, bap. Aug. 27, 1749; m. Capt. *John Lamb*, of Groton, Conn. One child, viz.,
- 29 1. *Henry F. (Lamb)*, a colonel, of Wilkesbarre; m. *Frances*, dr. of his unole, Col. E. Bulkley.
- 30 4. THOMAS, bap. Jan. 4, 1715-16; grad. Yale Coll. 1737; was a physician; d. 1758, s. p.
5. SAMUEL, b. Aug. 11, 1717; d. aged 5 months.
6. LYDIA, b. Feb. 20, 1720, d. July 17, 1721.
- [11-8.] Strike out all after 1705. Joseph Manning, who grad. H. C. 1725, was a son of Thomas, of Ipswich. He d. in Woburn, May 8, 1784.
- p. 529. [24.] Dr. SAMUEL MANNING, Jr., m., Sept. 29, 1801, LUCY COGSWELL, b. Nov. 5, 1778, d. Oct. 3, 1817. [See p. 529.] Chil.,
-
1. SAMUEL, b. July 6, 1802; grad. Harv. Coll. 1822; of Baltimore; m., June 10, 1829, SUSAN SHEPARD, dr. of Thomas Sheppard, of Baltimore. Chil.,
1. *Lucy Ann*, b. June 14, 1830. 2. *Samuel*, b. Mar. 1832. 3. *Wm. Sheppard*. 4. *James Buchanan*, b. Sept. 25, 1835, d. soon. 5. *Thomas Sheppard*. 6. *Susan Sheppard*, b. Aug. 8, 1839. 7. *Betsy Mosher*, b. May, 1841.
2. MARY WOOD, b. July 29, 1806; m., July 26, 1838, Dr. ANTHONY BENEZET CLEVELAND, then of Baltimore, afterwards of Cambridge, where he d., Nov. 28, 1852, aged 62. Chil.,
1. *Wm. Charles*, b. July 5, 1839. 2. *Lucy Elizabeth*, b. May 27, d. June 8, 1842. 3. *Clement*, b. Sept. 29, 1843. 4. *Mary Manning*, b. Oct. 11, 1846.
3. WILLIAM, b. Aug. 26, 1808; a physician; m., in 1837, HEPZIBAH HOWARD, of Dearbornville, Mich. Chil.,
1. *Mary Elizabeth*, b. 1838. 2. *Charles Green*. 3. *Rebecca Pratt*, b. Feb., 1847. 4. *Joseph Howard*, b. 1848.
4. JOSEPH COGSWELL, b. Sept. 13, 1812; of Baltimore; m., Aug. 24, 1841, REBECCA PARKMAN JARVIS LIVERMORE [Livermore, 220]. Chil.,
1. *Mary Elizabeth*, b. Aug. 1842. 2. *Charles Henry*, b. June, 1844. 3. son, d. of a casualty, aged 10 mos. 4. *Joseph Cogswell*, b. July, 1847. 5. *Rebecca*, b. July, 1849. 6. *Mary Livermore*.
5. REBECCA PRATT, b. Ap. 14, 1814, d. July 29, 1816.
6. CHARLES PRATT, b. Feb. 13, 1817; of Baltimore; m., Ap., 1850, MARY JEANETTE THRUSTON, of Cumberland, Md.
1. *Julia Thruston*. 2. *Mary Jeanette*.
- [30.] For Samuel, read William, who d. in Camb., July 25, 1849, aged 82.
- [31.] For Joseph Warland, read John Warland.
- [33.] JOHN BARROWS, grad. Harv. Coll. 1766; was a great mathematician; a school-master, of Dighton, d. 1816. Chil.,
1. *John*, of Troy, N. Y. 2. *Thomas*, a physician, of Providence, R. I. 3. *David*. 4. *Sarah*, m. — *Waldron*.
- p. 530. [30.] For Eaton, Mass., read Easton.
- p. 532. Bellows' [1.] Jo. (John) Bellows, aged 12 years, embarked in the Hopewell, Wm. Burdock, master, for New England, Ap., 1635. For m. in Marlboro, read, m. in Concord. [See "Historical Sketch of Col. Benjamin Bellows," by Rev. H. W. Bellows, published in 1855.]
- p. 535. [57.] *Mary H.*, wid. of Col. C. B., d. July 11, 1846. [58.] Ephraim H. Bellows was living in Charlestown in 1852.
- p. 536. [82-5.] Rebekah m. John S. Wells.
- p. 538. [115.] Henry A. Bellows, Esq., now (1855) of Concord, N. H. [117.] William J. Bellows, Esq., now (1855) of Concord, N. H. [1204.] For Harriet Z., read Harriet L.
- p. 539. [135.] For Daniel Buffum, read David. [137.] For Peet, read Peck.

- p. 548. [10.] Dr. John Hosmer m. (2d) Lydia Robbins.
 p. 550. [12.] Henry Stearns Newcomb, grad. Dart. Coll., 1807; A.B. Harv. Coll., 1808.
 p. 552. [19-8.] For Charlotte, read Charlotte Jane.

CHARLES STEARNS.—[1.] The land bought of John Fiske, was bounded W. by Thomas Bartlett; S. by Mary Feasie [Veazey]; N. by Thomas Hastings; E. by William Godfrey.

[June 23, 1703 (?), Charles Stearns, of Wat., for £40, sold 12 A. of dividend land to John Hastings. This could not have been Charles, Sen., and it has not been ascertained who he was. Perhaps it was a misnomer.]

[5.] Isaac Stearns, of Salem, was a glazier. His estate was settled in 1701.

[5-1.] Rebecca Stearns, m., Sept. 17, 1706, Ebenezer Glover.

[6.] Rebecca Stearns, b. 1661. She d. Sept. 23, 1746, aged 85.

- p. 553. [11.] See abstract of the Will of Shubael Stearns [at 540], p. 578.

[14.] It appears, by her father's Will, that Hannah, his eldest dr., m. — Stimpson.

[14½.] For 1720, read 1726.

[16.] Strike out, supposed to be his son.

[†16.] For 1736, read 1730.

[25.] [See [43] pp. 457, and 939.

- p. 554. [36.] Isaac m. Abigail Bryant, Nov. 27, 1744.

[40.] Shubael Stearns and Rebeckah Lariby, m., Dec. 29, 1704, at Kittery. [County Record.] The marriage in the text is that recorded in Tolland records by Shubael himself, when he was town clerk. It is stated, on page 554, that Shubael Stearns [40], with his large family, left Connecticut, about 1750, on account of ecclesiastical difficulties, and that he settled in North Carolina. He and his family were Baptists, and some of them, especially his son Shubael, and son-in-law Daniel Marshall, have exercised a great influence upon the religious sentiments of the South. This son was at the time of their migration about 44 years old, and he has been called a Boanerges. He first halted at Opeckoa, in Berkely Co., Virginia, where he founded a church. He there met Rev. Daniel Marshall, who had married his youngest sister, Martha, and who went from Tolland on a mission among the Indians. From Opeckoa, they moved into Hampshire Co., 30 miles from Winchester, Va. Some of his friends, who had gone to N. Carolina, invited him to come to them; and he accepted, and settled at Sandy Creek, Guilford Co., N. Carolina, where he established what was called his New Light Church, which proved to be the prolific mother of many churches at the South. He d. there, Nov. 20, 1771. When the family moved to Virginia, the broad Virginia pronunciation was given to the name, and it has been very generally written and pronounced Starnes.

We have obtained a very imperfect genealogy of the family and descendants of Shubael Stearns, who have become widely dispersed and very numerous. Of the family of Shubael, Jr. [41], the very successful preacher, nothing has been learned. His brother Peter [43], had 5 children. [See p. 554.] Charles, the eldest, settled in Charleston, S. C., where he died, and was buried in the Cemetery of the Circular Church. His daughter Mary, m. Capt. Thomas Commander Russell, an officer in the Continental line in the Revolution. Hepzibah, a daughter of Isaac [44], m. — Welborn, and they are the ancestors of the large family of that name, in N. Carolina, Georgia, and Tennessee. Ebenezer [48], after he went to the South, m. (2d) Elizabeth Young, of Buncombe Co., N. Carolina. About the time of the Revolution, he moved into S. Carolina, and afterwards into Columbia Co., Ga., where he died. His children were, 1. Dr. Samuel Scott Starnes. 2. Daniel, who m. his cousin, Harriet E. Russell, a daughter of Capt. T. C. and Mary (Starnes) Russell, and he is the father of Judge Ebenezer Starnes, of Augusta, Ga. 3. John Starnes, m. — Ware, now living in Tennessee, an aged man. 4. Mary, m. Rhodam Fallos, Esq. 5. Ebenezer, m. — Harvey, and had son William, a physician, and other children.

Rev. Daniel Marshall, who married Martha [50], the youngest dr. of Shubael Stearns, was a son of Abraham Marshall, of Connecticut, and was very distinguished and influential as a preacher. His son Abraham, was also a very distinguished Baptist preacher of Georgia. [See Benedict's History of the Baptists, published in 1848, pp. 646, 683, 84, 85, 86, and 87.]

- p. 555. [64.] Aug. 16, 1757, Jonathan Stearns, from Mendon, belonged to Capt. Abraham Williamson's company. It is not ascertained who this Jonathan was. It is evident that it could not have been Jonathan [64], unless there is a mistake in the date of his decease; and it could not be his son. Was it [544], p. 578?

- p. 557. [116.] Mar. 12, 1765, caution against (settlement of) Samuel († Daniel) Fuller, wife Lydia, and 5 chil., viz., Isaac, Lydia, Miriam, Jemima, and —, from Newton, June 25.
- p. 558. [120-e.] Chil. of Isaac and Lucy (Goss) Stearns. 1. Thomas, b. 1825; a mariner. 2. William, b. 1829; a mariner. 3. Lucy M., b. 1831. 4. Albert J. 5. Julia, b. 1833. [128.] Capt. Charles Stearns, was b. in Waltham. For Dorchester, read Roxbury. His son Charles Henry, d. Sept. 21, 1835. His 2d son Charles Henry, was b. Ap. 10, 1838. [131.] Marshall Stearns, b. in Waltham, Dec. 29, 1802; of Brookline; m., Sept. 16, 1830, Susanna Craft, dr. of Joseph and Hannah (Jones), of Brookline. His 4th child, Susan Elizabeth, b. Ap. 8, 1847, d. Ap. 22, 1850.
- p. 559. [147.] AMMI and POLLY (Stearns) STEARNS, settled in Lincoln. Chil.,
 1. Cyrus, b. Feb. 19, 1804. 2. Elijah, b. Jan. 26, 1806.
 3. Mary, b. July 6, d. Dec. 27, 1807. 4. Eliza, b. Sept. 28, d. Dec., 1808.
 5. Daniel, b. May 28, 1810. 6. Almira, b. Ap. 17, 1812; d. Mar., 1814.
 7. George, b. Feb. 2, 1816; d. Ap., 1818. 8. Prudence, b. July 7, d. Dec. 27, 1820.
- [148.] Elisha, d. in Lincoln, Ap. 20, 1845.
- [149.] In court, C. C. P. Middlesex, 1724, was a suit John Stearns, of Lex., blacksmith, vs. Parker. This implies that he did not move to Worcester until after this date. [Tradition says that Capt. John Stearns, of Worcester, had dr. Polly, who m. Joseph Dwelly, of Holden, and had one child, Joseph; and that Patience, dr. of Capt. John, m., in Worcester, Jan. 6, 1774, Isaac Clark, of Hardwick; dr. Hannah, who m. — Kinsey, of Hardwick. Perhaps this was John, Jr. [150.]
- [151-3-1.] Stephen Stearns, d. in Worcester, Ap. 20, 1845.
- p. 560. [156.] "Increase, son of John Stearns," marched to Fort Wm. Henry, Aug. 15, to Sept. 12, 1757. Increase and John, Jr., belonged to Capt. James Goodwin's Co., in 1757. [160.] Thomas Stearns, of Lex., was in Capt. Thomas Buckminster's Co., from July 25, to Aug. 26, 1721. June 27, 1719, Thomas Stearns, of Lex., for £80, mortgaged to Joseph Bowman and Joseph Brown, of Lex., 100 A. in Lex; part of the minister's farm; not discharged. In 1756, petition of Thomas Stearns, of Worcester, was presented, who had purchased land in New Braintree.
- [165.] Lydia Stearns and Alexander Campbell, pub. in Oxford, Aug. 14, 1757.
 [169.] Thomas Stearns, m., in Dudley, Mar. 5, 1769, Sarah Gleason.
 [171.] Eunice Stearns, m., Dec. 10, 1779, Thomas Fellansbee.
 [172.] Timothy Stearns and Elizabeth Jenkins, both of Wilmington, m., in Woburn, Nov. 3, 1737 [Wob. records].
- p. 561. [173.] Timothy Stearns, m. (2d), Jan. 13, 1785, wid. Sarah Williams, of Reading.
 [174.] Lydia Stearns and Col. Nathan Parker, of Reading, m., Dec. 26, 1798.
 [175.] Elizabeth Stearns m. Samuel Peters, Ap. 21, 1791.
 [176.] Amos Stearns and Sarah Watts, pub. in Chelsea, Ap. 28, 1796. Amos Stearns, and Nancy Blodgett, pub. in Chelsea, May 29, 1812.
 [178.] Thomas C. Stearns, d. Ap. 20, 1850.
 [186.] Ruth Stearns and William Johnson, m., Sept. 18, 1796.
- p. 562. [228.] Benjamin Stearns belonged to the Co. of Capt. David Wilder, commissioned Ap. 19, 1775.
 [230.] Thomas Stearns belonged to Capt. Samuel Hunt's Co., Aug. 13, to Dec. 13, 1755.
- p. 564. [277-10.] For Samuel Rand, read Thomas Rand.
 [278.] For Heverson, read Stevenson.
 [281.] Rev. W. L. Stearns, was dismissed from Rowe, Dec. 31, 1849, and installed in Pembroke, July 1, 1850.
- p. 568. [353.] John Stearns, m. (2d), Oct. 27, 1726, Rebecca Bradle. Chil.,
 1. John, b. Aug. 7, 1719 [358]. 2. Hannah. 3. Martha.
 (By 2d wife, Rebecca.)
 4. Elizabeth, m., Nov. 2, 1755, Francis Brown, Jr., of Swanzey.
 5. Eunice. 6. Rebecca.
- p. 471. [400.] Samuel Stearns, of Grafton, of Capt. Samuel Varrin's Co., in 1757.
- p. 578. [540.] In the margin, for 15½, read 16.
 [546.] David Stearns belonged to Capt. John Catlin's Co., Oct. 16, to Dec. 11, 1757.
 [552.] (†) Ebenezer Stearns was a Corporal in Edward Harrington's Co., Sept. 15, to Dec. 15, 1755.

p. 580. **NATHANIEL STEARNS.**—[1]. See Stone [4.] p. 950.

p. 582. **STEBBINS.**—[See Buzby, p. 733.] John Stebbin and Ann Munke, m., in Rox., Ap. 17, 1644. In 1648, Roxbury granted to him six acres.

p. 582. **STEWART.**—Strike out [17-1]. [See p. 789.] The parentage of this Hepzibah Hastings, has not been ascertained. Aug. 19, 1741, caution of Wat., against (settlement of) Hepzibah Stewart and her 3 chil., from Waltham. Jonas Stewart, of Waltham, belonged to Capt. Jonathan Brown's Co., at Lake George, 1758.

STICKLAND.—(Stickline, Strickland.) Serj. John Stickland, applied to be adm. freeman, Oct., 1630; was adm. May 18, 1631. He was probably one of that small company that was sent from Salem to Charlestown, in 1629, to take possession of Massachusetts Bay, and from Charlestown went very early, perhaps with Sir Richard Saltonstall, to Watertown. He was member of a jury of inquest Sept 18, 1630, and in May, 1631, of a trial jury. Sept. 4, 1632, he was fined £3, for refusing watch at the Captain's (Patrick) command. This fine was discharged by the Court, Sept. 1638. He sold his homestall in Wat., to John Whitney (who made it his permanent residence), and went with first settlers to plant Watertown (Wethersfield), Conn. He was dismissed from Wat. Church, May 29, 1635, "to forme a newe in Ch. Covenante, in this River of Conectecot." He was probably the ancestor of all the families of the name of Strickland, in New England and Long Island.

p. 583. **STIMSON.**—[1.] Jonathan Stimson was wit. in court Sept. 8, 1674, then aged 30, showing that he was born 1644. From the 3d line, strike out, he m. (2d) Abigail, by whom he had one child. He had no 2d wife. Adm. on his estate was granted wid. Elizabeth, Mar. 13, 1692-3. July 16, 1667, Abigail Benjamin, John Woodward and Abigail, his wife, for sundry considerations, sold to Jonathan Stimson, of Wat., 99 A., b. W. by Daniel Mettup; E. by Daniel Andrews; N. by Christopher Grant; S. by John Kemball. Also about 6 A. of land, bounded S. by Nonesuch Pond; N. by Henry Rice; E. by upland; W. by Wat. line. Wit. at signing, Matthew Bridge, Elizabeth Danforth. Administratrix's account of the estate of Jonathan Stimson, mentions the following children: James (eldest son), Benjamin, Jonathan, Joseph, Samuel, John, Abel; Abigail, Rebecca, Elizabeth, wife of William Harvey, Mary, d., whose funeral expenses the adm'n'x charged.

[5.] Mary, d. unm. [6.] Elizabeth, in the settlement of the estate, was wife of William Harvey. It is probable that it was Elizabeth, wid. of Jonathan Simson [1], who m., Mar. 12, 1700-1, Richard Barns, of Marlboro.

[11.] Strike out, (by 2d wife). In the record of the decease of this John, he is said to be a son of Jonathan and (?) Abigail.

p. 584. **STONE.**—[1.] For, at Ipswich, read, at London. For, [see *Geneal. Reg.*, II., 128], read, [see *Mid. Prob. Rec.*, II., 128.] The Warners were not mentioned in his Will, but in that of his wife, Sarah. The tradition in the family is that Joan, the wife of Deacon Simon Stone, who embarked with him for America, was a daughter of William Clark. His last wife, Sarah [wid. of Richard Lumpkin], in her Will, made a bequest of £60 to her kinsman, John Warner, and John and Daniel Warner, were residuary legatees. It is not improbable, from anything yet discovered, that in her Will, for Warner, we should read Warren. John Warren, of Wat., had only two sons, John and Daniel, and each of them had a daughter Sarah, although neither their mother, nor either of their wives, bore that name. The homestall of Dea. Simon Stone, of 40 acres, was on the south of Mount Auburn Cemetery, and probably it embraced a part of the land, which was included in it, formerly called Stone's Woods [See Will of Dea. Simon Stone, *Geneal. Reg.*, III., p. 182.]

p. 585. [2.] Frances Stone, m. (1st) Rev. Henry Green. [See Green, p. 776.] He d. early, leaving two children, and his wid. m. again, and had children. The name of her 2d husband not ascertained.

[2½.] There is a tradition in the family, that Ann Stone m. — Orne, and died early.

[4.] Tradition says that Mary, 3d dr. of Dea. Simon Stone, m. — Stearns. If this be correct, she was probably the wife of Lieut. Nathaniel Stearns, of Dedham. [See p. 580.]

[6.] Mary Whipple, was a daughter of John and Sarah Whipple, of Ipswich. Mr. Whipple, was fessée of the Grammar-school; a deputy to the Gen. Court, 1640, 41, 42, 46, 50, 51, 52, 53; a deacon and ruling elder in the first church. He d. June 30, 1669.

[6½.] Simon, Jr., and Mary (Whipple) Stone, had a son Simon (their eldest child), whose birth is not recorded. He settled in Groton [see p. 589].

- [7.] John, the 2d son, also settled in Groton.
- [18.] This is both "Stearns," and "Star, of Dedham," in the Wat. Church Record. There is little doubt, but that this Mary Stone m. Dea. Comfort Starr, of Dedham. [Mar. 21, 1634-5, Comfort Starr, chirurgeon, of Ashford, Co. Kent, with three children and three servants, obtained of the Vicar and Justices of Ashford, a certificate for embarkation. Comfort Starr, grad. Harv. Coll., 1647, was probably the youngest of those children; and the Simon Starr, mentioned in Mass. Hist. Coll., 3d Ser. viii., p. 310, may have derived his name from Simon Stone.] [See Eire, p. 756; also Caulkin's Hist. N. London, p. 319; Winsor's Hist. Duxbury, p. 323; Deane's Hist. Scituate, p. 347.]
- [19.] Rev. Nathaniel Stone, m. Reliance Hinckley, youngest dr. of Gov. Thomas Hinckley, by his 2d wife, Mary, dr. of Quartermaster Smith, who came over in 1635, and settled in Dorchester. She (Mary Smith) had m. (1st) Mr. Nathaniel Glover, of Dorchester (son of John Glover, Esq.), by whom she had 1. Nathaniel. 2. Anna. [See General Reg., I., 95.]
- [22.] It was this Elizabeth Stone, who m. Dea. Isaac Stearns, who moved from Lex. to Stoughton. [See [16], p. 456.]
- p. 586. [23.] David Stone had a 3d dr., Ruth, birth not recorded, who m. Dea. Nathaniel Stone. [124.]
- [25.] Mary Stone, dr. of David, m., Jan. 10, 1737-8, Henry Fiske. [N. Fiske, [31.] and [31], p. 760.]
- [28.] Dea. John Stone was selectman 1674, 81, 82, 83, 84, 85, 86, 87, 90, and was town clerk, 1687, and 90. He was released from training, Jan. 9, 1687, then aged 52. He m. Sarah Bass, youngest dr. of Samuel and Anne Bass, of Braintree, where his dr. Sarah, was born, Oct. 1, 1663. He died early in 1691, and his wid. Sarah, m., May 10, 1693, Dea. Joseph Penniman. She lived to be nearly 100 years old. [See Thayer's Family Memorial, p. 66; and Mitchell, p. 110.] Inventory of Dea. John Stone, dated Ap. 28, 1691, by Thomas Fleg, Sen., Samuel Eddy, and William Bond, Sen. House, and 200 A. of upland, £110, and five other smaller lots. Agreement of his heirs, Ap. 6, 1692, viz.: wid. Sarah, eldest son John, eldest dr. Sarah, wife of Munning Sawin, and drs. Joanna, Ann, Hepzibah, Deborah, Rebecca, and Elizabeth.
- [31.] The wife of this John Stone, was named Thankful.
- [31-4.] Strike out all after 1705, and see [25.] above. [35.] Samuel prob. d. young.
- [32.] Anne, (?) m., Nov., 1693, Samuel Capen.
- [38.] Rebecca Stone, m., Nov. 6, 1706, John Maddock, of Boston. In the copy of the town record it is Elizabeth Stone. [See [22], p. 586; and [22] above.]
- [39.] Hon. Ebenezer Stone, d. Oct. 4, 1754, set. 92. The date of his 3d marriage should probably be 1724. [See Barry, p. 410; and Jackson's Hist. of Newton, p. 411.]
- [40.] Ens. Ebenezer Stone was Constable 1730, and selectman 1741, 46, and 56. The eldest child of Ebenezer and Sarah (Bond) Stone, was Nathaniel, b. May 7, 1714. [See 124.] pp. 588 and 954.]
- [41.] For Oct. 4, read, Oct. 29.
- [44.] Nathan Stone went to Norwich, Conn., and d. Sept. 20, 1765, unm.
- [46.] For 1723, read 1725. Sarah Stone, m., Aug. 13, 1747, Joseph Greenwood, of Holden.
- [49.] "Mrs. Kezia Stone" taught school in Wat., 12 weeks, from Jan. 1, 1767. She d. Ap. 5, 1788, aged 57, unm.
- [50.] Margaret Stone. [See Hammond, 72, p. 781.]
- p. 587. [57.] Dea. John Stone, selectman 9 yrs., d. 1769, and his wid. d. 1788, aged 90.
- [58.] Margaret Stone, m., in 1739, Noah Shepherd.
- [60.] Jonas Stone, a selectman 6 yrs., d. in 1804, aged 82; and his wife d. 1794, aged 72.
- [65.] Anna Stone, m. (?) Thomas Stowell [124], of Worcester.
- [71.] Dea. David Stone, of Newton, took the paternal homestead, d. 1802. He m., 1754, Mary Herring. Chil., 1. Aaron, b. Oct. 21, 1757. 2. Moses, b. Dec. 4, 1759. 3. Mary, b. Sept. 27, 1762. 4. Betsey, b. Feb. 13, 1765. 5. Isaac, b. Oct. 9, 1767.
- [74.] Dea. John Stone, of Newton, m., June, 1762, Martha, dr. of Moses Craft. He d. 1797, set. 60, and his wid. d. in 1816, aged 73. Chil., 1. Oliver, b. Mar. 24, 1763. 2. Asa, b. May 15, 1765. 3. Esther, b. Dec. 15, 1767. 4. Lydia, b. Ap. 20, 1771; m., 1793, John Thompson, of Wat. 5. Hannah, b. Ap. 6, 1773; m., 1795, Solomon Alden. 6. Martha, b. Mar. 20, 1775. 7. John, b. May 2, 1777. 8. Asa, b. Aug. 1, 1779. 9. Anna, b. Oct. 28, 1781. 10. Aaron, b. Jan. 1, 1784.
- [78.] Chil. of SIMON and PRISCILLA STONE.

1. *Mary*, b. June 8, 1733. 2. *Experience*, 3. *Mary* (twins), b. July 10, 1735.
4. *Mary*, b. June 8, 1737. 5. *Ephraim*, b. May 12, 1741. 6. *Bethia*, b. Oct. 9, 1743.
7. *James*, b. Dec. 15, 1744; of Newton; m., Dec. 31, 1767, *Sarah Billings*. He d. Nov. 24, 1836, aged 92. 12 chil.

[79.] For June 1, read June 8.

p. 588. [93.] For, 92, 93, in the margin, read, 94, 93.

[94.] Moses Stone, had only one wife, Hannah Tainter. He was selectman, 1763 to 1770, inclusive.

[95.] For 1763, read 1767. This Mary Stone, m. (1st) Aaron Tufts, of Charlestown. She m. (2d), June 6, 1776, William Lyon, of Woodstock.

[96.] Capt. Moses Stone, Jr., occupied his father's homestead, and owned the largest part of the land belonging to Mount Auburn Cemetery. It was formerly called Stone's Woods. His first wife, Elizabeth, d. Jan. 11, 1785, and his 2d wife, Abigail, d. Mar. 19, 1844, aged 80. After the d. of his widow, the property was sold to M. P. Brazee. The old family mansion was destroyed by fire, and then the property passed into the hands of Col. Winchester, who has built thereon a very magnificent mansion, probably not surpassed by any one in that region.

[97.] MOSES STONE, Jr., m., Ap. 8, 1802, BETSEY BROWN, of Watertown, a granddr. of Joseph Coolidge, and settled in Jay, Me. Chil.,

1. *Eliza Ann*, m. — *Leach*, of Livermore Falls, Me.
2. *Rhoda*, m. — *Mace*, of Dead River, Me.
3. *Emily*, m. — *Wadsworth*, of Bath, Me.
4. *Moses*; of Jay, Me.; m. — *Parker*, many children.
5. *Aaron*; of Jay, living on the homestead.
6. *Cornelius*; grad. Bowd. Coll., 1840; a minister, of the M. E. Church, m. — Sylvester, of Jay.

[98.] Chil. of I. W. and ELIZABETH (Stone) PAGE.

1. *William A.*; d. in early manhood.
2. *Charles A.*; of Hollowell; m. *Sarah G. Orne*. 3. *George*.

[99.] Chil. of MOSES M. and RHODA (Stone) CRAFT.

1. *Amasa*; of Jay, now (1855) of Minnesota; m. twice.
2. *Harriet Ann*, m. (1st) Dr. *Thompson*, of Wilton, Me.; and m. (2d) *Daniel Gross*, of Jay.
3. *Eliza Jane*, m. *Daniel Gross*, of Jay. 4. *Columbus*, went to the West.
5. *Henry*, supposed to have been murdered, from his mysterious disappearance in boyhood.

[100.] CORNELIUS STONE, m., Dec. 6, 1810, MELINDA STONE, dr. of Nathaniel, Jr. He d. Dec. 23, 1823, æt. 41. See p. 954. Chil.,

1. *Cornelius*. 2. *Louisa*, both d. early.
3. *James Frederick*, a farmer, of Waltham, m., July, 1842, *Mary Ann Randall*. Chil., 1. Edmund Augustus. 2. Ellen Louisa. 3. Cornelius. 4. Watson P. 5. Judson F. 6. Fanny M.
4. *Wm. Augustus* (twin), a farmer, of Watertown, unm.
5. *Harriet E.*, d. early, unm. 6. *Ellen Louisa*, d. early, unm. 7. *Elmira*.

[100.] ASAPH STONE, long and well known as a merchant, successively of Boston, Philadelphia, and New York; distinguished for his enterprise and energy, for his refined taste and gentlemanly demeanor; m., in Boston, May 20, 1810, JANE M'FARLANE, of Boston. "Mrs. Stone was a remarkably energetic, high-minded woman, of ardent affections, quick sensibilities, good judgment, and active benevolence." He, his wife and youngest dr., were lost on board of the Arctic, Sept. 27, 1854. Chil.,

1. *Jane Maria*, b. in Boston, Dec. 27, 1811; m., June 16, 1830, *Edwin Lord*, of New York. Chil.,
 1. *Jane Maria*, m. Miller Griffith, now (1855) of California.
 2. *Charles*. 3. *Edwin*. 4. *Caroline*.
2. *Henry Asaph*, b. in Boston, June 22, 1814; merchant, of N. York; m., at Hurl Gate, Sept. 14, 1836, *Mary Foulke*.
3. *Helen Augusta*, b. in Philadelphia, Aug. 31, 1816; d. in infancy.
4. *Harriet Helen*, b. in P., Feb. 28, 1818; m., May 4, 1842, *Geo. B. English*, of Philada., now of N. Y.; 6 drs.
5. *Andrew Sigourney*, b. in P., Jan. 31, 1820; a farmer, of Tremont, Ill., whither he went in boyhood; m., in 1841, *Sylvia Hayward*; several children.

6. *George Elliot*, b. in P., Jan. 17, 1822; merchant, of N. York; m., Oct. 12, 1852, *Frances Kendall*, of Brookline.
 7. *Wood Gibson*, b. in P., Feb. 8, 1824; farmer; m. *Margaret McKeever*, of New Jersey. He d. in 1851, on his return from California, leaving one dr.
 8. *John Cameron*, b. in N. York, Feb. 21, 1826; oil-merchant, of N. York; m., Oct., 1853, *Emma Adelaide Bridge*.
 9. *Edwin Lord*, b. in N. Y., Ap. 10, 1828; merchant, of San Francisco; m., in Oct., 1853, *Emily Coad*.
 10. *James Mason*, b. in N. Y., May 8, 1830; merchant, of N. York.
 11. *Bradford Lincoln*, b. in N. Y., Dec. 6, 1833, d. soon.
 12. *Mary Foulke*, b. in N. Y., May 31, 1836; lost on board the Arctic, Sept. 27, 1854.
- [101.] AARON STONE, a merchant, of N. York, m. ELIZA HIXON, of Manchester, Eng. Chil.,
1. *John R.*, a lawyer, of N. York. 2. *Harriet*, m. — *Van Winkle*, of N. York.
 3. *Thomas H.*, a merchant, of Buffalo, N. Y.
 4. *Letitia Unette*, m. *Hiram P. Ward*, of Buffalo.
 5. *Aaron*, d. young. 6 and 7, d. in infancy.
- [101½.] ABIGAIL STONE, m. JOSEPH JOHNSON, merchant, first of Hallowell, Me.; afterwards of Rochester, N. Y. Mr. Johnson is d., and his wid. resides in Medina, New York. Chil.,
1. *Harriet Emeline*, m. Rev. *Charles E. Furman*, of Medina. 5 chil.
 2. *Joseph Asaph*, d. unmarried.
 3. *Abby Eliza*, m. — *Ball*, now of St. Paul's, Minnesota.
 4. *Geo. Albert*, of N. York. 5. *Thomas Henry*, a minister, of Illinois.
 6. *Edward Columbus*. 7. *Joel Stone*, d. early. 8. *Sarah Ann*, d. 9. *Charles*.
- [102.] NANCY [Ann], m. JOHN GERRY ORNE, merchant, of Marblehead. He was a grandson of Hon. Azor Orne, of Marblehead, a distinguished patriot of the Revolution, and grand nephew of Gov. E. Gerry. He d. Feb. 24, 1838, and his wid. now (1855) resides in Cambridgeport. Chil.,
1. *Francis Henry*, a shipmaster, unm., supposed to be dead.
 2. *Maria Elizabeth*, m. *John P. Whiton*, and d. May 5, 1844. 2 chil.
 3. *Sarah Gerry*, m. *Charles A. Page*, of Hallowell. 4. *Caroline Frances*; unm.
 5. *Charles Asaph*, d. unm., on his passage from California.
 6. *Joel Stone*, of Cambridgeport, m. *Rachel A. Brown*. Chil.,
 1. *Maria Frances*. 2. *Charles Parker*.
- [102½.] JOEL STONE, m. (1st) ELIZA SIGOURNEY, dr. of Andrew S., of Boston. He m. (2d) MARY WILBUR, who d. Feb. 7, 1844. Chil.,
1. *Joel*, a merchant, of Liverpool, Eng., married.
 2. *Charles Francis*, now (1855) of the Sen. Class in Harv. Coll.
 3. *Robert*, studying surgery (in 1855), in New Haven.
 - 4 and 5, died in infancy. 6. *Mary*.
- [103.] Columbus C. Stone, merchant, of Waltham, m. Hebe Hinman.
- [103½.] Harriet Stone, m. Caleb Swan, merchant, of N. York.
- [104.] WILLIAM and HANNAH (Barnard) STONE moved to Woodstock, Conn., very soon after marriage. They returned to Watertown in the spring of 1783. He d. May 8, 1808, and his wid. d. Nov. 3, 1834, aged 80. Chil.,
1. *Hannah*, b. in Woodstock, Jan. 28, 1778; m., July 31, 1796, *Daniel Bond* [144].
 2. *Mary*, b. in Woodstock, Dec. 17, 1779; m. *Seth Bird*, of Portland. [Seth Bird and Elizabeth Sawin m. in Wat., July 17, 1796.]
 3. *William*, b. in Woodstock, Sept. 28, 1781; m., Ap. 9, 1807, *Elizabeth Coolidge* [277]. Chil.,
 1. *Elizabeth*, b. June 28, 1808; m., Sept. 11, 1828, *Seriah Stevens*.
 2. *William*, b. Mar. 5, 1810. 3. *Sarah A.*, b. Ap. 17, 1812.
 4. *George C.*, b. June 13, 1814, of New York; m. *Sarah Wheeler*.
 5. *Emily*, b. July 11, 1818. 6. *Julia*, b. Dec. 18, 1821.
 4. *Abigail*, b. in Wat., Oct. 12, 1783; m., Ap. 11, 1805, *Thomas Richardson*.
 5. *Leonard*, b. in Wat., Feb. 16, 1785. [See 71, p. 536.]
 6. *Richard*, b. Oct. 21, 1787; settled in Baltimore about 1810; had a family, and d. Ap. 25, 183—.
 7. *Hepzibah*, b. Mar. 21, 1789; m., Ap. 12, 1810, *Jesse Bird*.
 8. *Joseph*, b. Nov. 1, 1790. m. 9. *Betsy*, bap. Sept., 1792; m.
 10. *Susanna*, b. Oct. 4, 1793; m. 11. *Eliza*, b. June 11, 1795; m. *Asa Pratt*.

12. *Seth*, b. Jan. 22, 1797; settled in Baltimore. 13. *Eveline*, b. June 12, 1799, unm.
14. *Caroline* (twin), b. June 12, 1799; m. *George Robbins*.
15. *Anna*, b. Feb. 20, 1802; m. *Constantine Swan*, of W. Camb.
- [117.] **JONATHAN STONE**, of Wat., m. in May, 1783, *SARAH WATSON*, of Cambridge. He d. Ap. 25, 1825, aged 72, and his wid. d. Feb. 27, 1849, aged 87. Chil. [See their births, p. 588.]
1. *Sally*, b. Oct. 15, 1784; m., Dec. 1, 1806, *Nathaniel P. Whitney, Jr.* [182.]
 2. *Jonathan*, b. Mar. 12, 1787; m. *Anna Coolidge*; d. in Baltimore, leaving 3 chil., 1. Ann. 2. Julia. 3. Helen.
 3. *Charles*, b. Ap. 8, 1789; m. (1st), Nov. 23, 1815, *Julianna Webber*, of Wat. She d. in 1825, and he m. (2d), Aug. 13, 1826, *Sarah Spear*, of Quincy. Chil., 1. Charles H. 2. George E. 3. Sarah W. 4. Mary Spear. 5. Henry F. 6. Frances M. 7. John Howard.
 4. *Samuel*, b. June 28, 1791; m. (1st), — *Hovey*, of Dracont, and afterwards a 2d wife. Chil., 1. Charles W. 2. Henry H.
 5. *Rebecca*, b. Jan. 8, bap. Oct. 1, 1795, d. Sept. 22, 1801.
 6. *Joseph Watson*, b. Ap., 1797; m. wid. of his brother Jonathan; d. in N. Orleans, about 1837. Chil., 1. Joseph W. 2. Henry Clay. 3. Ellen.
 7. *Anna*, b. Mar. 21; bap. June 8, 1800, d. Sept. 30, 1801.
 8. *Edward*, b. Feb. 14, bap. Feb. 20, 1803; of Lowell.
 9. *Moses*, b. Jan. 27, bap. Feb. 8, 1805; m., Aug. 21, 1839, *Abigail Marsh*, of Quincy, b. Oct. 20, 1815. Chil., 1. George Watson. 2. Sophia Marsh, d.
- [124.] **Dea. NATHANIEL STONE**, b. May 7, 1714, eldest child of Ebenezer, Jr., and Sarah (Bond) Stone; m. *RUTH STONE*, dr. of David Stone [23], and [40], p. 951.] There is extant a register of the deaths occurring in Watertown during 15 years (1738-53), carefully kept by him. Chil.,
1. *David*, b. Nov. 11, 1747, d. Dec. 22, 1824, aged 77; m. *Abigail Child*, and had one son, viz., 1. Stephen, of Waltham, by wife Ann, 4 chil.
 2. *Josiah*, b. Sept. 3, d. Oct. 5, 1749.
 3. *Daniel*, b. Dec. 21, 1750, d. Aug. 16, 1766, aged 16 years.
 4. *Abijah*, b. Oct. 15, 1752; m., Dec. 5, 1782, *Abigail Mason*, dr. of Samuel and Esther (Myrick) Mason, of Newton. He d. Mar. 2, 1837, aged 84, and his wid. d. Jan. 28, 1839, aged 85. Chil.,
 1. Lucy, b. Ap. 28, 1783, d. Sept. 2, 1815, unm.
 2. Josiah, b. Nov. 22, 1785; m. Mary Thing, of Newton.
 1. Maria, m. Farwell Hoar, of Watertown, from Vermont.
 3. Abigail, b. Nov. 10, 1787, d. Jan. 5, 1820.
 4. Abijah, b. Mar. 19, 1790; an itinerant preacher; m. Nancy Woods, of Chester, Vt.
 5. Catherine, b. May 2, 1793; d. 6. Maria, b. July 1, 1795; m. — Hoar.
 7. Hepsy; and 8. Hannah (twins), b. Sept. 3, 1797, d. soon.
 9. Esther M., b. Mar. 24, 1800. Several d. in infancy.
 5. a dr., b. and d. Mar. 17, 1754.
 6. *Elizabeth*, b. May 3, 1756; m. Capt. *Moses Stone* [96]. 4 chil. She d. Mar. 10, 1785.
 7. *James*, b. June 13, 1758, d. Aug. 27, 1787, aged 29, unm.
 8. *Nathaniel*, b. July 21, 1760; m. *Jerusha Learned* [49]. Chil.,
 1. Nathan, b. Dec. 29, 1783, of Frankfort, Me.; m. June 1800, Beulah Sullivan, of Frankfort. 1. Jason, of Ohio. 2. Daniel, m. Abigail Emery, of Hampden. 3. Nathaniel, d. at sea, unm. 4. Jerusha, drowned. 5. Otis, a shipmaster, of N. York. 6. several d. young.
 2. James, d. aged 2 years.
 3. Melinda, b. Feb. 28, 1788; m., Dec. 6, 1810, Cornelius Stone [see [100], p. 952.]
 4. James, b. May 12, 1790, of Wat.; m. Nancy Pidgeon. 9 chil., 1. Albert; m. 2. Leander; d. 3. Venera. 4. Leander, m. Adeline Everett. 5. Mary Ann, m. Anson J. Stone, of Camb. 6. Caroline, m. Nathaniel Pease, of Brighton, and moved to Illinois. 7. Jerusha. 8. Jane, d. 9. Jane.
 5. David, b. Dec. 1793; m. Sally Coolidge, of Wat. 8 chil., 1. David, of N. York, unm. 2. Eliza Ann, d. Feb. 22, 1854, aged 21. 3. Joshua. 4. Theodore; d. 5. Sarah Jane. 6. Joseph. 7. Adeline. 8. Emma, d. an infant.
 6. Lucinda, b. July, 1795; m. Samuel Olney, of Providence, R. I. 4 chil., 1. Ellen Jerusha. 2. Julia Ann. 3. Louisa. 4. Albert.

7. Isaac, b. Mar., 1797; m. Elmira Atwood, of Frankfort, Me.; resides in East Cambridge. 6 chil., 1. Harriet Eliza. 2. Jerusha Ann; d. 3. Francis Atwood. 4. Willis Freeman. 5. Anna Atwood. 6. Grace Alice.
 8. Jerusha. 9. David P., d. young.
 10. Elmira, b. Feb. 26, 1803; m., Nov. 1844, Peter Underwood, of Lincoln, and they live in E. Camb.
 11. Nathaniel, b. Oct., 1805; m. Susan Dunklee, of Lex. 4 chil., 1. Martha E. 2. Charles E. 3. George F. 4. Ella F.
 12. Edwin, b. Nov., 1807, of N. York; m. (1st), Elizabeth Durmeford, of N. Hamp. He m. (2d), Elizabeth —. 5 chil., 1. Edwin H. (By 2d wife), 2. John Walker, d. 3. Benjamin F., d. 4. Mary E. 5. Isaac F.
 9. Rhoda, b. May 14, 1765, d. Feb. 9, 1766.

p. 591. **STORER.**—Rev. Seth Storer, of Wat., and Mrs. Mary Coney, m. in Boston, May 9, 1734, by Rev. T. Foxcroft. [See Geneal. Reg. vi., p. 273.]

STOWELL.—[1.] Samuel Stowell was a clothier. May 23, 1738, he, wife, and 5 chil., viz., Josiah, Thomas, Cornelius, Mary, and Elizabeth, and Indian girl, Margaret, moved from Waltham to Wat., and resided (?) on the S. side of Charles River. [5.] Josiah Stowell, previous to Sept. 7, 1754, had become a member of Christ Church, in Boston. He moved from Boston, mid. of March, 1764. The next year he moved to Newton.

p. 592. [21.] Mar. 5, 1718–19, John Stowell, of Newton, for £100, bought of Obadiah Coolidge, of Newton, and John Sawin, and Daniel Bond, of Wat., a house, shop and $\frac{1}{2}$ acre of land, bounded E. by Boston Road; N. and W. by Stephen Cook; S. by wid. Ruth Child. [See Maddock [2.], p. 855.] John Stowell was Constable of Wat., in 1737.
 [29 and 30.] These (David and Daniel), were probably identical.

STOWERS.—In 1644, John Stowers sold his first homestead in Wat., to Bartholomew Pierson. [See Pierson, p. 910.]

STRAIGHT.—[1.] For adm. freeman, read, took oath of fidelity. Capt. Thomas Straight was wit. in 1666, then aged 47, showing that he was b. about 1619.

[3.] Thomas Straight, Jr., m. Mary, dr. of John Shepard, of Concord. She was b. 1662, and was taken captive, 1676. [John Sheppard, d. Dec. 15, 1699, leaving 2 sons and 6 daughters.] He was a selectman 1704. 8, 12, 16, 30, and Treasurer, 1708.

p. 593. **STRATTON.**—[2.] Jan. 1, 1654–5, Thomas Adams and wife Mary, of Concord, sold to Samuel Stratton, of said town, the house lately called "the house of John Adams."

[10.] John Stratton was selectman 1682 and 83.

[18.] Jan. 5, 1701–2, Mary, wid. of John Stratton, d., and her eldest son (John), appointed Edward Winn, of Wob. (who m. Mary, her eldest dr.), att'y to dispose of land in Boston and elsewhere.

[19.] Inventory of John Stratton and Bethsheba, his wife, dated Sept. 23, 1709, £46 6s. 6d. Her father, John Applin, administrator.

p. 594. [39 and 40.] Jan. 23, 1701, Edward Winn, of Wob., appointed guardian of Jonathan and Mercy Stratton.

[48.] John Stratton resided some time in Camb., and returned to Wat., with wife and 4 chil., in Mar., 1762.

[54.] June 29, 1740, Lydia, Jemima, and Kezia, drs. of Joseph and Sarah Stratton, o. c., in Waltham.

p. 594. [?] May 1, 1806, the widow's third, of the estate of John Stratton, of Weston, was set off to his relict, Abigail, then wife of Seth Babcock; also to Win. S. Moore, and to Abigail Stratton. Mary, wife of Bezabel Flagg, had a claim on the estate.

p. 596. **STREETER.**—Stephen Streeter, with wife Ursula, adm. f. c. Charlestown, Mar. 21, 1652. Caution by Wat., Jan. 3, 1692–3, against (settlement of) Stephen Streeter, and wife.

STURGEON.—Rev. Robert Sturgeon, was one of those who officiated some time in the church gathered by Rev. Mr. Angier. He had some strenuous opposers in the town, but was sustained by the church, or a large part of it, embracing many of the most respectable persons in the town. Jan. 11, 1721–2, sixty-three of the substantial

citizens, signed an obligation to pay him a salary of £84 per annum. Aug. 28, 1722, caution by selectmen of Wat., against (settlement of) "Robert Sturgeon, who came from Woburn, Dec., 1721, being a stranger arrived from Ireland." Jan. 9, 1722-3, information was lodged against him, and he was obliged to give bonds (£100—Joshua Bigelow and Joseph Harrington, sureties,) for his appearance at court. At the Court, Mar. 12, 1722-3, the grand jury found an indictment against him, charging him with "preaching and administering the Holy Ordinances, and acting as a pastor to the pretended church in Watertown," and "continuing his wicked and malicious inclinations to overthrow, ruin, and subvert, as well the churches of said Watertown, as the other churches of this province, here happily and religiously established," &c. &c. He was found guilty, and fined £20 and costs; appealed, and gave as security Ebenezer and Thomas Wellington.*

SWAIN.—(Swaine, Swayne.) In the list of the possessions of Dea. Simon Stone, in 1642, are included 8 acres (part of his homestead), and 2½ acres of meadow, bought of "John Swaine." Is not this a misnomer for William Swain? William Swaine, then aged 50, embarked with Clement Chaplin, in the Elizabeth and Ann, in Ap., 1635, was adm. freeman, Mar. 3, 1635-6; Rep. of Wat., in May, 1636; and, about that time, with other Watertown people, he moved to Wethersfield, Conn., and was a member of the third court in the colony, held Sept. 1, 1636, and of the several succeeding ones. He, and Andrew Ward, of Watertown, were two of the commissioners appointed by the Gen. Court, Mar. 3, 1635-6, "to govern the people at Connecticut." He left Wethersfield about 1644, with others, to commence the plantation of Branford. These very early appointments to office imply a very good repute. He could have resided in Watertown only one year. See Colonial Records, I., p. 171.

SWIFT.—In 1636, William Swift mortgaged his house and lands in Wat., to John Haines, Att'y of Andrew Coleman, in England, to whom Swift had given his name as joint security in a matter where Roger Spring was the principal debtor. [See Colon. Records, Sept. 1, 1640.]

TABOR.—Philip Tabor, adm. freeman, May 14, 1634; was proprietor of 5 lots of land in Wat., which he sold to John Woolcot. His wife was, probably, Lydia, dr. of Mr. John Masters, of Watertown. [See Geneal. Reg., II., p. 180.] Philip Tabor, member of Watertown Church, but residing in Yarmouth, had son John, bap. in Y., Nov. 8, 1640.

TAINTER.—[1.] Joseph Tainter was selectman, 1657, 64, 65, 67, 72, 80.

- | | |
|----|---|
| 1 | p. 597. [16.] (III.) SIMON TAINTER, Jr., b. Feb. 28, 1693-4; m., May 25, 1714, REBECCA HARRINGTON. [43.] He was adm. f. c. Westboro, Ap. 3, 1726, and wife Rebecca dismissed from Wat. to Westboro, June 27, 1731. Chil., |
| 2 | 1. Simon, b. in Wat., Ap. 8, 1715; m., in Westboro, Nov. 20, 1740, <i>Mary Bruer</i> . She was dismissed to Grafton, Sept. 6, 1741. Chil., |
| 3 | 1. Jonathan, bap. June 10, 1744. 2. Nahum, b. Feb. 23, 1750-1. |
| 5 | 3. Eleanor, b. Nov. 11, 1753. |
| 6 | 2. Rebecca, b. in Wat., Jan. 1, 1716-17; adm. f. c. Westboro, Jan. 26, 1735. |
| 7 | 3. Joanna, b. in Wat., Feb. 16, 1717-18. |
| 8 | 4. Susanna, b. in Wat., Dec. 18, 1720; adm. f. c. Westb., Sept. 6, 1741. |
| 9 | 5. Jonathan, b. in Wat., Aug. 5, 1723. |
| 10 | 6. Sarah, bap. in Wat., Aug. 1, 1725; adm. f. c. Westb., Aug. 19, 1744. |
| 11 | 7. Benjamin, bap. in Westboro, June 4, 1727; of Westboro; m. <i>Hannah</i> —. He was adm. f. c., Nov. 6, 1748, and she was adm. f. c. from Somers, about 1753. Chil., |

* Soon after the decease of Mr. Angier, a controversy arose about a division of the town into two precincts, and about the location of the two meeting-houses. These subjects were referred to the General Court, who appointed a committee of 3 of the Council, and 4 of the House of Representatives; and they reported Dec. 3, 1736, the boundary between the two precincts (which was surveyed Dec. 13); and that the New or Western [Mr. Angier's] meeting-house, shall be removed within two years to the rising ground 20 rods west of Nathaniel Livermore, or a new one built; and that within 10 years, the Old or East meeting-house be removed, or a new one built on Schoolhouse Hill, Ap. 29, 1721; at a town-meeting, it was voted to remove the meeting-houses. Many of those best accommodated with the Angier meeting-house where it was, were not disposed to accept or comply with the report of the committee, and determined to maintain worship, where it had been done for about 25 years. For this purpose, they employed Mr. Sturgeon, as their pastor; and his concurrence in their purpose appears to have been the only ground of the heinous charges brought against him.

- 12 1. Benjamin, b. May 27, 1753; m., May 6, 1776, Margaret Hinds.
 13 1. Elisha Livermore, b. Feb. 5, 1777. 2. Sophia, b. May 12, 1779.
 15 2. Jonathan, b. June 26, 1755; m. (pub. Sept. 21), 1776, Jemima Root,
 of Somers. Chil.,
 16 1. Polly, b. Ap. 12, 1778. 2. Jemima, b. July 24, 1779.
 18 3. Josiah Wood, b. July 24, 1757; d. June 16, 1759.
 4. Stephen, b. Oct. 13, 1760. 5. Samuel, b. May 3, 1762.
 20 6. Hannah, b. Mar. 9, d. May 27, 1765. 7. Hannah, b. May 2, 1769.
 21 8. *Elizabeth*, b. in Westboro, June 8, 1729; m., Nov. 19, 1750, *Stephen Sadler*,
 of Upton.
 22 9. *Samuel*, b. in Westb., May 9, 1736

23 DANIEL TAINTER, of Westboro (who d. Aug. 20, 1791), by wife KATHARINE,
 had, 1. *Katharine Sparhawk*, b. May 1, 1789.
 24 2. *Thomas*, b. Nov. 4, 1790.

- p. 597. [21.] Capt. John Tainter was selectman, 1740, 41.
 [24.] For Abraham Hill, read, Aaron Hill.
 [26.] John Tainter, Jr., belonged to Capt. Jonathan Brown's Co., in 1758.
 p. 598. [32.] For David Watson, read, Daniel Watson.
 [33.] E. Tainter's wife taught school in Wat., in 1768. He d. July 20, 1824, aged 83.

TARBALL.—[1.] Besides the house and land which Thomas Tarball, planter, sold to John Flemming, and that sold to Dea. Thomas Hastings, he also sold to John Barnard, previous to 1665, 20 poles of land, and the house where William Price now (1665) dwelleth. He wrote his name, in signing deeds, Tarbole. Concerning John Tarbell, of Danvers (who probably m. a sister of Samuel Nurse, of D.), see Mass. Hist. Coll., 3d ser., vol. III., p. 171, &c.

- [2.] Thomas Tarball, m., about 1666, Hannah (Anna) Longley, dr. of William Longley, Sen., and wife Joanna, of Groton. [See Crispe, p. 751.]
 p. 600. [70.] Asa Tarball, a miller, of Groton, m., June 19, 1803, Relief Whitney. [274.] 3 children.

- p. 601. **THATCHER.**—[1.] Oct. 2, 1666, Samuel Thatcher was one of the committee on Mystic Bridge.
 [3-3.] Dec. 9, 1730, caution against (settlement of) John Thatcher, from Suffield, Hampshire Co., Nov. last.

- p. 602. **THORNTON.**—[6 and 7.] These two, Thomas and Theophilus, were probably among those thirty, who, in 1673, engaged to commence a plantation in Worcester. [See Hist. of Worcester, pp. 7 & 8.]

[9.] It is supposed that Timothy was the 2d child. From the last line of this paragraph, strike out (?).

[11½.] In the Will of Timothy Thornton [9], there is no mention of a son Timothy, which renders it very doubtful if the following [11½] was his son. TIMOTHY THORNTON, "slater and paviour," of Boston, m. (pub. Ap. 11), 1716, ELIZABETH DANFORTH, of Billerica. Chil.,

1. *Timothy*, b. Ap. 5, 1717. 2. *Danforth*, b. Feb. 25, 1718.
 3. *Samuel*, b. Mar. 25, 1721. 4. *Elizabeth*, b. Oct. 1, 1722.
 5. *Samuel*, b. Dec. 6, 1724. 6. *Hannah*, b. Nov. 7, 1726; m. *Thomas Cartwright*.
 7. *Thomas*, b. June 13, 1729. 8. *Samuel*, b. Oct. 25, 1731.
 9. *Mary*, b. Sept. 2, 1736; m. *James Fosdick, Jr.*

- p. 603. First line, for Ballet, read Ballard. [Ballet, in the records.]
 [Note to 14.] In the first sentence, strike out all after 1724, and insert, Mary Balston.
 [20.] 3d line, for, and childhood, read, or childhood.
 p. 604. [25.] For Stephen Bowles, read, Stephen J. Bowles.

THORPE.—In a deed of Bullard to Holden, it is William, instead of Henry Thorpe, probably a misnomer.

TOMPSON.—July 3, 1704, the Sheriff ordered to be sent to fetch Christopher Tompson, in jail on suspicion of burning the fence of Capt. Benjamin Garfield (20 or 30

rods of hedge fence), denied by Tompson. Sept. 12, 1704, he was sentenced to pay Capt. G. 30 shillings, to be whipped 10 stripes, and pay costs and fees. Dec. 12, ordered that he be indented 4 years for the charges. June 16, 1705, ordered that he be sold to any of Her Majesty's subjects in the neighboring colonies. He was a 2d time ordered to be sold. George Thompson, of Wat., belonged to Capt. Jonathan Brown's Co., at Lake George, in 1758.

TOWNSEND.—[1.] Strike this out; it was an oversight, discovered too late. See Underwood [1], p. 810.

[2.] Strike out, probably son of the preceding. Ap. 7, 1691, Martin Townsend, then a witness, aged 47, showing by this, that he was born in 1644. Thomas Hammond was admn. of his estate. Feb. 6, 1699, guardianship of his sons, Martin, aged about 16, and Jonathan, aged about 12, was granted to (?) their sister, Abigail, spinster. In the settlement of the estate, there is mention of "prospects from Carolina." [2-2.] July 9, 1711, Martin Townsend, of Wat., sold to Joshua Kendall, of Wat., weaver, the house and four lots of land in Wat., "all formerly of Martin Townsend, his father, late of Carolina, deceased."

p. 605. [5.] For, — Woolcott, read Hepzibah Woolcott.

TOZER.—[2.] July 1, 1729, caution against (settlement of) John Tozer, and family, from Newton, last April. [See Jackson's Hist., p. 418.]

p. 606. **TRAINE.**—[16.] For 9. 16, in the margin, read 8. 16.

p. 607. First line. Rebecca Hammond, b. Jan. 17, 1757, was a dr. of Samuel and Mary (Fiske) Hammond, of Newton. [See 122, p. 783.] Ephraim and Rebecca (H.) Traine, had son Samuel (Esq.), who settled in Medford.

p. 608. **TREADWAY.**—[8.] It was Hannah Treadway [6], who m., May, 1711, Benjamin Lambert, Jr., of Barnstable. She d. Sept. 19, 1714. [Geneal. Reg., III., p. 272.]

[20.] Josiah Treadway, m. (2d), in Charlestown, Feb. 3, 1697-8, Dorothy Cutler. She was adm. f. c. in Charlestown, Mar. 11, 1715-16. He d. there, Jan. 15, 1732, aged 81 [gravestone]. Daughter Catherine, bap. Dec. 5, 1703.

p. 609. **TROWBRIDGE.***—[1.] Dea. James Trowbridge, b. in Dorchester, 1636, was one of the three (Thomas, William, and James), sons of Thomas, who came from Taunton, Co. Somerset, to Dorchester, where he remained a few years, then returned to England, in 1644, leaving his three sons in charge of Thomas Jeffries, who moved from Dorchester to New Haven, where the sons were brought up. James returned to Dorchester when he attained his majority, and soon after m. the daughter of Maj. Gen. Atherton. She d. June 17, 1672. He m. (2d), Jan. 2, 1674, Margaret Jackson, b. June 20, 1649, dr. of Dea. John Jackson, of Newton.

[4.] JOHN, of Newton, m., Feb. 27, 1708, SARAH WILSON, dr. of Joseph and Deliverance, of Newton. He d. 1737, aged 73. One child, *Jonathan*, b. July 23, 1711; m., 1734, *Jemima Bright* [82], had dr. Mary, bap. in Newton, July 10, 1743, by Rev. S. Storer.

[6.] For John Ward, read Richard Ward.

[7½.] Experience, b. Nov. 1, 1675; m. Samuel Wilson.

[8.] THOMAS, by first wife, had one son, *John*. He m. (2d), Mar. 3, 1709, *MARY GOFFE*, of Camb. He m. (3d), Jan. 7, 1716, *SUSANNA* —. He d. in New London, Conn., 1724, aged 57. Chil.,

1. *John* [see p. 609].

(By 2d wife, Mary Goffe.)

2. *Edmund*, b. 1709; grad. Harv. Coll. 1728; a very eminent Jurist, a member of Council, Att'y-Gen. of the Province, and Ch. Justice of Massachusetts; a loyalist in the Revolution. He m., Mar. 15, 1738, *Martha Remington*, s. p. He d. in Camb., Ap. 2, 1793, aged 84.

3. *Lydia*, b. 1710; m. *Richard Dana*, in 1737, and was mother of Chief Justice Francis Dana, of Cambridge.

4. *Mary*, b. 1712; m. 1733, *Ebenezer Chamberlain*.

* For a more copious account of the Trowbridge family, of Newton, see the History of Newton, by Francis Jackson, Esq., recently published. It is reported that one or more gentlemen are engaged in extensive and thorough researches, in order to obtain a complete genealogy of the Trowbridge family.

- [14.] JAMES, Jr., m. (1st), Jan. 6, 1709, HANNAH BACON, (?) dr. of Daniel. He m. (2d), 1712, HANNAH JACKSON [see Biscoe, 10]. He d. July 21, 1714, and his wid. m., Feb. 25, 1716, John Fuller, [53]. p. 708
1. *Margaret*, b. Oct. 29, 1709.
 2. *Daniel*, b. Ap. 6, 1711; m., Oct. 29, 1734, *Hannah Spring* [40].
(By 2d wife, Hannah.)
 3. *Hannah*, b. 1713; m. 1731, *Daniel Robbins*. She d. June 15, 1734, leaving one child, Daniel, b. Jan. 10, 1733.
 4. *Jemima*.
- [18.] Dea. WILLIAM TROWBRIDGE, of Newton; m. (1st), Dec. 14, 1708, SARAH WARD, b. Mar. 25, 1685, dr. of John and Mary (Spring) Ward. [See Ward Family, p. 44, and see Spring [14].] She d. June 21, 1720. He m. (2d), May 30, 1721, SARAH FULHAM [Fulham, 12]. She d. Sept. 10, 1787, aged 93. He d. Nov. 19, 1744, aged 60. Chil.,
1. *Mary*, b. Sept. 18, 1709; m., Aug. 6, 1729, *Richard Coolidge, Jr.* [75]. She d. Ap. 28, 1734, leaving 3 drs. and one son.
 2. *William*, b. Feb. 2, 1711. 3. *Huldah*, b. Feb. 13, 1712. 4. *William*, b. and d. 1713.
 5. *Huldah*, b. Mar. 23, 1715; m., 1738, *Isaac Steadman*.
 6. *James*, b. Ap. 21, 1717; m., 1742, *Jerusha Park* [12-1], and settled in Worcester.
 - 7 and 8. two still-born daughters, 1720.
(By 2d wife, Sarah.)
 9. *Sarah*, b. Mar. 9, 1722, d. 1735.
 10. *Margaret*, b. Ap. 16, 1724; m., Ap., 1749, Dr. *John Druce*, grad. Harv. Coll. 1738, and settled in Wrentham. 6 chil. He d. aged 55, and his wid. Margaret m. — Blake.
 11. *Beulah*, b. Aug. 29, 1726; m. (1st), Oct. 9, 1750, at King's Chapel, Boston, *Stephen Winchester, Jr.* She d. Mar. 21, 1762, and he m. (2d), Feb. 19, 1764, wid. *Hannah Aspinwall*, b. July 20, 1740, dr. of Samuel and Hepzibah (Dana) Hastings, of Newton [m., in 1761, to Caleb Aspinwall, of Brookline]. By wife Beulah 9 chil.
 12. *Thaddeus*, b. Nov. 20, 1728; of Newton; m., Nov. 20, 1749, *Mary Craft*, b. Ap. 11, 1731, dr. of Lieut. Moses and Esther (Woodward) Craft, of Newton. Chil., 1. *Mary*, b. Nov. 1, 1750; m. Joseph Hall, of Sutton. 2. Edmund, b. Oct. 30, 1752, a Capt., of Newton; numerous descendants. 3. Samuel, b. June 24, 1757; m., (1st), Feb., 1781, *Elizabeth Bond* [358], who d., 1814, and he (Samuel) m. (2d), Ruth, wid. of Capt. Edm. Trowbridge.
 13. *Abigail*, b. Oct. 12, 1732, d. 1738.

TRUESDALE.—Dec. 8, 1761, caution against (settlement of) Richard Truesdale and wife, and 4 chil., viz., Elizabeth, Benjamin, Hannah, and Samuel, from Newton, in August. [Jackson, p. 427.]

- p. 611. **UPHAM.**—[1.] See Geneal. Reg. vii., p. 178. John Upham, Sen., m. (2d), Aug., 1671, Catherine Holland, wid. of Angel Holland, of Boston.
- p. 612. [15.] Hannah Upham m., prior to 1653, William Ballentine. She m. (2d), after 1669, William Long. She was a witness in Court, "Nov. 1679, aged about 44 years,"
- p. 613. [4.] For (IV.) read (V.) Martha Williams, 3d wife of Dea. Thomas Upham, was b. Aug. 27, 1743, and was a dr. of Jonathan and Deborah (Spring) Williams. [See Spring, [38], p. 937.
- p. 615. [31.] William Upham, of Weston, m. (2d), Nov. 9, 1728, Thankful Dana, of Roxbury.

-
- p. 616. **VAHEN.**—(Vaughan). John Vahen was an early proprietor of Watertown. 10 acres, which had been granted to him, he sold to Timothy Hawkins, by him sold to John Page, by him sold to Barnabas Windes, by him sold to John Stowers, and by him sold, Oct. 8, 1650, to Thomas Hammond. Previous to 1642, John Vahen had sold two lots of land to Edward How. Mar. 4, 1633-4, he was fined 20s. for disorderly conduct, which was remitted Sept., 1638. See also Col. Rec. I., pp. 284-5.

VELA.—John Vela had son John, bap. in Wat., Sept. 2, 1739; dr. Ann, bap. Sept. 12, 1742; son John, bap. Ap. 21, 1745. James Vela m. in Wat., May 4, 1762, Mary Stearns. [Was this Mary Stearns the wid. of Josiah Stearns? [137], p. 466.]

- p. 617. **WAITE**.—[1.] Admin. on wid. Mary Waite was granted to eldest son John, Ap. 2, 1679.
 [2.] Strike out, d. June 24, 1722. See [4.]
 Oct. 6, 1691, admin. on estate of John Waite granted to wid. Mary and son John.

- p. 618. **WALKER**.—[1.] The lot or farm which John Walker bought in 1712 of Ebenezer Chadwick, was bounded W. by land formerly of John Biscoe; N. by land formerly of Mr. Phillips and Nathaniel Whitney; E. by Daniel Galusha; S. by Jonathan Coolidge.
 p. 619. [14.] Sept. 10, 1765, caution against (settlement of) Richard Walker, from Boston, Oct. 1, 1764.

WARD.—Andrew Ward went from Wethersfield to Stamford, in 1640 or 41. He was one of the General Court (6 in number), at Hartford, who, on the 1st of May, 1637, declared war against the Pequods. Samuel Ward, of Wat., took the oath of fidelity in 1652. Dec. 11, 1737, William Ward, and wife Abigail, and Sarah, wife of Caleb Ward, were dismissed from Rox. to Waltham. [See Ward Family, p. 19, and Spring [16], p. 442.] Was it the wid. of this Wm. Ward who d. in Waltham, 1766? Mar. 13, 1738-9, caution against (settlement of) William Ward, from Boston, last August. Mar. 13, 1759, caution against (settlement of) Joseph Ward, from Newton, about June, 1758.

WARNER.—John Warner, Sen., and John Warner, Jun., were freemen of Farmington, Conn., Oct. 1669. Mar. 13, 1759, caution against (settlement of) Ebenezer Warner, from Springfield, in Feb. [See Stone [1], p. 950.]

- WARREN**.—[1.] The Will of John Warren, Sen., gives to son Daniel the 16 acres of land he now lives on; to dr. Mary Bigelow, 16 acres of land in lieu of township, now in her possession; to dr. Elizabeth Knapp, 16 acres of plowland, now in possession of her husband, James Knapp. The residue to sons John and Daniel [Prob. Rec. III., p. 345]. He appears to have agreed in religious sentiments with Dr. John Clark, of Newport, Nathaniel Briscoe, Sen., who returned from Wat. to England, Thomas Arnold, who moved from Wat. to Providence. They were probably all Baptists. See Clarke [1], pp. 741-2.
 p. 620. [5.] Elizabeth (Warren) Knapp. [See Knapp [7], p. 816.
 [6.] Daniel Warren was selectman 12 years, 1682-98.
 [15.] For 4.15 in the margin, read 2.15. The Will of Capt. John Warren, dated Jan. 12, proved Feb. 22, 1702-3, mentions wife Michal; sons John and Samuel; drs. Margaret and Elizabeth Warren; Mary, wife of Joseph Peirce, and Grace Warren.
 [16.] Margaret Warren, d. Dec. 16, 1742, aged 75, unm.
 [23.] Daniel Warren had only one wife, Elizabeth. See [35½], below. The dower of wid. Elizabeth was set off, Nov. 10, 1735. He had a grandson, Thomas Bruce, or Bruer.

[27½ and 28.] Several circumstances lead to the supposition that one of these (Jonas) should be Josiah,—the JOSIAH WARREN, of Westboro, who, by wife ELIZABETH had the following children.

1. MERAH, b. Nov. 26, 1719.
 2. ELIJAH, b. Dec. 23, 1721; m., Oct. 3, 1748, REBECCA HICKS.
 3. JONAS, b. Feb. 23, 1724, " Jr.;" m., June 19, 1746, HANNAH FORBUSH.
 4. SAMUEL, b. Dec. 14, 1725, drowned, 1727.
 5. AARON, bap. Dec. 24, 1727. 6. SAMUEL, b. Nov. 9, 1729.
 7. ELIZABETH, b. Nov. 2, 1731.
 8. SARAH, b. Jan. 13, 1733-4; m., July 12, 1757, SETH MORSE, Jr.
 9. ABNER, b. June 9, 1736, d. Feb. 5, 1761.
 10. ANNA, bap. May 21, 1738; m., Jan. 8, 1760, SETH GASPIT.
 11. LEVI, b. Mar. 29, 1741; of Westboro; pub. with " FEEBE SALSBEK," of Warren, July 13, 1764. He m. (pub. Feb. 21), 1769, DEBORAH PARTRIDGE, of Medway. He was adm. f. c. May 19, and she, June 2, 1771.
1. Oliver, b. Oct. 15, 1769. 2. Louis, b. Dec. 27, 1771.

3. *Lydia*, b. May 25, 1773. 4. *Elisha*, b. Feb. 19, 1775.

5. *Levi*, b. Jan. 6, 1777. 6. *Elijah*, b. Feb. 24, 1779.

[38.] Inventory of Ensign John Warren, Aug. 27, 1703, by Benjamin Garfield, Jonas Bond, and Josiah Jones, £276 18s. Admin. granted to his wid. Mary, Sept. 9, 1703.

[35.] Capt. DANIEL WARREN, m. in Wat., Feb. 26, 1711-12, REBECCA GARFIELD. It is conjectured that he is the one, whom Mr. Barry calls Samuel; that he first settled in Marlboro, and afterwards in Westboro. His wife Rebecca d. Oct. 2, 1720, and he m. (2d), in Westboro, Aug. 22, 1727, MARY WETHERBY. They were both adm. f. c. Aug. 27, 1738. She d. Jan. 18, 1738-9. It is not certain that the first three were his children.

1. DANIEL, b. in Marlboro, 1712, "Jr.," of Westboro; m. HANNAH —. She was adm. f. c. from Shrewsbury, Ap. 8, 1739, and he o. c. Jan. 27, 1740. Chil.,
 1. *Daniel*, bap. Jan. 27, 1740. 2. *Seth*, bap. July 28, 1741, d. next day.
 3. *Hannah*, bap. Aug. 28, 1742. 4. *Rebecca*, and 5. *Jemima*, bap. July 28, 1745.
2. REBECCA, d. Sept. 17, 1740.
3. TIMOTHY, b. in Marlboro, in 1715; of Westboro; m. (1st), REBECCA —. He m., (2d), PHEBE —. Chil.,
 1. *Timothy*, b. Mar. 28, 1740; m., Mar. 26, 1767, *Thankful How*. [Was it his wid. Thankful who m., Oct. 7, 1778, Solomon Bathrick?]
 2. *Joseph*, b. Ap. 24, 1742.
 3. *Rebecca*, b. Mar. 30, 1744; m., Oct. 6, 1767, *Daniel Stockwell*.
 4. *Benjamin*, b. July 21, 1745; (?) m. (pub. Ap. 4), 1767, *Lucretia How*.
 5. *Jemima*, b. Nov. 10, 174-; m., Jan. 27, 1770, *Solomon Woods*.
 6. *Ruth*, b. May 9, 1749; m., Sept. 12, 1778, *Isaac Ball*, of Southboro.
 7. *John*, b. Feb. 21, 1751, d. May 27, 1837; of Westboro; m., Oct. 28, 1779, *Annah Forbush*. Chil.,
 1. *Lovicy*, b. Aug. 3, 1780; m. Eli Forbes, June 12, 1803.
 2. *Caty*, b. May 2, 1782, d. Feb. 9, 1786.
 3. *Annah*, b. June 20, 1784; m., Nov. 28, 1805, Perpoint Brigham.
 4. *John*, b. Mar. 24, 1786.
 5. *Joel*, b. Ap. 17, 1788; m. (pub. Dec. 10, 1815), *Clarissa Johnson*.
 6. *Lucy*, b. May 12, 1790.
 7. *Caty*, b. Sept. 7, 1792; m., Mar. 28, 1816, Dexter Brigham.
 8. *Eunice*, b. Mar. 31, 1757; m. (pub. Feb. 20), 1780, *Stephen Belknap*.
 9. *Sarah*, b. May 1, 1759; m. (?) Dec. 15, 1783, *Stephen Maynard*.
 10. *Abner*, b. Mar. 15, 1761; m. (1st) Feb. 18, 1790, *Rachel Bond*. [264.] She d. Oct. 3, 1796, and he m. (2d), *Katherine* —. He d. Nov. 14, 1839. Chil.,
 1. *Josiah*, b. Mar. 26, 1792. 2. *Elijah*, b. Ap. 21, 1794.
 3. *Susanna*, b. Feb. 6, d. Sept. 28, 1796.
(By 2d wife, *Katherine*.)
 4. *Susanna*, b. Nov. 26, 1798. 5. *Rachel*, b. Dec. 13, 1799.
 6. *Elijah*, b. Sept. 21, 1802. 7. *Catherine*, b. Oct. 30, 1804.
 8. *Achsah Clarinda*, b. July 28, 1808.
4. JONAS, b. in Westboro, Nov. 16, 1717; of Westboro; m. LYDIA —. Chil.,
 1. *Sarah*. 2. *Lydia*, bap. June 2, 1745.
 3. *Susanna*, bap. Mar. 24, 1747.
 4. *Mary*, bap. Dec. 11, 1748. Afterwards this family moved to Upton.
5. SILAS, b. in W., July 28, 1720; m., Dec. 6, 1742, ELIZABETH NEWTON.
(By 2d wife, *Mary*.)
6. MOSES, b. Oct. 10, 1728; of Westboro; m., Jan. 24, 1750, PERSIS RICE, both adm. f. c. Nov. 30, 1752. He d. Oct. 20, 1765.
 1. *Daniel*, b. Nov. 12, 1751.
 2. *Persis*, b. Mar. 12, 1755; m., Dec. 7, 1771, *Daniel Adams*.
 3. *Moses*, b. Aug. 2, 1760; m. (pub. Sept. 14), 1781, *Rebecca Nurse*.
 4. *Lucy*, b. Feb. 7, 1762; m., Jan. 7, 1790, *Joseph Brigham*.
 5. *Dorothy*, b. July 2, 1764.
7. NAHUM, b. Sept. 25, 1730. 8. MARY, b. Sept. 12, 1732.
9. SUBMIT, b. Oct. 14, 1734. 10. JONATHAN.
11. SUBMIT, b. Jan. 13, d. Feb. 7, 1738.

[36.] The Will of Joshua Warren, of Waltham, dated Oct. 23, 1752, mentions wife Rebecca and all his children.

- p. 621. [38.] Joshua Warren, Jr. See Harris [11], p. 787.
- [38-3.] There was a Benjamin Warren (lineage not ascertained), who died in Littleton about 1776, leaving wid. Elizabeth and three dra. 1. Eusebe (wife of Peter Hoar). 2. Eunice (wife of Jonathan Hildreth). 3. Susanna. See [62], below.
- [40.] In 1725, Rebecca Warren, single, sued Joshua Warren, her father, admin'r of Caleb Church, for labor, Sept., 1711, to Mar., 1716, at £6 a year.
- [43.] Abigail Warren m., in Westboro, June 10, 1729, Jedediah How.
- [44.] For Uriah Rice, read Noah Rice.
- [46.] (?) Daniel Warren and wife Sarah were adm. f. c. from Worcester to Westboro, June 10, 1744; dr. Sarah, b. Ap., 1745, d. 1746.
- [47.] Samuel Warren lived on the homestead of his grandfather, John Warren, Sen.
- [52.] Ephraim Warren, a tailor, of Wat., in 1765 non-comp., and placed under guardianship.
- [56.] Ap. 5, 1720, John Warren, of Weston, was appointed guardian of his chil. by his wife Abigail, dr. of John Hastings, of Wat., d., viz., John, aged 19 yrs., Sarah, aged 18 yrs., Samuel, aged 17 yrs., and Thomas, aged 15 yrs. After his death, his eldest son, John, of Marlboro, was appointed, Jan. 31, 1731, guardian of his younger children.
- [57.] Will of John Warren, of Marlboro, blacksmith, dated Dec. 10, 1782, proved Mar. 10, 1784, mentions wife Zipporah, and chil., John, Elizabeth Brigham, Anne, wid. of Larkin Williams, Persis Arnold, Catherine Eager, and Thaddens.
- [60.] THOMAS and LYDIA (Mixer) WARREN settled in Westboro. Chil.,
1. Lydia, bap. in Westboro, Oct. 18, 1730. 2. Thomas, b. July 30, 1730.
 3. Joseph, b. Feb. 27, 1732; m., June 20, 1769, *Hepzibah Maynard*.
 4. *Elihalet*, b. Mar. 21, 1734; m. (pub. Ap. 12), 1763, *Miriam Rice*.
 5. Mary, and 6. Martha (twins), b. July 24, 1736. 7. Lucy, bap. Feb. 10, 1740.
 8. Lucy, b. Sept. 23, 1742; m. (pub. July 24), 1762, *Joseph Fay*.
 9. Thomas, b. Ap. 12, 1746.
- [61.] Either this David d. in infancy, or, what is more probable, it is an error in the record or copy of it, for Daniel, and may have been the following:
- DANIEL WARREN, m. in Wat., Dec. 20, 1733, MARTHA COOLIDGE (her parentage not ascertained). They immediately settled in Marlboro, where she o. c., Nov. 2, 1734, and was adm. f. c. Mar. 3, 1745. He d. Oct. 9, 1796, and his wid. Martha d. Dec. 28, 1801. Chil.,
1. Martha, b. June 12, 1734.
 2. Thaddens, b. Jan. 17, 1735-6; of Westboro; m. (1st), Aug. 18, 1759, *Abigail Whipple*. He m. (2d), May 5, 1768, *Hannah Gould*. Chil.,
 1. Abigail, b. Feb. 11, 1760.
(By 2d wife, Hannah.)
 2. John, b. Feb. 16, 1769. 3. Asaph, b. Jan. 9, 1779.
 3. *Neverson*, b. Feb. 17, 173-, d. Oct. 12, 1748.
 4. *Abigail*, b. Jan. 28, 1740.
 5. *Rebecca*, b. Dec. 3, 1741; m. (pub. Nov. 23), 1765, *Simeon Bellows*.
 6. *Sarah*, b. Nov. 19, 1743; m., Sept. 22, 1764, *John Boyd*, of Upton.
 7. *Hannah*, b. Aug. 25, 1745; m. (pub. June 4), 1763, *John Baker*.
 8. *James*, b. July 7, 1747. 9. *Neverson*, bap. Ap. 11, 1749.
 10. *Elizabeth*, b. Jan. 17, 1751. 11. *Daniel*, b. June 17, 1752.
 12. *Asaph*, b. May 30, 1755. 13. *Daniel*, b. Mar. 15, 1758.
- [61½.] The first child of John Warren, by 2d wife, Lydia, was Lydia, b. 1712.
- [62.] Benjamin Warren, of Wat., tailor, was, in 1736, guardian of his brother William, then aged 15, and his sister Beulah, aged 13. ☞ This sister Beulah, b. Aug. 23, was bap. Oct. 3, 1725, then aged 6 weeks. She m. (pub. Ap. 7), 1744, John Hobbs, of Brookfield. BENJAMIN WARREN settled in Westboro; m. JANE —. Chil.,
1. *Submit*, b. July 29, 1739. 2. *Elizabeth*, b. Mar. 7, 1741.
 3. *Annah*, b. Aug. 19, 1742. 4. (?) "*feern*," b. Mar. 2, 1745-6.
- p. 622. [77.] The Will of Dea. John Warren, of Weston, dated Mar. 23, 1744-5, mentions wife (not named); sons Josiah, Isaac, Elisha, and Ebenezer; dr. Mary Livermore, and drs. Prudence and Lydia Warren; 2 chil. of his dr. Sarah Harrington; Chil. of his dr. Anna Fiske, d.; to chil. of dr. Mary Livermore, each £20. Also mentions his father-in-law [step-father] Samuel Harrington, and appointed his eldest son, John, sole ex'r, assigned to him his homestead, &c., and required him to pay legacies.
- [39.] Isaac Warren was a tanner, of Camb.
- [55.] Ebenezer Warren, of Newton, m., in 1727, Elizabeth Hyde [? dr. of Jonathan and Elizabeth (Williams) Hyde], and had, 1. Esther, b. Nov. 28, 1727; 2. Samuel, b.

July 2, 1730; 2. John, b. Jan. 14, 1734. Guardians were appointed to his children, in 1747.

[89.] Strike out this line. [See Warren [62], above, p. 962.]

[91.] Ap. 8, 1738, the estate of Jonathan Warren, of Weston, apprizd and set off by Thomas Livermore, John Warren, Josiah Hobbs, John Jackson, and Samuel Livermore, to the following persons, viz.: wid. Sarah; dr. Kezia; Joseph Harrington, guardian of Anne, a minor; Daniel Carter, guard. of Sarah, Mary, Elizabeth, Submit, Thankful, and Abigail. As Tabitha and Grace are not mentioned in this distribution, they probably d. young. Why Eunice had not a share of the estate, the records do not show.

[92.] Tabitha Warren, m. Abijah Wheeler.

[96.] Grace Warren, m. — Harrison.

[97.] Anna Warren, m. Elisha Cox, of Weston, q. v.

[102.] Thankful Warren, m., May 11, 1750, Francis Cutting. [72-5.]

p. 623. [116.] The Will of John Warren, of Weston, dated May 6, 1784, proved Dec. 8, 1790, mentions a son Thomas. In the division of the estate, besides wid. Mary, are mentioned the following heirs, viz.: Cynthia, wife of John Cutting, Jedediah, Jonathan, Sarah, wife of Nathan Hobbs; Uriah, and Amelia, representatives of Thomas Warren, Maria Viles, Tryphena Furbush, Sukey Lyman, and Philemen.

[123.] In June, 1771, Josiah Warren, with wife Abigail, and son Josiah, moved from Wat., to Cambridge.

p. 625. [171.] For Russell Hubbard, read, Hubbard Russell.

p. 626. **WEBB.**—Dec. 9, 1718, caution against (settlement of) William Webb, from Medford to Watertown. Wid. Deliverance Webb d. in Wat., Dec. 20, 1758, aged 82 yrs.

WEEDE.—Jonas Weede, probably came over in the same ship with Sir Richard Saltonstall [Winthrop, II., p. 340], and accompanied him to Wat.; was adm. freeman May 18, 1631, and dismissed from Wat. Church to Wethersfield, May 29, 1635. Jonas Weed and John Weed, of Stamford, Conn., proposed for freemen, Oct., 1669.

p. 627. **WELLINGTON.**—[1.] Last line, for Gamb., read Camb. Roger Wellington, was selectman, 1678, 79, 81, 82, 83, 84, 91. [Note.] John Palgrave, son of Dr. Richard P., of Charlestown, m., Feb. 8, 1655-6, Mary Maverick, dr. of Samuel Maverick, of Noddle's Island. His wid. Mary, m., Sept. 20, 1660, Francis Hooke. [See Geneal. Reg., viii., p. 334.]

Roger Wellington

p. 628. [23.] Rebecca Wellington m. Oliver Wyman. [Wyman, 19, p. 670.]

p. 630. [69.] Edmund Wellington, m. (1st), Sept. 20, 1794, Eunice Adams.

p. 634. [114.] Dr. Timothy Wellington, d. suddenly, May 5, 1853. [See Geneal. Reg., vii., p. 295.]

[116.] Francis E. Wellington is a merchant, of N. York.

[118.] George Y. Wellington is a civil engineer, now (1858), in Indiana.

[128.] Mar. 8, 1756, the town (Weston) voted that Josiah Wellington shall have the North School house, to remove to his own land for a dwelling-house, for £4 13s. 4d.

p. 638. **WHEELER.**—Capt. Timothy Wheeler, m., for his 2d wife, Mary, only dr. of Capt. Thomas Brooks. [See Brooks, [42], p. 721.]

Sept. 11, 1764, caution against (settlement of) Ephraim Wheeler, wife Elizabeth and infant, from Boston, Feb. last. He o. c. in Wat., July 22, 1764, and same day dr. Elizabeth bap.; 2. Samuel, bap. Mar. 2, 1766; 3. James, bap. June 29, 1767. Nov. 25, 1697, Ephraim Wheeler, of Newton, and wife Sarah, sold to George Lawrence, 8 acres in Wat.

WHEELOCK.—Ralph Wheelock, A.B. Clare Hall, Camb., 1626; A.M. 1631. Sept. 27, 1642, he was appointed by the Gen. Court, clerk of writs, and one of the commissioners to end small causes, in Dedham; and in Oct., 1645, he was authorized to "solemnize marriages." John Crafts and Rebecca Wheelock, m., in Rox., June 7, 1654.

- p. 639. **WHITE**.—[See p. 806.] [†4.] Oct. 4, 1652, John White, of Boston, and wife Frances, sold to John Coolidge, 7 acres; a homestead, originally granted to Nicholas Buzby, by him sold to John Stebbins, and by him sold to John White. John White was one of the early settlers of Lancaster. [See Worcester Mag., II., p. 262.]
- [5.] Andrew White, d. May 12, 1742, and his wid. Sarah, d. Dec. 31, 1749.
- [6.] It is supposed that this Sarah White m. Thomas Hastings. [Hastings, 17, pp. 285, and 289.]
- [8-1.] William White, of Wat., was a drummer in Capt. Jonathan Brown's Co., at Lake George, in 1758. He m. Sarah Harris, dr. of Nathaniel Harris, Esq., of Wat., He lived successively in Groton, Wat., and Newton. [See Harris [36], p. 788.]
- [10.] Andrew White, Jr., was selectman of Wat., 1751 and 1762.
- [18.] Jedediah White, in 1757 or 8, belonged to Capt. Jonathan Brown's Co. He moved from Wat. to Waltham, in Dec., 1762; then to Wat., in 1764, and to Weston, last of Ap., 1770.
- p. 640. [19.] Paul and Lucy (White) Wyman. [See Wyman, 20, p. 679.]
- [32.] Samuel White was selectman of Wat., 1773, 74, 75, 76, 79, 86.
- [40.] Elijah White, wife, and dr. Hannah, moved to Little Camb., in June, 1771.
-
- p. 642. **WHITNEY**.—[1.] First line, for, at Ipswich, read, at London. John Whitney was elected constable of Wat., by the Court, June 1, 1641.
- [Note, 3d line, for 1655, read 1665.]
- p. 643. [7.] For Feb. 13, read, July 5, 1635.
- [10.] See Robert Reynolds, p. 912.
- [11.] For 1642, read 1643. John Whitney, of Rox., had, 1. John, b. Ap. 1, 1672.
2. Ruth, b. Aug. 31, 1674; m., Ap. 22, 1701, Joseph Adams. [See Jackson, p. 231.]
3. Sarah (by wife Elizabeth), b. Aug. 7, 1684.
- [DANIEL WHITNEY and SUSANNA CURTIS, m., in Rox., June 21, 1704. His parentage was not been ascertained, but his age, and the names of his children, render it probable that he was a son of John [11]. Chil.,
1. John, b. May 23, 1705. 2. Elizabeth, b. Feb. 4, 1706-7.
3. Susanna, b. Feb. 21, 1708-9. 4. Daniel, b. Mar. 26, 1711.
5. Anna, b. Ap. 30, 1713. 6. Elijah, b. Jan. 15, 1715-16.
7. Ruth, b. Dec. 5, 1718. 8. Elisha, b. Oct. 5, 1722.
- TIMOTHY WHITNEY, of Rox. (parentage not ascertained, perhaps a son of John [11]), m., in Rox., June 12, 1706, MARGARET BACON. In 1728, he purchased, for £615, of John Prentice, of Preston, Conn., and Ebenezer Prentice, of Newton, the farm and buildings in Newton, which had been the last residence of their grandfather, Thomas Prentice, Sen. [See Jackson's Hist. Newton, p. 463.] Chil. b. in Roxbury.
1. Sarah, b. Feb. 28, 1707-8.
2. Caleb, b. Ap. 2, 1711; of Newton; m., in 1736, Hannah Cheney, b. June 13, 1711, dr. of Joseph and Sarah (Wiswall), of Newton. Chil.,
1. Hannah, b. Mar. 3, 1737; m., 1772, Nathaniel Parker.
2. Caleb, b. June 17, 1740; m. Elizabeth Hyde. Chil.,
1. Oliver, b. Mar. 9, 1766. 2. Amariah, b. Nov. 18, 1767.
3. Ruth, b. May 31, 1773. 4. Sarah, b. June 4, 1774.
5. Abigail, b. Sept. 10, 1775.
3. Sarah, b. Oct. 23, 1743; m., 1769, James Richards, Jr.
4. Thaddeus, b. July 10, 1747; m., 1772, Temperance Hyde, b. Ap. 1, 1753, dr. of Lieut. Noah and Ruth (Seger). He d. 1832. She d. 1842. Chil.,
1. Temperance, b. Sept. 2, 1774; m., 1795, Jonathan Cook, Jr.
2. Hannah, b. Ap. 9, 1779. 3. Thaddeus, b. Sept. 1, 1788; d. 1823.
3. Moses, b. June 20, 1714; of Newton; m., 1739, Rebecca Hyde, b. Sept. 23, 1720, dr. of Ens. Timothy and Rebecca (Davis) Hyde, of Newton. He d. 1805, aged 91.
1. Margaret, b. May 8, 1741. 2. Moses, b. Ap. 9, 1743; d. in the army.
3. Mary, b. Feb. 1, 1745; m., 1765, Edward Richards, of Camb.
4. Timothy, b. Feb. 12, 1747; m., in 1773, Mary Hyde. He d. 1821.
5. Stephen (twin), b. Feb. 12, 1747; d. in the army.
6. Elizabeth, b. May 30, 1749; m., 1777, Asa Payson.
7. Ephraim, b. June 16, 1751; m., 1774, Ann Fuller, and d. in the army.
8. Rebecca, b. Mar. 17, 1754; m., 1780, William Buzzard.
9. Relief, b. Dec. 29, 1756; m., in 1783, John Woodward, of Brookline.

10. Gershom, b. July 25; 1758; d. 1759.
 11. Persis, b. Feb. 19, 1760; m., 1797, James Richards.
 12. John, b. Ap. 8, 1762; m., 1785, Polly Pope.
 4. Joseph, b. Feb. 21, 1716-17; of Newton; m. *Mary Hastings*. [?39.] Chil.,
 1. Abigail, b. Dec. 18, 1749. 2. Martha; b. May 31, 1752.
 3. Ann, b. Feb. 10, 1755. 4. Samuel, b. Aug. 7, 1758.
 5. Lois, b. Sept. 5, 1761.
 6. Timothy, b. Ap., 1720. 6. Timothy, b. Ap. 30, 1721.

Elnathan Whitney and Sarah Perry, m., in Rox., Sept. 24, 1739.

Jonas Whitney and Sarah Perry, m., in Rox., May 8, 1735.

John White and Esther Whitney, m., in Rox., Mar. 8, 1745-6.

[21.] Ap. 7, 1691, Richard Whitney, of Stow, "being seventy years of age," was released from training, by the Court.

p. 644. [40.] Jonathan Whitney took the oath of fidelity, in 1652.

[49.] Oct. 29, 1697, Joshua Whitney, of Groton (? Sen. or Jun.), sold land in Wat., to Nathan Fiske.

[56.] ISAAC WILLIAMS, b. in Newton, Nov. 1, 1686, son of Capt. Isaac and Elizabeth, m., in Groton, Feb. 1, 1708-9, MARTHA WHITNEY [56], dr. of Joshua Whitney, of Groton. [See Williams Family, p. 157.] His Will mentions wife Martha; sons, Jonathan and Isaac; drs., Elizabeth Reed, Abigail Fuller, Mary Miller, and Hannah Rogers; gr. chil., Ephraim, Nathaniel, and Martha Spring. Chil.,

1. Abigail, b. Oct. 4, 1710; m. Josiah Fuller [144, p. 770], son of Jeremiah Fuller, of Newton.
2. Jonathan, b. Dec. 16, 1711; m., 1735, Deborah Spring [38]. Chil.,
 1. Jonathan, b. 1, and d. 18 July, 1737. 2. Deborah, b. July 20, 1738.
 3. Phebe. 4. Joanna, b. Oct. 20, 1741; m., Oct. 14, 1765, John Cheney.
 5. Martha, b. Oct. 27, 1743.
3. Martha, b. Mar. 18, 1714; m., Dec. 10, 1741, Nathaniel Spring [39]. Chil.,
 1. Ephraim, b. in Worcester, Sept. 24, 1742. 2. Nathaniel. 3. Martha.
4. Mary, b. June 14, 1717; m., 1741, Joseph Miller, of Newton.
5. Phebe, b. Oct. 9, 1723.
8. Hannah (twin), b. Oct. 9, 1723; m., in, 1745, John Rogers.
7. Isaac, b. July 15, 1725; m. (1st), June, 1748, Sarah Stratton, of Camb. He m. (2d), Jan. 3, 1765, Elizabeth Cheney, of Newton. Chil.,
 1. Sarah, b. Aug. 27, 1750. 2. Abigail, b. July 10, 1752.
 3. Ephraim, b. Feb. 25, 1760. 4. Pattee, b. Nov. 2, 1763.
 (By 2d wife, Elizabeth.)
 5. Amariah, b. Aug., d. Nov. 22, 1765. 6. Elizabeth (twin), b. Aug. 25, 1765.
 7. Asa, b. June 7, 1773.
8. Elizabeth, b. ———; m. Josiah Reed.

[57.] Elizabeth Whitney, m., in Groton, Ap. 17, 1707, Ebenezer Farnsworth. 8 chil., and numerous descendants. [Butler, p. 396, &c.]

p. 645. [70.] Joseph Whitney took the oath of fidelity, Dec., 1677. Admin. on his estate granted to wid. Martha, Nov. 30, 1702; Inventory, of the same date. Guardianship of his son Benjamin, given to Isaac Beech, of Newton, and that of Mary and Sarah, to wid. Martha.

p. 646. [90.] For, bap., read Jonas, o. c. July 14, 1723.

- | | |
|--------|--|
| 1 | [107.] (V.) NATHANIEL WHITNEY, Jr., of Weston, m., in Weston, June 22, 1721, MARY CHILD. of Wat. (supposed to be a dr. of John Child [18.]). They settled in Westboro, where he and wife was adm. f. c. Jan. 21, 1728. He had o. c. in Concord, Oct. 15, 1727. He d. Jan. 27, 1776, æt. 80, and his wife d. Dec. 3, 1776, æt. 77. Chil., |
| 2 | 1. Ephraim, b. July, 1722. (The Weston Record says, b. in Groton, June 22.) |
| 3 | 2. Oliver, b. Dec. 1, 1724. |
| 4 | 3. David, bap. in Weston, Nov. 8, 1726 (church record). |
| 5 | 4. Mary, b. Feb. 15, 1727; adm. f. c. in Westboro, June 10, 1743. |
| 6 | 5. Nathaniel, b. July 22, 1728. 6. Astna, b. Mar. 8, 1730. |
| 8 | 7. Amos, b. Mar. 17, 1732. 8. Lucy, b. Ap. 26, 1734. |
| 10 | 9. Lane, b. Sept. 16, 1736; m. (pub. Mar. 30), 1772, John Taft, of Upton. |
| 13. 11 | 10. [redacted], b. Feb. 9, 1738-9. 11. Eli, bap. May 8, 1740. |

12. 13 (VI.) ELI WHITNEY, of Westboro, m., Feb. 9, 1765, ELIZABETH FAY. Both adm. f. c., Dec. 6, 1767. She d. Aug. 18, 1777, æt. 37. He m. (2d), (pub. June 12), 1779, JUDITH HAZELDEN, of Sutton. He d. Aug. 12, 1807, aged 66. Chil.,
- 14 1. *Eli*, b. Dec. 8, 1765; grad. Yale Coll., 1792; d. Jan. 8, 1825. ☞ He was inventor of the cotton gin.
- 15 2. *Elizabeth*, b. Ap. 16, 1767; d. Feb. 8, 1827, aged 60.
- 16 3. *Benjamin*, b. Sept. 13, 1768; d. Dec. 26, 1842, aged 77, last of the family.
- 17 4. *Josiah*, b. Mar. 31, 1770.
- p. 648. [178.] Ensign Daniel Whitney was selectman of Wat., 1751, 55, 57, 59, 60, 61, 62.
- p. 650. [251.] For John Fisher, of Lynn, read John Fisher Lyon, of Grafton, afterwards of Shrewsbury, after that of Harvard.

p. 651. **WHITTEMORE.**—(Whitamore, Whitamore, Whitmore, Wetmore, &c.) Mr. Farmer appears to consider these names as only a varied orthography of one name. Those, however, who have carefully investigated the subject, have concluded that there were three distinct names and families (Whittemore, Whitmore, and Wetmore), between whom, there has been discovered no early consanguinity. Gentlemen are now engaged in investigating the genealogy of the Whittemores and Whitmores, and will probably fully elucidate this subject. On pages 652 and 53, under one name (Whittemore), are mentioned families, who were distinct in their name and lineage; one portion of them being Whittemores, and the other Whitmores. We here insert so much as to correct the error referred to, with a little additional information.

JOHN WHITTEMORE (4th child of Thomas and Hannah Whittemore, of Charlestown), m. (1st) MARY UPHAM. [Upham, †2.] She was adm. f. c., in Charlestown, Mar. 12, 1670-1, and d. June 27, 1677. He m. (2d), Nov. 8, 1677, MARY MILLER, dr. of Rev. John Miller, of Yarmouth. She was probably the wid. Mary Whittemore, who d. in Wat., Jan. 28, 1731-2, æt. 78. Chil.,

1. *John*, b. about 1662.
2. *Thomas*, b. Sept. 1, 1664; d. in Wat., Aug. 10, 1717, aged 52 yrs. 10 m. 10 d. [gravestone.] He m. *Mary*, wid. of Samuel Pease, of Boston. [Mid. Prob., 1724.] John Biscoe [19.] and wife Sarah, on 13th Oct., 1712, sold to Thomas Whittemore, of Camb., 20 A. of land in Watertown. About the date of this sale, John Biscoe moved to Cambridge. Chil.,
 1. *Thomas*, b. Mar. 18, 1694; m., in Boston, in 1715, Dorothy Thomas. He d. soon, leaving one child, Thomas, who, with his widowed mother, was bap., Sept. 1, 1717. His wid. m. Robert Jennison. [15.]
 2. *Martha*, b. Ap. 17, 1709.
3. *Joseph*, b. Jan. 29, 1666; m. (1st) *Joanna Mousal*. He m. (2d) *Susanna Frost*.
4. *Benjamin*, b. Sept. 1, 1669; of Concord; m. *Esther Brooks*. [See Brooks, [16,] p. 720.] He d. Sept. 8, 1734.
5. *Nathaniel*, b. Mar. 9, 1673. 6. *Joel*, d. Ap. 27, 1677.
7. *Joel*, b. June 15, 1677.
(By 2d wife, Mary Miller.)
8. *Mary*, b. Oct. 24, 1678.
9. *Pelatah*, b. May 7, 1680; d. Oct. 21, 1724; m. *Elizabeth Eustis*.
10. *Amos*, b. July 25, 1681; d. Oct. 25, 1709. 11. *Elizabeth*, b. Sept. 26, 1683.
12. *Daniel*, b. Dec. 28, 1685; d. Mar. 27, 1686. 13. *Rebecca*, b. Mar. 3, 1687.
14. *Hannah*, b. Feb. 10, 1689. 15. *Daniel*, b. in Wat., May 17, 1691.

DANIEL WHITTEMORE (another son of Thomas and Hannah, of Charlestown), m. MARY ——. She d. May 11, 1683. Chil.,

1. *Daniel*, b. Ap. 27, 1663; d., Sept., 1756; m. *Lydia Bassett*, dr. of Joseph and Martha (Hobart) Bassett, of Bridgewater.
2. *John*, b. Feb. 12, 1665; m., 1692, *Ruth Bassett*, sister of his brother Daniel's wife. He d. probably in 1731. Chil.,
 1. *John*, b. Sept. 12, 1694; of Leicester; m., Nov. 18, 1711, Elizabeth Lloyd.
 2. *Jeremiah*, b. 1695. Jeremiah Whittemore, "of Charlestown," and Patience Reed, of Woburn, m., in Woburn, Mar. 15, 1722. [Wob. Town Record.] See p. 653.
 3. *Benjamin*. 4. *Patience*. 5. *David*, b. Ap. 6, 1706; m. *Alice* ——.
 6. *Deborah*, b. Mar. 1, 1708. 7. *Pelatah*, b. Oct. 20, 1710, Dunstable.
3. *Thomas*, b. Mar. 5, 1667. 4. *Mary*, b. Feb. 12, 1668. 5. *Nathaniel*.

WHITMORE.—FRANCIS WHITMORE, of Camb., b. 1625, adm. freeman, May 3, 1654; m. (1st) ISABELLA PARK, dr. of William Park, of Rox. She d. Mar. 31, 1665, and he m. (2d), Nov. 10, 1666, MARGARET HARTY. He d. Oct. 12, 1685, and his wid. d. Mar. 1, 1686. Chil.,

Francis Whitmore
J. Nobell reg. Whitmore

1. Elizabeth, b. May 2, 1649; m. Daniel Markham.
2. Francis, b. Oct. 12, 1650; of Middletown, Conn.
3. John, b. Oct. 1, 1654; of Medford.
4. Samuel, b. May 1, 1658; of Lex.; m. (1st), Mar. 31, 1686, Rebecca Gardner. She d. June 5, 1709, set. 40, and he m. (2d) Mary, wid. of Abraham Watson. Chil.,

Samuel Whitmore

1. Francis, b. in Camb. (Lex.), Dec. 9, 1686; bap. in Wat., May 24, 1691.
2. Samuel, b. Ap. 1, 1688; bap. in Wat., May 24, 1691; m., in Lex., Jan. 7, 1719–20, Bethia Page, and had son Daniel, b. Feb. 15, 1724–5. He d. Aug. 17, 1724, aged 37.

Samuel Whitmore Junr?

3. Rebecca, b. in Lex., Feb. 9, 1690–1; bap. in Wat., May 24, 1691; (?) m. Thomas Wellington [22].
4. Abigail, b. May 8, 1698.
5. John, d. Jan. 15, 1714–15.
6. Benjamin, b. 1700; d. 1754; of Newton; m., 1729, Elizabeth Cheney, and had, 1. John, b. June 29, 1730; m. Beulah —, and had chil. 2. Joseph, b. Oct. 13, 1732. 3. Sarah, b. June 29, 1735; m. John Hagar. [20–2.]
7. Sarah, b. Ap. 10, 1701; m. Timothy Hyde.
8. Nathaniel, b. May 7, 1702; of Newton; m., 1724, Abigail Parke [+20]. 3 chil.
9. Mary, b. May 4, 1704.
5. Abigail, b. July 3, 1660; m. — Wilcox.
6. Sarah, b. Mar. 7, 1662; m., May 29, 1683, Dea. William Locke, Jr. [Locke Fam. p. 16.]

(By 2d wife, Margaret.)

7. Margery, b. Sept. 9, 1668; m. Thomas Carter.
 8. Frances, b. Mar. 3, 1671; m. Jonathan Thompson.
 9. Thomas, b. 1673; of W. Killingby, Conn.
 10. Joseph, b. 1675; of Woburn.
- p. 653. [3–i.] For 1779, read 1797.

p. 654. **WILLEY.**—Mar. 13, 1710–11, and again, 1715, caution against (settlement of) Elizabeth Willey, from Boston.

WILLIAMS.—2d line, for adm. freeman, read, took the oath of fidelity. Feb. 26, 1655–6, Abraham Williams, for himself, his mother, his brother, and brother's wife, were notified in Wat., concerning swine [town record].

- [1.] Rev. William Williams d. Mar. 6, 1760, aged 72.
- [13.] Abigail Williams, wife of Rev. W. W., dismissed from Norton to Waltham, June 8, 1728.

p. 655. [19.] William Williams, son of Isaac, Jr., of Newton, was constable of Wat. in 1737. He had 1. Abijah, 2. William, 3. Abijah, 4. Elisha, born in Newton before he moved to Watertown.

WINCHESTER.—For [Bisco, 25] read [Bisco, 32.] See p. 685. Grace, wife of William Winchester, d. Mar. 29, 1822, aged 54.

WINCOLL.—Nov. 2, 1649, Thomas Wincoll was, by the selectmen, allowed to keep a house of entertainment. It is probable that John Wincoll had a temporary residence at Kittery about 1652; and finally left Watertown about 1662.

WINDES.—(Wines.) Barnabas Wines, Jr., "accepted as freeman of Conn., in 1664"

[see Hinman, p. 198]. There was a near relationship between this family (Wines) and that of John Benjamin, Sen. [see Benjamin, 2]. Goodman Wines and Barnabas Wines, Jr., adtp. freemen at Southold, L. I., 1662 and 64.

WINGE.—Embarked at Ipswich, Eng., Ap. 1634, in the Francis, John Cutting, master [with other Wat. families], Robert Winge, aged 60, and wife Judith, aged 43. Perhaps this Judith was the wid. Winge, who d. in Wat., Oct. 19, 1686.

WINTER.—Samuel Winter, of Killingly, m., in Groton, Feb. 16, 1713–14, Elizabeth Philbrook, b. Nov. 18, 1690, dr. of Ephraim and Elizabeth, of Groton.

p. 657. **WOODWARD.**—[2.] In Ap., 1669, George Woodward was a witness in Court, then aged 50 years, which shows that he was aged 15 at the time of embarkation, and two years older than his brother John. He was selectman in 1674.
[5.] The Will of Amos Woodward also mentions brother Nathaniel Patten; brother John Woodward; sister — Waite; sister Sarah Gates (? Yeates); sister Rebecca Fisher; my loving brother and friend, Dea. Cooper, and Dea. Hastings, ex'rs. Dea. John Stone and brother Richard Robbins, overseers.

[11.] (III.) GEORGE and LYDIA (BROWN) WOODWARD. Chil.,

- 2 1. ABRAHAM, b. in Wat., Feb. 1, 1687–8; of Brookline; m. (1st) JOANNA HARRIS, b. May 28, 1690; dr. of Daniel and Joanna (Brown) Harris [see Harris [9,] p. 787]. He m. (2d), June 4, 1728, wid. SARAH PIERPONT, of Roxbury. Chil.,
3 1. Abraham, b. Jan. 12, bap. in Rox., Jan. 19, 1718; m. in Rox., June 23, 1743, Sarah Letheridge. Chil.,
1. Hannah, b. in Rox., Ap. 19, 1744. 2. Abraham, b. Feb. 12, 1745–6.
3. Caleb. 4. Samuel. 5. Nancy.
8 2. Joanna, bap. Aug. 16, 1719. 3. Benjamin, bap. Aug. 18, 1723.
(By 2d wife, Sarah.)
24.9 4. Caleb, b. July 25, 1729, d. Nov. 1772, aged 44.
10 5. Joshua, bap. Feb. 21, 1731, in Brookline, d. Nov. 11, 1776, of small-pox, unm.
11 2. GEORGE, mentioned in the distribution of his father's estate; probably settled in Mendon. [See †13, p. 658.]
78.12 3. NATHANIEL, m. DORCAS GARDNER; moved to Connecticut.
13 4. LYDIA, m. ROBERT HARRIS, brother of her brother Abraham's wife. [See Harris, [18,] p. 787.]
14 5. ICHABOD, of Brookline, m. July 1, 1725, ABIGAIL HOLBROOK, of Roxbury. Chil.,
15 1. Abial, b. Ap. 12, 1726; m., Oct. 15, 1747, Daniel Seaver, of Rox. Chil.,
16 1. Abigail, b. June 2, 1748. 2. Thomas, b. Nov. 10, 1750.
18 3. Daniel, b. July 4, 1753. 4. Lydia, b. Mar. 14, 1756.
20 5. Ichabod, b. Feb. 27, 1759. 6. Elisha, b. July 27, 1761.
22 7. William, b. Oct. 19, 1765. 8. Susanna, b. Jan. 25, 1770.

9.24 (V.) CALEB WOODWARD, of Roxbury, m., Nov. 21, 1751, HANNAH CHEEVER, of Rox.

- 25 1. HANNAH, b. Jan. 27, 1753; m. EBENEZER BARTLETT, and moved to Blandford, Mass.
26 2. LYDIA, b. July 22, 1754; m. THADDEUS JACKSON, of Rox. Chil.,
27 1. Nancy. 2. Nabby. 3. Susanna. 4. Lydia. 5. Thaddeus. 6. Hannah.
7. Esther. 8. Pedy, m. John Woodward [65]. 9. Amasa. 10. Catherine, m. Jesse Woodward [64]. Nine of these m., and eight of them had children.
37 3. SARAH, b. Feb. 18, 1756; m. — PEASE, of Boston, d. s. p.
38 4. ABIGAIL, b. 1758; m., Aug. 12, 1774, EPHRAIM WILSON. Chil.,
1. Edward. 2. Daniel. 3. Caleb. 4. Abigail. 5. Hannah. 6. David.
5. MARY, b. Oct. 5, 1760, d. young.
46 6. CALEB, b. Sept. 9, 1762; m. SALLY FOSTER; moved first to Bellingham, and about 1787, to Washington, N. H., where he is still living; said to have been a very active and enterprising farmer. He m. a 2d wife. Chil.,
47 1. Benjamin, b. in Bellingham, May 19, 1786; m., 1812, Jane Weeks, of Newstead, (?) Penn. 4 chil.

- 46 2. *Nancy*, b. in Washington, Ap. 11, 1788, d. July 17, 1830; m. *Asa Spalding*,
an orthodox clergyman; now (1854) living. Chil.,
1. Alpha 2. Willard, a Universalist clergyman. 3. Asa.
- 52 3. *Caleb*, b. Dec. 24, 1789; m. (1st), his cousin, *Betsy Woodward* [73]. He
m. (2d), in 1814, *Hannah Carey*, of Buckfield, Me. Chil.,
53 1. Eliza Ann, b. in Brookline, June 11, 1816; m., about 1844, John A.
Warren. 4 chil.
- 54 2. Henry A., b. in Dedham, Ap. 26, 1819; m. in 1846, Mary Ford.
3. Relief, b. in Oxford, Me., Mar. 5, 1822, d. 1823.
(By 2d wife, Hannah.)
- 55 4. W. Elliot, b. in O., Nov. 29, 1825, now of Rox.; m., June 26, 1848,
Clariassa E. Boys, at Norfolk, Conn.
5. Caleb L., b. in O., Aug. 20, 1829, d. Feb. 24, 1832.
6. Mary Eleanor, b. Feb. 8, 1831, d. Feb. 24, 1832.
7. Charles L., b. Aug. 20, 1833.
- 56 4. *John*, b. Mar. 8, 1792; m. in Wilmot, N. H., *Almira Graves*. He and
57 numerous children d. early.
- 58 5. *Sally*, b. May 16, 1795; m. *Charles Lowd*. Chil.,
59 1. Francis, b. Nov. 30, 1818. 2. Charles, b. Dec. 10, 1822.
- 61 6. *Olive*, b. Aug. 31, 1798, d. Feb. 3, 1810.
7. *Eliot*, b. Nov. 26, 1801, d. Jan. 18, 1833.
(By 2d wife.)
- 62 8. *Thomas P.*, b. Jan. 1, 1822; m., and lives with his father.
- 63 7. JOHN CHEEVER, b. Mar. 11, 1764; of Brookline; m. RELIEF, dr. of Moses
Whitney, of Newton. Chil.,
64 1. *Jesse*, b. Ap. 7, 1784; m. *Catherine*, dr. of Thaddeus and Lydia (Woodward)
Jackson [see 26]. 3 drs.
- 65 2. *John*, b. Dec. 24, 1785; m. *Pedy Jackson*, his cousin. See [34]. Chil.,
66 1. Lydia, b. Mar. 21, 1808; m. in 1833, Simon W. Clifford. 3 chil.
2. John, b. Ap. 11, 1811, d. Feb. 25, 1816.
67 3. Julia, b. Aug. 27, 1813; m. Warren Guild, of Dedham. 3 chil.
68 4. Andrew, b. Ap. 7, 1815; m. Sarah Stone. 2 chil.
69 5. Experience, b. May 1, 1819; m. B. Craig.
70 6. Martha E., b. Dec. 19, 1826. 7. Mary Jane, b. July 27, 1828.
72 8. John, b. Sept. 3, 1833.
- 73 3. *Joshua*, b. Ap. 24, 1788, d. aged 18 yrs.
4. *Betsy*, b. Aug. 20, 1790; m. her cousin, *Caleb Woodward* [52].
5. *Daniel*, b. Nov. 11, 1793, d. 1796. 6. *Daniel*, b. Nov. 29, 1797, d. young.
- 74 7. *Nancy*, b. Oct. 14, 1798; m. Oct., 1821, *Nathaniel Talbot*, of Newton. Chil.,
75 1. David, b. Feb. 18, 1822; m., Mar. 20, 1845, Mary G. Gregory. 4 chil.
76 2. Susan M., b. Oct. 1826, unm.
77 3. Asa, b. July 26, 1828; m., Nov., 1850, Rebecca Harrington.
-
12. 78 (IV.) NATHANIEL WOODWARD, 3d child of George and Lydia (Browne)
Woodward, of Brookline, m., in Rox., June 23, 1715, DORCAS GARDNER. He
probably settled in Brookline, although the births of his children are recorded in
Roxbury town records. It is said he moved first to Brooklyn, Conn., and, about
1734 or 35, settled in Coventry, Conn. His five children, all by his first wife,
were born before he went to Connecticut. His wife Dorcas d., and he m. (2d), wid.
— TOPLIFF, with whom he lived about two years. He m. (3d), wid.
PATTEN, and moved to Stafford, Conn., where she owned a farm, and where
he d., Mar., 1772. He was a blacksmith, and became a large landholder. He
settled in the N. E. part of Coventry, near the line of Tolland. Chil.,
84. 79 1. NATHANIEL, b. May 26, 1716; birth recorded in Rox.
- 80 2. DORCAS, b. Feb. 11, 1719 (birth recorded in Newton); m. (1st), JOHN ABRON,
son of Samuel and Martha Abron, of Tolland, Conn. He was killed by light-
ning in Ellington, aged about 40. She m. (2d), in 1772, JOHN WILLIAMS, of
Wilbraham, and d. 1774.
- 81 3. MOSES, b. in Newton, June 7, 1721, d. aged 19 yrs. 4. AARON.
137. 83 5. ANNA, b. in Rox. 1727; m., in 1750, SAMUEL LADD, and d. 1808.

- 79.84 (V.) NATHANIEL WOODWARD, m., 1742-3, ELIZABETH, dr. of Samuel and Martha Aborn, of Tolland, Conn. He d. Ap. 15, 1792, aged 75 yrs., 10 m. 21 d., and his wid. Elizabeth d. Ap. 25, 1808, aged 84. Chil.,
- 85 1. Moses, b. Mar. 30, 1745; m. ABIGAIL WEST, of Tolland. 9 chil., of whom two d. in infancy.
- 85½ 1. *Erastus*, d. aged 16 yrs.
- 86 2. *Billa*, b. 1772; a farmer; m. *Polly Steel*, of Tolland; d. in Roxbury, Vt., in 1851, leaving 8 chil. residing there.
- 86 3. *Luke*, b. 1774; m. *Mary Howard*, and now (1854), resides in Jefferson, Vt. 9 chil.
- 87 4. *Abigail*, b. June, 1778; m. *Amos Booth*; d. about 1800, leaving 3 children.
- 88 5. *Solomon*, b. 1784; a blacksmith, of Springfield, Mass., where he d. about 1833. He m. *Dorcas Malden* of N. Hampshire, and left sons *Erastus*, *Nathaniel*, *Solomon*, and *Asa M.*, now (1854), residing in Springfield.
- 89 6. *Ether*, b. 1787; m. *Ichabod Munsel*. She d. about 1827. 6 chil.
- 90 7. *Erastus*, b. 1790; a merchant, of N. Y. city; m. about 1820; d. in 1834, leaving 4 chil.
- 91 2. ELIZABETH, b. Aug. 28, 1747; m., 1769, GAD HUNT, of Coventry, b. Jan. 16, 1749. He d. May 26, 1806, and his wid. d. July 13, 1829. Chil.,
- 198.92 1. *Ether*, b. Mar. 10, 1771; m., in 1800, *Miner Cobb*.
- 205.93 2. *Gad*, b. Ap. 14, 1773; d. Mar. 12, 1835.
- 210.94 3. *Sanford*, b. Ap. 17, 1777; d. 1849, at Hunt's Hollow.
- 95 4. *Clarissa*, b. Nov. 22, 1779; m., Nov. 23, 1809, *Axel Goodwin*, of Coventry, where she is now (1853) living. Chil.,
- 96 1. *Clarissa* Hunt, b. Feb. 6, 1811.
- 97 2. *Eveline*, b. Ap. 21, 1815; m. *Porter Edwards*, of Hartford, Conn.
- 98 3. *Henry Sanford*, b. ———; m., June 2, 1846, *Ann French*. Chil.,
- 99 1. *Charles H.*, b. Sept. 10, 1847. 2. *Horace* Hunt, b. June 9, 1851.
- 100 4. *Charles Fayette*, b. Aug. 30, 1824.
- 101 5. *Elijah*, b. Sept. 20, 1782; of Coventry; m. *Mahitabel Dexter*. He d. June 16, 1807. Chil.,
- 101 1. *Hannah* Hall, b. Mar. 23, 1805; m., May 17, 1829, *Joseph Wilson*, and had one child, *Elizabeth*.
- 102 2. *Horace* Stoughton, b. Mar. 13, 1807; of Rodman, Jefferson Co., N. Y.; m., Ap. 4, 1832, *Harriet L. Bailey*. 4 sons and 6 drs.
- 320.103 6. *Horace*, b. June 5, 1788.
- 104 3. *ESTHER*, b. Aug. 24, 1749; d. Aug. 29, 1756.
- 104 4. NATHANIEL, b. June 23, 1752, O. S. (July 4, N. S.); m., May 31, 1781, ZERVIA ENSWORTH. He d. May 27, 1828, and his wife d. same day. Chil.,
- 105 1. *Nathaniel*, b. Oct., 1782; d. Ap., 1783.
- 106 2. *Nathaniel*, b. Feb. 5, 1784; a cooper; d. Oct. 18, 1843.
- 107 3. *John*, b. Ap. 5, 1786; a farmer; d. Feb. 7, 1851.
- 107 4. *Hannah*, b. Jan. 31, 1788; m. (1st), Ap. 30, 1807, *Ichabod Gurley*, of Mansfield, Conn., who d. Mar. 26, 1814. She m. (2d), Jan. 31, 1816, *Salmon Blackman*, of Bridgewater, N. Y. By 1st husband, 3 chil.; by the 2d husband, 2 chil.
- 108 5. *Anne*, b. Feb. 1, 1790; d. Mar. 13, 1815.
- 109 6. *Fanny*, b. Ap. 1, 1792; m., in 1807, *Eleazer French*. 8 chil.
- 110 7. *Daniel*, b. Dec. 10, 1793; m., Jan. 6, 1820, *Lydia Edgarton*. He d. Jan. 6, 1827. Chil.,
- 111 1. *George E.*, b. Oct. 5, 1820; m., Sept. 1, 1851, *Martha M. Blish*.
- 112 8. *Sarah*, b. May 10, 1796.
- 112 9. *Wealthy*, b. May 16, 1798. These two sisters, unm., now reside on the paternal estate, which has been in the occupancy of 4 of the name of *Nathaniel*, in successive generations.
- 113 5. LYDIA, b. Aug. 19, 1754; m., 1777, JOHN BARCOCK. She d. May 19, 1849. Chil.,
- 114 1. *Hannah*, b. June, 1778; m. *John C. Carpenter*, of Manlius, N. Y. She d. Nov., 1840; left one child.
- 115 2. *Lydia*, b. 1780; m. Col. *John Sprague*, of Fayetteville, Onondaga Co., N. Y., a.p.
- 116 3. *Dianthe*, b. 1782; m. *Walter Loomis*. 8 chil.,
- 117 4. *John*, b. Ap., 1786; a stage-proprietor; m. *Sally Chamberlin*, of Hartford. 10 chil. He d. about 1838.

- 118 5. *Deodatus*, b. June 19, 1790; A.M. Union Coll., and D.D., Geneva Coll.; in 1819, ordained a minister of the Prot. Episcopal Church; was five years a missionary in Western N. York; afterwards, many years Rector of Christ Church, Ballston Spa, where he now resides. He m., in 1821, *Mary Fine*, of Green Co., N. Y. 5 sons and 1 dr.
- 119 6. *Betsy*, b. 1792; d. about 1844.
Three other chil. of John and Lydia (Woodward) Babcock, d. in infancy.
- 120 6. JOHN, b. Mar. 13, 1760; a physician, of Newark, N. J.; m. KATHERINE ROSEURANT. He d. 1785, leaving a son, *John A.*, grad. Columbia Coll., N. Y.; practised medicine about two years, then moved to New Orleans, where he soon after d. suddenly, by a fall from his horse.
-
82. 121 (V.) AARON WOODWARD, of Coventry; m., Oct. 25, 1758, ELEANOR BENTON, of Tolland, Conn. He d. in Wilbraham, Mass., May 18, 1793, and his wid. d. in 1817. Chil.,
- 122 1. DORCAS, b. Aug. 19, 1759, d. early.
- 122 2. AARON, b. Oct. 14, 1760. In 1776, he enlisted and belonged to that portion of the Connecticut division, which occupied Fort Griswold. His health was impaired by military service, and after he left the army he commenced an academical course, and graduated at Yale College, in 1789; studied divinity with Rev. Benjamin Trumbull, D.D., the historian; was ordained in Wilton, Conn., Jan. 8, 1794, and 12 days afterwards, Jan. 20, 1794, m. MARTHA TRUMBULL, a daughter of his venerable teacher. Ill health compelled him to relinquish his pastoral charge, in 1808, when he moved to Wilbraham, where he died of paralysis, Feb. 25, 1840, set. 80. His wid. d. Dec. 10, 1851, aged 88. Chil.,
- 123 1. *Martha*, b. in Wilton, May 9, 1795; m., Ap. 14, 1829, *Andrew Brewer*, of Wilbraham. One child, *Martha Elizabeth*.
- 124 2. *Julia Ann*, b. June 13, 1798; m., Dec. 30, 1816, Hon. *Charles Stearns*, of Springfield, Mass. [See [169,] p. 493.]
- 126 3. *Jerusha*, b. Sept. 18, 1800; of Wilbraham, unm.
- 126 4. *Elizabeth*, b. in Wilbraham, Ap. 27, 1804; d. Jan. 12, 1837.
- 127 5. *Angelina*, b. Oct. 2, 1809; of Wilbraham, unm.
- 128 3. ELEANOR, m. — SEARLE, of Tolland, Conn.; now resides in Gouverneur, N. Y., with her son-in-law, Dea. Enos Pright.
- 129 4. EUNICE, m. Dr. CONVERSE CUTLER, of Tolland, and d. in Hardwick, Mass., in May, 1821.
- 130 5. ELISHA, a merchant and captain; m. LYDIA YOUNG, of Wilbraham; d. in 1800, leaving one son *Nelson*, now a merchant, near N. York city.
- 132 6. ROSEWELL; of Lockport, N. Y.; numerous children.
- 133 7. DORCAS, b. Feb., 1771; d. in Springfield, Mass., Oct. 6, 1852, unm.
- 134 8. ANNA, d. in Tolland, Mar., 1795.
- 135 9. ELECTA, m. LEVI FLINT, of Wilbraham, and d. June 29, 1805.
- 136 10. JOHN HARRIS; a teacher, in Charleston, S. C., where he d. in 1812, unm.
-
83. 137 (V.) SAMUEL LADD, (?) of Coventry, m., 1750, ANNA WOODWARD. She d. Mar. 19, 1808. Chil.,
- 138 1. NATHANIEL, b. Oct. 4, 1751; m. ABIGAIL SCRIPTURE, of Coventry, and settled in Woodstock, where he was a deacon of the Cong. Church. Chil.,
1. *Nancy*. 2. *Nathaniel*. 3. *Abigail*. 4. *Lavina*. 5. *Ephraim*. 6. *Berthena*.
7. *Mason*. 8. *Betsy*. 9. *Nancy*.
- 148 2. SAMUEL, b. July 16, 1753; m. ELIZABETH REDINGTON, of Coventry; settled first in Sharon, Vt., and thence removed to Tunbridge, Vt., where he died. Chil.,
1. *Anson*. 2. *Wealthy*. 3. *Anna*. 4. *Samuel*. 5. *Electa*. 6. *John*.
7. *Elizabeth*.
- 156 3. DORCAS, b. Oct. 9, 1756; m. JOSIAH BABCOCK, of Mansfield, Conn.; settled in Pomfret, Vt., where she d. Ap. 13, 1815. Chil.,
1. *Josiah*. 2. *Clarissa*. 3. *Lebbeus*. 4. *Russell*. 5. *Lovina*. 6. *Roxana*.
- 163 4. ASHBEL, b. Jan. 15, 1759; m. IRENE BABCOCK, of Mansfield, Conn., and settled in Sharon, Vt., where he died. Chil.,
1. *Ashbel*. 2. *Phebe*. 3. *Philenda*. 4. *Lucinda*. 5. *Ralph*. 6. *Alford*.

- 170 5. OLIVER, b. Oct. 1, 1760; m. MARY BARCOCK, of Mansfield, Conn., settled in Strafford, Vt., and d. there, Jan. 28, 1838. Chil.,
1. Polly. 2. Pamela. 3. Alpheus. 4. Clarissa. 5. Merrilla. 6. Sally.
- 177 6. ANNA, b. Nov., 1762; m. JOHN LOVEJOY, of Sharon, Vt., where she resided until after the decease of her husband. She was living in Ferrington, N. Y., in 1849. Chil.,
1. Fanny. 2. John. 3. Andrews. 4. William Ingraham.
- 182 7. FREDERICK, b. Oct. 9, 1765; m. FANNY HODGES, of Monson, Mass. He settled first in Sharon, Vt., and thence removed to Norwich, Vt., where he died. Chil.,
1. Frederick. 2. Charlotte. 3. Roxana. 4. Alfred. 5. Orrin.
- 188 8. PHEBE, b. June 15, 1767; m., May 17, 1793, ROSWELL PRIOR, of East Windsor, Conn. She d. Mar. 18, 1840, in Coventry, where all of her children now reside. Chil.,
1. Harry, b. Feb. 5, 1797. 2. Harriet, b. Dec. 20, 1798.
- 189 3. Electa, b. Jan. 29, 1805. 4. Prosper, b. June 19, 1807; m., Dec. 3, 1834, Calista Loomis. 3 chil.
- 191 9. ROGER, b. May 7, 1770; m. MARY PRIOR, of East Windsor, settled in Strafford, Vt., where he d. July 2, 1832. Chil.,
1. Henrietta. 2. Eliza. 3. Maria. 4. Sarah. 5. Laura.
-
92. 198 (VII.) MINER COBB, of Coventry, Conn., m., in 1800, ESTHER HUNT. She d. Sept. 14, 1851. Chil.,
- 199 1. EDWIN, b. July 28, 1801; m. FANNY HANFORD, 6 chil.
- 200 2. OLIVIA SHEPHERD, b. May 6, —; m. RALPH H. SPENCER. 4 chil.
- 201 3. SANFORD HUNT, d. young.
- 201 4. FANNY ROSE, b. June 8, —; m. NATHAN AVERY, of Alleghany Co., N. Y.
- 202 5. CLARISSA HUNT, b. Ap. 26, —; m. GEORGE BENNETT, a farmer, of Western N. York.
- 203 6. NELSON, b. Mar. 19, —; a lawyer, of Franklinville, N. Y.
- 204 7. JULIETTE, b. Aug. 6, 1814; m. SIDNEY THOMAS, now of Wellsville, Alleghany Co., N. Y.
-
93. 205 (VII.) GAD HUNT, Jr., of Coventry, m., Mar. 26, 1802, MARY BISSELL. He d. Mar. 12, 1835. Chil.,
- 206 1. MARY BISSELL, b. Mar. 28, 1803; m., Ap. 18, 1831, LYMAN HYDE, a mechanic, of Ellensville, Ulster Co., N. Y. Chil.,
1. Lucius B. 2. Sarah E. 3. Sanford M. 4. Mary A.
- 207 2. CLARISSA HARLOWE, b. Jan. 3, 1805; m., Feb. 27, 1827, AUGUSTUS CLARK, a farmer, of Coventry. Chil.,
1. Lucy Ann, b. Aug. 11, 1828; m., Oct. 31, 1849, William Tibals.
2. Mary E., b. July 15, 1830. 3. James A., b. Aug. 13, 1835.
4. George Hunt, b. July 11, 1844.
- 208 3. SANFORD MYRTELLO, b. Nov. 24, 1807; a merchant, of Boston; m. (1st), Aug. 1, 1832, SARAH A. J. FULLER. He m. (2d), May 22, 1848, FANNY R. HUNT. [217.]
1. Sanford Myrtello, b. May 7, 1833; d. Aug. 31, 1834.
2. Sanford Myrtello, b. Sept. 30, 1834. 3. Wm. Fuller, b. May 24, 1837.
4. Waller Lester, b. Nov. 2, 1841. 5. Emma S., b. June 7, 1843; d. Ap. 7, '44.
6. Albert B., b. May 31, 1849. 7. Sarah F., b. Sept. 24, 1850.
8. Henry L., b. Sept. 24, 1852.
- 209 4. LUCIUS ABBOTT, b. July 3, 1813; of Rockville, Conn.; m., Ap. 19, 1841, SUSAN HARRIS. Chil.,
1. Emeline F., b. Jan. 20, 1842. 2. Harriet E., b. Aug. 29, 1843.
3. Charles E., b. July 10, 1847. 4. Frederick T., b. Dec. 18, 1849.
5. William Henry, b. Ap. 25, 1853.
-
94. 210 (VII.) SANFORD HUNT, of Coventry, m., Dec. 25, 1799, FANNY ROSE, of C. He was a merchant through the middle of life, and he d. at Hunt's Hollow, N. Y., June 7, 1849. Chil.,
- 211 1. SAMUEL ROSE, b. Sept. 22, 1800; a farmer, of Hunt's Hollow.
- 212 2. JOHN HALE, b. Mar. 17, 1804; formerly a printer; in 1846, a member of the

- State Convention, for revising the State Constitution; now (1853) a Deputy-Collector, of the port of N. York, where he resides. He m., June 9, 1835, ANN DORAN. 4 chil.
- 213 3. ELIZABETH, b. Ap. 16, 1806; m., Feb. 26, 1826, GREENLEAF CLARK, a farmer, of Portage, Livingston Co., N. Y. She d. Sept. 27, 1851. 9 chil.; 7 are d.
- 214 4. MARY, b. Oct. 6, 1809; m., Ap. 29, 1832, CHARLES WILLIAMS, a farmer, of Portage, Livingston Co., N. Y. She d. Oct. 18, 1835.
1. *Washington Hunt*, b. Feb. 15, 1833. 2. *Elizabeth*, b. June 30, 1834, d. 1846.
- 215 5. WASHINGTON, b. Aug. 5, 1811; a lawyer, of Lockport, N. Y.; Rep. of the 34th Cong. District, in the State of N. York, in the 28th, 29th, and 30th Congress; afterwards Comptroller of that State, and more recently Governor thereof. He m., Nov. 20, 1834, MARY H. WALBRIDGE; one child.
1. *Robert Henry*, b. Oct. 9, 1848.
- 216 6. HORACE, b. Oct. 7, 1813; a merchant, of Portage, N. Y., and Rep. in the State Legislature. He m., Sept., 1838, BETSEY R. PARMELEE. Chil.,
1. *Jason Douglass*. 2. *Edward Lansing*. 3. *Fanny Rose*.
4. *Horace Hale*. 5. *Sanford*.
- 217 7. FANNY ROSE, b. Sept. 5, 1817; m., May 22, 1848, SANFORD M. HUNT, her cousin. [208.]
- 218 8. SANFORD, b. May 22, 1820; a merchant, of Holland, Erie Co., N. Y. He m., Dec. 31, 1846, MARILLA L. CURRIER. He d. Jan. 4, 1849, leaving one child.
1. *Mary Rose*, b. June 28, 1848.
- 219 9. EDWARD BISSELL, b. June 15, 1822; grad. at Mil. Acad., West Point, 1845; is a Lieut. in the U. S. Corps of Engineers, and now (1853) engaged in the U. S. Coast Survey. He m. HELEN M. FREE.
103. 220 (VII.) HORACE HUNT, bred a merchant; now (1853), agent of the Am. Bible Society; residing at Thompson, Conn. He m. (1st), BETSEY SALMON. He m. (2d), SUSAN BARBER. Chil.,
- 221 1. RICHARD SALMON, b. Dec. 24, 1812; a lawyer, of Bonham, Fannin Co., Texas; m., 1844, AURELIA LOW.
- 222 2. WILLIAM HUDSON, b. at Cairo, N. Y., May 1, 1814; went to Texas in 1836, where he m., in 1845; for some years civil engineer of the Government; now (1853) a land agent, locating and settling lands. 4 chil.
- 223 3. HORACE B., b. at Manlius, Onondaga Co., N. Y., Aug., 1815; grad. Un. Coll. 1841; studied Theology at Princeton and Lane Theol. Seminaries; in 1843 was licensed to preach, and d. Sept. 29, 1844.
- 224 4. ELIZABETH, b. at Manlius, Mar. 4, 1818, d. at Hunt's Hollow, Jan. 13, 1840.
- 225 5. SARAH SALMON, b. at Oriskany, Oneida Co., N. Y., Ap. 12, 182-, d. Dec. 3, 1827.
- 226 6. LANSING, b. at Oriskany, Oct. 27, 182-, d. Mar. 1842.
- 227 7. SANFORD BEEBE, b. at Ithaca, N. Y., Dec. 25, 1827; grad. Willoughby Coll.; is new (1853) Demonstrator of Anatomy in the Mill. Coll. at Buffalo, and editor of Med. Journal at the same place. He m. in 1848, S. JANE STEPHENS.
- p. 658. [14.] It is probable that John Woodward m. wid. Abigail Stubbs in the summer of 1658, as wid. Abigail Stubbs had land in Charlestown assigned to her in Mar., 1658, and that Rose was her eldest child.
- [17.] The Will of Daniel Woodward, of Sud., dated Ap. 11, 1766, mentions wife Prudence; son-in-law Israel Moore [who m. Susanna], ex'r; son-in-law, Nathan Loring; gr. son Daniel Loring, and gr. drs. Sarah and Kezia Loring.
- [18.] Rebecca, wife of John Woodward, d. 1696. He m. (2d), Sarah Goodenow, who d. Sept. 22, 1723. He d. Nov. 3, 1732, aged 83. Inventory, £133 9s. 7d. He had a dr. Susanna, who d. Sept. 22, 1676. [See Jackson, p. 464.]
- p. 660. [36.] Mary Woodward, m. Feb. 26, 1735, James Richards, of Newton. She d. July 23, 1738. 2 chil., both d. young.
- [37.] Jonas Woodward m., 1734, Mary Cook, of Needham.
- [38.] Strike out the 2d m. of Daniel Woodward. His wife Mary d. 1776, aged 57. He d. 1774, aged 60.
- [45.] Samuel Woodward was in the battle of Concord, and on Dorchester Heights.
- [64.] Jonathan W., by 1st wife, had Margaret, b. Jan. 14, 1715, and by 2d wife, Hannah, b. May 6, 1726.
- [66.] JONATHAN WOODWARD, JR., had 3. *Jonathan*, b. Jan. 27, 1747. 4. *Jonas*, b. Dec. 12, 1748, d. young. 5. *Mary*. 6. *Ann*. 7. *Amos*, b. Sept. 5, 1755. 8. *Huldah*, b. Sept.

27, 1757. 9. *Seth*, b. Dec. 2, 1759. Wife Mary d. 1764, aged 43, and he m. (2d), 1765, *PATIENCE DAMON*.

[73.] Ebenezer Woodward m. (2d), Margaret, wid. of Nathaniel Hammond, Jr., and a sister of his first wife. [See [72.] p. 781.]

[74.] Mindwell m., 1736, Nathaniel Shepard.

[75.] For Ebenezer, read Elenor, who m. — Jones.

[77.] Lydia, m. — Bacon. [78.] Achsah, m., 1775, Wm. Murdock.

[78.] Lucy, b. Jan. 20, 1755, d. in 1820, unm.

[79.] Ebenezer Woodward and Catherine Fuller, m., in Weston, May 24, 1781.

- p.661.1 [99.] (VII.) WILLIAM WOODWARD, b. July 14, 1752; m., Dec. 10, 1772, ELIZABETH MAYNARD. The mother and two chil. d. in Connecticut, after which he moved to Lancaster Co., Penn., where he m., Mar. 22, 1791, ELIZABETH SNODGRASS, where he had two children. He moved thence to Mason Co., Ky., where he d., Feb. 13, 1807, and was buried at what was then known as Woodward's Crossroads, now Brookville, Ky. It is probable that Elizabeth Snodgrass was his 3d wife. [See p. 661.]
- 2 1. JOEL, b. in Conn.; went to Kentucky in 1795 with his father; m. MARY DEBOSA. 10 chil., all d., except one daughter, and all male descendants, except one grandson, Albert, Jr., son of his youngest son Albert [15].
2. ZILPAH, d. in infancy. 3. ELIZABETH, d. in infancy.
(By 2d wife, Elizabeth Snodgrass.)
- 3 4. ENOS, b. Ap. 4, 1792; m. in Mason Co., Ky., Oct. 11, 1810, SARAH MURPHY, b. in Frederic Co., Md., Aug. 19, 1791. He resided at "Woodward's Crossroads" until about 1825, when he moved to Washington, Ky. In 1831, he moved thence to Steubenville, O., and thence to Pittsburg, in 1835. His wife Sarah d. in Pittsburg, June 6, 1841, and was buried in the Methodist Protestant graveyard. He m. (2d), in Wheeling, Va., Dec. 28, 1842, Mrs. REBECCA GRIFFITH. In the spring of 1845, he accepted the Rectorship of the St. Andrew's and the St. Mary's Protestant Episcopal Churches in Chester Co., Penn., where he d., of apoplexy, Aug. 13, 1850, after a laborious and faithful ministry of 25 years. Chil.,
1. *Thomas Caldwell*, b. Oct. 21, 1811, d. Aug. 5, 1814.
- 4 2. *Maria*, b. Feb. 16, 1814; m., Jan. 3, 1833, *William Duane Wilson*, of Steubenville, O., d., in Pittsburg, Ap. 17, 1834.
- 5 3. *William Holdman*, b. Nov. 5, 1816; a merchant, of Philadelphia.
- 6 4. *Harriet*, b. Mar. 30, 1819; m., in Pittsburg, Penn., Sept. 21, 1837, *Rev. William Willey Arnett*, b. in Monongahela Co., Va., Ap. 14, 1815, now (1853) Rector of St. Paul's Church, in Milwaukie. Chil., 1. *Waitman D.*
2. *William D.*, d. 3. *Kate*. 4. *James Woodward*. 5. *Harriet*.
- 7 5. *Minerva*, b. Dec. 31, 1821; m., May 4, 1842, *William P. Young*, a merchant, then of Pittsburg, now (1853), of Milwaukie.
- 8 6. *James Armstrong*, b. Sept. 17, 1824, a Protestant Episcopal Clergyman, and a missionary, at La Fayette, Oregon.
- 9 7. *Mary Jane*, b. Feb. 14, 1827; m., Dec. 31, 1849, *Henry D. Torry*, then of Washington, Penn., now (1853) of Philadelphia.
- 10 8. *Ann Elizabeth*, b. in Washington, Ky., Aug. 25, 1829; m., in Wilkesbarre, Penn., Nov. 6, 1852, *Franklin H. Leavenworth*, of Scranton, Penn.
- 11 9. *Enos S. S.*, b. in Steubenville, O., June 1, 1833; now (1853), a merchant's clerk, in Philadelphia.
(By 2d wife, Rebecca Griffith.)
- 12 10. *Joseph R.*, b. in Chester Co., Penn., Mar. 21, 1847.
- 13 5. SILAS, b. in Mason Co., Ky., Jan. 20, 1794; of Brookville, Ky.; m., in 1814, JANE MURPHY. He d. Nov. 7, 1828. Chil.,
- 14 1. *Elvira*, b. July 3, 1815; m., Feb. 28, 1843, *Rev. B. Weed*, a Methodist Epis. Clergyman, of Pemberton, N. J. Chil.,
1. *Woodward B.* 2. *Ella W.* 3. *Joseph*.
- 15 2. *Eliza Ann*, b. July 23, 1819; m., Aug. 9, 1850, *Albert Woodward*, a merchant, of Brookville, Ky., her cousin [2].
1. *Albert G.*, b. 1848.
- 16 3. *Amanda*, b. July 16, 1823; m., Mar. 18, 1846, *Noak Bradford*; both d. leaving one child, Silas W.
- 17 4. *Emily*, b. May 11, 1825; m. *Goron P. Freeze*, of Brookville.
1. *Jenny*. 2. *Ellen*.

[102.] Asahel, settled in Mason Co., Ky. 3 sons and 3 daughters.

- p. 667. [9.] HENRY, b. Mar. 18, 1680; of Lebanon. [Strike out all after Lebanon, and insert the following] m., Nov. 17, 1703, HANNAH BARROWS. Chil.,
1. Samuel, b. Sept. 10, 1705.
 2. Israel, b. May 20, 1708; m., Jan. 24, 1723-4, Mary Sims. [For his chil., see 17, 18, &c. p. 667 and 8.]
 3. Hannah, b. July 19, 1710.
 4. Abigail, b. Sept. 21, 1712.
 5. Sarah, b. Oct. 25, 1715.
 6. Martha, b. Nov. 14, 1717.
 7. Henry, b. Dec. 22, 1720.
 8. Anne, b. Dec. 13, 1721.
 9. David, b. May 20, 1725.
 10. John, b. Dec. 6, 1727.
- [10.] THOMAS, b. Mar. 2, 1682; of Lebanon; m., Mar. 20, 1712, HANNAH LOOMIS. Chil.,
1. Hannah, b. Mar. 5, 1712-13.
 2. Lydia, b. Oct. 11, 1717.
 3. Rachel, b. Mar. 27, 1720.
 4. Thomas, b. Aug. 11, 1723.
 5. Israel, b. July 8, 1728.
- [14.] CAPT. ISRAEL WOODWARD, of Lebanon, son of Esq. John and Experience (Baldwin) Woodward, m., Mar. 31, 1731, ABIGAIL BEARD, of BAYARD. Chil.,
1. Nathan.
 2. Anna.
 3. Abel.
 4. Abigail.
 5. Israel.
 6. John.
 7. Asa.
 8. Eunice.
 9. Elijah.
 10. Samuel, a physician, of Torrington, Conn. Chil.,
 1. Samuel Bayard, M.D., the late distinguished superintendent of the Mass. Insane Hospital.
 2. Henry, a physician, late of Middletown, Conn.
 3. William, a physician, now of Middletown.
- p. 668. [25.] WILLIAM H., b. Sept. 17, 1774.
- [36.] BEZALEEL WOODWARD, Jr., m. LYDIA FARRAR, b. May 25, 1782, dr. of Humphrey and Lucy (Farrar) Farrar. She d. 1845. [See "The Farrar Family," App., p. 12.]

WOOLCOCKS.—William Woolcocks [Wilcox], adm. freeman, May 25, 1686; proprietor of homestall in Wat., 1642; member of Art. Co. 1638; d. in Cambridge, Nov. 28, 1653.

-
- p. 668. **WOOLCOT.**—See a notice of John Woolcot, in Hist. of Brookfield, pp. 37, 38. In 4th line from bottom, for Tailor, read Tabor. Dec. 10, 1734, caution against (settlement of) Joseph Woolcot, living in house of Joseph Garfield, son of Benjamin W., from Newton, last March.

-
- p. 668. **WOOLSON.**—[1.] Thomas Woolson, Sen., was selectman 1699, 1700, 1702, 1703. It is probable that the correct orthography of this name is Wilson, and that Thomas Woolson was related to a family of Wilsons in Newton. In the church records of Weston, it is sometimes written Wilson, and likewise in Watertown records.

- p. 669. [3.] Thomas Woolson, Jr., and family, moved to Wat., 1715.
- [3-3.] CAPT. JONAS WOOLSON, of New Ipswich in 1739, one of the first five settlers therein, m., June 23, 1742, SUSANNA WILLIS, of Townsend. He d. 1790, aged 78, and his wife d. 1796, aged 70. Chil.,
1. Elizabeth, b. 1743, went to Wat., May, 1766, and caution entered; d. 1794.
 2. Susanna, b. 1745.
 3. Martha, b. 1751.
 4. Jonas, b. 1757. [See Hist. of New Ipswich, p. 444.]
- [16.] Sybil Rooper was probably a dr. of Ephraim and Sybil, of Sudbury.

WORTHYLAKE.—May 15, 1764, caution against (settlement of) Ruth Worthy-lake, from New London, Aug. or Sept. last. She m., in Wat., Dec. 10, 1767, Benjamin Prentice, q. v. Dec. 2, 1666, caution against (settlement of) Jemima Worthy-lake, from New London, Dec. 25th.

WRIGHT.—In 1720, there was a legal suit *vs.* Benjamin Wright, of Wat., clothier. May 16, 1732, caution against (settlement of) Mary Wright, from Wethersfield.

WYBORNE.—(Wybone.) June 21, 1703, Benjamin Flagg, of Wat., sold to John Wyborne, a saddler, of Dartmouth, Bristol Co., 60 A. of land in Wat. (? mortgage.) The next day (June 22), Wyborne conveyed it back again. Ap. 21, 1704, John Wybone, for £170, sold to Benjamin Flagg 60 acres.

WYER.—Dec. 18, 1748, caution against (settlement of) James Wyer, wife Sarah, and 2 chil., Lydia and Samuel, from Dracut, Oct. 20. See [19], p. 821.

- p. 670. **WYMAN.**—[17.] For [Smith (?) 52 or 94], read [Smith, 94.] Chil. of Jabez and MARY (Smith) WYMAN:
1. *Thaddeus*, b. Sept. 18, 1731; a butcher, of Charlestown.
 2. *John*, b. Aug. 22, 1733; of Camb.
 3. *Jabez*, bap. in Burlington, Dec. 26, 1736; m., in Camb., Jan. 13, 1767, *Lydia Winship*. He was slain in Concord Fight, Ap. 19, 1775.
 4. *Molly*, b. Ap. 23, 1736; m., Jan. 3, 1765, *Joshua Converse*.
 5. *Abigail*, b. Dec. 29, 1741. 6. *Charles*, (?) b. 1742, of Boston.
 7. *Martha*, b. Feb. 8, 1744.
- p. 670. [18.] A sister of Phineas Wyman was wife of Uriah Clarke [?] 33].
- p. 672. For Quincy Mary, &c., read, at Quincy, Mary, &c.

YOUNG.—For Nov. 23, read 30, and for, a dr., bap. &c., read, Daniel, bap. Sept. 11, 1748.

CORRECTIONS.

- p. 679. In 1742, William Beath lived on the south side of Belmont St., where John Hoar soon afterwards resided.
- p. 683. [115.] For Roman, read Boman [Bowman].
- p. 686. [14th line from bottom, for Lane, read line.]
- p. 727. [p. 122 [54.]] For 1633-4, read 1634-5.
- p. 730. [285 and 286.] For Gennett, read Gannett.
- p. 733. Buttery. Strike out all after inhabitant.
Ap. 11, 1637, RICHARD CARVER, of Scratby, Co. Norfolk, husbandman, aged 60, wife GRACE, aged 40; drs. *Elizabeth* and *Susanna* (twins), aged 18; also, 3 servants, viz., Isaac Hart, aged 22; Thomas Flege, aged 21; Marable Underwood, maid-servant, aged 20, were examined, in order to embark "for New England, to inhabit and remain." [Mass. Hist. Coll., 4th Ser. I., p. 97.]
- p. 734. [31.] Strike out all after Mercy Fuller
- p. 752. [15.] This Jonathan Danforth was a son of Gov. Thomas Danforth.
- p. 754. Eaton, 3d line, for 1638, read 1658. p. 755, [3.] For 1670, read 1679.
- p. 762. Flagg. See Richard Carver, above.
- p. 765. Thomas Fox, of Concord, and Thomas, of Camb. and of Wat., were not identical. That Hannah Brooks was a niece of Capt. Thomas Brooks.
- p. 770. [144.] For Martha (Whitman), read, Martha (Whitney). [See [56.], p. 965].
- p. 773. Godfrey, 2d line, for John Merrian, read, J. Sanborn. Strike out [? Marion, or Merriam.]
- p. 774. In last paragraph, for [Fort Independence] insert [a floating battery].
- p. 788. Hart. See Richard Carver, above.
- p. 793. Hayward. Henry Aldridge left two sons, Thomas and Samuel. His wid. Mary m. (2d), Samuel Judeon [his 2d wife], whose Will is dated June 7, 1657. She m. (3d), John Hayward. Healy. It was Nathaniel Healy, Jr., who was slain 1706.
- p. 797. [21.] This m., in the record, is Joseph Blanchard, of Dunstable, to Rebecca Hobart, and, Sept. 26, 1728, Joseph Blanchard, of Dunstable, m. Rebecca Hubbard.
- p. 799. Ingram. For [see page 14], read, [see Page, [14]].
- p. 850. [890.] For Mary Stearns, read, Sarah. p. 873, 31st line, for France's, read Francis's.
- p. 874. Wid. Mary Hayward. See Hayward, above.
- p. 919. 2d paragraph, 1st line, strike out, him.

APPENDIX I.

THE EARLY HISTORY OF WATERTOWN, MASSACHUSETTS; INCLUDING WALTHAM AND WESTON.

THE PLANTING OF WATERTOWN.

§ 1. In March, 1628, the Plymouth Company sold to a company of six gentlemen, in England, the territory extending from a line three miles north of Merrimack River, to one three miles south of Charles River, and from the Atlantic to the Pacific Ocean. These grantees* soon afterwards conveyed to other gentlemen an interest in their purchase, and the number of joint proprietors soon became much enlarged. They assumed the title of "The Massachusetts Bay Company," and in a few days chose Matthew Cradock, a wealthy merchant of London, Governor, and Thomas Goffe, also a merchant of London, Deputy-Governor. A charter for their Company was not obtained from Charles I. until the next year, March 4, 1628-9; but in June, 1628, three months after making the purchase, a company of emigrants was sent over, who landed at Salem, and commenced the settlement of that ancient town.

§ 2. Captain John Endicott, one of the original purchasers of the Plymouth Company, was appointed Governor of this little colony; but it is to be observed that he was not made Governor of the Company, as the Governor and government thereof then remained in England, and gave him his instructions. Mr. Roger Conant, with three others, had fixed their abode at Salem previously to the arrival of Endicott and his company; but as Conant was not sent there by the Massachusetts Bay Com-

* These original grantees were Sir Henry Rosewell, Sir John Young, *Thomas Southcott, John Humfrey, John Endicott,* and Simon Whetcombe.

The patentees, to whom the charter of the colony of Massachusetts Bay was granted, were Sir Henry Rosewell, Sir John Young, *Sir Richard Saltonstall, Thomas Southcott, John Humfrey, John Endicott,* Simon Whetcombe, *Isaac Johnson, Samuel Aldersey, John Ven, Matthew Cradock, George Harwood, Increase Nowell, Richard Pery, Richard Bellingham, Nathaniel Wright, Samuel Vassall, Theophilus Eaton,* Thomas Goffe, Thomas Adams, *John Browne, Samuel Browne, Thomas Hutchins, William Vassall, William Pinchion,* and George Foxcrofte.

The names of those who came to Massachusetts Bay are printed in italics. Mr. John Winthrop was neither an original grantee nor a patentee; and the first time his name appears in the records of the Company was September 19th, 1629, after it had been determined to transfer the government and patent to the colony.

pany, his plantation there, with his very few companions, has not been allowed to give date to the town.

§ 3. In July, 1629, Governor Cradock proposed to the Company to transfer the government of the plantation from England to the colony—"to those that shall inhabit there." A meeting of the Company was called together, August 28th, to discuss the question about such a removal. On the same day it was ordered that one committee be appointed to prepare arguments in favor of a removal, at the head of which was placed Sir Richard Saltonstall; and another committee to prepare arguments against it. On the next day, August 29th, after long debate, it was determined by a vote to be "the consent of the Company," that "the Government patent should be settled in New England." At a "Court" (meeting of the Company), on the 19th of October, it was determined that a Governor and assistants should be chosen for New England, and the next day, Mr. John Winthrop was chosen Governor, and Mr. John Humfrey, Deputy-Governor. At the last court of the Company held in England, March 23, 1629-30, on board the *Arbella*, Mr. Thomas Dudley was elected Deputy-Governor in place of Mr. Humfrey, who had concluded not to go to New England at that time.

§ 4. After determining to remove the government of the Company to the colony, and electing a Governor and assistants with that view, active preparations were made for a large emigration the ensuing year. Seventeen emigrant ships left England in the year 1630, of which fourteen sailed before the first of June. The first ship, the *Lyon*, sailed in February, and arrived in Salem in May, where the passengers probably remained, awaiting the arrival of their expected companions, with the Governor and assistants. The next ship, the *Mary and John*, carrying the Dorchester company, who first planted Dorchester, sailed from Plymouth on the 20th of March, and arrived at Nantasket, Sunday, May 30th, fourteen days before the arrival of the Governor. On the 8th of April, four ships, the *Arbella*, the *Jewell*, the *Ambrose*, and the *Talbot*, sailed from the Isle of Wight, bringing the Governor, Deputy-Governor, several, if not all, of the assistants, Rev. George Phillips, Rev. John Wilson, and others, who afterwards held prominent places in the early history of the colony. The *Arbella* arrived at Salem, June 12th, the *Jewell*, June 13th, the *Ambrose*, June 18th, and the *Talbot*, July 2d.

§ 5. The passengers who arrived in these ships were not satisfied with Salem, as possessing the desirable advantages for a permanent settlement, and soon after landing, Governor Winthrop and Sir R. Saltonstall, with others, went, on the 17th of June, to reconnoitre the country about the Bay, for the purpose of selecting a place for settlement. Having selected the peninsula of Charlestown for that purpose, they returned to Salem, and, as soon and as fast as preparations could be made for their accommodation, the passengers of the fleet proceeded from Salem to Charlestown.

§ 6. In the *Arbella* came over the families of Sir R. Saltonstall, Rev. George Phillips, and probably not less than a dozen other families, who were among the first settlers of Watertown. In the addenda to Winthrop's Journal, Vol. II. p. 340, is the copy of a catalogue of names, in the handwriting of Governor Winthrop, which the editor, Mr. Savage, supposed to be a list of persons designing to come over, and that the first list contained the intended passengers for one of the ships. This must have been the *Arbella*, as on that list are the names of Mr. Winthrop, Sir Richard, and others, who are known to have come in this ship. On that list are also the names of fifteen very early Watertown families.

§ 7. Soon after the removal of the emigrants from Salem to Charlestown, a large portion of them, with Sir Richard Saltonstall as their leader, accompanied by Rev. George Phillips as their pastor, proceeded about four miles up Charles River and commenced a settlement, at first sometimes called Sir Richard Saltonstall's plantation, but soon after, by the Court, named Watertown. It is difficult to determine the date of the removal from Salem to Charlestown, as it was probably a gradual

process; nor is the exact date known, when Sir Richard and his followers left the latter place for Watertown. But their stay in Charlestown must have been short; for only forty-eight days elapsed after the landing of Sir Richard at Salem, before Watertown affairs had become sufficiently matured to organize a church, when forty men, with Sir Richard at the head, signed the covenant.

§ 8. It seems clear that only three towns in the colony can claim priority of settlement over Watertown. The *first*, or oldest, is Salem, settled in 1628. The *second* is Charlestown, which was first settled by a feeble colony of about a dozen men, sent thither from Salem about the last of June, 1629, by Governor Endicott, by order of the Company, in order to forestall Mr. Oldham in taking possession of that part of the Bay, which his patent covered. The *third* was Dorchester, which was planted by the Dorchester men, who arrived at Nantasket in the Mary and John, May 30, 1630. The *fourth* town was Watertown, begun by Sir Richard Saltonstall probably before the middle of July. On the day of the landing of the passengers of the Mary and John at Nantasket (Sunday, May 30th), ten of their number, embracing some of their chief personages, obtained a boat and proceeded first to Charlestown, and thence up Charles River about five miles, and landed at a place in Watertown, long afterwards known as "Dorchester Field," on or near which is now built the U. S. Arsenal. As they landed in planting time, it is supposed that they planted crops, which they returned to gather, and hence the name, Dorchester Field. They had, however, staid there "not many days," when they were required to join their companions, who had in the meantime moved from Nantasket to Matapan, soon after named Dorchester. If this short residence and planting, by the Dorchester men, were deemed a settlement, Watertown might claim priority over Dorchester; but it has never been so considered.

§ 9. That a large number of settlers accompanied Sir Richard to Watertown, or very soon followed him, is evident from the following considerations: In the first place, "about forty men" signed the covenant on the 30th of July. It is known that some of them, probably most of them, had families. The number of female members is not stated. There is good reason to believe that others, some of them having large families, did not then sign the covenant, not being entitled to church membership. In the next place, on the 30th of November, only four months later, the Court of Assistants passed an order to collect of the several plantations, except Salem and Dorchester, £60, for the maintenance of the two ministers; and the portion of the several towns was as follows: Boston, £20; Watertown, £20; Charlestown, £10; Roxbury, £6; Medford, £3; Winnesmet, £1. When it is considered that, at this time, most of the office-holders and men of large estates, except Sir Richard, belonged to Boston and Charlestown, and that assessments were made according to estates or possessions, it is not unreasonable to suppose that the population of Watertown was then equal to that of Boston and Charlestown. It is also to be observed that one-half of that whole assessment was assigned to Mr. Phillips, the minister of Watertown.

§ 10. Until the end of the first year (1630), all the plantations and people in the colony, excepting Salem and Dorchester, appear to have been regarded as two churches or congregations, with their two pastors, between whom the assessment for pastoral maintenance was to be equally divided. One of them was the church organized in Charlestown, embracing Boston, and probably the few people of Roxbury, Medford, and Winnesmet. Here Governor Winthrop engaged to provide accommodation for the minister, Mr. Wilson. The other church was that organized in Watertown, where Sir Richard engaged to provide for the minister, Mr. Phillips.

THE ORGANIZATION AND AGE OF THE CHURCH.

§ 11. There is a question respecting dates, in which Watertown is interested, that has engaged the earnest attention of several inquirers. It relates to the chronology of the very early churches of Massachusetts Bay, and writers have differed in their conclusions. Dr. Holmes [Mass. Hist. Coll., 1st ser. vii., p. 15] places them in the following order of dates: 1, Salem; 2, Charlestown; 3, Dorchester; 4, Roxbury; 5, Lynn; 6, Watertown. Captain Edward Johnson makes Boston church (organized in Charlestown) the fourth, and Watertown the seventh church. Rev. Samuel Sewall [Am. Quar. Reg. xi., p. 48] considers Charlestown the third church, yet he afterwards presents reasons for considering the churches organized at Charlestown and Watertown coeval. Dr. Kendall, after a lucid collation of historical authorities, says, "If there be no mistake in the historical facts now adduced, it would seem that Watertown church had a prior existence to the one at Charlestown, and was second only to that of Salem, in Massachusetts Bay." [Centennial Discourse, p. 21.] At the end of this discourse is a very elaborate note by "A. H." (Dr. Holmes), in which he attempts to invalidate Dr. Kendall's conclusions, chiefly by arguing from the usages of the churches, but overlooking an important element in the argument.

§ 12. Salem church may, without doubt, claim the priority. The first church of Dorchester was the second, or next oldest. The people who collected together at Plymouth, England, in order to embark in the *Mary* and *John*, "because they designed to live together after they should arrive here, met together in the New Hospital in Plymouth, and associated into church fellowship, and chose Mr. Maverick and Mr. Warham to be their ministers." This was probably done in the early part of March, 1630, as the *Mary* and *John* sailed on the 20th of that month. In 1636, this church, or a large part of it, with its church organization, migrated from Dorchester to Windsor, Connecticut, and of course ceased to be a church of Massachusetts Bay. After this removal, the remnant of the church left in Dorchester, with Mr. Richard Mather and the company that came over with him, united and organized another church, their covenant being dated August 23, 1636. From that time this has been the oldest church in Dorchester; but it must concede the priority to several other churches.

§ 13. Since that migration to Windsor, Watertown has a fair claim to rank as the second church of the colony. The only one that has a plausible claim to be even coeval, is the first church of Boston, originally organized in Charlestown.

§ 14. Mather says, of the first settlers of Watertown, "they resolved that they would combine into church fellowship as their first work." Upon the recommendation of the Governor, July 30, 1630, was observed as a day of fasting and prayer by the people both of Watertown and Charlestown. This religious observance was proposed on account of the great sickness and mortality then prevailing in Charlestown; and other churches, including that of Plymouth, were requested to observe the same day in the same manner. There is no evidence that Watertown was then afflicted in the same manner. The sufferings of the people of Charlestown were attributed to the deficiency of good water, with which Watertown was abundantly supplied, and for the sake of which they are said to have selected the site for their settlement. While the Watertown people sympathized with their Christian neighbors in their afflictions, and prayed for their relief, we may suppose that they were not so much engrossed therewith as to preclude the necessary attention to what they had resolved to do "as their first work." After the close of these religious exercises in Watertown, Mather says, "About forty men, whereof the first was that excellent knight, Sir Richard Saltonstall, then subscribed this instrument, *in order unto their coalescence into a church estate;*" and he inserts the covenant, *in extenso*, "because it was one of the *first* ecclesiastical transactions of this nature managed in the colony.

But in after time, they that joined unto the church [evidently implying that he regarded it as a duly organized church from the date of that covenant] subscribed a form of covenant somewhat altered," [implying that the signing of that first covenant was entering into church fellowship]. Again, Mather says, "A church of believers being *thus gathered* at Watertown, this reverend man [Mr. Phillips] continued for divers years among them," &c., evidently considering the "ecclesiastical transaction" on the 30th of July, as "the gathering and ordering of the church," and the subsequent services of Mr. Phillips, as a continuance to fulfil the duties arising from the relation then formed.

§ 15. The writer of the elaborate note at the end of Dr. Kendall's discourse, already referred to, attempts to show from the usages of the early churches of New England, that the signing of that covenant, on the 30th of July, "was but a preparatory measure," only the first step taken towards the organization of a church, a sort of extemporaneous, unpremeditated affair. But, in the first place, the length and elaborate preparation of the covenant, and the number of men who signed it on that occasion, render this supposition improbable. In the next place, we find no reference in any work to any additional proceedings in organizing the church; and it is extremely improbable that Mather, in making his "more particular recital" of the "gathering and ordering of the church," would have said so much about a mere "preliminary measure," and made no reference to the more important consummation thereof, if any occurred. In the third place, this reasoning from the usages of other churches seems to be materially invalidated, if not entirely set aside, by a sentence in Mather, which the writer of the note has entirely overlooked; for it shows that Mr. Phillips and his people did not conform to those usages, or rather that others did not follow their example. "Mr. Phillips being better acquainted with the *true church discipline* [Congregationalism] than most of the ministers that came with him into the country, their proceedings [in Watertown] about the gathering and ordering of their church were *methodical enough*, though not made in all things a pattern for all the rest." Mr. Phillips was the first to assert and adopt Independency or Congregationalism in New England, and Hubbard says that, for some time, he "was without any to stand by him," and that, on that account, "he met with much opposition from some of the magistrates." In noticing the ordination of Mr. Knowles, as colleague of Mr. Phillips, December 9, 1640, Governor Winthrop says, "The church of Watertown [not a council of ministers] ordained Mr. Knowles, * * * differing from the practice of other churches, as also they did in their privacy, not giving notice thereof to the neighboring churches, nor to the magistrates, as the common practice was." These statements elucidate the organization of the church in Watertown, and they show what validity is to be attached to Dr. Holmes's argument from the usages of other churches. [See pp. †123 and 873.] S. V. H.

§ 16. The day of fasting and prayer in Charlestown (July 30) was observed in the midst of a great affliction, on account of which the fast was especially recommended; and it is scarcely supposable that the people were then in circumstances to attend deliberately and so promptly to their ecclesiastical interests, even if they had entertained the same notions of church discipline and order as did Mr. Phillips, Sir Richard Saltonstall, and their associates. Accordingly, at the close of the religious services on that day, only four men signed a covenant, which was brief, compared with that of Watertown. Two days afterwards, five others signed the covenant, and this number was increased by repeated accessions until the 27th of August, when, says Winthrop, "We of the congregation kept a fast and chose Mr. Wilson, our teacher, and Mr. Noel an elder, and Mr. Gager and Mr. Aspinwall, deacons." This gives clearly the date of this church, which soon afterwards became the first church of Boston. That this was, in early times, and for a long time, regarded as the date of the organization of the church, is clearly shown by the following extract from the diary of the Rev. Dr. Joseph Sewall, of Boston: "1730, August 27, I preach'd the Lecture from 2 Pet. 3, 15, 'Account that the long-suffering of our Lord is salv*.'

—N.B. It is y^e day 100 years since the first Church in y^e town was gather'd at Charlestown."

§ 17. If the foregoing observations do not amount to a demonstration, there seems to remain little or no doubt but that Watertown was the first church in New England, that distinctly adopted the Congregational order; that it may justly claim priority over the first church of Boston, and, since the migration from Dorchester to Windsor, is entitled to rank as the second church of Massachusetts Bay.

RELATIVE EARLY POPULATION AND WEALTH.

§ 18. The accompanying table, [p. 983] besides presenting the amount of taxes levied for the uses of the Colony, shows the relative estimated wealth or valuation of the very early towns for several years. It will also aid in forming an idea of their respective populations. But assessments alone will not give the numbers correctly, as taxes had respect to estates and not to the number of persons. At the first meeting of the deputies, ever held in the colony (May 4, 1634), the Court ordered that, "in all rates and public charges the towns shall have respect to levy every man according to his estate, and with consideration of all other his abilities whatsoever, and not according to the number of persons." As Watertown was neither a shire town, nor a place for much trade (not being a shipping-port, although accessible by small vessels), it did not offer to official men and capitalists such attractions for settlement, as did some other towns. After the departure of Sir Richard Saltonstall, there was no Assistant or Magistrate, resident of Watertown, until 1686; and wills and inventories show that there were in Watertown, no large estates, such as are usually accumulated by trade. The people being entirely devoted to agriculture, with a few exceptions, where a mechanical trade was carried on in the intervals of farming, property was more equally distributed than among people who could enter into commercial pursuits. For eighty years after the first settlement, there was not more than one or two inventories that exceeded £700. An inspection of the table, with these considerations in view, shows almost to a certainty, that, for the first four years, Watertown was the most populous town in the Colony, and it is not improbable that it continued so for fifteen or twenty years. In 1645, the levy on Boston was, to that of Watertown, as 100 to 41½. But Boston was then the residence of the Governor and of the principal merchants; the seat of government and the emporium of trade, and of course the focus of wealth. Johnson, in 1651, [Wond. Work. Prov.] in giving some brief statistics of the very early towns, gives no statistics of Boston, as to the number of houses, or families, or of the acres under tillage. It was "the centre town and metropolis," "the mart of the land." But he calls Watertown "this great town consisting of one hundred and sixty families;" with "almost two hundred and fifty souls in church fellowship;" with "land in tillage near upon one thousand eight hundred acres;" "their herd of kine and cattle of that kind, about four hundred and fifty, with some store of sheep and goats." His account of the other towns shows that Watertown, in most, if not in all of those particulars, outranked all the other towns, except Boston, of which, as just stated, he has given no statistics.

Notes to the preceding Table.

§ 20. The first five taxes were for specific objects; the others for general uses.

¹ In this tax, Mr. Theophilus Eaton was individually taxed £20 without giving his residence. It was a 1-75th of the tax of the whole colony. His name is on a levy of the preceding November, but not the sum given.

² The name of Wessagusset was changed to Weymouth, September 2, 1635.

³ Nantasket, or Nantasket was taxed only twice. The following order implies that the plantation was then broken up. In June, 1641, the Court ordered that a plantation be forthwith set up at Nantasket "for the furthering of fishing." The name was changed to Hull, May 2, 1644.

⁴ Wincemet was annexed to Boston, September 3, 1634, and ceased to be taxed separately.

⁵ Saugus and Marble Harbor were taxed together in 1632. "It was proved to the Court, March 3, 1635-6, that Marbleneck belongs to Salem," and it was separated from Salem and incorporated as a town, May 2, 1649. The name Saugus, was changed to Lynn, November 20, 1637.

⁶ The name New Town was changed to that of Cambridge, May 2, 1638.

⁷ A plantation was begun at Agawam as early as September, 1630, but was abandoned by order of the Court. A permanent settlement was made there in the spring of 1633, and on the 5th of August, 1634, the Court gave it the name of Ipswich.

⁸ May 6, 1635, the Court allowed Wessacumcon to be a plantation, and at the same time named it Newbury.

⁹ The name Bare Cove, was changed to Hingham, September 2, 1635.

¹⁰ The order for planting Dedham was passed by the Court, September 3, 1635, and by an order passed September 8, 1636, the plantation was named Dedham, and exempted from public charges for three years from the first of May next.

¹¹ The plantation beyond Merrimack River was named Colchester, September 4, 1639, and Salisbury, October 7, 1640.

¹² The order for making a plantation at Musketaquid, was passed September 3, 1635, and named Concord; and it was exempted from all public charges, except trainings, for three years.

¹³ March 3, 1635-6, the Court ordered a plantation to be settled at Winnacunnet; on the 22d of May, 1639, gave it the powers and privileges of a town, and the next September, 4th, gave it the name of Hampton.

¹⁴ At this Court (June, 1642), the following towns were taxed for the first time "for public uses," viz.: Braintree, £14; Rowley, £15; Sudbury, £15; Gloucester, £5.10.

¹⁵ At this Court (May, 1645), Woburn was taxed for the first time £7, and Wenham £3.10. "for public uses."

THE NAME OF THE TOWN.

§ 21. The Indian name of Watertown has been usually printed, *Pigsusset*. It is sometimes found written *Pigs go suck*. The correct orthography is probably *Pequusset*, as it is usually and very often found so written in the early town records. It is sometimes written *Peguusset*. There was a tract of land on the north border of the town, a very little distance east of Lexington Street, then called Concord Road, which is often mentioned in deeds, and in lists of possessions, called *Pequusset Meadow* or *Pequusset Common*, and for many years used as a cow-common. There was a way leading to it, sometimes called *Pequusset Road*, and likewise a *Pequusset Hill*. The extent of the meadow, which bore this name, has not been ascertained. [See Section 81.]

§ 22. There has been some question as to the origin of the present name, *Watertown*. It has been asserted or surmised, on what authority I know not, that it was named for Waterton, a village in Yorkshire, which name Sir Richard Saltonstall wished to perpetuate. This seems to be favored by the circumstance that nearly all the very early plantations in that vicinity were named for towns in England; yet very little credit is to be attached to it. We find no evidence that there ever was a place of that name in Yorkshire. A daughter of Sir Richard Saltonstall, evidently a well-educated lady, in writing to her brother Samuel, in 1644, directs it to *Watertowne*. If it had been named for a *Waterton* in England,



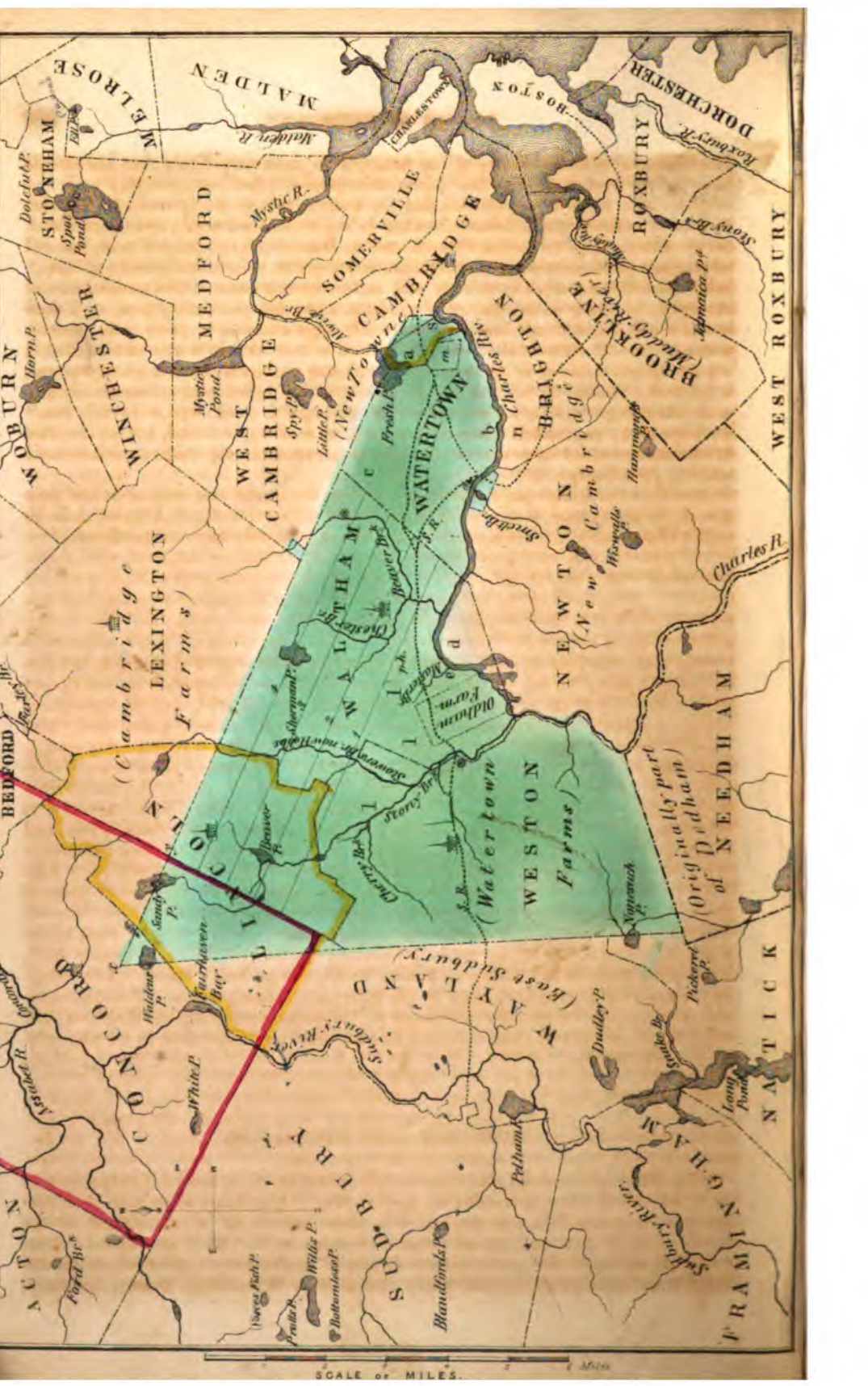

in compliance with the wishes of her father, it is extremely likely that she would have known it, and retained the correct orthography. [See Note, p. 916.]

§ 23. It is much more probable that the ancient and generally received tradition is correct—that it was so named because it was so well watered. Johnson [Wond. Work. Prov., chap. 28], calls Watertown “a fruitful plot of large extent, watered with many pleasant springs, and rivulets, running like rivers throughout her body.” After describing the inconvenience and sufferings encountered at Charlestown for the want of good water, Prince [Annals, p. 244] says of the settlers of Watertown, “some travel up into the main till they come to a place *well watered*, whither Sir R. Saltonstall, with Mr. Phillips and others went, and settled a plantation and called it *Watertown*.” Hubbard does not deem the being well watered, a sufficient reason for so naming it, “most of the other plantations being well watered, though none of them planted on so large a fresh stream as this was.” Perhaps some plantations, afterwards settled, were as well watered, but at the time Watertown received its name, no other plantation could, in this respect, be compared with it. [See Sections 120–130.]

At a Court of Assistants, September, 7, 1630, the second that was held after their arrival in the Colony, it was ordered that “the towne vpon Charles Ryver shall be called Waterton.” In the margin of this record, it is written, “Water Toune.”

MAP.

The accompanying map is intended to show the relation of Watertown to the surrounding towns; its original boundaries and extent, as determined by the Court; the overlapping of the grants made to Watertown and Concord, and the several excisions, by which Watertown became reduced to its present small dimensions. Also some of its most important localities. *S.* the homestall of Sir Richard Saltonstall, and afterwards of his son Samuel. *a.* The portion of territory taken from Watertown and annexed to Cambridge in 1754; *b.* Dorchester Field; *c.* Pequusset Meadow or Common; *d.* the portion of Newton (about six hundred acres) annexed to Waltham in 1849. Nearly all of this was included in the ancient Fuller Farm, and constituted about two-thirds of it; *e.* Mount Feake; *m.* Mount Auburn Cemetery; *l. l. l.* “*lieu of Township*” lands; *n.* Nonantum Hill. *P. H.* Prospect Hill; *s. r.* Sudbury Road; *x.* the N. W. corner of Watertown, according to the original order of Court; *y.* the corners of Watertown and Cambridge (*Lex.*) contiguous to Concord. The lines marked 1, 2, 3, 4, denote the *Squadron lines*, or the dividing lines of the four *Great Dividends*. This mark [*] denotes the sites of the three ancient mills, on Charles River at the bridge, on Beaver Brook, and on Stony Brook. The village or the centre of a town is denoted by the figure of a meeting-house. The four squadron lines on the map, appear to begin at the eastern boundary of Waltham, and they did so very nearly; but the exact line has not been ascertained in its whole extent. [See Sect. 86.]

TERRITORY AND BOUNDARIES.

§ 24. Most of the ships that came to this colony in 1630, landed their passengers at Salem, whence they proceeded to Charlestown. Other ships came with their passengers directly to Charlestown, and this place became the rendezvous of all the immigrants of that year, except those who came in the Mary and John. From Charlestown, this concourse of people dispersed to the several sites, where plantations were commenced in that year. These were Watertown, Boston, Roxbury,

Medford, Lynn, and Winesemet. Watertown is here placed first, because the first and the most numerous body of planters that left Charlestown that year went thither. At the first planting of those towns they probably had no definite limits, except where they had natural boundaries. The settlers selected inviting spots, on or near the margin of the bay, or on navigable water, which were separated from each other, either by natural boundaries or by intervening spaces, then deemed sufficiently broad to avoid future collision or encroachment. The territory of each plantation extended back into the wilderness in different directions from the Bay like radii, in some instances indefinitely, until limits were afterwards assigned to them by the General Court. Numerous towns, since that time, have been incorporated within the territory originally belonging to those few first settled towns.

§ 25. The site selected by Sir Richard Saltonstall and his companions was more remote from the Bay than either of the other plantations begun that year, and Watertown was the first of the inland towns. It was, however, upon the tide-water of Charles River, which was there navigable for only small vessels; but the settlement very soon, if not at first, extended above tide-water. As the company of planters who first went there was large, and as they were not compacted into a village or dense population, like other early plantations, they must have been scattered over a very considerable extent of territory. In many of the plantations the settlers were required to reside within half a mile or a shorter distance from the meeting-house, for the sake of mutual defence against the *Indians*. But we have not discovered any such order or compact in respect to Watertown.

§ 26. The first planters went to Watertown before any attempt was made to settle "The New Town" (Cambridge), and the territories of Watertown and Charlestown, although not yet defined or specially granted, seem at first to have been contiguous, and to have been regarded as embracing all that territory which now constitutes Cambridge, West Cambridge, and Lexington. This is evident, or at least is rendered extremely probable, by the language of both Winthrop and Johnson.

§ 27. In December, 1630, the Governor and assistants had repeated meetings, at different places, in order to select a site for a fortified town, and for the capital of the colony. At their last meeting, December 21, Governor Winthrop says, "We met again at Watertown, and there, upon view of a place a mile beneath *the town*, [*i. e.* the central point, or residence of the chief persons], all agreed it a fit place for a fortified town." The homestall of Sir Richard was situated on Charles River within that strip of territory which was taken from Watertown and annexed to Cambridge in 1754, and was about a mile from the site of Harvard College. Wood [*New England's Prospect*], whose distances are not exact, says Watertown was about half a mile westward from Newtown, and "this town" (the central or chief point of Watertown) was within half a mile of the Great Pond. Winthrop [*i. p.* 73] says, Watertown was "three miles above *the town*." Between the homestall of Sir Richard and the New Town [*Camb.*] line, there was only one small intervening lot (13 acres, belonging to Thomas Brigham), and this homestall was bounded on the north-west by a lot of Mr. Phillips, supposed to be the one upon which Sir Richard engaged (August 23, 1630) to build a house for Mr. Phillips. These lots of Sir Richard and Mr. Phillips were about three miles below the wear, half a mile south of Fresh Pond, and one mile from Newtown; and that point, or the immediate neighborhood, was undoubtedly what was meant by "*the town*."

§ 28. The Newtown line being run thus near to Sir Richard's residence, it is highly probable that a considerable number of his companions were found to have settled within the limits of Newtown. This view is corroborated by Johnson [*Wonder-Working Prov. chap. 28*], who says, "They [*the first settlers of Newtown*] chose a place situate on Charles River, *between Charlestown and Watertown*, where they erected a town, called Newtown, and now named Cambridge, being in form like a list cut off from the broadcloth of the *aforenamed towns*." We may infer from this language of Johnson, that Newtown, at first, possessed no land on the south side of

Charles River. We may infer it also from the language of an order passed by the Court of Assistants, June 5, 1632, granting 200 acres to Thomas Dudley, "on the west side of Charles River, over against [not in] the New Town." It is probable that, before the planting of Newtown, all the land between Charles River and Roxbury, and extending from Back Bay to the southwest, was considered as belonging to Boston and Watertown, with perhaps an undefined line between them. What portions of this belonged to these two towns respectively has not been ascertained, but probably chiefly to Boston. We have not discovered any evidence that any land on the south side of the river belonged to Newtown before 1634; but it is very probable.

§ 29. The population of Newtown had increased so rapidly, chiefly by the accession of Mr. Hooker and his followers in 1633, that, in May, 1634, scarcely three years from their beginning, they "complained of straitness for want of land, especially meadow," and asked leave of the Court to look out for further enlargement and removal, which was granted. At the next Court, held September 4th, they asked leave to remove to Connecticut; and the question of "the removal of Newtown" was "the main business" of this Court, "was debated divers days," and caused the adjourning of the Court [Winthrop, i. p. 140]. The first and main argument for removal was "their want of accommodation for their cattle," and their inability to "receive any more of their friends to help them." One answer to this was, that "they might be accommodated with enlargement, which other towns offered." Upon putting the question of removal to Connecticut, a majority of the deputies (15 to 10) were in favor of assenting to it, but a large majority of the assistants voted against it. Upon this disagreement in the votes of the two bodies "grew a great difference between the Governor and assistants and the deputies." But after keeping "a day of humiliation," and a sermon by Mr. Cotton, "the congregation of Newtown came and accepted of such enlargement as had formerly been offered by Boston and Watertown."

§ 30. At what time this offer was made has not been ascertained, but probably at the same time, if not before, Newtown people asked permission of the Court "to remove their habitations, or to have an addition to what they already have;" for at the same Court, May, 1634, it was ordered that "Boston shall have convenient enlargement at Mount Walliston," probably as a compensation for the land which they offered to Newtown. A committee, of which Mr. John Oldham, of Watertown, was chairman, was appointed to "set out" and to "draw a plot" of this grant at Mount Walliston. Soon afterwards (September, 1634) Winesmet was annexed to Boston. The land offered by Boston is designated as "the ground about Muddy River." Whether it embraced only what has been since known as Muddy River (Brookline), or embraced also a part or the whole of Brighton, the records do not show. The latter is not improbable. The land offered by Watertown was "the meadow on this side Watertown wear, containing about thirty acres, be the same more or less and now used by the inhabitants of Newtown." On September 25, 1634, the Court confirmed these offered lands to Newtown, with the *proviso*, "that if Mr. Hooker and the congregation now settled here shall remove hence, that then the aforesaid meadow shall return to Watertown, and the ground at Muddy River to Boston." In 1636, Mr. Hooker and his congregation moved to Hartford, and of course the proviso would take effect, and the grant of the offered lands be void. The land about Muddy River reverted to Boston, and was long afterwards incorporated and named Brookline; but Watertown did not recover her meadow.

§ 31. Watertown and Newtown, soon after the offered lands were confirmed to the latter, differed about their boundaries, and on March 4, 1634-5, the Court referred "the difference concerning all bounds of land between them" to a committee "to determine the same before the next Court of Assistants." This committee reported on the 7th of April, and their determination was such as to prevent the reversion to Watertown of the meadow, according to the aforesaid proviso, upon the migration of

Mr. Hooker and his company, which occurred the next year. The following is their report:—

“It is agreed by us, whose names are here underwritten, that the bounds between Watertown and Newtown shall stand as they are already from Charles River to the great Fresh Pond; and from the tree marked by Watertown and Newtown on the southeast side of the pond, over the pond, to a white poplar tree on the northwest side of the pond, and from that tree up into the country northwest-by-west, upon a straight line by a meridian compass; and further, that Watertown shall have one hundred rods in length above the weare, and one hundred rods beneath the weare in length, and threescore rods in breadth from the river on the south side thereof, and all the rest of the ground on that side the river to lye to Newtown.

[Signed]

“WILLIAM COLBRAN,

“JOHN JOHNSON,

“ABRAHAM PALMER.”

§ 32. The foregoing were the only definite boundaries of Watertown at that time, which was before the settlement of either Concord or Dedham. Orders for the settlement of both these towns adjoining Watertown on the northwest and southwest, were passed September 3, 1635; but the order for “setting out the bounds between Watertown and Concord, and between Watertown and Dedham” was not passed until May 2, 1638. The western limit of Watertown had previously (March 2, 1635-6) been fixed by an order that “the bounds of Watertown shall run eight miles into the country from their meeting-house, within the lines already set out” [on the north and south, in the Report of the Committee above inserted]. On the 8th of June, 1638, the Court ordered, “for the final end of all difference between Watertown, Concord, and Dedham, that Watertown eight miles shall be extended upon the line between them [Watertown] and Cambridge, *so far as Concord bounds give leave*; and that their [Watertown] bounds by the river shall run eight miles into the country in a straight line, as also the river doth for the most part run, and so to take in all the land of that [north] side of the river, which will not fall into the square five miles granted to Dedham; and that the neck on the same [north or left] side of the river near to Dedham town, shall be cast into the said square of five miles to make up the same, so as the said square is to be accounted by quantity and not by situation, because the place will not admit of it;* and that their [Watertown’s] eight miles from Watertown meeting-house shall be by a line between both the other [north and south] lines.”

§ 33. The controversy between Watertown and Concord related to conflicting claims to grants of land made by the General Court. The report of the committee already inserted, made in April, 1635, assigned to Watertown, as her northern

* In May, 1638, the General Court granted to the town of Roxbury 4000 acres of land, “because Dedham doth shorten them” (by a boundary line between Dedham and Roxbury, reported by committee and adopted at this Court). The order for this grant was repeated in May, 1640, but was not immediately carried into effect. In October, 1643, the Court appointed a committee “to lay out the land of Roxbury men,”—“if it be there to be had near Dedham and Watertown,” but “Dedham hath three weeks further time granted them to settle their bounds; and then Roxbury men” to have their four thousand acres “between Watertown, Sudbury, and Dedham.” (Col. Records and Hist. Rox., p. 69, &c.) This seems to be that tract of land, or a part of it, which was granted by Dedham to the Natick Indians, about 1650, in exchange for Deerfield; and it seems probable that, at the end of the three weeks, when Dedham had “set her bounds,” space was not left for the Roxbury people. Watertown and Dedham were contiguous, until the incorporation of Needham in 1711, only a short time before Weston was set off from Watertown and incorporated.

The Natick Indians are said to have been gathered together from dispersed and wandering life, into a civil society by the Rev. John Elliot, about 1650; their town was laid out the next year, and their settlement was recognized as a district, as early as 1652. Natick was incorporated as an English District, in 1762, and incorporated as a town in 1781. [See Bigelow’s Hist. of Natick, p. 21.]

boundary a line beginning at Fresh Pond, and running straight W. N. W. into the country indefinitely, that is, until the western boundary of Watertown should be determined. These lines continued (the N. and W. boundaries of Watertown) would meet within the present limits of Concord, near Walden Pond, including most of that Pond, half of Sandy Pond, and much the largest part of Lincoln. About six months after the northern or northeastern boundary of Watertown was thus reported and determined, but before it had been surveyed and marked, Concord was granted by the General Court, and their "six myles of land square" was so located as to overlap the land already granted to Watertown. As the land was first surveyed and settled by Concord people, they were allowed to retain it, notwithstanding the prior title of Watertown.

§ 34. It has just been stated that the General Court assigned the western limits of Watertown in March, 1636. It does not appear from the Court records, at what time the line was first surveyed; but in May, 1651, commissioners (John Sherman, in behalf of Watertown, and Walter Haynes, Edmund Rice, Edmund Goodenow, Thomas Noyes, John Grout, John Ruddocke, and Hugh Griffin, in behalf of Sudbury), being authorized to settle the division line between Watertown and Sudbury, did "consent and conclude that the line which was formerly by Mr. John Oliver drawn in that plan, and the same marks revised about three years since, in the presence of some of each of the towns aforesaid, commonly called *the old line betwixt Watertown and Sudbury*—shall forever stand and be accounted the true partition line." This line began at the south point of Concord, and was directly continuous with its southeast boundary, running ninety-six rods S. 30° 15' W., "to an angle betwixt two hills;" thence "south about half a point westerly" [S. 2° 20' W.], until it came within eighty rods of Nonesuch Pond, where "Sudbury bounds ended." By consulting the map, it will be seen that by this survey a small triangular piece of the land, originally granted to Watertown, was annexed to Sudbury.

§ 35. Two early grants of land were made to Watertown by the General Court, the second of which, was in compensation for land taken off by Concord. It is not improbable that the first grant was made with the same intention, and that the second was made because the first grant failed. On this point we are left to conjecture, and to inference not entirely clear. In November, 1637, by the Court, "Watertown is granted one thousand five hundred acres of meadow, if it be there convenient, at the new plantation [Sudbury], upon the river Concord is upon." The reason for this grant is not given in the record, but the date and the location of it render it probable that it was in compensation for the land taken off by Concord. Sudbury was soon afterwards incorporated, and this conditional grant to Watertown being within its limits, it would not be "convenient," to allow Watertown to have it. It is to be observed that Sudbury was a Watertown settlement and granted to Watertown petitioners, and this large grant might be deemed to supersede, and more than make good the lesser grant. But it is probable that it was not so viewed, and that the second grant was made in lieu of the first. We find in the town records, no mention of this first grant of one thousand five hundred acres, until after the lapse of more than seventy-five years, when the town may have lost sight of the relation between this first and a subsequent grant. A committee was appointed to search the Colonial Records, wherein were found mentioned two grants of land to Watertown, neither of which had been made good by location and survey; and on January 14th, 1722-3, the town "chose Col. [Jonas] Bond, Nathaniel Bright, and William Shattuck, to address the General Court, to obtain two thousand acres of upland, and one thousand five hundred acres of meadow, formerly granted to Watertown and not yet taken up, and to see whether it should be divided between Watertown and Weston."

§ 36. This is, we think, the only reference in the records to those one thousand five hundred acres of meadow, subsequent to the following second grant. In May, 1651, at the same time that the boundary between Watertown and Sudbury was

finally settled, the General Court ordered, "that Watertown shall have two thousand acres of land laid out near Assabet River, adjoining to the bounds of Sudbury, *in respect of such land as was wanting to them*, which was granted to them *formerly by this Court to be the bounds of their town*, and that Capt. Willard and Lieut. Goodenow are appointed to see this done and performed, and to make return thereof to this Court at their next session, provided it be not prejudicial to any former grants." This committee did not perform this service, probably on account of the terms of the proviso. The reason for this grant is more distinctly shown in the town records. At a town meeting, held March 12th, 1660-1, "Capt. Mason, Lieut. Beers, and Serj. Wincoll were appointed to find out where to have laid out the two thousand acres *granted by the General Court in recompense of some land taken off by Concord.*" The "bounds of the town," referred to in the preceding order of the Court, was undoubtedly the line before referred to, beginning at Fresh Pond and running W. N. W. straight into the country. Committees were appointed by the town very numerous times, in order to obtain of the Court the location and survey of this grant, but without success, until after the lapse of more than one hundred years. After this great delay, exceeding in duration unending chancery suits, the grant was located "at Wachusett Hill," and divided between Watertown, Waltham, and Weston. Waltham and Weston sold their shares in 1756, each for £267.6.8=£2005. O. T. Watertown sold her share of it about the same time.

§ 37. Within the boundaries of Watertown, as determined by the Court in April, 1635, were embraced the present towns of Watertown, Waltham, Weston, the largest part of Lincoln, and that part of Cambridge lying east of Mount Auburn Cemetery, between Fresh Pond and Charles River. Watertown is now one of the smallest townships in the State, and it has been reduced to its present dimensions by repeated excisions. The earliest was in 1631, already mentioned, when a strip was cut off from the whole northern border, in order to make up the township of Newtown (Cambridge). The next was in 1634, when thirty acres of meadow, on the south side of Charles River, was offered and relinquished to Newtown, in order, with the additional offer of Boston, to induce Mr. Hooker and his congregation to relinquish their purpose to remove to Connecticut. The third excision was in 1635, when Concord was granted, and trenched so far upon the land previously allowed to Watertown, that the Court granted Watertown 2000 acres of land as a compensation for the loss. The fourth excision took place in 1712, when about one-half of the land was taken off and incorporated, January 1, 1712-13, as the town of Weston. This had been commonly designated as Watertown Farms; afterwards, for a few years before the incorporation, as the Farmers' Precinct; sometimes as the third Military Precinct, or the precinct of Lieutenant Jones's company; sometimes as the Western-most Precinct, in which case Waltham was called the Middle Precinct.

§ 38. The earliest mention in the records of a boundary between the Farms and the rest of Watertown, is Mar. 13, 1682-3, when it was voted that "those that dwell on west of Stony Brook be freed from school tax in 1683." October 2, 1694, it was voted that "our neighbors, the farmers, being upon endeavors to have a meeting-house among themselves, the town consents that they may come as far as Beaver Brook, upon the country road leading to Sudbury, and so to run north and south upon a line, to the end there may be peace and settlement among us." This line was so far east as to set off to the Farms more than three-fourths of the present territory of Waltham, and about three-fourths of the land of the whole town. We find no subsequent mention of such a boundary, and it was so different from the obvious eastern boundary of Watertown Farms, and from the one afterwards adopted, that it might be suspected that there was an error in the record, and instead of Beaver Brook, it should be Stony Brook. But that vote was passed in the early stage of a very earnest controversy about the removal of the meeting-house from the eastern to a more central part of the town, and if the record is correct, it was probably passed by an accidental majority, who hoped, and intended thereby, to put to rest the project of a change of the location of the meeting-house.

§ 39. At a town meeting, held January 6, 1701-2, it was voted "that the bounds of the Farmers' Precinct for the ministry is from Charles River along the brook called Stony Brook, that cometh out of a pond called Beaver Pond, said Precinct being on the westerly side of said brook." This vote seems to be only an iteration or sanction of an order of the General Court [Records vii. p. 49], passed July 20, 1699, respecting the boundary line between the "Farmes" and Watertown. "It is Resolved and Ordered that the Bounds of s^d Precinct shall extend from Charles River to Stony Brook Bridge, and from s^d Bridge up the Brook Northerly to Robert Harrington's Farm, the Brook to be the boundary, including the said Farm and comprehending all the Farms and Farm lands to the lines of Cambridge and Concord, and from thence [the Brook] all Watertown lands to their utmost Southward and Westward bounds." On the 7th of May, 1708, the town appointed a committee (Joseph Sherman, Lieutenant Jonathan Smith, and Joseph Peirce, Sen.) "to run a line between the town and the Farmers' Precinct, referring to the ministry." This was done on the 28th of May, and the line (minutely described in the records) began at Charles River, followed up Stony Brook to Beaver Pond, "and from said pond to a black pine, at the bounds where Cambridge and Watertown and Concord meet; said Farmers' Precinct being on the west side of said brook."

§ 40. The petition of the Farmers' Precinct for incorporation was presented by Captain Francis Fulham, Lieutenant Josiah Jones, and Mr. Daniel Estabrook, and at a town meeting, December 2, 1712, upon the hearing of said petition, the town "did by a free vote manifest their willingness that the said Farmers should be a township by themselves, according to their former bounds," with proviso and conditions, viz., 1. That the Farmers continue to pay a due share of the expense of maintaining the Great Bridge over Charles River; 2. That they pay their full and due share of the debts now due by the town; 3. That they do not in any way infringe the rights of proprietors having land, but not residing among the Farmers.

§ 41. The present boundaries of Weston, on the north and east, do not correspond with those described, when it was set off as a precinct. Beaver Pond, there mentioned, is in Lincoln, and the pine, where the bounds of Cambridge (Lex.), Watertown, and Concord meet, was not far north of the centre of Lincoln, which was incorporated as a precinct, April 24, 1746, and as a town, April 19, 1754, and which was made up of land taken from the northern part of Weston, the southern part of Concord, and the western part of Lexington. Nor does Stony Brook continue to be the entire boundary between Weston and Waltham. This line of boundary, after following up Stony Brook about a mile and a half, leaves it at nearly a right angle, and runs N. 30° E. 344 rods; then N. 60° W. 124 rods; then N. 88° W. 136 rods; then N. 60° W. 76 rods, where it meets the corners of Weston, Waltham, and Lincoln. From this point the boundary between Weston and Lincoln runs, with many angles, nearly due west, until it reaches the boundary line of Wayland (originally Sudbury).

§ 42. Weston extends considerably farther south than either Watertown or Waltham, and on its east and southeast border, for 840 rods, it is separated from Newton by Charles River. The southern boundary is a line beginning at Charles River, and running W. 13° S. 993 rods, separating it from Needham, until it reaches Natick. Its western boundary is a line beginning at that corner of Needham, running N. 2° 20' E. 377 rods, separating it from Natick; then continued in the same direction 1360 rods; then N. 30° 15' E. 52 rods, separating it from Wayland, and there reaches the corner of Lincoln.

§ 43. The next excoision from Watertown took place, April 19, 1738, when Waltham was incorporated, taking off about three-fifths of her already much diminished territory. Before the incorporation of Weston, Waltham was sometimes called the Middle Precinct, or the precinct of Captain Garfield's company; afterwards the West Precinct of Watertown. When incorporated, Waltham was bounded on the south by Charles River; on the west by Weston, boundary already described; northwest by

Lincoln; north or northeast, by that line already described, beginning at Fresh Pond, and running straight west-northwest to Concord line, and separating Waltham from West Cambridge and Lexington; east by a line beginning at Charles River, and running north 48° east, until it reaches West Cambridge, and separating it from Watertown. As early as 1754, the farm of Matthew Bridge, afterwards of his son Nathaniel, in the extreme western angle of Cambridge (now W. Cambridge), was annexed to Waltham. In 1849, Waltham received an accession of between 600 and 700 acres of land on the south side of Charles River, by the annexation of a part of Newton. Nearly the whole of this tract belonged to the ancient Fuller Farm, and included about two-thirds of it. A small portion of this addition, at the southwest, belonged to the ancient Williams Farm.

§ 44. About sixteen years after the incorporation of Waltham, Watertown suffered another excision from her eastern border. The present boundary between Watertown and Cambridge (between Charles River and Fresh Pond) is not the original one, mentioned in the report of the committee, previously inserted. [See Section 81.] In April, 1754, a strip of land, about half a mile wide, was taken from the east border of Watertown and annexed to Cambridge, as appears by the following transaction of the General Court. [Records, vol. xx. p. 228-9]:

In the House of Representatives was read and accepted the following "Report on Cambridge Inhabitants' Petition, referring to Watertown, viz.: The Committee on the petition of the First Parish in Cambridge, praying that a number of the inhabitants of the town of Watertown, with their estates, be annexed to them. Having viewed the situation, heard the parties, and finding it most convenient for said inhabitants to attend the public worship of God in the said Parish, as they usually have done for many years past, and it being their desire to be set off to the town of Cambridge, as well as to the First Parish aforesaid: Report that all the inhabitants and lands within the following bounds be annexed to the Town and First Parish aforesaid, to do duty and receive privilege in the same: The dividing line between the said Cambridge and Watertown to begin at Charles River, and from thence to run in the line between the lands of Simon Coolidge, Moses Stone, Christopher Grant, and the Thatchers [on the one side], and the lands of Colonel Brinley and Ebenezer Wyeth to the Fresh Pond, so called [on the other]: All which is submitted per Joseph Pynchon per order." Read and concurred in by the Council, and consented to by the Governor, April 19, 1754. Within the strip of land thus annexed to Cambridge, Watertown still holds a wharf or landing on Charles River.

§ 45. This boundary line may be seen on the maps, beginning at the most southern point of Fresh Pond, running nearly south to Mount Auburn Street, then east along that street; then through the northeast corner of Mount Auburn Cemetery, and thence nearly south to the river. The original eastern boundary line has not been accurately ascertained; but it probably corresponded nearly with the present Vassal Lane and Sparks Street, beginning at the southeast side of the east bay of Fresh Pond, and running to the most northern point of the bend in the river. By consulting a map, it will be seen that until 1754, much the largest part of Fresh Pond was within the limits of Watertown, and since that time less than one-half of it.

§ 46. The small portion of Watertown at present lying on the south side of the river, has not the exact dimensions assigned to it in 1635, although about the same quantity of land. March 1, 1704-5, a committee (Jonas Bond, Esq., Captain B. Garfield, and Joseph Sherman) was appointed "to find out the line between Watertown and Newton, on the south side of Charles River." The committee reported, November 16, 1705, minutely describing the line, as may be seen in the town records, and which is nearly the same as that delineated in the recent map of Watertown. The line began at high-water mark on Charles River, at the northeast corner of farm, formerly Mr. Mayhew's, and ran straight southwest 2° west, $41\frac{1}{2}$ rods; then a straight line west-northwest 5° north, 216 rods; then a straight line northeast by north, 80 rods, down to the river. [On the recent map this northwest boundary is

98½ rods.] It was signed by the above committee on the part of Watertown, and by John Spring, Edward Jackson, and Ebenezer Stone, on the part of Newton.

§ 47. We have not discovered any estimate of the number of acres—of the total area of Watertown, as originally granted; but from a comparison of the known area of a large part of it with the whole of it, as seen on the map, it may be supposed to have been about 29,000 acres. The present areas of Watertown, Waltham, and Weston are as follows:—

AREA OF WATERTOWN SINCE 1764.

	Acres.	Acres.
Land, including roads,		8697 $\frac{1}{10}$
Water; half of Charles River, 395 chains, by 2 chains wide,	75	
Part of Fresh Pond,	58 $\frac{1}{10}$	
Smelt Brook and Mill Pond,	8	
	—	186 $\frac{1}{10}$
Total area,		8883 $\frac{1}{10}$ acres.

AREA OF WALTHAM, EXCLUSIVE OF THE 600 ACRES TAKEN FROM NEWTON AND ANNEXED TO WALTHAM IN 1849.

	Acres.	Acres.
In tillage,	996	
English and upland mowing,	1880	
Meadow,	464	
Pasturage,	2664	
Woodland,	2089	
	—	7998
Roads,	246	
Water,	500	
	—	8789
Land owned by the town,		152
Total area,		8891 acres.

AREA OF WESTON, SINCE THE INCORPORATION OF LINCOLN, INCLUDING 198 ACRES IN ROADS AND PONDS,

	10,732 acres.
Total area of the three towns (formerly precincts),	23,456 $\frac{1}{10}$ acres.

[See Sections 37-46.]

EARLY RECORDS.

§ † 46. There is no record extant of any municipal transactions of Watertown, of earlier date than 1634, four years after its first settlement. The record in the first volume commences with what is marked page 2; and it has been supposed that some part, at least one page, of the town records, has been lost. There is, however, good reason to conclude that only a title page is lost; that with the beginning of this volume of records, there was a commencement of a new order in municipal affairs. It was immediately after the occurrence of an important change in the government of the colony; when a house of Deputies or Representatives became a constituent part of it. As the people, from this date, began to be represented in the government of the colony, so "the ordering of the civil affairs of the town" began to be intrusted to a body of freemen, chosen annually for that purpose. Then originated that peculiarly New England municipal body, a board of select men. Previously to this date, the civil and ecclesiastical affairs of the town were commingled together, without any distinct line between them. No one had a right to

vote, unless he were a freeman; none could be admitted a freeman unless he were a church member, and the church was Congregational, wherein its affairs were managed by the votes of the members. The church officers seem to have taken the lead both in civil and ecclesiastical affairs, and it is probable that, previously to 1634, the records were kept accordingly. Whatever those records were, they are lost.

§ 47. As an illustration of the preceding view, the following transaction is adduced. On the 3d of February, 1631-2, the Court ordered that £60 be levied out of the several plantations, "towards the making of a palisado about the Newtown." A warrant was sent to Watertown, for £8, which was its proportion of that levy. Hereupon "the pastor [Mr. Phillips] and elder [Mr. Richard Browne], &c., assembled the people and delivered their opinions, that is was not safe to pay moneys after that sort, for fear of bringing themselves and their posterity into bondage." For this they were summoned before the Governor and Assistants, on the 17th of the same month, and there was "much debate;" but, being the weaker party, they or some of them, were compelled to make a retraction, and submission. [Winthrop, I. p. 70.] It is not improbable that the resistance of Mr. Browne, occasioned the magistrates to be so determined on his dismissal from the Eldership. Although the Governor says they *freely confessed their error*, the entire correctness of this statement may well be doubted. This doubt arises from the known character and sentiments of Mr. Phillips, Mr. Browne, and others of Watertown; from the "much debate," in which they defended their views of taxation without representation, and from the important results that soon succeeded. Such a confession and submission, in *such* a case, would be unlike Richard Browne, John Oldham, and John Masters.

§ 48. This transaction shows that the people were called together by the church officers; that the minister, elder, and "divers of Watertown," were summoned to answer to the magistrates for their attempted resistance; and that there is no reference to any civil or municipal organization, or authority, as would undoubtedly have been done not long afterwards.

§ 49. But this transaction deserves a conspicuous notice for a more important reason than merely for elucidating the municipal economy of a town; for there is nothing of which Watertown has so good a right to be proud. At the conclusion of an elaborate note [Winthrop, I. pp. 70, 71], Mr. Savage says, "to the agitation of this subject [by Watertown people], we may refer the origin of that committee of two from each town to advise with the Court about raising public moneys, 'so that what they shall agree upon shall bind all,' and this led to the representative body, having the full power of all the freemen, except that of elections." It was on the 9th of May, less than three months after the debate with the Watertown people, at the very next meeting of the General Court, that these Committees were appointed for the several towns; and it is also to be noticed, in the record of these committees, that the names of Mr. John Oldham and John Masters, of Watertown, are the first on the list. These circumstances should be remembered, when reading Winthrop's Journal, in the place referred to.

§ 50. The first paragraph in the town records has become very obscure by age and much handling, and some of the words are obliterated. But the volume has recently been copied by a competent person, and it is very probable that he has succeeded in restoring that paragraph to its original reading. As these records contain so much information, in so condensed a form, respecting the men and the transactions of those early times, and present it more satisfactorily than we could do by any digest or analysis, those ancient records—all that are of an earlier date than November, 1647, except the lists of possessions—are here inserted *verbatim et liberatim*. They appear to be not a full journal of transactions, and are little more than a record of ordinances enacted.

ORIGINAL RECORDS.

- § 51. "Agreed, by the consent of the Freemen, that there shall be three persons chosen for the ordering of the civill affaires; one of them to serve as Town Clerk, and shall keep the records and acts of the Town; the three chosen are William Jennison, Brian Pembleton, John Eddie.
1684. Agreed, that the charge of the Meeting House shall be gathered by a Rate iustly levied upon every man proportionally unto his Estate.
- ember 28. Agreed, by the Consent of the freemen, that Robert Seely and Abram Browne, shall measure and lay out all the Lotts that are granted.
- Agreed, that no man shall fell or cutt down any timber or trees upon the Common, without the consent of Robert Seely and Abram Browne, and otherwise to pay to the Towne for every tree 6s.
- 1684-5, January 8. Agreed, that no foreigner [illegible (?) coming out] of England, or some other plantation, shall have liberty to sett downe amongst us, unless he first have the consent of the freemen of the Towne.
- Agreed, by the freemen, that whosoever hath a Lott in a General Inclosure, shall fence it with the rest according to proportion, and if he shall refuse, the Lott shall returne to the Towne again.
- Agreed, that there shall be foure rods in breadth on each side of the River, and in length as far as need shall require laied to the use of the Ware, so as it may not be preiudicial to the water mill. Also one Hundred and fifty Acres of Ground granted to the Ware upon the other side of the River, to be laied out in a convenient place.
- Agreed, that there shall be laied out to the use of the Water Mill twenty Acres of ground nere to the Mill, & foure Rod in breadth on either side the Water, and in length as farre as need shall require, so it be not preiudiciall to the Ware.
- Agreed, that the [? Town] Clerke shall have six [pense] for every Lott of land that he shall In [roll] in the towne [. . . illegible]. [This was probably on 25 July, 1686, when it was ordered that the Great Dividends should be laid out to the 120 "Townsmen then inhabiting."]
- July 30. Agreed, by the consent of the freemen that two Hundred Acres of upland nere to the Mill shall be reserved as most convenient to make a Township.
- Aug. 22. Agreed, that whosoever being an inhabitant in the Towne shall receive any person or family upon their propriety that may prove chargeable to the Towne, shall maintaine the said persons at their owne charges, or to save the Towne harmless.
- Agreed, that (whereas there is a dayly abuse of felling Timber upon the Common) whosoever shall offend in felling any Trees without leave, shall pay for every Tree cutt down without order, 20s. to the vse of the Towne.
- 7th. Agreed, that all generall Levies henceforward, shall be raised upon what men enjoy in Lands, & also upon whatsoever men injoy in an Increasing Estate.
- Agreed, that the charges of the new meeting house being a Rate of 80lbs. shalbe levied as other generall levies for the Country.
- Agreed, that there shalbe sufficient fences Kept in Winter as well as in Summer, in all generall inclosures where English Grain is sowed, for the preservation thereof, and whosoever is faulty after 8 dayes warning, shall pay 10s. to the use of the Towne.
- 14. Agreed, that Daniel Patrick, Brian Pembleton, Richard Barnard [Browne], Ephraim Child, Abram Browne, Charles Chaddack, and John Reynolds, shall devise to every man his propriety of Meadow & upland that is plowable, and the rest to lie common.
- Agreed, that John Warrin and Abram Browne shall lay out all the Highwaies, & to see that they be sufficiently repaired.
- 30. Agreed, by the consent of the freemen, that these 11 freemen shall order all the Civill affaires of the Towne for this yeare following, and divide the Lands: Richard Browne, Abram Browne, William Jennison, Edmund Sherman, Brian Pembleton, Ephraim Child, John Loberan, John Warrin, John Batchelor, Charles Chaddock, John Eddie.
- Agreed, by the consent of the freemen (in consideration there be too many inhabitants in the Towne, & the Towne thereby in danger to be ruinated), that no forrainger comming into the Towne, or any family arising among ourselves, shall have any benefit either of Commonage or Land undivided, but what they shall purchase, Except that they buy a man's right wholly in the Towne.
- 14. Agreed, that Abram Browne shall lay out the Lotts granted by the freemen, deputed to order the Towne affares, and Robert Seely surcease to doe any more business for the Towne.
- 1686, 8 br. 10. Agreed, by the consent of the — [illegible] these 11 freemen shall

dispose of all the civill affaires of the Towne for one whole yeare: Thomas Maihew, Robert Feke, Edward How, William Jennison, John Loberan, Simon Eire, John Sherman, Brian Pembleton, Simon Stone, John Eddie, Abram Browne.

— 9. Ordered that there shalbe an Highway left sufficient at the hither end all the great dividents or Lotts.

Ordered, that if any trespass be done by great Cattle, the fence shalbe Viewed, and if the fault be in the fence, as two freemen shall iudge, then the owner thereof to pay the damage, but otherwise the owners of the Cattle are to pay as they shall iudge it.

Ordered, that if any oxen or steeres be found from under command to goe amongst the Cowes from the time that they goe out to grass till the time they are housed, it shall be lawful for any man to drive them to pound, & the owner for Every Oxe or Steere shall pay for every time 5s. to the towne.

1637-8. Agreed, at a generall Towne Meeting, that all charges arising for the Countries Service, or for the Towne Service, shalbe levied both of freemen and forrainers.

Ordered, that whosoever shall take any wood of the 40 Acres of ground granted to the Meeting House without leave, shall pay for every cart load 10s., and for every man's burthen 1s.

— 29. Ordered, that there shalbe 8 dayes appointed for every yeare, for the repairing of the Highwaies, and every man that is a Souldier or Watchman to come at his appointed time with a wheelbarrow, mattock, spade, or shovle, & for default here of, to pay for every day 6s. to the towne, and a cart for every day to pay 19s.

Dec. 30. These 11 freemen to order the civill affaires of y^e towne for the yeare to come: Thomas Mayhew, Daniel Patrick, John Whitney, Edmund James, John Firmin, John Stowers, Abram Browne, Edward Lewis, Edward Garfield, Ephraim Child, Simon Eire.

Ordered, y^t about every common field there shalbe a sufficient fence made up against the 1st of Aprill next, by every person having ground in the said field proportionally upon every Acre, and for a default here of, he shall pay 4s. for every rod unfenced within 6 daies after to the Towne.

Ordered, that there shalbe an highway betweene Ephraim Childs and Thomas Rogers ground, lying in Dorchester field, leading to y^e flats, and all the wast ground except John Bernard's two Acres to remaine common to y^e use of the Towne.

[1637-8], January 29. Ordered, that if any goats be found abroad without a Keeper, after the 10 of March next, it shalbe lawful for any man to drive them to Pound, & for every goat the owner shall pay to y^e said party 6d., and if they do any harme in any man's ground, he shall pay to the party damnified as 2 freemen shall iudge.

February 16, 1637. Ordered, by the body of freemen of Watertowne, that the 11 men deputed this present year to order y^e Towne's civill affaires, shall have power to divide all the Towne land undivided.

Ordered, that there be no Land granted to any person butting upon another man's land before he have notice of it, that he sustaine no damage by it.

Feb. 26, 1637. Ordered, that there shalbe two Rod of . . . land lying next to every man's particular meddow round about it, where it is not preidicial to the highwaies or former grants.

March 26, 1638. Ordered, y^t all y^e Lotts of ffreemen & forrainers shalbe measured and bounded by Abram Browne, & they to bring in a note of every particular Lott to be inrolled in y^e Towne booke.

Ap. 9, 1638. Ordered by y^e body of y^e ffreemen deputed this present yeare to order the Civill affairs of y^e Towne shall have power to give out y^e land upon the Towne Plott to several Persons according to their discretions.

Ap. 23, 1638. Ordered, that those ffreemen of the Congregation shall build and dwell upon their Lotts at y^e Towne Plott, and not to alienate them by selling or Exchanging them to any forrainer, but to ffreemen of the congregation, it being our real intent to sitt down there close together, and, therefore, these Lotts were granted to those ffreemen y^t inhabited most remote from y^e meeting-house, and dwell most scattered.

[A note in darker ink, on the original record as follows]: For want of a Penalty set, this order of no force.

Ordered, that in measuring out the remote meddows, every man shall take his choice according to his Lott. Abram Browne, and Thomas Bartlet, are to measure them according to their best judgments, or some others (if they fail), by y^e Townes appointment.

May 23, 1638. Ordered, y^t all the land not granted, called Pequusset Common, bounded wth the great dividents on the West, wth Cambridge line on the North, wth y^e small Lotts on the East and South, shall remaine for a Common, for the feed of Cattle, to the use of y^e Townesmen forever, and not to be alienated without y^e consent of every Townesman.

[Note in darker ink]: This order repealed at a public Towne meeting.

July 17, 1638. Ordered, y^t all those ffreemen y^t have no Lotts at y^e Towneship, shall have 12 Acre Lotts beyond Bever Plaine, and all other townesmen shall have 6 Acre Lotts in y^e said Plain.

- Ordered, that all the Land lying beyond the Flowland, and the lots granted in lieu of y^e Towneship, having y^e great dividents on the one side, Charles River and Dedham bounds on the other side, and the farme lands at the further end of it, shalbe for a Common for Cattle to the use of the freemen of the Towne, and their heires forever, & not to be alienated without the Consent of every freeman and their heires forever. [The following note in darker ink]: This granted since to the farmes by the freemen.
- October 14, 1688. Ordered, that the farmes granted shall begin at the nearest meadow to Dedham line, beyond the line that runneth at the end of y^e great dividents parrallell to the line at the end of the Towne bounds, and so to go on successively from Dedham Bounds in order as they are given out, as they w^{ch} are deputed to lay them out shall see good & appoint the proportion of meddow, being twenty Acres to One Hundred & fifty Acres of upland.
- Ordered, y^t Daniel Patrick, Abram Browne, John Stowers, Edmund Lewis, and Simon Eire, or the maior part of them, shall lay out these farmes as they are ordered.
- Ordered, y^t in laying out the Flowland, Abram Browne shall have power to include any Swamp, Rock, or Pond in any particular Lott, as he shall think meet, not counting it into y^e number of Acres.
- December 10, 1688. These 11 freemen chosen to order the Civill affaires of y^e Towne for this yeare following: Thomas Mayhew, Edward How, William Jennison, Abram Browne, Robert fkeke, John Coolidge, Thomas Bartlet, Hugh Mason, Richard Browne, Thomas Hastings, Simon Eire.
- Ordered, y^t the Highway to y^e little Plaine beyond the Mill, shalbe laid out as Edward How, William Jennison, & Richard Browne have appointed it.
- Ordered, y^t the Highway leading to Concord shalbe 6 rod broad.
- Ordered, y^t whosoever shall kill a wolfe in the Towne, shall have for y^e same 5s.
- March 30, 1689. Ordered, y^t wh^o any meddowes or uplands shalbe laid out & measured by the Surveior, y^t warning shalbe given to y^e parties y^t have propriety there, & if they faile in comming at y^e appointed time it shalbe lawfull for the surveior and two of them to Lott & lay them out.
- Ordered, y^t two faires at Watertowne, y^e one upon the first ffriday of y^e 4 month, y^e other upon the first ffriday of the 7 month, shalbe kept upon the Trayning place.
- November 27, 1689. Ordered, y^t whosoever shall dead any Trees vpon y^e Commons or Highwaies within the bound of y^e Towne, shall pay for every tree so killed 19s to y^e vse of y^e Towne.
- Ordered, y^t if the Land in View for farmes shall not suffice to accomodate the rest of the Townesmen that are behind, that then they shall have their farmes out of the freemens Common upon the same Condition that the rest have theirs.
- Ordered, that the Highwayes appointed by the Towne to be laid out by Abram Browne, from that Highway w^{ch} leades from Dorchester field to the flats, and so thorough the River, shall remaine to the use of the Towne forever.
- Ordered, that the Highway appointed by the Towne, & laid out by Abram Browne, from that Highway that leades from Robert Jennison, downe to the River, betwixt the lands of John Bernard & Jeremiah Norcrosse, with a parcell of Land adjoining to the River about half an acre needfull for the Landing of Goods, shall remaine to the use of the towne forever.
- D. 6. m 10, 1689. These 12 freemen chosen for this yeare to order all the Civill affaires of y^e Towne. Thomas Mayhew, William Jennison, Richard Browne, Robert fkeke, Nicholas Busby, David fiske, Abram Browne, John Coolige, John Warrin, Thomas Hastings, Henry Bright, Simon Eire.
- D. 31 m 10. Ordered, y^t if any of y^e freemen be absent from any publik Towne meeting at the time appointed, sufficient warning being formerly given, he shall forfeit for every time to y^e Towne 2s. 6d.
- Ordered, by y^e freemen y^t the men deputed to order the Civill affaires shall not make any order without the consent of 7 of those freemen chosen.
- D. 28, m 11. Ordered, y^t if any of y^e freemen deputed to order the Civil affaires of y^e Towne, shall absent himself from the Place of Meeting past 9 of the Clock in the fore-noone, he shall forfeit to them for every time 2s. 6d.
- Ordered, that when any Bate is to be made, there shall be sufficient Notice given to all the Townes men before to come to the place appointed.
- D. 25, m 12. Ordered, y^t the meeting House is appointed for a watch house to the use of the Towne.
- Ordered, y^t Thomas filbrick shall set up an house at the Water side, provided it be for an house to receive streay Goods, according to y^e order of Court.
- D. 24, m 1. 1640. Ordered, that there shall be a cartway through William Hammond's Lott, and Edmund James his Meddow, & so through the Lotts of John Warrin & Isaac Sterne, to fetch hay from Rock Meadow and the remote meddowes.

- D. 21, m. 2. Ordered, y^t if any person shall suffer his dog to come to the Meeting upon the Lords day, he shall forfeit for every time 1s.
- D. 3, m. 9. Ordered, that there shall be sufficient fences kept & maintained all the yeare in all generall inclosures, and whosoever is defective (except it be by common consent), having one dayes warning, he shall forfeit 10s. Also, whosoever shall wilfully brake down any fence shall forfeit to him whom the fence belongs 20s.
- D. 15, m. 10. Ordered, that all Hogs shall be Ringed All the yeare long, & if that any Hogs unringed & not sufficiently yoked shall doe any Damage, the owner shall pay to the Person Damned 5s., besides the Damage, as two men shall iudge.
- Ordered, y^t John Shearman shall execute the Towne orders, & for every execution he shall have of y^e Person offending 1s.
- Ordered, there shalbe no more farmes laid out vntill the next Towne meeting.
- D. 29, m. 10. Ordered, that all those inhabitants y^t have beene by common consent or vote taken in amongst vs, or have had dividents granted to them, shall be accepted as Townesmen, and no others.
- Ordered, that there shall be no more trees granted as yet to any upon the Common.
- These 12 freemen chosen to order the Towne Affaires for this yeare. Edward How, Thomas Maibew, William Jennison, Charles Chaddwick, Thomas Hastings, John Coolige, Hugh Mason, Simon Eire, Abram Browne, Simon Stone, Ephraim Child, Henry Bright.
- D. 23, m. 12. Ordered that the hither Plain, being subdivided into several Lotts for Plow-ground, shall be made a common field, and therefore every person that hath a Lott there shall, according to his proportion of Acres, make a sufficient fence (as specified in a former order) by the 10 of May next, and vpon that condition, Abram Browne, sarveior for the Towne, shall measure out the Land unto them, otherwise the Land is to returne to the Towne againe, according to the former order made anno 1635, febr 21. Nevertheles it shall be lawfull for any person to fence in particular his own Lott at his pleasure. This order shall likewise stand in force for the further Plain, and when Abram Browne shall measure out the ground unto them, they shall sett to there hands to that purpose, otherwise the Land is to be reserved for the Towne's use.
- D. 23, m. 1, 1641. Ordered that all the dry cattle shall be herded and kept abroad beyond Stony Brooke, and onely Bulls to be herded with the Milch Cattle (excepting such as are kept in inclosures), from the first of y^e 8 m. to the last of y^e 7 moneth, vpon forfeit of 5s. for every Beast to y^e Towne, and that no steers or sags [?] stags] of three yeares old shalbe herded with the dry Cattle.
- D. 18, m. 3. Ordered, that Abram Browne shall have 4d. upon the Acre for Surveying, Plotting, and Staking the several Lotts upon the two Plaines and the remote meddows, when he hath laid them out.
- D. 18, m. 4. Ordered, that if any one of the 9 men shall warn in any person to the Towne meeting, and that he refuseth to Come after lawfull warning, he shall forfeit to the Towne 5s.
- 18, m. 5. Ordered, y^t no Person shall dig a Pitt in the highway or Common without leave from the Townesmen, and if any shall offend, he shall forfeit to the Towne 10s. And likewise if any person that formerly hath digged a Pitt and doth not fill it up after warning, shall forfeit 10s.
- D. 21, m. 7. Ordered, that George Munnings is appointed to looke to the meeting-house, and to be free from Rates.
- D. 29, m. 9. These 12 freemen chosen for this yeare to order the Towne affaires: Edward How, William Jennison, Richard Browne, Ephraim Child, Thomas Hastings, John Coolige, Hugh Mason, John Shearman, Charles Chadwick, Simon Stone, Abram Browne, Simon Eire.
- Ordered, that when any rate is made for the Towne or Country, that it shalbe specified wherefore it is made and what the sum is. Also it shall be recorded in the Towne booke, and he that is appointed to gather it, shall give vp his account to the Towne.
- D. 4, m. 11 [1641-2]. Ordered, that Simon Eire shall write a Transcript of the Lands in a booke and give it to the Court.
- D. 1, m. 12. Ordered, that all the Land not lotted or granted out, lying next to the great Pond, shall be reserved as Common to the vse of the Towne forever.
- D. 10, m. 3, 1642. Ordered, that an highway being laied out from the Pine Swamp nigh to William Eaton's Lott, and so leading thorough the Lotts to William Paine's Lott, being two Rod wide, shalbe for the vse of the Towne forever.
- Ordered, that an highway being laied out from Justinian Holden's Lott to George Parkhurst's house, six Rod wide, and from thence to Richard Beers his lot, two rods wide, shalbe for the use of the Towne forever.
- Ordered, y^t six Acres of the Common, called Pequusset, shalbe laid out for the present necessity of John Kettle, and that Thomas Hastings shall have ten pounds for the setting

vp an House, & to be paid in by the first of the 11 moneth next, and y^t John Kettle shall dwell in it so long as the Towne thinks meet.

D. 7, m. 4. Ordered, that if any horse or mare shalbe taken in any inclosure, the fence being sufficient for great Cattle, then the owner shall pay to the person damnified, 2s. 6d., besides the dammage, as two men shall judge.

D. 5, m. 5. Ordered, that Hugh Mason, Thomas Hastings, & John Shearman are appointed to set vp a sufficient [? fence] about the Burying Place, with a five-foot pale and 2 railles, well nailed, by y^e 15 of y^e 2 moneth, and the Towne to pay them for it.

Ordered, that the divisions for farmes being Lotted out by tens, shall begin at Concord line, and so reach to the great Dividents, and so to go on successively to Dedham line, the former farmes granted and meddowes being excepted.

D. 6, m. 5. Ordered, y^t there shalbe a new Invoice taken of mens' Estates, to make the Rates by for this yeare; also y^t all Lands granted by the Towne shalbe rated this yeare.

Ordered, y^t—

	lb.	s.	d.
Land broken vp shall pay y ^e Acre,	2	10	0
Land inclosed, not broken vp, y ^e Acre,	10	0	0
The further Plaine shall pay vpon y ^e Acre,	5	0	0
The dividents y ^e remote meddows & y ^e hither Plaine,	10	0	0
The land in lew of y ^e Towne Plott, y ^e Acre,	1	0	0
The farmes shall pay vpon y ^e Acre,	0	6	0
The home meddows shall pay y ^e Acre,	1	10	0

Ordered, y^t—

	£	s.	d.	lb.	s.	d.
Mares, Steeres, and Cowes are rated,	5	0	0	1	0	0
Heifers, 2 year old, at	3	0	0	6	8	0
Calves, 1 year old, at	1	10	0	17	6	0
Calves under a year, at	1	0	0	5	0	0
Goats, at	10	0	0	2	8	0
Sheep, at	2	0	0			
Hogs a year old, at				1	0	0
Pigs 3 months old, at				6	8	0
Colts, at				17	6	0
Lamba, at				5	0	0
Kids, at				2	8	0

D. 21, m. 9. These 9 freemen chosen to order the Towne affaires this yeare: Edward How, Thomas Mayhew, John Shearman, Richard Browne, John Coolige, Ephraim Child, Hugh Mason, David fiske, Thomas Hastings.

Ordered, y^t the Remote meddowes shalbe layed out.

Ordered, y^t all Cattle shalbe feed according to their proportion of Land in Common.

Ordered, y^t all meddow, great dividents, Plowlands, & the Lands granted in lieu of y^e Towneplott, shall be layed out and bounded this yeare, following.

D. 20, m. 10. Ordered, that George Munnings and Hugh Mason [? are appointed] by y^e Towne to search and seal leather, according to the order of Court.

Ordered, y^t there shall be a rate made of £100 for to discharge these debts, following:—

	£	s.	d.
Impmte To Thomas Hastings for charges to y ^e Poore, and building y ^e house for			
John Kettle,	17	0	0
It to John Simson,	10	0	0
It. for fencing y ^e Burying place,	6	10	0
It. formerly due to y ^e officers,	30	0	0
It. for y ^e Capitall Lawes	10	0	0
It. for y ^e Court orders, Sm. 1642,	11	3	0
It. John Knolls, Pastor, for 1 quarter,	10	0	0
It. George Phillips, Pastor, for half yeare, due Jan. 1,	33	6	8

Ordered, y^t Thomas Maihew and John Shearman shall make the Rates.

D. 15, m. 8. Ordered, that all Lands y^t lie in Common (the farmes Excepted) shall be sized according to mens' proportion, for every ten Acres shall feed a cow, ox, or horse, and for every two acres feed a goat or sheepe, and for every calf, 5 Acres.

Ordered, that there be chosen foure men to view the fences in generall fields, and they are to set a fine vpon such as are defective after lawfull warning.

D. 30, m. 8. Ordered, y^t Edmund [Edward] How, Ephraim Child, David fiske, & Thomas Hastings shall view all y^e general fences, & to lay fines vpon such as are defective. A fence with 4 railles or any fence as good is counted sufficient.

D. 15, m. 6. Ordered, y^t John Shearman shall keepe weights and measures according to the order of the Court, for the Towne's vse, and also to take lost goods.

D. 9, m. 8. Ordered, y^t there shalbe a Rate made for y^e officers' wages this year, and an invoice taken of mens' estates.

Ordered, y^t y^e officers shall have the same maintenance they had the last yeare, and men shall pay their goods according as two men shall Prize them.

Ordered, y^t Nicholas Busby and John Shearman shall make the rate, and y^t John Shearman shall gather it and give it into y^e Deacons, and shall have 40s. for it.

D. 28, m. 9. These 9 freemen chosen to the Towne's affaires for this yeare—William Jennison, Hugh Mason, Nicholas Busby, Michael Bairstow, Simon Eire, Thomas Bartlet, Richard Beers, John Shearman, John Bernard.

Ordered, that the 14 lb due before for y^e officers' wages shalbe put into this rate for them, and y^e the 14 lb due from Mr. Edward [† Edmund] Browne shalbe gott in for y^e Towne's vse.

Ordered, that Abram Browne shall have power to warne in all them y^e shall fell any trees upon the Towne's Land, and for his paines shall have the 4 part of the fines due to the towne."

§ 52. From this last date, November 28, 1643, to November 9, 1647, a period of four years, the records of the transactions of the town are lost, so that, with the exception of the lists of grants and possessions of land, and the record of births and deaths, the preceding are all that are extant earlier than November, 1647, when the records assume more the form of a journal of the transactions of town meetings, sometimes embracing those of the selectmen.

§ 53. On the 9th of September, 1639, the Court "ordered and decreed that hence forward * * * there be records kept * * * of the date of every marriage, birth, and death, of every person within this jurisdiction." It appears by the colonial records, that this order was very imperfectly complied with, and on June 14th, 1642, they made it the duty of an officer of their own appointment (the clerk of writs) to perform the service, with fees therefor, and fines for neglect to perform it. The following is that order.

§ 54. "It is therefore ordered, that hereafter the clerk of writs in the several towns, shall take especially care to record all births and deaths [marriages were recorded by the magistrates] of persons in their towns; and for every birth or death they so record, they are to have allowed them the sum of 3d. and are to deliver in yearly to the recorder of the Court, belonging to the jurisdiction where they live, a transcript thereof together with so many pence as there are births and deaths recorded, and this under the penalty of 20s. for every neglect; and for the time past it is ordered, they shall do their utmost endeavor to find out in their several towns, who hath been born and who hath died, since the first founding of their towns, and to record the same as aforesaid."

§ 55. In order to insure a full compliance with this order, which "hath been in many places much neglected," the Court passed an order Mar. 7, 1643-4, "that all parents, masters, or servants, executors and administrators, respectively, shall stand charged to bring in to the clerk of writs the name of such, belonging to them or any of them, as shall either be born or die; and that the new married man shall stand likewise bound to bring in a certificate of his marriage, under the hand of the magistrate, which married him, to the clerk of the writs," and penalties were imposed for the neglect of these duties. In May, 1657, another order was passed, more particular in its requirements and more stringent in its penalties, in order to insure the accomplishment of the purposes of the foregoing order.

§ 56. Mr. Simon Eire was the first clerk of writs, appointed for Watertown, December 10, 1641, and he retained the office until October 1, 1645. The account of births and deaths in Watertown (with the exception of a few between 1648 and 1651), entered in the Boston records, and printed in the 7th and 8th volumes of the Genealogical Register, are the result of Mr. Eire's compliance with that order. It is probable that the first volume of the records of births, deaths, and marriages, was not opened, or begun to be kept, until 1648, by John Sherman. The following is on its title page.

§ 57. "The records of the births, deaths, and marriages, in Watertown; kept according to the order of the Court, made in the year 1648 [1642, as no such order was passed in 1648]. What was taken before [before John Sherman was appointed clerk of writs], was by Mr. Eire, and uncertain in the transmitting; yet in this book transcribed according to the order of the Court—so many as come to hand. 1648."

"The year by Mr. Eire supposed begun the first of March; but from 1648, the twenty-fifth of March, by John Sherman, 26 (10), 1648. The year is set upon the

head of every page, and the month and day to every entry. J.[ohn] S.[herman]. The account of the year is from the twenty-five March, in all the entries that were brought to me, John Sherman."

For the early lists of grants and possessions, see following sections.

§ 58. Marriage was regarded as a civil contract, and for a long time could be performed only by magistrates, or by other persons especially authorized therefor. As there was no magistrate, resident of Watertown, for a long time after the departure of Sir Richard Saltonstall, Watertown people, in order to be married, were obliged to go to magistrates in other towns until November, 1646, when Mr. Richard Browne was empowered to officiate on such occasions. Upon his removal to Charlestown, Capt. Hugh Mason, was, in May, 1658, appointed to the same office, and "hereby is empowered to solemnize marriages at Watertown, for preventing travel and other inconveniences." He probably retained this office until his decease, in October, 1678. Whether any held the same office between the decease of Capt. Mason and the election of William Bond to the magistracy, has not been ascertained. The earliest record of a marriage in Watertown by a clergyman, was August 10, 1686, by Mr. Bailey.

§ 59. For the above reasons, few marriages are recorded in Watertown, until after Mr. Browne was authorized to officiate. The earliest marriage on the record is that of John Bigelow and Mary Warren, in 1642, "before Mr. Nowell," and this is the only instance, where the name of the officer is recorded, until August, 1686, when a marriage was solemnized by Rev. John Bailey; and in December, 1686, a marriage was performed by William Bond, Esq., about eight years after the decease of Capt. Mason.

THE EARLY SETTLERS, THEIR RESIDENCES, AND THEIR MIGRATIONS.

§ 60. It is very difficult, if not entirely impossible at present, to make out a full and correct list of those persons who accompanied Sir Richard Saltonstall, at the first planting of Watertown, and of those who went there before 1636. It is most probable, as before stated, that their number was greater than that of the settlers of any other town planted in 1630; and there is reason to suppose, that with the exception of Boston, Watertown continued to be more populous than either of them, for twenty years. [See table and notes, p. 983.] The population became so crowded, that the people began very early to disperse, either to form new plantations, or to go to other towns already settled; and Watertown has been a prolific old hive, sending out swarms almost innumerable. In August, 1635, after the migration to Wethersfield, it was "agreed by the consent of the freemen (in consideration there be too many inhabitants in the town, and the town thereby in danger to be ruined), that no forrainer coming into the town, or any family arising among ourselves, shall have any benefit of commonage or land undivided, but what they shall purchase, except that they buy a man's right wholly in the town." [Town Records.]

§ 61. Some very considerable migrations from the town took place prior to the date of the earliest list of proprietors extant; and as some of these emigrants, if they had become proprietors, probably sold their possessions before they left, their names are not found in the records, and are not certainly known. It is indeed known that there were some very early residents, whose names are not found in the lists of possessions. A considerable number of them are known, because, either they remained proprietors after they migrated, or there is a record of their dismissal, or their names were mentioned in describing the possessions of those to whom they sold, or they had held some office, or had given names to localities. It is probable also, that some died within the first few years, whose deaths are not recorded, as the records of births and deaths, for that period, are very scanty, and those that are extant were not recorded at the time of the events.

§ 62. The first considerable migration was the colony that planted Wethersfield, the oldest town in Connecticut. Some went and took possession of Pyquag, in 1634. The next year a larger number, including some names afterwards somewhat distinguished, went there and named the plantation Watertown. Not long afterwards the Court changed the name to Wethersfield. Some of this colony afterwards were among the first settlers of Stamford, Milford, and Branford [see their names in the following catalogue, § 77].

§ 63. The next considerable migration from Watertown went to Dedham. Mr. Haven [centennial address], says, "the founders of Dedham came from Watertown." September 3, 1635, the Court "ordered a plantation to be settled about two miles above the falls of Charles River, on the N. E. side thereof, to have ground on both sides of the river," &c. ; and on March 3, 1635-6, a committee (Ensign Jennison, Mr. Danforth, and Mr. William Phelps), was deputed to set out the bounds thereof, and they reported on the 13th of the next month. On the 8th of the following September (1636), the Court named this plantation Dedham, and exempted it from public charges for three years from the first of May next. A considerable number of the names of the settlers, who went from Watertown to Dedham, are known. Others probably went there from Watertown, whose names are not found in the records, for the reason above stated. A few of the petitioners and grantees of Dedham, did not move there; among whom were John Coolidge, Thomas Hastings, and Robert Feake. Among those who are known to have gone there, were John Hayward, Lambert Chinery, Daniel Morse, Ensign Thomas Cakebread (afterwards of Sudbury), John Dwight, Henry Phillips (son-in-law of Mr. Dwight, and ~~candidate as teacher~~), John Batchelor, Ralph Wheelock (candidate as teacher), John Eaton, Dr. Henry Dengayne (afterwards of Rox.), William Barstow, and George Barstow (supposed to have gone from Watertown, where their eldest brother, Michael settled), and John Kingsbury.

§ 64. The order for planting Concord is of the same date as that of Dedham, and Capt. Thomas Brooks, the ancestor of one of the most distinguished families of Concord, went from Watertown. Timothy Wheeler, an early proprietor of Watertown, was probably one of the early settlers of Concord. Although this town cannot, with propriety, be said to be planted by Watertown people, the preceding genealogies show that numerous Concord families may trace their early lineage to Watertown.

§ 65. The next plantation, made by Watertown people, was Sudbury. At the General Court, November 20, 1637, the following preamble and order were adopted. "Whereas a great part of the chief inhabitants of Watertown have petitioned this Court, that in regard of their straitness of accommodation, and want of meadow, they might have leave to remove and settle a plantation upon the river, which runs to Concord, this Court, having respect to their necessity, doth grant their petition, and it is hereby *ordered*, that Lieut. [Simon] Willard, Mr. [William] Spencer, Mr. Joseph Weld, and Mr. [Richard] Jackson, shall take view of the places upon said river, and shall set out a place for them by marks and bounds sufficient for fifty or sixty families, taking care that it be so set out as it may not hinder the settling of some other plantation upon the same river, if there be meadow, and other accommodations sufficient for the same. And it is *ordered*, further, that if the said inhabitants of Watertown, or any of them, shall not have removed their dwellings to their said new plantation before one year after the plantation shall be set out, that then the interest of all such persons, not so removed to the said plantation, shall be void and cease, and it shall be lawful for such as are removed and settled there, or the greater part of them, being freemen, to receive other persons to inhabit in their rooms, in the said plantation; *provided*, that if there shall not be thirty families at least there settled before the said time limited, that then this Court, or the Court of Assistants, or two of the Council, shall dispose of the said plantation to any other. And it is further *ordered*, that after the place of the said plantation

shall be set out, the said petitioners, and such other freemen as shall join them, shall have power to order the situation of their town, and the proportioning of lots, and all other liberties as other towns have under the proviso aforesaid.

“And it is lastly further *ordered*, that such of the said inhabitants of Watertown, as shall be accommodated in their new plantation, may sell their houses and improved grounds in Watertown; but all the rest of the land in Watertown not improved, shall remain freely to the inhabitants, which shall remain behind, and such others as shall come to them.

“And the said persons appointed to set out the said plantation are directed so to set out the same, as there may be 1500 acres of meadow allowed to it, if it be there to be had with any conveniences, for the use of the town.” March 12, 1637-8. “The Court thinketh meet that they [of Watertown], should have liberty to sell their allotments in Watertown, and they are to give their full answer the next Court, whether they will remove to the new plantation, and John Oliver put in the room of Richard Jackson, or to lay out the said plantation, which they are to do before the next Court.”

§ 66. An order was passed September 6, 1638, allowing the petitioners, Mr. Pendleton, Mr. Noyes, Mr. Brown and company, to go on in their plantation; but an allotment of lands does not appear to have been made, until September, 1639, when the Court gave the plantation the name of Sudbury. May 13, 1640, an addition was made to their territory of one mile on the southeast and southwest sides, with conditions, and it was exempted from rates for one year from May 20, 1640. In 1649, the boundary line of Sudbury was laid out two miles further westward, for their enlargement.

§ 67. Although Sudbury was a plantation specially granted to the inhabitants of Watertown, only a small proportion of the names of the very early grantees of the lots, are found in the Watertown records, and some of those returned to Watertown, [See the following catalogue; and see Barry, pp. 154, 5, & 6.] The probable reason that so few went to Sudbury, was, that so many had migrated to Wethersfield, Dedham, and other places, as to relieve Watertown of its crowd of settlers. It will, however, be found that a large part of Sudbury families were afterwards of Watertown origin. The following Watertown names are found in the earliest lists of Sudbury grantees, viz.: Robert Betts (“Beast”), Thomas Cakebread, Henry Curtis, Robert Daniel (“Darvell”), John Grout, Solomon Johnson, John Knight, George Munnings, Peter Noyes, William Parker, Bryan Pendleton, Richard Sanger, Joseph Tainter, Anthony White, Goodman [John] Wetherill. The two sons-in-law of Elder Edward How, viz.: Nathaniel Treadway and John Stone (eldest son of Dea. Gregory Stone, of Camb.), were also original grantees of Sudbury.

§ 68. The pioneers in the settlement of Nashaway (Lancaster), were Watertown men, among whom were Thomas King, the sturdy John Prescott, Richard Linton, Lawrence Waters, Rev. Nathaniel Norcross, John Smith, Ralph and John Houghton. Numerous Lancaster families, of a later date, can trace their lineage to Watertown.

§ 69. Martha's Vineyard was first planted by a colony from Watertown. [See Mayhew, pp. 364 and 357.]

§ 70. It is known that, at an early period, removals to and fro, between Watertown and Cambridge, were not unfrequent, and some may have occurred too early to be noticed in the records. In 1632, Capt. Daniel Patrick moved to Cambridge, and not long afterwards returned to Watertown. Mr. John Masters, moved after 1632, from Watertown to Cambridge. It is highly probable, that Edmund Lockwood went to Watertown with Sir Richard Saltonstall, and that the next year, either he moved to Cambridge, or was found to have settled within the limits assigned to Cambridge. Dea. Gregory Stone moved to Cambridge about 1637. David Fisk, Jr., of Watertown, married in Cambridge, and settled there. These are a few of the instances of this kind that might be given.

§ 71. Several emigrants from Watertown were among the original proprietors of Groton, and the numerous families of the name Lawrence, Tarbell, Page, Sawtel, Holden, Stone, Knapp, Clary, Barron, Peirce, Boyden, Whitney, Crisp, Ong, some of the Morses [names found among the original proprietors]; also later settlers of the name of Cady, Headly, Prescott, Sanderson, Shattuck, some of the Fiskes, and many others in the female line, may trace their lineage to early settlers of Watertown. Emigrants from Watertown may also be found among the early settlers, of nearly all the towns in Middlesex County; and, in a considerable number of them, their descendants are probably as numerous as in Groton.

§ 72. Descendants from the early settlers of Watertown, are not less numerous in Worcester County. As evidence of this, see the histories of Framingham, Shrewsbury, Worcester, Rutland, and Spencer. The histories of other towns, if equally well written, would evince the same thing, with at least equal fulness. And it is probable that there is not a town in the western counties of Massachusetts, where there are not, or have not been, families of Watertown origin.

§ 73. Emigrants from this old hive were among the early settlers of many other towns in Connecticut, besides the very ancient ones of Wethersfield, Stamford, Branford, New Haven, and Milford, especially in the northern and eastern portions of the State, where their descendants are very numerous. They were also among the very early settlers of some of the oldest towns on Long Island; a few also went to Rhode Island. The families are also very numerous in Maine, New Hampshire, and Vermont, who are of Watertown origin. It would be an endless, but not a fruitless undertaking, to attempt to trace out fully the Watertown genealogies; and it may be seen in the preceding pages, in the attempt to trace the genealogy of only a few branches to the present time, that they are to be found in every State in the Union.

§ 74. The following is an Alphabetical Catalogue of the names of persons, known to have been proprietors or residents of Watertown, prior to the end of the year 1643; compiled chiefly from the lists of grantees and proprietors, embracing also some names derived from wills, deeds, settlement of estates, and descriptions of possessions.

§ 75. The earliest of these lists of inhabitants, is that of the grantees in the Great Dividends, which were granted in July, 1636, and it contains 120 names. [See Sect. 86-7.] The next list is that of the grantees of the Beaver Brook plowlands, "being 106 in number," and dated February 28, 1636-7, but ordered the preceding September. In June, 1637, the Remote, or West pine [? plain] meadows, were granted to "the townsmen then inhabiting, being 114 in number." [For other information respecting these and other lists, see Sections 91, 96, 97, 100, 102, &c.] Before and about the time of these grants, many changes were taking place in the population, many migrating to Wethersfield, Dedham, &c., and others arriving from England, to buy their lands and supply their places, as stated in the preceding sections, and as will be seen in the following catalogue.

§ 76. *Deputies*, or *Representatives* of Watertown to the General Court, are printed in SMALL CAPITALS; other freemen (fr.) in *italics*. Several of those who migrated from Watertown, became afterwards magistrates, deputies, or freemen of other towns or colonies. But they have not such designations in this catalogue.

An asterisk (*) denotes clerical persons; ministers and ruling-elders, but not deacons.

A cross (†) before a number denotes the date of embarkation in England, with the name, in some instances, of the place of embarkation.

A double cross (‡) denotes a selectman.

In some instances the localities of the homestalls are given. In others only the boundaries are given, as the localities are not yet satisfactorily ascertained. The term *homestall* (instead of homestead), is retained as it is the one always made use of in the early records.

- ‡ 77. *Daniel Abbot*, applied to be admitted freeman in Oct. 1680, before New Town (Cambridge) was settled, and he was adm. the next May. In Ap. 1681, the Court ordered a military watch of 4 to be kept every night at Dorchester and Watertown. About five weeks afterwards (May 18th), Daniel Abbot was "fined 5s. for refusing to watch, and for other ill behavior showed towards Capt. Patrick." As Capt. Patrick belonged to Watertown, and as no watch was ordered to be kept at New Town, there can be little doubt, but that Daniel Abbot was one of the first settlers of Watertown. He may have settled within the limits afterwards assigned to New Town [see Lockwood, p. 854]. His fine was remitted Sept. 8, 1688; and the Colonial Records (June 4, 1689), say "Daniel Abbot is departed to New Providence."
- Robert Abbot*, fr. 1684; was grantee of a homestall and meadow on the East side of Mount Auburn, and of a lot in the Great Dividends in July, 1686; all of which were bought by Roger Wellington. He went early to Connecticut [see Reg. Abbott Fam., p. 178].
- Richard Ambler*, of Wat. 1689, not a grantee, went to Stamford, Conn. His homestall was the lot in the town plot granted to Richard Beers, S. side of Belmont St. near Warren St.
- Thomas Andrews*, not a grantee, but proprietor of 4 lots; homestall S. of Camb. road, near Camb. line.
- Edmund Angier*, fr. 1640, proprietor of 8 A. East of Mount Auburn, in 1644, but probably never a resident of Wat.
- Thomas Arnold*, † 1686; fr. 1640; grantee of 8 lots and purchaser of 1 lot; moved to Providence about 1655; 2 homestalls, Orchard St., near Lex. Street.
- † *John Bachelor*, grantee of 6 lots, some, if not all, of which were purchased by J. Norcross. He probably moved to Dedham in 1687; fr. 1640.
- Nathaniel Baker*, a grantee in the Beaver Brook Plowland, 1686-7; (?) went to Hingham.
- John Baker*, fr. 1684; a grantee in the Town plot in 1688.
- William Baker*, fr. 1684; a grantee in the Great Dividends in July, 1686. [There is reason to suppose that there is a misnomer, and that these grants were made to only two, perhaps only one person of the name of Baker.]
- John Ball*. (?) On the list of Winthrop [II. p. 840], supposed to be the names of those intending to come over in 1680, is the name of "Mr. Ball." If this was the John Ball, of Concord, he may have arrived before Concord was granted; settled first in Wat., and moved to Concord, in 1685, prior to the date of the earliest list of proprietors of Watertown.
- † *Ellis Barron*, fr. 1641; not a grantee; bought the homestall, 10 A. of A. Kemball, on the E. side of Common St., adjoining on the East the lot granted to Thurston Raynor; d. 1676.
- William Barsham*, † 1680; fr. 1687; grantee of 5 lots, and purchaser of 1 lot; d. 1684. His homestall was W. of Mount Auburn, between Cambridge Road and Bank Lane.
- † *Michael Bairstow*, of Charlestown, 1636; probably moved to Wat., 1687, or 1638; fr. 1686; not a grantee, but proprietor of 8 lots; d. 1674. His homestall of 14 A., probably S. W. corner of Belmont and School Streets.
- † *Thomas Bartlett*, (?) † 1680; fr. 1686, d. 1654; grantee of 7 lots. His homestall of 14 A. N. E. corner of Common and North Streets.
- Richard Beach*, of Camb. 1685, of Wat. 1689, not a grantee; d. 1674; one lot 6 A. in the town plot, N. side of Warren St., near Lexington St.
- † *RICHARD BEERS*, fr. 1637; d. 1676; grantee of 7 lots, and purchaser of 8 lots. His homestall of 10 A. granted, was bounded N. E. by Fresh Pond, W. by Grove St.
- † *Joseph Bemis*, of Wat. 1640; d. 1684; grantee of a farm and of a meadow at Nonesuch; purchaser of 7 other lots. His homestall of 12 A., S. side of Warren Street, was made up of the two lots in the town plot, granted to Simon Stone and J. Firmin.
- John Benjamin*, † 1682; fr. 1682; first of Camb., afterwards Wat., where he d. 1645. The circumstance that his name is not in any list of grantees, renders it probable that he did not move to Wat. before 1637 or 8. His homestall of 60 A. was situated E. of Dorchester Field, and bounded S. by Charles River. He had 8 other large lots, grants to R. Feake.
- Richard Benjamin*, † 1682, of Southhold, L. I., in 1667; not a grantee, but proprietor of 2 lots.
- † *John Bernard* (Barnard), † 1684; fr. 1685; d. 1646; grantee of 12 lots, and purchaser of 2 lots. His homestall of 18 A. was on the N. side of Mount Auburn St., a little W. of School St.
- Robert Betts*, ("Best," "Beast,") a grantee in the Great Dividends and in the Beaver Brook plowlands; an original grantee of Sud., where he d. 1655, s. p., bequeathing his estate to his brother-in-law William Hunt and other relatives of this name.
- † *John Bigelow*, of Wat., 1642, fr. 1690, d. 1703; not a grantee, purchased two lots, one of which was the Great Dividend lot granted to Henry Dengayne, and the other, his homestall of 8 A., was the lot in the town plot granted to Henry Bright, Jr., on Warren St.
- † *John Biscoe*, fr. 1650, d. 1690; grantee of 27 A. in lieu of township; proprietor of at

- least 14 other lots, amounting to 509 A. From the number and value of his possessions, in 1642-44, he then being only 21 to 23 years of age, it seems probable that the lands were held in his name for his father, Nathaniel, the "rich tanner." His homestall was at the N. W. corner of Belmont and Common Streets, bounded N. by the homestall and meadow granted to John Lawrence. [See p. 819.]
- † *Nathaniel Biscoe*, not a grantee; purchased of the town a lot of 46 A., bounded E. by Lexington St., and South by the homestalls of T. Philbrick, John Stowers, Anthony Peirce. This lot passed to his son John, then to Elisha Cook, of Boston, and from him to Andrew White and Nathaniel Stearns. It was for a long time the residence of the heirs of A. White. [See White, 5, p. 639.]
- Edmund Blois*, fr. 1639, d. 1681. His wife and son embarked for N. Eng., in 1634. He was a grantee of 5 lots. His 6 A. lot in Town Plot, N. E. cor. of Main and Warren Streets.
- † [*WILLIAM BOND*, the first of the name in Watertown, but too young to be a proprietor in 1642-4. It is supposed that he came over in 1630, then aged 5 yrs., as the nephew, adopted child, and heir of Dea. Ephraim Child.]
- Nathaniel Bowman*, † 1630, applied to be admitted freeman Oct. 1630; not admitted; d. 1682. Grantee of 8 lots; homestall W. side of Common St., (sometimes called Bowman's Lane), a little S. of Belmont St. He purchased of E. Goffe a large lot in Camb. (Lex.), adjoining or near the Watertown line, and moved there.
- Thomas Boyden*, † at Ipswich, 1634; fr. 1647; was an early settler of Groton, resided some time in Medfield, again in Groton, and afterwards again in Watertown. [See Phillips, p. 872.] His homestall a little W. of Common St., adjoining Wm. Hammond.
- Thomas Boylston*, † 1635 at London, d. 1653; grantee of 2 lots, and proprietor of 6 lots purchased of Gregory Stone, 5 of which had been granted to Stone, and a homestall of 16 A., which had been granted to Thurston Raynor, and purchased by G. Stone. It was bounded E. by School Street, N. by Common land, S. by R. Linton and R. Sanderson, and W. by J. Cutler, and E. Barron. It passed to John Chinery, who married Boylston's widow.
- John Braybrook*, came from Hampton to Wat. about 1640, d. 1654. He was not a grantee, but purchased 7 lots. His homestall of 6 A., which had probably been granted to Wm. Bridges, was bounded E. by Common St., W. by Wm. Hammond, N. by J. Biscoe, S. by Timothy Hawkins.
- William Bridges*, a grantee in the two earliest grants (1636), and a farm in 1642. His homestall of 5 A. was bounded S. by Bank Lane, and was E. and near Mount Auburn.
- Thomas Brigham*, † 1635; fr. 1637; not a grantee. His lot of 14 A. was bounded S. by the river, and Sir Richard S.; E. by Camb. line and John Marrett, N. by Cambridge Street, W. by Robert Keies and Thomas Andrews. Probably he did not reside in Watertown.
- John Brigan*. (Brigham). The land of "John Brigan" was a boundary of a lot of E. Child, in 1642.
- Henry Bright*, Sen.; not a grantee; owned a homestall of 8 A. between School and Common Streets; bound E. by O. Callow, W. by E. Dix and B. Crispe, S. by T. Hastings, N. by J. Cutler.
- † *Henry Bright, Jr.*, † 1630; fr. 1635, d. 1686; grantee of 6 lots. Most of his lands came by inheritance from his father-in-law, H. Goldstone. His homestall of 7 A. obtained by purchase, was bounded S. E. by John Warren, N. E. by Water St., N. W. by William Gutterig, and S. W. by Shallow Pond, in N. E. border of Mount Auburn Cemetery.
- Thomas Bright*, bought the homestall of R. Feake, and sold it, Dec., 1640, to Col. Wm. Rainborow.
- Thomas Brooks*, fr. 1636; a grantee in the Great Dividends, and Beaver Brook plowlands, which lots he sold to S. Saltonstall.
- * † *Elder RICHARD BROWN*, † 1630; fr. 1631; a grantee of 18 lots in the town, besides 200 A. granted by the Court, out of town. In 1642, he had disposed of not less than 7 of these grants. His homestall was on the S. side of Mt. Auburn Street, probably a short distance W. of the Old Grave Yard, with the 3 A. lot of J. Prescott between his and the street. It is probable that this was his 2d residence. He had a 7 A. lot on the E. of Mount Auburn, bounded South by Bank Lane. Between this and the river he had 2½ acres of marsh. He sold these to R. Wellington. It is probable that he first settled there, and that it was while he lived there, that he was licensed to keep a ferry.
- † *Abraham Browne*, (?) † 1630; fr. 1632, d. 1650; grantee of 12 lots; purchased 4 lots. His first homestall, probably his first residence, was East of Mount Auburn, bounded S. E. by Bank Lane, W. or S. W. by R. Browne, N. by R. Wellington. Between this lot and the river he owned 3 A. of Marsh, bounded East by the Creek. His 2d homestall of 23 A. was bound N. by Sudbury Road, South by Pleasant Street, and E. by Howard Street. Upon this his descendants have continued to reside until the present time.
- John Browne*, † 1632; fr. 1633, d. 1636; grantee (to him and his heirs) 5 lots. His homestall of 13 A. was on the South side of Mt. Auburn Street, the 2d lot from the mill. In 1644, it, or a part of it, had become the property of Joseph Tainter.

- Malachi Browning**, not a grantee, proprietor of a homestall of 4 A. in 1644; d. in Boston, 1658. His homestall, N. side Camb. St., near Camb. line
- Benjamin Bullard**, not a grantee; proprietor of 6 lots in 1644. His homestall 6 A. was bound N. by Camb. line, W. by D. Fiske, E. by S. Freeman, S. by Pond Lane. This lot had been granted to John Griggs.
- Robert Bullard** d. in Wat. 1639, leaving wid. Anna; not a grantee or proprietor.
- George Bullard*, fr. 1641; d. 1689; not a grantee; in 1644 proprietor of a homestall 8 A., bounded W. by John Knowles, S. by Orchard St., N. by his sisters Maudlin and Ann Bullard, E. by E. Pickeram.
- Anne Bullard and Maudlin Bullard**, proprietors, in 1644, of 8 A., bounded W. by J. Knowles, S. by Geo. Bullard, N. by N. Theale, E. by Esther Pickeram.
- † *Nicholas Busby*, † 1637, from Norwich, Co. Norfolk; fr. 1638, d. in Boston, 1657; grantee of homestall of 6 A. and a farm of 86 A.; purchased 6 lots, one of which was a homestall, 10 A., where he probably resided; bounded N. by Fresh Pond, E. by John Daggett, W. by W. Woolcot; bought of Andrew Ward.
- Ens. Thomas Cakebread*, fr. 1635, grantee of 7 lots, which he sold to John Grout; an early grantee of Dedham; went thence to Sudbury, where he d. in 1648.
- Oliver Callow**, not a grantee; he sold his homestall (8 A., bounded E. by School Street, W. by H. Bright, Sen., E. by T. Hastings, N. by Wm. Godfrey) to William Williams.
- * *Elder Thomas Carter*, † 1635, fr. 1637, d. in Woburn, 1684; grantee of a homestall, 10 A., bounded N. by Sudbury Road, W. by Howard Street, S. by Pleasant Street, E. by (?) John Vahan. [This was afterwards the property and probably the residence of wid. Phebe Barnard.] Also a farm of 92 A. and a lot in the town plot.
- Richard Carver**, † 1637, d. 1641; grantee of a homestall, S.W. corner of Belmont and School Streets, afterwards the homestall of M. Barstow.
- † **CHARLES CHADWICK**, † 1630, fr. 1631, d. 1686; grantee of 8 lots, and purchaser of 8 other lots before 1644. His homestall of 3 A., situated between Mount Auburn and Dorchester Field, was bounded S. by the River, N. by the highway (Bank Lane), E. by Samuel Hosier, W. by Gregory Taylor.
- Leonard Chester**, † 1633; grantee of 60 A. in the Great Dividends; also 13 A. homestall sold to W. Paine; N. side of Camb. St., a little W. of Camb. line. The above grant implies that he did not move to Connecticut until after July, 1636.
- † **EPHRAIM CHILD**, † 1630, fr. 1631, d. 1668, aged 70; grantee of 9 lots and purchaser of 6 lots before 1644. His homestall of 40 A., E. of Dorchester Field, was bounded W. by John Loveran, S. by Thomas Rogers and John Benjamin, N. and E. by highway.
- Lambert Chinery**, probably † 1630, an early grantee of Dedham, returned to Wat. and d., 1674.
- Garrett Church*, fr. 1649; grantee of 9 lots. His homestall, of 8 A. (opposite the entrance to Mount Auburn Cemetery), was bounded S. by highway (Camb. Street), N. by J. Hayward, W. by C. Grant, E. by W. Woolcot.
- John Clarke**. This name, in the list of proprietors, is a misnomer for John Cloyes. [See p. 741.]
- William Clarke*, † 1630, fr. 1631, Constable of Wat., 1632; went to Ipswich, in 1633.
- Hugh Clarke*, of Wat., 1641, moved to Rox., fr. 1660, d. 1698.
- William Clarke**, † 1635; a grantee of a farm, 58 A., and he bought 4 lots.
- John Clough*, fr. 1642, not a grantee; a purchaser of 6 lots. His homestall, of 22 A., was bounded S. by Pond Road, E. by Wm. Paine, W. by highway (? School Street) and Wm. Perry, N. by Joseph Morse. This and others of his lots were bought by Wm. Shattuck. (?) He moved to Salisbury.
- John Cloyes**, of Wat., 1638, fr. 1652, d. 1676; went to Charlestown, thence to Falmouth, in 1660. His homestall was at the E. and near to Fresh Pond.
- Robert Coe**, dismissed from Wat. to Wethersfield, May 29, 1635; thence went to Jamaica, L. I.
- † **JOHN COOLIDGE**, fr. 1636, d. 1691, aged 86; grantee of 9 lots; purchased 2 other lots before 1644. His homestall, of 12 A., was bounded N. by Camb. line, S. by Pond Road, E. by D. Fiske, W. by W. Paine.
- Thomas Cooper**, d. in Wat. 1638, aged 80.
- Benjamin Crispe*, † 1630, or before; fr. 1646; moved to Groton, and returned to Watertown; was a grantee of 7 lots. His homestall, of 7 A., was bounded W. by Common St., N. by T. Smith, S. by E. Dix, E. by W. Godfrey and H. Bright, Sen.
- John Cross**, from Hampton, d. in Wat. 1640.
- Isaac Cummins*, fr. 1642; a grantee of 85 A. in the Great Dividends, and a meadow lot. Probably moved away in the autumn of 1636.
- Henry Cuttris (Curtis)**, grantee of 5 lots, and purchaser of 2 lots. His homestall, of 16 A., was E. of Dorchester Field, and bounded N. and N. W. by highway, S. and S. E. by J. Norcross. He moved to Sudbury.
- James Cutler**, grantee of 3 lots; his homestall, of 8 A., was bounded E. by Thomas Boylston, W. and N. by highway (Common Street and Pond Road), S. by Ellis Barron. He moved to Camb. Farms (Lex.)

- John Cutting, grantee of 4 lots in 1636 and 1637. Was he the John Cutting, merchant, of Boston, in 1655? [see Drake's Hist. of Boston, p. 340.]
- Richard Cutting*, † 1634, at Ipswich, fr. 1690, d. 1696, aged 78. His name is not in the lists of proprietors or grantees previous to 1644.
- Robert Daniel*, fr. 1638, d. 1655; grantee of 5 lots, and he purchased the homestall, of 18 A., of Nicholas Jacobs, bounded N. by Joseph Tainter (granted to John Browne) and William Potter, E. by John Bernard and Robert Lockwood, S. and W. by Thomas Rogers.
- John Davis, of Wat., 1642, not named among the proprietors. May it not be a misnomer for Day, or Day for Davis?
- John Day; his land is mentioned as a boundary line in 1642-4.
- Henry Dengaine (Dingham), a grantee in the Great Dividends in July, 1636, and in the Beaver Brook plowlands; an early grantee of Dedham; went to Rox., where he d. 1645.
- * Rev. Richard Denton (?), came to Wat. 1634; next year went to Wethersfield. [See Hist. Glastenbury, p. 31.]
- † *Edward Dix*, † 1630, fr. 1635, d. 1660; a grantee of 8 lots. His homestall, of 11 A., was bounded W. by Common Street, N. by B. Crispe, S. by T. Bartlett, E. by H. Bright, Sen., and T. Hastings.
- John Doggett*, † 1630, fr. 1631; grantee of 6 lots; his homestall, of 15 A., was bounded N. and W. by the [Fresh] Pond and Nicholas Busby, S. by highway, E. by W. Paine. It probably embraced the lot of Fresh Pond Hotel.
- Henry Dow*, † 1637, fr. 1638; grantee of a farm of 97 A.; purchased a homestall of 8 A., bounded E. by School Street, W. by T. Smith and E. Barron, N. by Thomas Boylston, S. by W. Godfrey. He moved to Hampton about 1648, d. 1659.
- Gov. Thomas Dudley, purchased the mill in Wat. in April, 1640, and his lands are mentioned as boundaries; but his name is not on the lists of proprietors.
- John Dwight*, fr. 1638, was a grantee in the Great Dividends and in the Beaver Brook plowlands, both of which he sold to D. Fiske; was an early settler of Dedham; d. 1658.
- John Eaton*, † probably 1630, fr. 1636; a grantee in the Great Dividends and Beaver Brook plowlands; was an early settler of Dedham; d. 1653.
- William Eaton, † 1637; proprietor, 1644.
- † *John Eddy*, † arrived at Plymouth, Oct., 1630; of Wat. as early as 1631 or 32; fr. 1634, d. 1684; grantee of 11 lots, and purchaser of 8 others before 1644. His homestall, of 40 A. (of which 16 A. were granted), was bounded S. by Mill Street, S. W. by Edward How, E. by highway, N. E. by Martin Underwood, W. by Ed. How and J. Wincoll.
- † *SIMON EIRE*, surgeon, † 1635, at London, fr. 1637, moved to Boston in 1645, d. 1658; grantee of 12 lots, amounting to 350 A., and he had purchased 4 other lots before 1644, amounting to 46 A. One of these was his homestall, of 16 A., bought of Robert Seely, bounded N. by Camb. line, W. by J. Lawrence (afterwards Edmund White), S. by John Day, E. by Isaac Hart.
- Thomas Eire, proprietor of 2 lots in 1644.
- Simon Eire, Jr., proprietor of 5 lots in 1644.
- John Ellett, of Wat., 1634, † probably 1630; grantee of 7 lots, amounting to 120 A.; his homestall, of 8 A., bounded S. by Orchard St., N. by Nathaniel Bowman, E. by Lawrence Waters, W. by Thomas Wincoll.
- † *ROBERT FEAKE*, † 1630, fr. 1631, d. 1663; grantee of 9 lots; his homestall, of 14 A., by estimation, was bounded S. E. by Bank Lane, N. W. by R. Willington, N. E. by W. Bridges, S. W. by S. Stone. This was bought by Thomas Bright, who sold it to Col. Rainborow.
- Henry Felch, not a grantee; proprietor, in 1642, of a homestall of 6 A., on the N. side of Camb. Street, opposite to Mount Auburn Cemetery, bounded S. by highway [Camb. St.], W. by W. Woolcot, N. by J. Hayward, E. by W. Eaton. It was probably a part of the homestall of 10 A., granted to A. Ward.
- Daniel Finch*, † 1630, fr. 1631; went to Wethersfield [see p. 758].
- John Finch, † 1630; a grantee in the Great Dividends and Beaver Brook plowlands; went to Wethersfield; d. 1637.
- John Firmin*, † 1630, fr. 1631, d. before 1653; a grantee of 8 lots, two of which were homestalls.
- † *David Fiske*, fr. 1638, d. 1661; a grantee of 1 lot, and a purchaser of 6 other lots before 1644. His homestall, of 22 A., granted to John Kingsburg, was bounded N. by Camb. line and J. Coolidge, S. by highway (Pond Road), W. by J. Coolidge, E. by B. Bullard.
- Nathan Fiske*, fr. 1643; proprietor of 1 lot, 9 A., in 1644; d. 1676; his homestall, of 9 A., was the lot in the Town Plot granted to R. Feake, N. side Sud. Road, opp. to A. Browne.
- John Fiske, proprietor of 6 A. in 1644; d. 1634.
- Thomas Flagg (Fleg), of Wat., as early as 1641; d. 1698; proprietor of 2 lots in 1644, one of which was the great Dividend lot, of 20 A., granted to John Rose; the other, a homestall of 6 A., bounded S. by Main St. W. by E. How, N. by J. Bemis, E. by R. Harrington.
- † John Flemming, of Wat., 1639, d. 1657; not a grantee; his homestall, of 18 A. (?), was on the N. side of Belmont Street, a little distance W. of Common Street.

John Foulgier, in 1644, proprietor of a homestall of 6 A.

Nathaniel Foote, fr. 1634; grantee of a homestall of 16 A., and 2 A. meadow, both sold to Henry Cuttris; went to Wethersfield, 1635.

Samuel Freeman, † 1630; applied, in Oct., 1630, to be adm. freeman, and was adm., 1639; was a grantee of 3 lots, and he purchased 7 other lots before 1644. Homestall, of 21 A., was made up of the lots in the town plot, granted to S. Hosier (6 A.), to C. Chadwick (6 A.), unknown (6 A.), and a part (3 A.) of that granted to B. Browne. He probably left Wat. very soon, perhaps 1631, and did not return until about 1638.

Richard Gale, of Wat., 1640, d. 1679; his homestall, of 6 A., was a part of the lot in the town plot granted to Richard Browne.

† Edward Garfield, fr. 1635, d. June, 1672; a grantee of 8 lots, and purchaser of 4 lots before 1644.

Samuel Garfield, d. 1684; in 1644, proprietor of 3 lots, grants to his father, Ed.

John Gay, † probably 1630, fr. 1635; a grantee in the Great Dividends and in the Beaver Brook plowlands.

William Godfrey, of Wat., 1639, fr. 1640, not a grantee; proprietor of 2 lots in 1644. His homestall, 6 A., was bounded E. by School St., W. by B. Crispe and T. Smith, N. by R. Linton and R. Sanderson; he moved to Hampton; d. 1671.

Edward Goffe, fr. 1635, one of the "townsmen then inhabiting," to whom 60 A. was granted in the Great Dividends in 1636; in 1644, proprietor of a homestall of 9 A., and 9 A. meadow; probably moved to Camb. in 1636. His lands, in Camb., bordered on the N. line of Watertown.

John Gosse (Goffe), † 1630, fr. 1631; d. 1644; a grantee of 9 lots.

Henry Goldstone, † 1634, d. July, 1638; grantee of 9 lots, and purchaser of 4 other lots. His homestall, of 28 A., was bounded E. by School Street, S. by Belmont Street, W. by T. Bartlett, N. by Robert Veazey. He purchased 10 A. at the opposite corner of School and Belmont Streets.

Goodridge, Goodrich. See Gutterig.

Christopher Grant, of Wat., 1634, d. 1685; grantee of 7 lots, and purchaser of 1 lot before 1644; his homestall, of 5 A., was bounded S. by Belmont St., on the E. side of the small pond, a little W. of the entrance to Mount Auburn Cemetery.

* Elder Henry Greene, fr. 1640, d. in Reading, 1648; grantee of a farm of 67 A.

John Griggs, a grantee in the Great Dividends, and in the Beaver Brook plowlands.

John Groat, of Wat. 1641; fr. 1658; proprietor of 8 lots, most, if not all, of them, purchased of Thomas Cakebread. His homestall of 13 A. was bounded E., N., and S. by highways, W. by John Bernard. It was the homestall granted to Ens. Cakebread. It is supposed to have been at the corner of Mount Auburn and School Streets. He moved to Sud. and d. 1697.

John Gutteridge, was a grantee of 25 A. in the Great Dividends, in July, 1636. Perhaps this was a misnomer, as the same lot is in the list of the possessions of William.

William Gutterig (Goodridge, Goodrich), fr. 1642, d. in Wat. 1647; grantee of 7 lots. His homestall of 5 A. was probably in or near the north border of Mount Auburn Cemetery.

Nicholas Guy, † 1633, at Southampton, fr. 1639, d. 1649; a grantee of one lot and a purchaser of 3 lots. His homestall of 7 A. purchased of B. Pendleton, was bounded E. by the meeting-house land; W. by highway; N. by J. Simson, or W. Page; S. by 3 A. granted to himself.

William Hamlet, fr. 1651; not a grantee; previous to 1644, purchased a homestall of 5 A. bounded N. by Camb. line; S. and W. by highway; W. by Edmund White.

† William Hammond, fr. 1636, d. 1662; grantee of 7 lots, and purchaser of 3 lots before 1644. His homestall, 40 A., was situated W. of Common Street and on the north it probably bordered upon or embraced a part of Pequusset Common. It was bounded E. and N. by Simon Eire, W. by John Simson [G. Parkhurst], Isaac Sterne and John Warren, S. by Thomas Boyden. [See will of Dea. H. Bright, p. 105.]

† Robert Harrington, fr. 1663, d. 1707; in 1644, proprietor of 2 lots. His homestall, 6 A., was the lot in the town plot granted to T. Hastings, and by him given to R. H. It was bounded S. by highway, N. by J. Bemis, E. by N. Fiske, W. by T. Flagg.

Isaac Hart, proprietor 3 lots, 2 of which were homestalls, and 1 a garden. He went to Lynn, afterwards to Reading.

† THOMAS HASTINGS, † 1634, at Ipswich; fr. 1635; d. 1662; a grantee of 7 lots and purchaser of 3 other lots. His homestall, of 14 A., was bounded E. by School Street, W. by E. Dix, N. by H. Bright, Sen., and O. Callow, S. by H. Dow.

Timothy Hawkins, d. 1651; a grantee of 7 lots. His homestall, of 10 A., was bounded E. by Common Street, W. by W. Hammond, N. by highway, S. by John Lawrence.

John Hayward, fr. 1634; moved to Dedham, d. in Charlestown, 1673, grantee of 7 lots. His homestall, of 24 A., was bounded N. by the Great [Fresh] Pond, W. by R. Beers, S. by Garret Church and Simon Onge, E. by W. Eaton.

- Matthew Hitchcock, a "townsman then inhabiting," to whom a lot in the Great Dividends was granted in July, 1686.
- Justinian Holden*, † at Ipswich, 1634; fr. 1653, d. 1691; proprietor of 8 lots in 1644. His homestall was bounded S. by Belmont Street, W. by Grove Street, N. by G. Parkhurst, E. by R. Holden. In 1678, he sold this lot to Rev. John Sherman.
- Richard Holden, † at Ipswich, 1634; d. in Groton, 1696; proprietor of 2 lots in 1644. His homestall, 5 A., was bounded S. by Belmont Street, W. by J. Holden, N. by G. Parkhurst, E. by J. Stebbin; sold to Rev. J. Sherman before 1653.
- Richard Hopkins, of Wat. 1632. [See Winthrop, I. p. 88.]
- Samuel Hosier*, † 1630, fr. 1634; d. 1665; a grantee of 7 lots, purchased 2 lots before 1644. His homestall was bounded S. by the river, E. by S. Stone, W. by Charles Chadwick, N. by highway (Bank Lane).
- * † ELDER EDWARD HOW, fr. 1634; d. June, 1644; grantee of 15 lots, and purchaser of 7 lots before 1644. His homestall, 40 A., was bounded W. by highway, S. by highway to Mill, E. by John Eddie, N. by his own land.
- James Hubbard, of Wat. 1638; d. that year.
- Miles Ives*, fr. 1636 [Matthias in the record]; d. 1634; in 1644 proprietor of 5 lots. His homestall, of 6 A., bounded S. by Warren St., N. by T. Arnold, E. by John Bigelow, W. by E. Garfield.
- Nicholas Jacob*, fr. 1636; grantee of a homestall of 13 A., which he sold to R. Daniel [see Robert Daniel, above]. He went to Hingham as early as 1636.
- † *Edmund James*, fr. 1631; d. before 1640; grantee of 9 lots. His homestall, of 4 A., was bounded E. by Thomas Brigham, W. by John Traine, N. by Camb. line. [? Street.]
- † Capt. WILLIAM JENNISON, † 1630; fr. 1631; returned to England and lived many years; grantee of 11 lots, of which he had sold 7 before 1644. His 50 A. homestall (sold to Rev. John Knowles), was on the N. side of Mount Auburn St., between Common and School Sts.
- Robert Jennison*, of Wat. 1637; fr. 1645; d. 1690; grantee of 6 lots. His homestall, of 6 A., was bounded N., S., and W. by highways and T. Rogers, E. by John Browne, afterward Joseph Tainter. This was in the angle where Cambridge Road and Bank Lane began, a little to the east of Mill Bridge.
- Henry Kemball*, † 1634, at Ipswich, fr. 1638; d. 1650; grantee of 9 lots. His homestall, of 6 A., was bounded E. by Common St., N. by John Winter, W. and S. by N. Bowman.
- Richard Kemball*, † 1634, at Ipswich; fr. 1635; grantee of 6 lots. His homestall, of 6 A., was bounded S. by highway, N. by Camb. line, E. by W. Hamlet, W. by Edmond White.
- Henry Kemball, Jr. (son of R.); in 1644, proprietor of 4 lots, one of which was the 50 A. lot in the Great Dividends, granted to his father.
- John Kettle, of Wat. 1642; (?) slain at Lancaster, in February, 1676.
- Robert Keyes (Keies), † 1630; of Wat. 1633; homestall of 3 A., purchased of Wm. Wilcocks, was bounded E. and N. by Thomas Brigham, S. and W. by Sir Richard Saltonstall.
- Thomas King, † 1634, at Ipswich; the pioneer in the first planting of Nashaway (Lancaster); grantee of 2 lots. His homestall, of 4 A., was probably on the N. side of the road to the Pond, on the border of Pequusset Common.
- John Kingsbury*, fr. 1626; went early to Dedham; d. December, 1644; grantee of 5 lots, held in his name in 1644, besides his homestall, sold to D. Fiske. [See D. Fiske, above.]
- Nicholas Knapp, † 1630; grantee of 8 lots. His homestall, of 16 A., was bounded S. W. by Bank Lane, S. E. by W. Barsham, N. E. by R. Browne, N. W. by R. Lockwood. In 1646, he sold his lands to B. Pendleton, and probably moved to Connecticut.
- William Knapp, † 1630; d. 1658; grantee of 7 lots, and purchaser of 1 lot before 1644. His homestall, of 16 A., was bounded S. W. by R. Lockwood, S. E. by N. Knapp, E. by R. Browne, N. E. by R. Beers, N. by highway (Camb. Road).
- William Knapp, Jr.; proprietor, in 1644, of a homestall of 4 A. on the N. side of meeting-house land.
- John Knight*, fr. 1636; not a grantee, except a farm of 270 A. in 1642; purchaser of 15 lots before 1644, amounting in all to 392 A.
- * *Rev. John Knowles*, † 1639, fr. 1650; soon after this he returned to England; grantee of a farm of 100 A., and of a homestall of 15 A., bounded N., S., and W. by highways; E. by T. Arnold and G. Bullard. He purchased the 50 A. homestall of Capt. W. Jennison.
- Edward Lamb, † prob. 1630; of Wat. 1633; left Watertown about 1648; grantee of 8 lots. His homestall, of 7 A., was bounded S. by Orchard St.; N. by N. Bowman; E. by John Knight; W. by L. Waters; sold to Charles Stearns in 1648.
- John Lawrence*, fr. 1637, of Groton, 1662, d. 1666; grantee of 10 lots, and purchaser of Isaac Cummins's grant of 85 A. in the Great Dividends. His homestall of 8 A. was bounded E. by Common Street; S. by John Bisco's homestall; N. by T. Hawkins; W. by his own 2 A. of meadow. When he moved to Groton, he sold this homestall to Bisco.
- † *Edmund Lewis*, † 1634, at Ipswich; fr. 1636, d. in Lynn, 1661; grantee of 7 lots. His homestall, of 6 A., was bounded W. by Lexington St.; N. and E. by E. How; S. by S. Freeman. In 1652, Geo. Woodward sold this lot to R. Wait.

- Richard Linton, † 1680 (? Richard Lettin, of Concord), of Lancaster, 1644; not a grantee. His homestall, of 8 A., was purchased by H. Dow. [See Henry Dow, above.]
- † *John Livermore*, † 1684, at Ipswich, fr. 1685; first of Wat., afterwards one of the original settlers of New Haven; returned to Wat. about 1650, d. 1684. He was a grantee in the Great Dividends and Beaver Brook plowlands, and of a homestall of 2 A. "bounded with the Great Pond."
- Edmund Lockwood*, † 1680, fr. 1681; probably moved to Camb. in 1681 or '82 [see p. 854]; d. about the close of 1684.
- Robert Lockwood*, fr. 1687; probably moved to Norwalk, Conn.; grantee of 8 lots, and purchaser of 1 lot before 1644. His homestall, of 18 A., was bounded N. W. by John Bernard and Robert Daniel; N. E. by W. Knapp; S. E. by N. Knapp; S. W. by Bank Lane.
- † *John Loveran*, fr. 1686, d. 1644; grantee of 9 lots, all large in proportion to most others. His homestall, of 40 A., was bounded S. by the river; E. by E. Child; W. by J. Benjamin; N. by highway.
- John Marion. Mary, dr. of John and Sarah Marion, was buried in Wat. Jan. 24, 1641-2, aged 2 m. [See pp. 208 and 755.]
- John Marrett, of Camb., proprietor of 1 lot, 1½ A. adjoining Camb. line, in 1644.
- † Capt. HUGH MASON, † 1684, at Ipswich; fr. 1685, d. 1678; grantee of 6 lots, and purchaser of two lots. His homestall, of 21 A. (20), of which 8 were granted and the rest purchased, was bounded W. by School Street; N. by T. Hastings; S. by H. Goldstone, S. Onge, and John Rogers; E. by B. Beers, and Geo. Parkhurst.
- Thomas Mason, a "townsman then inhabiting," to whom a 20 A. lot in the Great Dividends was granted in July, 1636. This is probably a misnomer for Edmund Mason.
- JOHN MASTERS, fr. 1681; moved to Camb. before July, 1685, d. there 1689.
- † THOMAS MAYHEW, † as early as 1681; fr. 1684; went to Martha's Vineyard about 1644; 6 large grants by the town. His homestall, of 10 A., with a pond in it, was bounded S. and W. by highway; E. by John Loveran, and John Benjamin.
- William Merchant, of Wat., 1641, but not a proprietor.
- † *Isaac Mixer*, † 1684, at Ipswich; fr. 1688, d. about 1655; grantee of 7 lots. His homestall, of 6 A., was bounded W. by Common Street; E. by W. Jennison; N. by Miles Nutt (a grant to J. Reynolds); S. by John Whitney (a grant to John Stickland). Previous to 1697 this lot had been bought by Joseph Sherman, or his father.
- Joseph Morse*, † 1684, at Ipswich; fr. 1685, d. about 1655; a grantee of 8 lots, and purchaser of a homestall of 18 A. His homestall, of 8 A., sold to J. Knight, 1641, was bounded N. by highway; S. by R. Woodward; W. by John Wincoll; E. by John Spring. His homestall, purchased of John Knight, 1641, was bounded N. by John Wetherill (which adjoined the Camb. line); E. by John Coolidge; S. by John Clough (afterwards sold to Shattuck) and W. Paine; W. by Common land (Pequusset Common).
- Daniel Morse*, fr. 1635; went to Dedham [see Mem. Morsee, p. 8, and Note III.] He was a grantee in the Great Dividends, and of a homestall of 9 A., bounded W. by Common Street; E. by T. Philpot and W. Jennison; N. by Strawberry (school-house) Hill; S. by lot granted to E. James, sold to John Sherman, who also purchased Morse's lot.
- George Munnings*, † 1684, at Ipswich; fr. 1688, d. in Boston, 1658; a grantee of 8 lots; purchaser of 4 lots before 1644. One of the lots purchased was his homestall, of 14 A., granted to B. Pendleton, by him sold to Peter Noyes, by him to G. Munnings, who sold it to J. Sherman, and afterwards bought it back, and gave it to his son-in-law, John Sawin. It was bounded W. by W. Jennison; N. by John Simson [passed to Geo. Parkhurst, who m. his wid.]; S. by Geo. Richardson [lot granted to R. Browne, afterwards owned by John Trainee]; E. by highway [School Street].
- John Nicarsen (also written Nichols); grantee in the Beaver Brook plowlands, in the townplot and remote meadows. Did he go to Windsor, Conn.?
- † *Jeremiah Norcross*, fr. 1653, d. 1657; grantee of 38 A. in lieu of township lands, and farm of 250 A.; purchaser of 12 lots, some of them made up several grants. His homestall of 26 A. (bought of John Page, Robert Tucke, Richard Amler, and Jacob Logan), was bounded S. by the River; W. by the way to the meadows; E. by H. Cuttris; N. by John Smith and William Barsham.
- Rev. Nathaniel Norcross* (son of Jeremiah); fr. 1648; the first petitioner for the plantation of Nashaway (Lancaster), where he resided a short time, and then returned to England.
- Peter Noyes*, fr. 1640; an original settler of Sudbury; proprietor in 1642-4 of 4 lots, granted to B. Pendleton. This purchase, and his going to Sudbury with the Watertown people, renders it probable that he settled first for a short time in Watertown.
- Miles Nutt*, fr. 1687; went to Woburn; d. in Malden, in 1671; a grantee of 7 lots, and purchaser of a homestall of 5½ A., which had been granted to John Reynolds, bounded N. by highway; S. by I. Mixer; E. by J. Sherman.
- JOHN OLDHAM, arrived at Plymouth, 1623; fr. 1681; went to Wethersfield; was slain by Indians at Block Island, July, 1686. He left Watertown earlier than the date of any

- schedule of grants, and his name does not appear as the proprietor or grantee of any lot, except the Oldham Farm.
- David Osley (Osley); proprietor of a homestall of 16 A. in 1644.
- Wid. Frances Ong, or Onge, † December, 1630, at Bristol; d. 1638 [see p. 864]. She was a grantee in the Great Dividends, the Beaver Brook plowlands, and in the town plot.
- Simon Ong, not a grantee; proprietor of 3 lots in 1644, a part, if not all, by inheritance.
- Thomas Orbear, of Wat. 1640, not a proprietor; of Charlestown, 1647.
- John Page*, † 1630, from Dedham, Eng.; fr. 1630, the first constable of Wat.; d. 1676, aged about 90; a grantee of 5 lots or more, and purchaser of 6 lots before 1644. A homestall of 8 A. was granted, but he settled on the 1st lot in the 2d Great Dividend, which he bought of E. How, and which had been granted to John Eaton. It was on or near Beaver Brook.
- William Page (son of John), d. 1665; in 1644, proprietor of 2 lots.
- William Paine*, † 1635; fr. 1640; went to Ipswich about 1640, afterwards to Boston; d. 1660; grantee of 10 lots, and purchaser of 3 lots. His homestall, of 18 A., granted, was bounded S. by the way to the Pond, N. by Joseph Moore, E. by John Coolidge, W. by J. Clough. Two of his purchases were homestalls east of Fresh Pond.
- William Palmer*, fr. 1639; went to Newbury, thence to Hampton; a grantee in the Great Dividends and Beaver Brook plowlands.
- Thomas Parish*, fr. 1637; a townsman then inhabiting, to whom a 20 A. lot in the Great Dividends was granted, July, 1636, sold to T. Wincoll.
- William Parker*, fr. 1641; (?) went to Sud. or Boston; proprietor of 2 lots in 1644.
- George Parkhurst, not a grantee; in 1644, proprietor of 6 lots, all obtained by his marriage with the wid. of John Simson, with the exception of his homestall of 16 A., bounded W. by H. Mason, E. by J. Hayward, N. by R. Beers, S. by J. and R. Holden.
- † *Capt. Daniel Patrick*, † 1630; fr. 1631; killed at Stamford, 1643; had several grants of land, but some of them sold so early, that they are not found in any schedule; but they are referred to in the description of other lots.
- John Peirce*, † 1637; from Norwich, Eng.; fr. 1638; d. about 1661; a grantee of one lot, and purchaser of 3 lots, before 1644, one of which was his homestall of 12 A., bounded N. by Belmont St., S. by R. Beach, W. by W. Parker, E. by B. Pierson. This was made up of 2 lots in the town plot, 6 A. granted to J. Smith, Sen., and 6 A. to W. Barsham.
- Anthony Peirce* (son of John); fr. 1634, d. 1678; grantee of 2 lots, one of which was 4 A., bounded S. by Belmont Street; E. by John Stowers; N. by John (Nathaniel) Bisco. He afterwards purchased 6 A. adjoining it on the west, a grant to his father. It was the 3d lot west of Lexington Street.
- Daniel Peirce*, † 1634, at Ipswich; fr. 1638; went to Newbury; grantee of 4 lots. John Prescott bought his homestall of 3 A., bounded N. and E. by highway (Camb. Road); S. by R. Browne; W. by R. Beers.
- Edward Peirce, proprietor 1639; went to Wethersfield.
- Herbert Pelham, Esq., of Camb., proprietor, in 1644, of 4 A., bounded N. W. and S. W. by highway; N. E. by G. Phillips; S. E. by E. Angier.
- † *BRYAN PENDLETON*, fr. 1634; an original proprietor of Sudbury, where he lived about two years; returned to Wat., moved to Portsmouth about 1650; d. 1681; grantee of 10 lots, most of which he sold when he moved to Sudbury; afterwards bought the lands of N. Knapp and R. Lockwood. [See Munnings and Noyes, above; also, see pp. 353 and 374.]
- William Perry*, fr. 1646, d. 1633; Jan. 1642-4, proprietor of a homestall of 8 A., bounded E. by John Clough; W. by Pequusset Common.
- Thomas Philbrick, † prob. 1630; moved to Hampton 1646; grantee of 8 lots. Issac Sterne bought 6 of these lots, one of which was Philbrick's homestall, of 12 A., bounded E. by Lexington St.; S. by Belmont Street; W. by John Stowers; N. by John Bisco [the 46 A. lot bought by N. Bisco]. This was the homestall of Samuel, youngest son of I. Sterne, and it has continued in the possession of his descendants to a very recent date.
- * *Rev. George Phillips*, † 1630; fr. 1631; d. July, 1644; grantee of 8 lots, and purchaser of 1 lot. It is probable that he always resided on his lot, adjoining the homestall of Sir Richard Saltonstall, at the east of Mount Auburn.
- Henry Phillips, went from Wat. to Dedham about 1636, as candidate for teacher (minister).
- Thomas Philpot, proprietor of a homestall, 7 A., bounded E. by M. Barstow; W. by J. Sherman; N. by Strawberry Hill; S. by W. Jennison. [See Section 110.]
- John Pickeram, d. in Wat., Dec. 1630.
- Wid. Esther Pickeram, grantee of 7 lots. Her homestall of 8 A. (probably originally 16 A.), was bounded E. by Thomas Wincoll; S. by highway; N. by N. Theale; W. by George Pickeram.
- George Pickeram, in 1644, had a homestall of 8 A. (prob. half of the paternal homestall), bounded E. by E. Pickeram; S. by highway; W. by Geo. Bullard; N. by N. Theale.

- Bartholomew Pierson*, of Wat. 1610; fr. 1648; moved to Woburn. He purchased two homesteads. The first was bounded N. by Belmont St.; S. by Edm. White; W. by John Peirce. The 2d lot was the homestead granted to John Stowers. [See p. 910.]
- † *Roger Porter*, † 1638, at Southampton; fr. 1639, d. 1654. In 1644, he owned a lot between the homestead of E. Child and the River.
- William Potter*, † 1635; fr. 1640; (?) moved to Rox. about 1646; grantee of 3 lots, and purchaser of one or more. His homestead, of 6 A., was on the S. side of Camb. Road, bounded S. by Robert Daniel; E. by John Bernard; W. by J. Tainter and J. Bernard.
- John Prescott*, of Wat., 1641; fr. 1660: a first settler of Lancaster. He was grantee of a farm of 90 A., and he purchased 5 other lots. He bought the homestead, 8 A., of D. Peirce. [See D. Peirce, above.] He bought the lots in the Great Dividends and in Beaver Brook plowlands, which had been granted to John Griggs, and a lot in the remote meadows, which had been granted to D. Peirce.
- John Prince, a very early settler of Wat. [See p. 916.]
- Col. William Rainborow, not on the list of proprietors. Dec. 17, 1640, he bought of Thomas Bright a homestead, which had been granted to R. Feake, near Mount Auburn, on the east.
- Thurston Rainer, † 1634, went to Wethersfield in 1635, and thence to Stamford in 1641. He was grantee of a homestead, of 16 A., which he sold to Gregory Stone. [See Boylston, above, p. 1006.]
- John Reynolds*, of Wat., 1635, perhaps 1630; fr. 1635; went to Wethersfield, and thence to Stamford. He was grantee of a homestead, 5½ A., bounded N. by the highway; S. by Isaac Mixer; E. by John Sherman. It was bought by Miles Nutt. [See M. Nutt, above.]
- Robert Reynolds*, fr. 1634, dismissed from Wat. to Wethersfield, May 29, 1635, probably returned to Boston; d. 1659. [See p. 912.]
- George Richardson, a grantee of 25 A. in the Great Dividends in 1636, and of a farm 39 A., in 1642. He was at one time proprietor of the 12 A. lot granted to R. Browne, afterwards owned by J. Trainee; bounded W. by W. Jennison; N. by Geo. Munnings (q. v.), S. by J. Grout; E. by highway.
- John Richardson, a grantee in Beaver Brook plowlands; perhaps a misnomer for George.
- Thomas Rogers*, † prob. 1630; fr. 1637; d. 1638, aged 50; grantee of 8 lots. His homestead, 18 A., was bounded E., N., and S. by highway, "Crooked Lane;" W. by E. Child. After his death this lot was bought by J. Sherman.
- John Rogers*, fr. 1637, d. 1674; aged 80. His homestead, 4 A., was bounded S. by Belmont St.; E. by Grove Street ("Drift Way"); N. by H. Mason; W. by S. Ong.
- John Rose, grantee of 20 A. in the Great Dividends, and 3 A. in Beaver Brook plowlands; went to Wethersfield, and thence to Branford, Conn.
- Thomas Ruck, proprietor before 1643; probably never resident of Wat. [See I. Sterne, p. 1014.]
- SIR RICHARD SALTONSTALL**, founder of the town, † 1630; returned in 1631. [See p. 915.] He was grantee of 11 lots in the town, amounting to 558½ A. His homestead 16 A., was bounded N. E. by T. Brigham and R. Keies; S. E. by the River; S. W. by highway; N. W. by G. Phillips. This and other lots passed to his son Samuel; others to son Henry.
- Richard Saltonstall, Jr.*, then aged 20, undoubtedly went to Wat. with his father; fr. 1631, returned to Eng., Nov. 1631; returned to N. England in 1635, and settled in Ipswich.
- Robert Saltonstall, of Wat. prior to 1642; settled in Boston, d. 1650.
- Samuel Saltonstall, d. in Wat., 1696; received several of the lots granted to his father, and purchased the two lots granted to Thomas Brooks.
- Henry Saltonstall, in 1644 was proprietor of farm of 200 A., and meadow of 100 A. (88 A.) granted to his father. He returned to England.
- Robert Sanderson, fr. 1639, came from Hampton to Wat. about that time; moved to Boston about 1653; was proprietor of two lots in 1644. His homestead, 6 A., was bounded E. by School Street; S. by R. Linton; W. and N. by T. Boylston; both lots by his wife.
- Richard Sawter, of Wat., prior to July 1636; a first settler of Groton; d. 1694; grantee of 7 lots. His homestead, of 5 A., was bounded S. by highway; N. by N. Busby and Edmund White; E. by Drift Way; W. by W. Clarke. This was S. E. of Fresh Pond.
- Robert Seeley*, † 1630, fr. 1631; moved to Wethersfield about 1635; was one of the original settlers of New Haven. His homestead, 16 A., E. of Fresh Pond, bought by S. Eire.
- William Seger. His land a boundary in the Town Plot in 1644. [? Hagar.]
- William Shattuck, of Wat. about 1642, d. 1672, aged 50. In 1644, proprietor of 2 small lots on the east border of Pequusset Common, adjoining the large homestead of J. Clough, which he not long afterwards purchased.
- Abraham Shaw*, fr. 1637, d. 1638. He went to Dedham so early that his name is not on the lists of grantees or proprietors; but he had been one of the larger proprietors. [See Woolcott, p. 668.]

- Edmund Sherman*, fr. 1686; returned to Dedham, England; a grantee of 5 lots. His homestall of 7 A. was bounded S. by Belmont Street; 8d lot East of Grove Street, and was purchased by John Stebbin. N. Busby bought his Great Dividend lot of 50 A.
- † *CAPT. JOHN SHERMAN*, † 1684, fr. 1687, d. 1691. He had only 3 grants: 1st, 6 A. in town plot, which he sold to E. How; 2d, 16½ A. in lieu of township, and 8d, a farm lot of 171 A. Previous to 1644 he had purchased 10 lots, 7 of which had been granted to Thomas Rogers, and one was the 50 A. lot granted to R. Browne in the Great Dividends. His homestall, which passed to his son Joseph, was situated on both sides of Common Street (then called Bowman's Lane), immediately south of Strawberry [school-house or meeting-house] Hill.
- * *Rev. John Sherman*, † 1684, dismissed to Wethersfield, 1685; went to Milford, 1641; dismissed thence to Wat., Nov. 1647; fr. 1669, d. 1685. It is supposed that he lived on the E. side of Grove Street, between Belmont and Mount Auburn Streets, and perhaps this was a part of the 40 A. meeting-house lot. The town granted him the use of a part of it, for firewood. He probably settled first on a lot bought of R. Holden, N. of Belmont St.
- John Simson*, † probably 1680, of Wat. 1634, d. June, 1648; grantee of 8 lots, of which 5, including his homestall, were held the next year by George Parkhurst, who had married his widow. His homestall, of 12 A., was bounded E. by highway (School St.); W. by W. Jennison; N. by Michael Barstow; S. by Geo. Munnings. [See Barstow and Munnings above.]
- John Smith, Sen.*, fr. 1639; grantee of 6 lots. His homestall, of 18 A., was bounded S. E. by Bank Lane; S. W. by R. Browne and W. Barsham; N. W. by Division line; N. E. by S. Hosier.
- John Smith, Jr.*, supposed to have settled in Lancaster, d. 1669.
- Francis Smith*, fr. 1681; grantee of 8 lots. His homestall of 6 A. and adjoining 2 A. of marsh, were bounded S. by the River; N. by John Smith; E. by Henry Cuttris; W. by J. Norcross. He probably moved to Reading about 1642.
- Daniel Smith*, d. 1660; proprietor in 1644 of 8 lots. His homestall, of 6 A., appears to have been the West half of the homestall granted to John Bernard, q. v.
- Thomas Smith*, † 1635; fr. 1637; d. 1693, aged 92; grantee of 8 lots. His homestall of 8 A. was bounded W. by Common Street; N. by E. Barron; E. by R. Linton and W. Godfrey; S. by B. Crispe; sold to William Perry, July, 1651.
- John Spring*, † 1634, at Ipswich; grantee of 8 lots. His homestall, of 2 A., was bounded N. and E. by highway; W. by R. Woodward; S. by Martin Underwood.
- † *Isaac Sterne* (Stearns), † 1630, fr. 1631, d. 1671; a grantee of 10 lots; purchaser of 8 other lots before 1644, two of which were the 10 A. remote meadow, and 60 A. lot in Great Dividend granted to W. Jennison, and bought of T. Ruck. In 1646, he purchased 6 of the lots granted to Thomas Philbrick. [See pp. 987 and 88.]
- John Stebbin*, of Wat. 1640; fr. 1647. In 1644, proprietor of a homestall of 7 A., which was granted to Edmund Sherman, q. v.
- John Stickland* (Stickline and Strickland), † 1629; fr. 1681, dismissed from Wat. to Wethersfield, May 16, 1635; grantee of a homestall of 16 A., which was bought by John Whitney. [See p. 950.]
- † *Simon Stone*, † 1635; at London; fr. 1636, d. 1665, aged 80; grantee of 8 lots. In 1644, he had become proprietor of 5 other lots, one of which, his homestall of 38 A., was made up of several of the small lots purchased, and was bounded S. by Charles River; E. by R. Wellington; W. by C. Chadwick and S. Hosier; N. by his own land (the 12 A. granted). The 38 A. homestall, and the 12 A. of upland granted, were afterwards reckoned as his homestall of 50 Acres. It was on the S. of Mount Auburn, and probably embraced a part of the lands in that cemetery.
- Gregory Stone*, fr. 1636; moved to Camb. about 1637. He was grantee of 5 lots, all sold to (or for) Thomas Boylston, and he was purchaser of the homestall, 16 A., of T. Raynor. [See T. Raynor and T. Boylston, above.]
- † *John Stowers*, fr. 1636, went to Newport, R. I. He was grantee of 6 lots, and before 1644, he had purchased at least 11 other lots. His homestall, granted, was bounded S. by Belmont St.; E. by T. Philbrick [afterwards of Samuel Stearns and his descendants]; W. by Anthony Peirce; N. by John [Nathaniel] Bisco. It was the 2d lot West of Lexington St., and it was afterwards the parsonage, or a part of it, where Rev. Samuel Angier resided. [See B. Pierson, and G. Bullard, above.]
- WILLIAM SWAINE*, † 1635; fr. Mar. 1635-6; went to Wethersfield in 1636.
- Samuel Swaine*, grantee of a 60 A. lot in the Great Dividends, July, 1636. A part of the homestall of Deacon Simon Stone was bought of John Swain. Were these (Samuel and John) misnomers for William?
- William Swift*, grantee of a 40 A. lot in the Great Dividends, and 5 A. in Beaver Brook plowlands; probably left town before June, 1637. He also owned a house and lot in Wat. [See p. 596.]

- Philip Taber*, fr. 1634; a grantee of a lot in the Great Dividends, and 4 other lots. [See p. 956, and Woolcott p. 668.]
- Joseph Tainter*, † 1638, at Southampton; d. 1690, aged 77; not a grantee, but in 1644 a proprietor of two homesteads. The 1st, of 6 A., was bounded N. by the highway (Camb. Road) and John Bernard; S. by R. Daniel; E. by W. Potter; W. by B. Jennison. It was part of a grant to John Browne. His 2d homestead, of 18 A., was bounded E. by Lex. St., S. by Main St., W. by E. How; N. by S. Freeman. It was made up of 8 lots in the town plot, granted to S. Eire; G. Taylor, and a part (6 A.) of the lot granted to D. Patrick. The other 3 A. of D. P.'s lot was the 3 A. lot which E. How bought of J. Vahan.
- Gregory Taylor*, † prob. 1630, of Wat. 1632; fr. 1634; a grantee of 7 lots, and purchaser of another lot before 1644. His homestead, of 6 A., was bound S. by the River; N. by J. Foulgier; E. and W. by C. Chadwick. This was probably a short distance S. W. of Mount Auburn.
- Thomas Taylor*, in 1644, proprietor of a homestead, 5 A., bounded N. E. by John Gosse; N. W. by highway; S. E. by S. Hosier; S. W. by John Foulgier. He went to Reading.
- Nicholas Thele* (or Theale), not a grantee; in 1644 proprietor of 5 lots. His homestead, 6 A., was bounded N. by Belmont St.; S. by Geo. Pickeram; E. by N. Bowman.
- Henry Thorpe*, of Wat. before 1642; fr. 1646, d. 1672; in 1642 proprietor of two lots, one of which, 8 A., was bounded N. by Camb. line; E. and S. by Fresh Pond; W. by D. Smith. Before 1644, this lot became the property of Isaac Hart.
- John Tomson*, † prob. 1630; fr. 1635, d. 1689; aged 38. He was grantee of lots in the Great Dividends, and in the Beaver Brook plowlands.
- John Traine*, † 1635, d. 1681; not a grantee; before 1644, purchaser of 8 lots. His homestead, of 12 A., was a grant to Richard Browne, who probably sold it to G. Richardson. [See G. Richardson, above.]
- Nathaniel Treadway*, an original grantee of Sudbury. About 1644, upon the decease of E. How, his father-in-law, he moved to Wat., and inherited much of his estate.
- Robert Tucke*, from Gorlston Co., Suff.; of Hampton, 1635; fr. 1639; a grantee of 5 lots. His homestead, of 7 A. (sold to J. Norcross), was bounded S. by the River; N. by W. Barsham; E. and W. by J. Norcross.
- John Tucker*, a grantee in the Great Dividends, and Beaver Brook plowlands; probably went to Hingham in 1637.
- Martin Underwood*, † 1634, at Ipswich; fr. 1634; d. 1672; a grantee of 8 lots. His homestead 1 A., was bounded E. by highway; W. by B. Woodward; N. by J. Spring.
- John Vahan*, a grantee of 20 A. in the Great Dividends; 2 other lots in Wat. were bought of him by E. How.
- Robert Veazey*, d. as early as 1644, and his wid. Mary m. George Parkhurst, Jr.; a grantee of 8 lots and purchaser of 2 lots. His 8 A. homestead was bounded E. by School Street; S. by H. Goldstone [in one schedule H. Bright, Jr.]; N. by H. Dow; W. by T. Bartlett and E. Dix.
- Richard Waite*, of Wat. 1638; d. 1669, aged 60; grantee of a farm of 60 A., and purchaser of 5 other lots. His homestead, of 6 A., was the grant in the town plot to J. Doggett, and bounded S. and E. by highways; N. by John Whitney, Jr.; W. by Edm. White.
- Andrew Ward*, freeman 1634, dismissed from Wat. to Wethersfield, May, 1635; moved thence to Stamford; grantee of a homestead, 10 A., bounded N. by Fresh Pond; E. by Drift Way and John Doggett; W. by W. Wolcott; S. by Jonas Eaton. Nicholas Busby bought this lot, and perhaps this "Drift Way" was what was sometimes called Busby's Lane. In the records there is mention of Ward's Meadow.
- John Warner*, grantee of 7 A. in Beaver Br. plowlands [see Stone [1.], p. 950].
- † *John Warren*, † 1630; fr. 1631; d. 1667, aged 82; grantee of 11 lots. His homestead, of 12 A., bounded W. by highway [Lexington St.]; E. by W. Hammond; N. by J. Bisco; S. by J. Sterne. His first homestead, of 5 A., situated N. E. of Mount Auburn, was sold early to H. Mason, and he moved to the above-described lot, for the sake of larger accommodations.
- Lawrence Waters*, of Wat. 1635; a first settler of Lancaster; a grantee of 7 lots. His homestead was bounded S. by Orchard St.; N. by N. Bowman; E. by Edward Lamb; W. by J. Ellet.
- Jonas Weeds*, † 1630; fr. 1631; dismissed from Wat. to Wethersfield, May, 1635.
- † *Roger Wellington*, of Wat. 1636; fr. 1690; d. 1698, aged about 88; grantee of 7 lots and purchaser of 8 lots, one of which was his homestead, of 14 A., bounded E. by E. Goffe; N. E. by John Warren and the Little Pond; N. W. by W. Gutteridge, Edmund White, and S. Stone; S. E. and N. by his own meadow, Abraham Browne, and Stone. This lot, or a part of it, and his 3 A. meadow were grants to Robert Abbott. It was situated East and near the border of Mount Auburn Cemetery.
- John Wetherill*, fr. 1642, d. 1672; proprietor of a homestead of 18 A., bounded N. and E. by

- Camb. line; S. by Joseph Morse and Common land; W. by the Common land [Pequisset Common] and the *Townhouse*; bought Dec., 1641, of J. Knight.
- Timothy Wheeler, before 1644, proprietor of a homestall of 7 A., bounded S. E. by W. Woolcot; N. by Henry Bright, Jr.
- * *Rev. Ralph Wheelock*, fr. 1689, went to Dedham about 1686.
- Anthony White, † 1634, at Ipswich, an original grantee of Sudbury, returned to Wat. about 1643-4.
- Emanuel White, of Wat., 1636; grantee of 6 lots; probably left Wat. before 1642. His homestall, of 15 A., was bounded S. W. by E. How; N. W. by J. Eddy; E. by highway.
- Edmund White, of London; not a grantee, but in 1644, proprietor of 15 lots, three of which were homestalls. In 1646, other lots were conveyed to him. [See Woolcott, p. 668.]
- John White, in 1644 proprietor of a homestall, of 7 A., bounded E. and S. by highway; W. by B. Windes [after. of W. Paine]; N. by swamp. This was at the E. or S. E. of Fresh Pond.
- † *John Whitney*, † 1655, at Ipswich; fr. 1636; d. 1673, aged 74. He was a grantee of 9 lots, and purchaser of one lot of 16 A., granted to John Stickland; bounded E. and S. by W. Jennison; W. by M. Underwood; N. by I. Mixer. In 1697, his son Joshua Whitney sold this lot to Dea. Nathan Fiske.
- John Whitney, Jr.*, † 1635; fr. 1647, d. 1692, aged 68. In 1644, he was proprietor of 8 lots. His homestall of 8 A. was bounded N. W. by highway; S. W. by E. Lewis; S. by E. How; E. by G. Phillips; was a grant to his father.
- William Williams, not a grantee; in 1644, proprietor of 2 lots, one of which was the homestall of O. Callow, q. v. He purchased the other lot of O. Callow.
- Thomas Wincoll, of Wat., 1636; d. 1657, aged 70; grantee of a lot in the Great Dividends, and, (?) in the Beaver Brook plowlands. [This last grant, in the record, is to his son John, probably a misnomer.] In 1644, he was proprietor of 8 other lots. His homestall, of 24 A., was bounded N. by Orchard St.; E. by J. Knight; W. and S. by R. Woodward, E. How, and T. Arnold.
- † JOHN WINCOLL, fr. 1646; moved to Kittery about 1662; not a grantee; purchaser of 5 lots before 1644, and after the death of his father, inheritor of his lands.
- Barnabas Windes*, † prob. 1630; fr. 1635; moved to Southhold, L. I.; grantee of 6 lots. His homestall, of 7 A., was bounded S. by the highway (Camb. Road); N. by N. Busby; W. by J. Doggett; E. by J. White. This lot was bought by W. Paine.
- John Winter, d. 1662; a grantee of 6 lots. His homestall, of 6 A., bounded E. and N. by highway; S. and W. by Common land, was granted "upon condition he useth his trade of tanning." He had another homestall, of 6 A., granted, bounded N. by Belmont St.; E. by Common St.; S. by H. Keball; W. by N. Bowman.
- Richard Woodward, † 1634, at Ipswich, d. 1665, aged about 76; grantee of 9 lots; purchaser of 6 lots before 1644. His homestall, of 12 A., was bounded E. by J. Spring, M. Underwood, and highway; N. W. by J. Wincoll; N. E. by John Knight and John Wincoll.
- George Woodward* (son of Richard), † 1634, at Ipswich; fr. 1646; d. 1676. In 1644, proprietor of a homestall of 10 A., bounded W. by Lex. St.; E. by E. How and R. Woodward; N. by Richard Benjamin.
- John Woolcot; fr. 1635; d. 1638.
- Winifred Woolcot, wid. of John; grantee of 6 acres in the town plot, and of a farm of 183 A.; in 1644, proprietor of 4 other lots. Her homestall, of 8 A., was bounded S. by the highway [Camb. Road, opposite to Mount Auburn Cemetery]; N. by J. Hayward; W. by Garret Church; E. by Henry Felch.
- William Woolcocks* [Wilcox]; fr. 1636, of Camb.; proprietor, about 1640, of the homestall, of 8 A., some time held by R. Keies, q. v.

§ 78. FREEMEN.—The following is a list of the freemen of Watertown, admitted previous to the union of the colonies of Plymouth and Massachusetts Bay, with the date of their admission. In order for such admission, it was necessary to be a church-member, and for this reason there were some men holding respectable social positions, who never were thus admitted, or not until advanced age. It was not necessary, however, to be a church-member, or a freeman, in order to hold office in the town or appointments from the Court. This could be done by taking the oath of fidelity, and, in some instances, townsmen, who were not freemen, were allowed to vote. Thomas Mayhew held a responsible appointment from the Governor and Assistants, more than two years before he was admitted freeman. Joseph Bemis and Thomas Flagg, were never admitted, although they were both selectmen, and held other offices. John Bigelow, Sen., took the oath of fidelity in 1652, but he

was not admitted freeman until April, 1690, at the age of 73. Roger Wellington was not admitted until 80 or 81 years of age, when he had been many times selectman. William Bond was admitted in 1682, more than 20 years after he had been selectman, juror, constable, and likewise town clerk, and only a short time before he was elected a magistrate. "Mr." William Goddard, was admitted in 1690, more than 20 years after he was a selectman. John Nevinson, being a churchman, was never admitted.

§ 79. A star (*) prefixed to a name denotes those who applied in Oct., 1630, to be admitted. Among those who applied at that time, was Nathaniel Bowman, of Watertown, whose name does not appear in the list of freemen. It will be seen that some of the very early settlers and proprietors, or natives of Watertown, were admitted freemen after they had moved to other towns. This mark (?) is prefixed to the names of freemen, who were early proprietors, where there is an uncertainty or improbability as to their having ever been residents.

- 1631, May. *Mr. George Phillips.
- *Mr. Richard Browne.
- Capt. Daniel Patrick.
- *Serj. John Stickland.
- Mr. John Oldham.
- *Edmund Lookwood.
- *John Page.
- *John Doggett.
- *Ephraim Child.
- *Robert Seeley.
- *Mr. William Clarke.
- *Mr. Robert Feake.
- *Samuel Hosier.
- *Charles Chadwick.
- Jonas Weede.
- Mr. Richard Saltonstall (Jr.)
- *Mr. William Jennison.
- *Daniel Abbott.
- John Warren.
- Daniel Finch.
- Mr. John Masters.
- Isaac Sterne.
- John Firmin.
- John Gosse.
- Francis Smith.
- 1632, Mar. Abraham Browne.
- 1632, Nov. John Benjamin.
- 1638, Mar. John White.
- John Smith.
- 1634, May. Thomas Cakebread.
- Edward How.
- John Hayward.
- Andrew Ward.
- Mr. Thomas Mayhew.
- 1634, Sept. Bryan Pendleton.
- Anthony Peirce.
- John Bernard.
- Martin Underwood.
- (?) Samuel Smith.
- John Browne.
- John Eddy.
- Robert Abbot.
- Robert Coe.
- Nathaniel Foote.
- Robert Reynolds.
- 1635, Mar. Hugh Mason.
- George Munning.
- Edward Dix.
- Thomas Bartlett.

- 1635, Mar. John Prince.
- John Wolcott.
- May. Barnabas Wines.
- John Reynolds.
- Henry Bright.
- Thomas Hastings.
- John Livermore.
- John Batchelor.
- John Tompson.
- John Gay.
- Richard Kemball.
- Daniel Morse.
- Edward Garfield.
- 1635, Sept. Richard Woodward.
- 1636, Mar. Nicholas Jacob.
- John Whitney.
- William Swain.
- John Kingsbury.
- Michael Barstow.
- 1636, May. John Knight.
- William Hammond.
- Mathias [(?) Miles], Ives.
- Edward Goffe.
- Edmund Lewis.
- John Stowers.
- John Smith (? Jr.)
- John Eaton.
- Edmund Sherman.
- John Coolidge.
- Gregory Stone.
- Simon Stone.
- John Loveran.
- (?) William Wilcocks.
- (?) Edward White.
- Thomas Brooks.
- 1637, Mar. Abraham Shaw.
- Robert Lockwood.
- William Barsham.
- Richard Beers.
- Thomas Carter.
- Richard Waite.
- 1637, Ap. (?) Thomas Bingham.
- Simon Eire.
- John Lawrence.
- 1637, May. Thomas Smith.
- Thomas Rogers.
- John Sherman.
- John Rogers.
- Miles Nutt.

- 1688, Mar. John Pearce (Peirce).
Nicholas Busby.
David Fiske.
- 1688, May. Isaac Mixer.
Henry Kemball.
Henry Dow.
Daniel Peirce.
- 1689, Mar. John Dwight.
Henry Phillips.
Robert Daniel.
- 1689, May. *Samuel Freeman.
Nicholas Guy.
Edmund Blois.
Roger Porter.
- 1689, Sept. John Cross.
Robert Tucke.
Robert Sanderson.
- 1640, May. William Paine.
(?) Mr. Thomas Ruck.
(?) Timothy Wheeler.
Henry Green.
William Godfrey.
Thomas Arnold.
(?) Peter Noyes.
William Potter.
(?) Samuel Morse.
- 1641, June. Ellis Barron.
William Parker.
George Bullard.
- 1642, May. John Clough.
John Wetherill.
Samuel Thatcher.
Isaac Cummings.
Robert Peirce.
- 1648, May. Nathan Fiske.
George Parkhurst.
Nathaniel Norcross.
- 1644, May. John Gay.
(?) Herbert Pelham.
John Stimson.
Lambert Chinery.
Robert Jennison.
John Warren (Jr.)
- 1645, May. Joseph Underwood.
- 1646, May. Benjamin Crispe.
Henry Thorpe.
George Woodward.
Charles Sternes.
John Wincoill.
- 1647, May. William Bridges.
John Stebbin.
John Whitney, Jr.
David Fiske (Jr.)
Thomas Boyden.
Richard Hassell.
- 1648, May. Bartholomew Pierson.
- 1649, May. Garrett Church.
Joshua Stubbs.
1659. Mr. John Knowles.
John Ball.
Robert Pearse (Peirce).
- 1651, May. Richard Whitney.
(?) William Hamlet.
- 1652, May. John Sawin.
Richard Norcross.
- 1653, Feb. [Jeremiah] Norcross.
- 1658, May. Simon Stone, Jr.
Samuel Stratton.
- 1654, May. Joseph Child.
- 1656, May. John Chadwick.
- 1657, May. Justinian Holden.
Anthony Beers.
- 1660, May. Hugh Clarke.
Henry Spring.
- 1668, May. Robert Harrington.
Nathaniel Holland.
(?) Daniel Pearse.
Lawrence Waters.
- 1665, May. Isaac Sternes, Jr.
John Stone.
John Grout.
- 1666, May. John Benjamin, Jr.
Thomas Fitch.
Henry Dow (Jr.)
- 1668, April. John Benjamin (probably a re-
petition).
Nathaniel Coolidge.
Jonathan Whitney.
Jonathan Browne.
Benjamin Bullard (then of Mead-
field).
Thomas Philbrick (then of Hamp-
ton).
- 1669, May. John Morse (?) of Groton.
Mr. John Sherman.
John Prescott (then of Lancaster).
- 1670, Oct. John Warren.
- 1671, May. John Barnard.
Samuel Livermore.
John Bright.
- 1672, May. Nathan Fiske (Jr.)
John Morse.
- 1678, Oct. (?) Stephen Cooke (then of Mendon).
- 1674, May. Gerahom Flagg (then of Woburn).
- 1678, May. Obadiah Perry (then of Billerica).
- 1679, Oct. John Marrion (then of Camb.),
see Eddy, pp. 208 and 755.
- 1682, Oct. John Flagg.
Abraham Gale.
Nathaniel Barsham.
William Bond.
Samuel Jennison.
- 1688, Feb. Mr. Samuel Parris (then of
Boston).
Theophilus Rhodes (then of Bos-
ton).
- 1684, May. John Whitney (then of Rox.)
- 1685, May. Uriah Clark (then of Box.)
- 1686, Mar. Lt. William Bond (Jr.)
Ebenezer Prout.
Abiah Sherman.
Caleb Church.
Samuel Eddy.
- 1690, Mar. Nicholas Wyeth.
Thomas Rider.
Eliexer Flagg (then of Concord).
John Tarbell (then of Salem Vil-
lage).
John Mason (then of New Camb.)
Ebenezer Stone (then of New
Camb.)
Stephen Cooke (of New Camb.)

April, Josiah Jones.
 John Livermore (Jr.)
 Thomas Woolson.
 Joseph Garfield.
 Josiah Treadway.
 John Woodward.
 Benjamin Wellington.
 John Bond.
 John Fiske.
 Joseph Harrington.
 Thomas Hammond.
 Michael Barstow.
 Joseph Peirce, Sen.
 John Bigelow, Sen.
 (?) John Wright.
 Daniel Harrington.
 Roger Wellington.
 William Shattuck.
 John Chinery.
 John Parkhurst.
 Nathaniel Bright.
 Samuel Hager.
 Palsgrave Wellington.
 Thomas Harrington.
 Nathaniel Bond.

John Kemball.
 Jonathan Smith.
 Mr. John Bisco.
 Mr. William Goddard.
 Samuel Thatchcr, Jr.
 John Bacon.
 Thomas Whitney.
 Richard Child, Jr.
 Benjamin Peirce.
 Joseph Underwood.
 (?) Thomas Kidder.
 Richard Cutting, Sen.
 Henry Spring, Jr.
 Jonathan Stimson.
 Samuel Bigelow.
 Benjamin Flagg.
 Benjamin Garfield.
 Richard Child.
 Daniel Warren.
 John Stearns (then of Billerica).
 May. Joseph Mason.
 John Warren, Jr.
 Thomas Straite.
 Samuel Bigelow.

ALLOTMENTS OF LAND, POSSESSIONS, &c.

§ 80. In early deeds, inventories, &c., there is a very frequent reference to several kinds or classes of lots, named generally in reference to some grant or allotment of lands; and such information concerning them as we have obtained, is here presented. It is derived chiefly from several schedules of grants and summaries of possessions contained in the early records. Of the earliest grants, called the Small Lots, there is no schedule, and the information respecting them is derived from the summaries of grants and possessions. The same may be said in regard to the marsh lands.

§ 81. 1. *Homestalls and home-lots.* These were collectively called the *Small Lots*, and they comprised, or rather were scattered over, nearly the whole of the present territory of Watertown. There were within these limits a few tracts of land, of uncertain or unascertained extent and dimensions, called Commons, devoted to the common use or benefit. There was the meeting-house lot of 40 acres, sometimes called the *Meeting-house Common*. Neither its situation, boundaries, nor dimensions are mentioned in the records; but it is pretty clearly inferred, from a collation of the references in the descriptions of grants and possessions, that it was situated between School St. on the West; Belmont St. on the North, and Mount Auburn St. on the S. East. "Fifteen acres of upland upon the Meeting-house Common were granted to" Rev. George Phillips. Rev. John Sherman, was allowed to take the wood from a part of it. A part of it was ordered to be sold in 1667 to defray the expense of rebuilding the Mill Bridge. *Pequusset Common* is the one most frequently mentioned in the records, and it is the one afterwards sometimes called *King's Common*. It was bounded N. by Cambridge Line; W. by the Great Dividends; S. and E. by the Small Lots. *Pequusset Common* was distinct from *Pequusset Meadow*. The latter was a narrow strip of land, a little distance east of Lexington Street, and running south from that Common towards Belmont Street. This meadow was granted in small lots to several proprietors, before the order was passed (May 21, 1638), for appropriating *Pequusset Common* to the general use. [See p. 996.] The common on the west side of the Great Pond was probably in Waltham. Other lots were granted to aid objects of general interest, viz., the wear and the mill. A small lot on the river was reserved for a public landing.

§ 82. There were small tracts of *marsh* on the border of Charles River, of which there is no schedule of the grantees or proprietors, but they are mentioned in the summaries of grants and possessions. They bore a very high price in proportion to that of any other land, as may be seen in inventories; but they are not mentioned in the valuations of land for the purpose of assessments. Most of them were probably disposed of at, or very soon after, the first planting of the town. There were, however, instances of grants of marsh land as late as 1635, as in the case of Mr. William Paine, who embarked for New England in that year. The town retained for a long time, in various parts of it, several parcels of land, usually called "common land," when mentioned as a boundary, yet probably not devoted to general use, like the commons, already mentioned. Some of them were retained until after the incorporation of Waltham.

§ 83. It does not, I think, appear, either in the colonial or town records, by what tenure or on what terms the freemen of the town held the lands, or were authorized to grant them to the townsmen. With the few following exceptions of grants made by the Court, they appear to have been all granted and allotted by the freemen of the town; and they made no grants, beside the Small Lots, until after the civil affairs of the town began to be "ordered" by a board of selectmen, in 1634. In Nov., 1632, the Court granted to Mr. George Phillips 30 acres of land "up Charles River, on the south side, beginning at a creek a little higher than the pines, and so upwards towards the wear." This is probably the 30 A. lot of meadow, which in the list of Mr. Phillips's grants, is described as bounded "the West with the river, the S. E. [S. and E.] by Cambridge Line." We should suppose, from the description of the grant in the colonial records, that the lot was nearly opposite the U. S. Arsenal, and that it was within the limits soon afterwards assigned to Cambridge. It is not easy to reconcile the two descriptions. [See sections 30 and 31.] On the 1st of April, 1634, the Court granted Mr. John Oldham 500 acres of land, "lying near Mount Feake, on the Northwest of Charles River." [See pp. 382 and 861.] This grant was made before the western boundary of Watertown was determined by the Court, and before any grants had been made by the freemen of the town, besides the small lots. On March 3d, 1635-6, at the same time, and in the same order that determined the western boundary of the town, the Court "agreed that Sir Richard Saltonstall shall have one hundred acres of meadow, to be set out indifferently by John Pratt and William Rescue." This, also, was a few months before any grants had been made besides the small lots. In the schedule of possessions made a few years afterwards, this lot is described as "remote meadow, bounded with the farm land." It was contiguous to the farm of 200 acres, and to the 100 A. lot in the Great Dividends, both not long afterwards granted to him by the freemen of the town. The foregoing three grants appear to be the only ones made by the Court within the limits of the town, and none was thus made after the western boundary was determined.

§ 84. There was an early map or plan of Watertown in the possession of the late Abner Sanderson, Esq., of Waltham. It was lent to a gentleman engaged in historical investigations, and unfortunately destroyed by a conflagration in Boston, in 1825, and no copy of it left. It was probably made by Abraham Browne, as it was done in 1640, while he was the town surveyor. This loss leaves it very difficult to determine the exact positions, where some of the first planters settled. In order to do this, it would be necessary to construct a plan of the town from the schedules of possessions. These give the number of acres in each lot with its surroundings; but their dimensions are not given, and it is evident that they were very irregular. According to the descriptions, the roads and the boundaries of lots nearly all ran parallel with the lines of latitude and longitude, yet, these seem to be the only directions in which they did not run. Some highway, road, or lane, is generally given as a boundary, but it is seldom named, and when named, not always clearly identified at this time; for, since that time, other roads have been laid out, and

some of the old ones vacated or changed. In laying out the lots and roads, the surveyor seems to have made no use of chain or compass.

§ 85. It is probable that, of the homestalls and homelots, allotted to the first planters, few or none exceeded 16 A. They varied from this to one acre, and their average was probably about 5 or 6 Acres. In the schedules of possessions there are several much larger homestalls, a few of which were grants; but it is very doubtful whether any of them were made at first. William Jennison had a homestall of 50 A. granted him; but, as in the case of Abraham Browne, John Warren, Isaac Sterne, Ephraim Child, W. Hammond, and others, he had at first a smaller lot granted him nearer to the river, and the large lot was probably a subsequent grant. It is certain that most of the homestalls exceeding 16 A. were not grants to the possessors, and that very few of the holders of large homestalls were first planters. The records show that, in some instances, they were acquired by purchase, and made up of several small lots, obtained of grantees, who migrated early to other plantations; as in the case of Jeremiah Norcross, whose homestall of 26 A. was composed of 4 lots, purchased of different persons. John Benjamin, who moved from New Town to Watertown about 1637, had a homestall of 60 A., probably obtained and made up in the same manner, as no part of it was granted to him. In some instances they were obtained partly by grant and partly by purchase, as in the case of Simon Stone, who had a homestall of 50 A., of which only 12 A. were granted, and the rest purchased of several different persons. The diminutive size and great number of the small lots led to frequent early changes in proprietorship, and this circumstance enhances very much the difficulty, already referred to, of determining the spots, where the primitive settlers first planted.*

§ 86. 2d. *The Great Dividends.* After the small lots, the earliest general grant of lands by the freemen was that of the *Great Dividends*, dated "July 25, 1636." "A grant of the Great Dividends [allotted] to the freemen [and] to all the Townsmen then inhabiting, being 120 in number. The land being divided into four divisions, every division being 160 rods in breadth,—beginning next to the small lots, and bounded with Cambridge Line on the North side, and with the Plowlands on the South. To be laid out successively one after another (all the meadows and cartways excepted), for them to enclose or feed in common." These four divisions were sometimes called the Squadrons, and the lines dividing them, the Squadron lines. These divisions are said "to begin next to the small lots," but it is difficult to determine this line exactly. Pequusset Meadow is described as bounded on the North by Cambridge Line, and on the West by the Great Dividends. It is conjectured that the Dividends began not far from the present boundary between Watertown and Waltham, and that for some distance these were bounded by the road (now Warren St.), which was the western boundary of the Town Plot.

The following are the names of the grantees, with the number of the lot and the number of acres. The dividends were numbered from the south 1, 2, 3, 4; the 4th being bounded N. by Cambridge Line. Many of the lots changed owners before 1644, and the name of the purchaser follows that of the grantee, in these tables.

§ 87. *The First Great Dividend*, beginning at the small lots at the East, was bounded on the South by the Beaver Brook Plowlands; running W. N. W. as follows:

- | | |
|---|--|
| <p>1. John Coolidge, 80 A., 12 A. sold to John Page.</p> <p>2. Edmund Sherman, 50 A. N. Busby.</p> <p>3. John Tucker, 25 A. John Woolcot; by his wid. to Edmund White.</p> <p>4. Isaac Mixer, 30 A.</p> | <p>5. Robert Veazy, 20 A., probably Geo. Woodward, after he m. Veazy's wid.</p> <p>6. Hugh Mason, 80 A. John Stowers. 6 A. to R. Veazy.</p> <p>7. John Stowers, 30 A.</p> <p>8. Robert Jennison, 20 A. John Stowers.</p> |
|---|--|

* Since this paragraph was written, notwithstanding the discouragement presented, we have succeeded in determining the localities, or relative position, of a great portion of the homestalls, as originally granted. We hope to have the results of this investigation sufficiently matured to be presented in Appendix H†.

- | | |
|--|--|
| <ul style="list-style-type: none"> 9. John Vahan, 20 A. T. Hawkins. 10. Richard Beers, 25 A. 11. William Paine, 70 A., J. Livermore, bequeathed to his son, N. Livermore. 12. Thomas Hastings, 25 A. 13. John Simpson, 80 A. Geo. Parkhurst, by him sold to T. Arnold, and by him sold to Geo. Parkhurst, Jr. 14. Robert Betts, 20 A. 15. Henry Dengaine, 20 A. John Bigelow. 16. John Rose, 20 A. Thomas Flagg. 17. John Kingsbury, 40 A. 18. Gregory Stone, 40. Thomas Boylston. 19. Bryan Pendleton, 70 A. P. Noyes. | <ul style="list-style-type: none"> 20. John Browne, 80 A. Abraham Browne. 21. John Dwight, 80 A. David Fiske. 22. John Barnard, 60 A. 23. William Knapp, 80 A. 24. Daniel Peirce, 25 A. 25. John Hayward, 50 A. 26. Edmund Lewis, 80 A., sold by his wid., of Lynn, to William Page. 27. Geo. Richardson, 25 A. John Traine. 28. James Cutler, 25 A. 29. John Griggs, 25 A. John Prescott. 30. Henry Goldstone, 80 A. John Stowers, 40 A., and Rt. Jennison, 20 A. 31. John Cutting, 60 A. |
|--|--|

§ 88. 2d Great Dividend, beginning at the Small Lots, and bounded on the south by the Squadron Line, separating it from the First Great Dividend.

- | | |
|---|--|
| <ul style="list-style-type: none"> 1. John Eaton, 40 A. 2. Edward Garfield, 80 A. 3. John Smith, Sen., 85 A. John Page. 4. Robert Daniel, 35 A. 5. Edward Goffe, 60 A. John Clough, 25 A. Hugh Mason, 85 A. 6. Thomas Mason, 20 A. Jere. Norcross. 7. Simon Stone, 70 A. John Biscoe. 8. Ephraim Child, 60 A. 9. Charles Chadwick, 85 A. 10. Robert Feake, 80 A. John Benjamin. 11. Abram Shaw, 70 A. J. Woolcot, by his wid. to Edmund White. 12. Samuel Hosier, 85 A. 13. Robert Lockwood, 85 A. B. Pendleton, in 1646. 14. Henry Cuttris, 20 A. 15. Samuel [Wm.] Swaine, 60 A. J. Biscoe. | <ul style="list-style-type: none"> 16. John Firmin, 60 A., by his heirs to B. Farr; and by him to Rd. Beers. 17. Nicholas Knapp, 80 A., sold to B. Pendleton, 1646. 18. William Barsham, 80 A. 19. Robert Tucke, 80 A. Jere. Norcross. 20. John Batchelor, 85 A. J. Norcross. 21. John Smith, Jr., 80 A. Rd. Woodward. 22. Abraham Browne, 50 A. John Coolidge. 23. William Bridges, 35 A. J. Brabrook. 24. Richard Browne, 50 A. John Sherman. 25. Gregory Taylor, 85 A. 26. Thomas Brooks, 20 A. S. Saltonstall. 27. John Gay, 85 A. Samuel Freeman. 28. George Phillips, 80 A. 29. Matthew Hitchcock, 20 A. D. Patrick. 30. George Munnings, 80 A. J. Sherman, (?) bounded West by Sudbury line. |
|---|--|

§ 89. 3d Great Dividend, beginning at the Small Lots and separated by the Squadron Line from the 2d Great Dividend on the south.

- | | |
|--|---|
| <ul style="list-style-type: none"> 1. Thomas Arnold, 80 A. G. Parkhurst, 1655; in 1663, with dwelling-house and 80 A., sold by T. Tarball to Thomas Hastings. 2. Thomas Smith, 20 A. Charles Stearns. 3. Henry Kembal, 35 A. 4. Edward Dix, 80 A. 5. Nathaniel Bowman, 85 A. 6. Edward Lamb, 25 A., sold to Charles Stearns, in 1648. 7. Thomas Rogers, 80 A. John Sherman. 8. Benjamin Crispe, 20 A. T. Boyden, in 1668. 9. Martin Underwood, 25 A. 10. Lawrence Waters, 25 A. 11. Emanuel White, 25 A. John Eddy. 12. Thomas Mayhew, 80 A., sold by John Page to Thomas Hastings, in 1663, for £21.5. 13. John Spring, 85 A. 14. William Swift, 40 A. John Knight. | <ul style="list-style-type: none"> 15. Edward How, 70 A. 16. John Whitney, 50 A. 17. John Ellet, 25 A. 18. Thomas Bartlett, 80 A. 19. Daniel Morse, 20 A. 20. Richard Woodward, 85 A. 21. John Loveran, 80 A. 22. Thomas Parish, 20 A. T. Wincoll. 23. Miles Nutt, 25 A. 24. John Winter, 25 A. 25. William Jennison, 60 A. T. Ruck, by him sold to Isaac Sterne. 26. Joseph Morse, 25 A. 27. John Finch, 80 A. 28. William Palmer, 80 A. J. Wincoll, 15 A., and to N. Theale, 15 A. 29. Esther Pickeram, 25 A., by Joshua Stubbs, sold to Joseph Underwood, in 1654. 30. Sir Richard Saltonstall, 100 A.; son Henry. |
|--|---|

§ 90. 4th. Great Dividend, beginning at the Small Lots, and separated by the Squadron Line from the 3d Great Dividend, and bounded N. by Camb. line.

- | | |
|---|---|
| <ol style="list-style-type: none"> 1. Simon Eire, 60 A. 2. Roger Wellington, 20 A. 3. William Baker, 25 A. Joseph Bemis. 4. Leonard Chester, 60 A. John Biscoe. 5. William Hammond, 40 A. 6. Isaac Cummins, 35 A. J. Lawrence. 7. Philip Tabor, 30 A. Edmund White. 8. Richard Sawtel, 25 A. 9. John Page, 50 A. Michael Barstow. 10. John Eddy, 50 A. 11. John Livermore, 25 A. Miles Nutt. 12. John Doggett, 30 A. Richard Wait. 13. Edmund James, 40 A. Thos. Andrews. 14. Robert Abbot, 35 A. R. Wellington. 15. Isaac Sterne, 50 A. | <ol style="list-style-type: none"> 16. Thos. Philbrick, 35 A. in 1646, sold to I. Sterne. 17. John [? Wm.] Gutteridge, 25 A. 18. John Lawrence, 30 A. Edm. White. 19. Frances Onge, 30 A. Justinian Holden. 20. Henry Bright, 30 A. 21. Garret Church, 20 A. 22. John Tomson, 25 A. Wm. Clark. 23. Christopher Grant, 25 A. 24. Barnabas Windes, 35 A. J. Brabrook. 25. Thomas Wincoll, 25 A. John Warren. 26. John Warren, 30 A. 27. John Gosse, 35 A. J. Wincoll, 15 A. 28. Richard Kimball, 50 A.; son Henry. (?) N. Theale, 15. 29. Thomas Cakebread, 50 A. John Grout. |
|---|---|

§ 91. *3d Beaver Brook Plowlands.* The next general grant of land was that of the Beaver Brook Plowland, partly meadow, and partly upland, the record of which is as follows: "1636 [36-7], Feb. 28. A grant of plowlands at Beaver Brook Plains, divided and lotted out by the freemen to all the Townsmen then inhabiting, being 106 in number, allowing one acre for a person, and likewise for cattle valued at £20 the head; beginning next the Small Lots beyond the wear, and bounded with the Great [Dividend] Lots on the north side, and Charles River on the south, divided by a cartway in the midst; the first lot to begin next the river, the second on the north side of the cartway, and to be laid out successively until the lots are ended." It is probable that the grant was made in Sept., 1636, when a committee was appointed to "devise to every man his propriety of Meadow and Upland that is plowable, and the rest to lie common;" and that the date of the record (Feb. 28, 1636-7), was the time when the allotments and schedules were completed. The lands then granted amounted to 741 acres, of which about 235 A. were at the east of Beaver Brook, and were designated, "lots in the Hither Plain," sometimes called the Little Plain. The rest of the lots were situated west of Beaver Brook, and were called the "lots in the Further Plain," sometimes called the Great Plain.

§ 92. The lots in the Hither Plain began at the *Driftway* (now called Gore St.), and a line continued southwardly, from the S. end of the Driftway, to the river. These lots were arranged or plotted in two series or ranges. One of them was bounded on the south by the river, and on the north by the cartway betwixt lots [Pleasant St.]; and the lots in it were designated by the odd numbers, 1, 3, 5, &c., to 43 or 45, and each lot extended from the cartway to the river. The other series, beginning at the Driftway, were bounded on the south by the cartway betwixt lots, and on the north by the highway, afterwards long known as the Sudbury Road, now called Main Street. Each lot extended from one of these streets to the other, and they were designated by the even numbers, 2, 4, 6, &c., to 36. These two ranges did not extend so as to be contiguous to Beaver Brook. A small strip of land on its eastern border was retained as town or common land.

§ 93. Although the 40 A. lot of Mr. Phillips is placed at the head of the schedule of these grants, it is evident it was within the limits of the Small Lots, and did not properly belong to the Beaver Brook plowland grants, from which it was separated by the Driftway. It belonged to "the small lots beyond the wear," and the grant was probably made to him, at the same time that others, in the immediate neighborhood and contiguous to it, were granted to Sir Richard Saltonstall, Edward How, and Abraham Browne. This improper insertion of the name of Mr. Phillips, will account in part for the discrepancy between the number of grants said to have been made [106] and the number of names on the list [108]. The same thing occurred in regard to the list and allotments of the Town Plot. The name of Mr. Phillips is the first on the list, although his lot was not in the Town Plot, and it was probably granted to him some time before the allotments of that plot.

§ 94. In the grant of the Beaver Brook Plowlands, they are described as "beginning next the small lots beyond the wear." The following is the order of the lots, with the names of the grantees, between Sudbury Road on the north and the way betwixt lots (Pleasant St.) on the south, beginning at the way to the Little Plain (Howard St.). 1st. The homestall and adjoining homelots of Abraham Browne, 40 A. 2d. A lot of 12 A. granted to Edward How, and by his heirs sold to Robert Harrington, from whom it passed to his son Edward, and after probably to his grandson Edward. 3d. A 40 A. lot granted to Rev. George Phillips, and by his heirs sold to Edward Garfield, about 1650. This was bounded on the west by the Driftway, which was the boundary between the Small Lots and the Beaver Brook Plowlands. In the Inventory of E. Garfield, this lot is described as "on the Little Plain, near Sudbury Road," and it was then (1672), appraised at £60. In late times it became the elegant residence of Governor Gore, and it now belongs to J. S. Copley Greene, Esq. Immediately south of this lot of Mr. Phillips, and separated from it by the cartway betwixt lots, was a 20 A. lot of plowland, granted to Sir R. Saltonstall. It was bounded on the west by the first lot (John Whitney's) in the Beaver Brook Plowlands, and his son Samuel afterwards sold it to Whitney. As this lot was bounded W. by the land of Whitney, it appears that the Driftway did not extend to the river. Situated E. and S. E. of this lot of Sir Richard, between the river and Pleasant Street, were lots belonging to John Knight, Edward How, Joseph Morse, Richard Woodward, and Abraham Browne.

§ 95. The lots in the Further Plain (in later times called Waltham Plain), beginning at Beaver Brook, were bounded on the south by Charles River, and on the N. by the Great Dividends, or "common land." They were plotted in two ranges, like those in the Hither Plain, and separated from each other by Sudbury Road, now called Main Street. The range next the river were designated by the odd numbers, continued from the Hither Plain, beginning No. 45, and each lot extended from the river to Sudbury Road. The other range, on the north side of the highway, were designated by the even numbers, continued from the Hither Plain, and each lot extended from Sudbury Road to Great Dividend lands.

The following table shows the names of the grantees in each of the four ranges, their order of arrangement, and the number of acres granted to each. Many of the lots changed proprietors before 1644, and the second name to a lot is that of the purchaser. The year, added in a few instances, shows that the sale took place at a later date than 1644.

The range of lots in the Hither Plain, next the river.

1. John Whitney, 10.	25. F. Onge, 6,	} T. Eire, 20.
3. Rd. Woodward, 6.	27. S. Eire, Sen., 18,	} S. Eire, Jr., 6.
John Griggs.*	29. Sir Richard Saltonstall, 30 A.,	E. Child,
5. C. Chadwick, 8.	28, and S. Eire, Jr. 2.	
9. H. Goldstone, 7.	31. N. Baker, 5; John Traine.	
11. John Tomson, 2; E. Child.	33. G. Munnings, 4; E. Garfield.	
13. J. Eddie, 7; E. Child.	35. N. Knapp, 6; B. Pendleton, 1646.	
15. B. Crispe, 3; J. Knight; T. Underwood.	37. John Ellet, 4; B. Pendleton, 1646.	
17. Edmund Sherman, 6; N. Busby.	39. John Eaton, 6; E. How.	
19. G. Taylor, 5; S. Eire, Sen.	41. W. Jennison, 10; E. Child.	
21. D. Patrick, 14; S. Eire, Sen.	43. S. Hosier, 5; E. Child.	
23. E. Child, 16.	45. (?) S. Freeman, 5. †	

* This name occurs in the schedule, but it seems to be superfluous in the numbering of the lots.

† Names with this mark are not in the original schedule, but these lots were grants, probably made soon after the date of the schedule.

The North range of lots in the Hither Plain.

- | | |
|---|--|
| <p>2. Thomas Hastings, 2.
 4. R. Betts, 1; (?) Edmund White.
 6. John Simson, 4; S. Eire, Jr.
 8. R. Veasey, 1.
 10. J. Smith, Sen., 4; S. Eire, Jr.
 12. S. Eire, Jr.; not a grantee.
 (1) { 14. W. Barsham, 3.
 W. Bridges, 5; (?) S. Eire, Jr.
 20. J. Coolidge, 5; A. Browne.</p> | <p>22. J. Morse, 2; E. Child.
 24. R. Lockwood, 6; R. Daniel; E. Garfield, 1651.
 26. *John Gay, 5; S. Freeman.
 28. H. Bright, Jr., 8; I. Mixer, 1658.
 30. R. Sawtel, 1.
 32. Francis Smith, 8; R. Woodward.
 34. J. Loveran, 20; B. Garfield, 1685.
 36. †E. Blois, 4; [See Sect. 148.]</p> |
|---|--|

The range of lots in the Further Plain, next to the river.

- | | |
|--|--|
| <p>45. John Goss ("Goffee"), 4, next to the Brook; sold to J. Stowers.
 N. Bowman, 7; J. Stowers, March 18, 1648-4; T. Hammond, 1650.
 R. Kemball, 12; J. Stowers.
 R. Browne, 9.
 J. Tucker, 8; W. Woolcott.
 E. Dix, 8.
 T. Hawkins, 2; J. Brabrook.
 J. Cutler, 8; J. Brabrook.
 Daniel Peirce, 1; J. Prescott.
 J. Kingsbury, 6.
 I. Sterne, 11.
 M. Nutt, 8.
 T. Philbrick, 9; I. Sterne, Jan., 1645-6.
 Robert Daniel, 8.
 E. How, 24.
 T. Mayhew, 30.</p> | <p>J. Firmin, 9.
 E. Mason, 1.
 J. Bachelor, 6. } J. Norcross.
 R. Tucke, 5.
 J. Knight, 5.
 E. Lewis, 5; Wm. Page, 1652.
 Wm. Swift, 5; John Knight.
 E. Lamb, 8; C. Stearns.
 R. Wellington, 2.
 John Nicarson (Nichols), 2; M. Ives.
 E. Pickeram, 6; J. Stubbs, 1646.
 J. Warner, 7; M. Barstow.
 E. Garfield, 7.
 H. Mason, 8.
 T. Bartlett, 2.
 L. Waters, 4.
 G. Church, 8.</p> |
|--|--|

The range of lots in the Further Plain, N. of Sudbury Road; next the Great Dividends; beginning at Beaver Brook.

- | | |
|---|--|
| <p>John Page, 13; J. Bisco.
 T. Wincoll, 6.
 B. Pendleton, 12; P. Noyes.
 J. Lawrence, 8; Edm. White.
 T. Cakebread, 8; J. Grout.
 H. Cuttris, 1.
 J. Bernard, 10.
 T. Brooks, 4; Saml. Saltonstall.
 G. Stone, 10; T. Boylston.
 John Cutting, 10; J. Stowers.
 B. Windes, 6; R. Benjamin.
 R. Feake, 24; John Benjamin.
 T. Smith, 2; T. Flagg, 1659.
 J. Rose, 3; S. Onge; (?) H. Dow.
 J. Hayward, 7.
 Simon Stone, 14.
 Isaac Mixer, 4.
 H. Dengaine, 1; T. Andrews.
 E. James, 5; T. Andrews.</p> | <p>J. Warren, 13.
 Wm. Knapp, Sen., 7.
 H. Kemball, Sen., 6.
 (?) W. Palmer, 1; (?) J. Knight.)
 J. Finch, 4; J. Wincoll.
 J. Winter, 8.
 C. Grant, 8; John Harrington, 1688.
 (?) J. Smith, Jr., 1.
 J. Dwight, 7; D. Fiske.
 J. Spring, 6.
 Em. White, 3; (?) E. Child.
 W. Gutterig, 8; C. Grant; John Harrington, 1688.
 T. Rogers, 5; J. Sherman.
 John Doggett, 6; (?) R. Wait.
 M. Underwood, 2.
 W. Paine, 24.
 (?) A. Shaw, 10; W. Woolcot; Edm. White.</p> |
|---|--|

§ 96. 4th. *Remote or the West Pine Meadows.* The next general grant of lands was made only a few months after that of the Beaver Brook Plowlands, and the following is the record of it. "1687, June, 26. A grant of the Remote or West Pine Meadow, divided and lotted out to all the Townsmen then inhabiting, being

* In the list of S. Freeman's possessions, this lot is included as a grant. This is probably a mistake, unless Gay had relinquished it to the town.

114 in number, allowing one acre for a person, and likewise for cattle, valued at 20lb. the head, beginning next the Playne Meadow, and to go on until the lots are ended. Granted to Robert Feake, forty acres; to Edward How, twenty-four acres." By comparing this order with that granting the Beaver Brook Plowlands, it will be seen that in each of them the same rule was adopted as to the quantity of land allotted to each individual. The lots were numbered, with the number of acres in each, with the exception of those of R. Feake, and E. How, which seem to have been distinct from the others. These meadows were probably in the southern and southeastern part of Weston; but their location and dimensions have not been ascertained, nor has it been discovered that there was any regular order or series in the arrangement of the lots.

§ 97. *5th. Town Plot, Township, Town Lots.* July 30, 1635, it was "Agreed, by the consent of the freemen, that two hundred acres of upland near the Mill shall be reserved as most convenient to make a township." This was a year before any of the general grants of land were made; but the records do not show that there was any order for the survey or allotment of this reservation until Ap. 9, 1638, when it was ordered that the Selectmen "shall have power to give out the land upon the Town Plots to several persons, according to their discretions." At a town meeting, two weeks later (Ap. 23), it was "Ordered, that those freemen of the congregation [to whom these lots were assigned] shall build and dwell upon their lots at the town plot, and not to alienate them by selling or exchanging them to any foreigner, but to the freemen of the congregation; it being our real intent to sit down there close together, and, therefore, these lots were granted to those freemen, that inhabited most remote from the meeting-house, and dwell most scattered." [See p. 996.] At the date of this order, it is probable that the meeting-house was at the east of Mount Auburn.

§ 98. There has been much perplexity in ascertaining, or even conjecturing, where this reservation for a town plot was located; for there is nothing in the town records indicating its locality, boundaries, or dimensions. We have, however, after a careful collation and analysis of circumstantial data, arrived at a conclusion, which is satisfactory, if not clearly demonstrable, viz.: that it was that tract of land, bounded E. by Lexington St., S. by Sudbury Road (Main St.), N. by Belmont St., and W. by that continuation of Belmont St. (a part of which is now called Warren St.), where it turns to the south until it intersects Main Street. A road ran E. and W. through the middle of it, now called Warren Street. There was one range of lots on the south side of Belmont St.; one on the north, and another on the south side of Warren St., and a fourth range on the N. side of Main St., (Sudbury Road). As no penalty was attached to the order, requiring the grantees to build and settle on their lots, and forbidding their alienation to any except freemen, the order appears to have been entirely disregarded, as it is clear that very few, if any, of the grantees ever resided on them. The greatest part of the lots very soon passed into other hands, and in many instances to those who were never admitted freemen, or not until a long time afterwards.

§ 99. In the volume of town records containing the other schedules of possessions, is the following list of the grantees of the town plot. The name and lot of Rev. George Phillips is at the head of the list, although, as in the schedule of the Beaver Brook Plowlands [Sect. 93], this lot was not in the town plot, but on the east side of Lexington Street. At least three lots (6 A. to John Whitney, Sen.; 6 A. to John Sherman; and 8 A. to T. Arnold), were granted in this plot, after the following list was recorded. "1638, Ap. 9. A Division of land at the Town Plot, No. 40. George Phillips, 12 Acres; Robert Feake, 9 A.; Richard Browne, 9 A.; Daniel Patrick, 9 A.; Winifred Woolcott, 6 A.; John Firmin, 6 A.; Samuel Hosier, 6 A.; Simon Stone, 6 A.; John Smith, 6 A.; Simon Eire, 6 A.; Edmund James, 6 A.; John Doggett, 6 A.; Nicholas Busby, 6 A.; Richard Beers, 6 A.; John Coolidge, 6 A.; Edmund Lewis, 6 A.; John Stowers, 6 A.; Barnaby Windes, 6 A.; Hugh

Mason, 6 A.; Frances Onge, 6 A.; Samuel Freeman, 6 A.; Henry Bright, Jr., 6 A.; John Nicarson, 6 A.; David Fiske, 6 A.; Henry Dow, 6 A.; Gregory Taylor, 6 A.; John Tomson, 6 A.; Thomas Hastings, 6 A.; Daniel Pierce, 6 A.; Charles Chadwick, 6 A.; Edward How, 9 A.; John Eaton, 3 A.; John Smith, Jr., 3 A.; Isaac Mixer, 6 A.; Edmund Blois, 6 A.; John Baker, 3 A.; Abraham Browne, 6 A.; William Potter, 4 A.; Thomas Philbrick, 3 A.; Thomas Carter, — A." The reservation ordered for a township was to contain 200 A.; but the above grants, deducting that of Mr. Phillips, amounted to 238 Acres. To this, are to be added the lots subsequently granted to Whitney, Sherman, and Arnold.

§ 100. 6th. *Lieu of Township Lots*, or lots *beyond the Further Plain*. On the 17th July, 1638, three months after the allotment of the Township Lots, it was by the freemen "Ordered, that all those *freemen* that have no lots at the Township, shall have 12 Acre lots beyond Beaver Plain, and all other *townsmen* shall have 6 Acre lots in [(?) beyond] the said Plain." The lots thus granted, are those often mentioned in inventories and lists of possessions, as *Lieu of Township* land. They were situated at the west of Waltham [Beaver] Plain, immediately south of the Great Dividends, and extended westward beyond Stony Brook. The names of at least 67 grantees are found in the records, and their lots amounted to about 800 acres. The lots were all numbered, but the records do not show that there was any regular order or series in the arrangement of them.

§ 101. On the same day (July 17, 1638), that the *Lieu of Township* land was granted, it was "Ordered, that all the land lying beyond the Plowland and the lots granted in lieu of the township, having the Great Dividends on the one [North] side, Charles River and Dedham bounds on the other [south] side, and the Farm lands at the farther end [west side] of it, shall be for a common for cattle, to the use of the freemen of the town and their heirs forever, and not to be alienated without the consent of every freeman and their heirs forever." This was called the *Freemen's Common*. Notwithstanding this attempt at absolute perpetuity, on the 27th Nov., 1639, the freemen granted this tract conditionally to the Farms. [See Section 81.]

§ 102. 7th. *The Farms, or Farm Lands*. The first notice in the records of the Farm lands is in the preceding order, concerning the *Freemen's Common*. Three months afterwards (Oct. 14, 1638), it was "Ordered, that the Farms granted shall begin at the nearest meadow to Dedham Line, beyond the line that runneth at the end of the Great Dividends, parallel to the line at the end of the town bounds [Sudbury Line], and so to go on successively from Dedham bounds, in order as they are given out, as they which are deputed to lay them out shall see good, and appoint the proportion of meadow, being twenty acres to one hundred and fifty acres of upland." At the same time it was "Ordered, that Daniel Patrick, Abraham Browne, John Stowers, Edmund Lewis, and Simon Eire, or the major part of them, shall lay out the Farms as they are ordered." The next year (Nov. 27, 1639), it was "Ordered, that if the Land in view for Farms shall not suffice to accommodate the rest of the townsmen that are behind, that then they shall have their farms out of the *Freemen's Common*, upon the same condition that the rest have theirs."

§ 103. In the Files of the County Court, is the following document. The summaries in brackets, here inserted, are not in the original; and a name in brackets, following that of a grantee, shows who had become proprietor of the lot previous to 1644. This order for allotting the Farms by 10 in a division, and with the lots so numbered, is by no means lucid, and is, indeed, enigmatical. "1642, 3 m. 10 d. Ordered [by the town], that all the townsmen that had not farms laid out formerly, shall take them by 10 in a division, and to cast lots for the several divisions, allowing 13 Acres of upland to every head of persons or estates."

"1st Lot, or Division.		No. of the Lot.	Acres.
No. of the lot.			
48. George Richardson,	39	69. George Munning,	78
[John Traine.]		12. Nicholas Guy,	64
92. John Barnard,	287		[10 farms=986 A.]
21. William Potter,	54	<i>6th Lot, or Division.</i>	
63. William Knapp,	98	3. Thos. Arnold,	97
104. Rd. Beers,	49	74. Esther Pickeram,	99
87. Garret Church,	53	1. John Finch,	91
58. Chr. Grant,	117	[Thos. Wincoll.]	
55. Geo. Parkhurst,	55	41. John Ellet,	78
28. William Cutting (Gutterig),	91	84. Lawrence Waters,	105
49. William Clarke,	58	99. Edward Lamb,	65
	[10 farms=896 A.]	85. Isaac Mixer,	92
<i>2d Lot, or Division.</i>		26. Nathl. Bowman,	88
69. Simon Stone,	158	52. Joseph Morse,	73
[Samuel Saltonstall.]		22. William Eaton,	80
108. Charles Chadwick,	99		[10 farms=863 A.]
85. Gregory Taylor,	75	<i>7th Lot, or Division.</i>	
97. John Smith,	78	24. John "Goff" [Goss],	49
56. Wm. Barsham,	88	96. Saml. Saltonstall,	157
75. Samuel Hosier,	39	66. R. Wellington,	67
90. Nich's Knapp,	117	4. Richard Wait,	60
47. Robt. Lockwood,	134	77. Wm. Bridgee,	77
9. David Fiske,	149	86. Henry Cuttris,	17
18. Martin Underwood,	48	78. Barnabas Windes,	110
	[10 farms=980 A.]	58. John Loveran,	150
<i>3d Lot, or Division.</i>		59. Justinian Holden,	40
27. Samuel Freeman,	121		[9 farms=727 A.]
7. Joseph Bennis,	44	<i>8th Lot, or Division.</i>	
2. John Peirce,	78	71. Winifred Woolcott,	188
20. Anthony Peirce,	86	88. John Knowles,	100
72. Nichs. Busby,	86	57. Thos. Carter,	92
68. Miles Ives,	78	19. John Knight,	270
15. Thos. Philbrick,	127	98. John Eddy,	120
33. John Warren,	162	84. Edm. Blois,	48
6. John [Isaac] Stearns,	259	82. Rd. Woodward,	125
25. John Winter,	34	71. John Spring,	71
	[10 farms=1070 A.]	81. Henry Kembal, Sen.,	105
<i>4th Lot, or Division.</i>		100. Miles Nutt,	51
38. John Bisco,	250		[10 farms=1160 A.]
98. Thos. Bartlett,	66	<i>9th Lot, or Division.</i>	
76. William Hammond,	165	101. William Jennison,	150
44. John Lawrence,	93	67. Rd. Browne,	150
28. Edwd. Dix,	105	91. Hugh Mason,	71
62. Timothy Hawkins,	64	79. Thos. Hastings,	71
16. Benjn. Crispe,	64	78. Ephm. Child,	150
29. Thomas Smith,	84	83. John Sherman,	171
60. James Cutler,	82	64. Rt. Jennison,	65
	[9 farms=978 A.]	18. John Prescott,	90
<i>5th Lot, or Division.</i>		46. John Coolidge,	119
17. H. Goldstone,	209	45. Thos. Wincoll,	144
89. Henry Bright,	125	14. Thos. Boylston,	73
80. Robert Veazey,	32	11. Rd. Sawtel,	67
102. Henry Dow,	97	65. Henry Greene,	67
54. John Clough,	91	94. Francis Smith,	181
89. Benjn. Bullard,	88	[Rd. Woodward.]	
40. Michael Barstow,	129		[14 farms=1519 A.]
86. John Simson,	78		[Total, 92 farms=7674 Acres.]
[Geo. Parkhurst.]			

"This is a true copy, taken out of a transcript of the Town Book of Watertown, this 7 (2), 1668, (signed), John Sherman. Confessed in Court, by Mr. John Sherman, 6 (2), 1669, Thomas Danforth."

§ 104. By examining this schedule, it will be found that there are the names of 92 grantees, while the highest number of a lot is 104, and that there are 12 or 13 numbers blank, or without a grantee's name. In one or two instances, the same number is attached to the lots of two grantees, probably, oversights in making the schedule, or in the copy of it. In the introduction to the schedule, mention is made of "farms laid out formerly," that is, previous to May, 1642. A range of lots, on the south side of the highway [? Sudbury Road], was laid out to the following persons, whose names are not in the preceding schedule. The 1st lot in the range, adjoining Sudbury Line, was that of Bryan Pendleton, by him sold to Peter Noyes, and very early purchased by George Munning. The next, adjoining it on the east, was that of Daniel Patrick; next, Simon Eire, 200 A.; next, John Stowers, 130 A.; next, Abraham Browne, 130 A.; next, John Whitney, 120 A.; next, Edward How, 200 A.; next, Jeremiah Norcross, 250 A.; next, Thomas Mayhew, 250 A. To these may be added the following names, not found in the preceding schedule, viz.; Sir Richard, 300 A., granted to him by the General Court, which farm passed to his son Henry; Edmund Lewis, 100 A.; Edward Garfield, 100 A. It will be perceived that the committee of Oct., 1638, to lay out the farm lands, was composed of persons here named, and not contained in the schedule, and, that during three years and a half after their appointment, they seem to have laid out few besides their own farms.

§ 105. It may be seen, in the order for the laying out the Great Dividends, that all the meadows within them were excepted. Among these were *Patch Meadow*, whose location has not been clearly ascertained; *Pond Meadow*, in the N. E. part of Waltham; *Rock Meadow*, on the borders of the upper part of Beaver Brook, and situated partly in Watertown [Waltham], and partly in Cambridge [W. Camb. and Lex.]; *West Meadow*, on the northern border of the town, adjoining Cambridge [Lex.], but the exact location not ascertained. Numerous proprietors of lots in these meadows are found in the schedules of possessions and inventories. Besides the Beaver Brook Plowlands, a considerable number of meadow lots on Beaver Brook were held by different persons. Perhaps, these were identical with Rock Meadow. Other meadows are mentioned, of which we know very little. *Chester Meadow*, was on Chester Brook, the outlet of Sherman's Pond. Edward Garfield, in his Will, mentions a "meadow further side of Chester Brook, called *Plane Meadow*," and in his Inventory, it is called *Chester Meadow*. *Pequusset Meadow* [See Section 81]. Several small tracts of meadow, not designated by distinct names, were situated among the Small Lots. *Cherry Meadow*, was probably on Cherry Brook, a W. branch of Stony Brook. *Crooked Meadow*, *Long Meadow*, *Slendergut Meadow*, &c.

§ 106. For much additional information respecting the allotment of lands; regulations for fencing and feeding in common; for surrounding the plowlands in common enclosures, &c., see the transcript of the original records, as printed, pp. 995 &c.

§ 107. There was much dissatisfaction among the Watertown people, with the early allotments of the Remote Meadows, the lands in lieu of township, and of the farm lands, which led to much contention and repeated surveys. Jan. 10, 1647-8, Mr. Bisco, Lieut. Mason, and Isaac Stearns, were appointed a committee "to determine the wrong in laying out the Remote Meadows;" and at the same time a committee of 7 (Lieut. Mason, John Coolidge, Dea. Hastings, Mr. Bisco, John Sherman, John Warren, and Mr. Pendleton), was appointed to consider the disputes "about lands in lieu of township." The dissatisfaction and contention continued many years, at least until 1668, and it was probably this state of affairs, that acquired for a considerable tract of land, in the S. W. part of Watertown, the name of "the land of contention," terms frequently occurring in deeds. About 1663,

this part of Watertown was again surveyed and plotted out by Capt. John Sherman, in order to be allotted to those to whom it was granted. It contained 1102 acres, including that covered by water, and was bounded on the south by Dedham ; west by Natick and Sudbury, otherwise by Watertown farm-land. There is in the county records a delineation of the outline of this tract, as surveyed, but not a plot of the farms within it.

SOIL, FORMATION OF THE LAND.

§ 108. For an account of the soil, and of the formation of the land, within the three precincts of Watertown, we must rely chiefly upon the descriptions of them by those who resided there, and were very competent observers.

§ 109. Rev. Dr. Francis, in his History of Watertown, says : "The soil of Watertown is in general remarkably good. A portion of the southeastern extremity of the town is sandy, poor, and barren ; but with this exception, the land is among the best and most productive in the Commonwealth. The soil consists for the most part, of black loam, having a substratum of hard earth, so that it suffers little comparatively from drought in the summer. There is [in 1830], very little woodland in the town, nearly all the land having been cleared and cultivated." We may infer, from the early records, printed in the preceding pages, and from the subsequent records, that it was not well wooded at the first settlement, as strict orders were passed very early to prevent the destruction of trees ; as trees, single or in small numbers, were sometimes granted or accepted as a compensation for debt or service, and individuals were sometimes permitted by a town order, to take dead trees on the common land. Townships are rarely found, especially in New England, where so very large a proportion of the land is well adapted to tillage, and where there is so very little broken or waste land, as in Watertown.

§ 110. There are few hills of any considerable elevation, and only two or three appear to be named in the early records. The first is *Strawberry Hill*, repeatedly mentioned in the early schedules of possessions. There has been much perplexity and uncertainty, as to its locality ; whether it was identical with Schoolhouse Hill, or was situated farther north, near the Cambridge Line, or a little west of Fresh Pond. It is stated, on page 47, on what then seemed to be sufficient grounds, that the 50 Acre homestall of Capt. Jennison, was situated on the northern side of Belmont Street, where J. P. Cushing, Esq., now resides. This homestall was bounded on the north by the lot of Thomas Philpot, which lot was bounded on the north by Strawberry Hill. In 1697, Mary, wid. of William Price, sold to Samuel Livermore her house and 12 acre lot, which was bounded N. E. by Cambridge Line, and west by Philpot's lot. Any evidence, that Philpot had more than one lot of land, had been sought in vain. We now suppose that, after the schedule of possessions was completed, in 1644, and before Philpot became insane, about 1646 or 7, he had purchased a second lot near Cambridge Line, upon which he built a house, and which the town held and rented to various persons, for more than 70 years ; that the lot between Jennison's homestall on the south, and Strawberry Hill on the north, was the one sold, in 1651, to John Clary, by order of the Court, to defray the expense of Philpot's imprisonment, and which Clary, in 1688, sold to William Bond, Esq., then proprietor of the Jennison homestall. This supposition is favored by the circumstance that, in the schedule of possessions, the Philpot lot at Strawberry Hill contained, by estimation, 10 acres, while the lot, so long rented by the town, contained between 3 and 4 acres. It now seems to be clearly ascertained, that Capt. Jennison's homestall, of 50 A., was on the north side of Mount Auburn Street [at first called Mill Street], between Common and School Streets, and that Strawberry Hill was identical with School-house Hill, afterwards called Meeting-house Hill. In

the Mid. Registry of Deeds, p. 383, is a deed, dated May 25, 1694, by Thomas Underwood and wife Mary, conveying to Nathaniel Fisk "land on the south side of Strawberry Hill (or the School-house Hill)," bounded east "by highway over the hill by the school-house." This seems to prove the identity of Strawberry and School-house Hills. It is the highest point of land in the town.

§ 111. *Whitney's Hill*, is supposed to be the same which has of late been called *White's Hill*. The homestall of John Whitney, of 16 A., bought of John Stickling, was situated east of it [see Whitney, 1 and 60]. Oct. 29, 1697, Joshua Whitney, then of Groton, sold this 16 A. homestall to Corp. [afterwards Dea.] Nathan Fiske, and it was then bounded on the N. by Joseph Sherman, and Henry Spring; E. by Thomas Bond; S. by Lieut. Jonas Bond; W. by N. Fiske. At an early date, John Whitney, Sen., and his sons, had become proprietors on the north and west sides of this hill. In 1644, the homestall of John Whitney, Jr., was on or near the spot where Mr. Charles Whitney now or lately resided, and he owned the lot in the Town Plot at the S. W. corner of Belmont and Lexington Streets. The meeting-house, built about 1695, where Mr. Angier was settled, was at the S. E. angle of the Belmont and Lexington Street cross-roads, and it was ordered to be built between wid. (Hannah) Stearns and Whitney's Hill, and was sometimes described as between the Pound and Whitney's Hill. The Pound was then at those cross-roads, where it was constructed about 1687. *Elbow Hill* is sometimes mentioned in the description of roads, and was probably nothing more than a declivity in Lexington Street, at first called the Concord Road. The highest point in Mount Auburn Cemetery is less than 100 feet above tide water, and before its present appropriation, this tract, or a part of it, was called Stone's Woods. It does not seem to have been deemed of sufficient height or importance to be designated or referred to in any of the records.

§ 112. A writer in the Mass. Hist. Coll., 2d Ser. III., in describing Waltham [the middle precinct of Watertown], says: "The land in the south part of the town, which runs parallel with Charles River, the distance of two miles, and half a mile in breadth [i. e. the Hither and Further Plains], is very level, and is mostly of a light, sandy soil, not very deep. Adjoining the river it is fertile. The interior of the town is of a hard, loamy soil, upon a gravelly bottom, and tolerably fertile; in general the land is uneven, and in some parts rocky. Almost every farm is or may be fenced with stone-wall, from its own grounds; and probably few towns in the country exhibit more excellent walls. * * * * In the north and westerly parts of the town, the land is much broken, and somewhat hilly, but productive." There are a few high points of land in Waltham, considerably higher than any in Watertown. The highest and most conspicuous is *Prospect Hill*, about half a mile west of Waltham Plain. It rises with a regular rounded surface, like the back of a porpoise, to the height of 482 feet above tide-water. A large pine tree formerly stood on its summit, and it was one of the first points seen by mariners on approaching Boston harbor. It commands a very wide, diversified, and beautiful prospect. In an ancient record it is called *Knapp's Garden*. *Bear Hill*, west of *Prospect Hill*, and bordering on Weston, has about the same height. *Mackerel Hill*, near the N. E. corner of the town, is less elevated, but commands a beautiful prospect, including Boston harbor. It has borne this name from a very early date. The first hill within the ancient limits of Watertown, that is noticed in the early records, is *Mount Feake*, named for Mr. Robert Feake, of Watertown. It was discovered and named by Governor Winthrop and his exploring party, in January, 1631-2. It is too insignificant in magnitude to be entitled a *mount*, or even to be thus noticed as a hill; and the party must have been in a jocose mood, when they gave it its designation and importance. Much of it has been removed or destroyed of late in the grading of a railroad. There has been, heretofore, some uncertainty about its locality. [See Dr. Kendal's Centennial Sermon, p. 28.] This uncertainty seems to be dispelled. It was near the east border of the Oldham Farm, a little distance S. W. of the western

end of the Further [Waltham] Plain. According to the terms of the Grant of the Oldham Farm, in Ap. 1634, it lay "near Mount Feake, on the northwest of Charles River." Mr. Richard Browne had a grant of 12 acres of meadow "at Mount Feake, at the turn of the river," which was bounded W. by the Oldham Farm, and E. by the river.

§ 113. In the appendix to the Centennial Sermon of Rev. Dr. Samuel Kendal, of Weston [the farmers' precinct], he says: "The town is in general uneven, and in some parts, a broken tract of land. High cliffs or ledges of rocks are found within its limits. * * * A considerable proportion of the town is elevated above the common level of the adjacent country, and gives an extensive view of other parts. A hill of excellent land on the southwesterly part of the town presents a very extensive, and, in the month of May, a very romantic prospect. The soil in the elevated and rocky parts of the town is, in general, a deep-red strong loam, very favorable to the growth of fruit trees. There are several tracts of plain land; but these are of no considerable extent. The hills are mostly springy, and very little subject either to frost or drought. A number of brooks and rivulets accommodate the inhabitants, and pay their tribute to the bordering streams. The greatest part of these brooks rise within the town, and are fed by springs. There are few or no stagnant waters, but several tracts of meadow, that abound with excellent peat." No hills are named in Weston, in the early records.

ROADS.

§ 114. The attempt to identify the primitive or very early roads, residences, and other localities, is attended with much difficulty and perplexity, for reasons already stated. [See Sect. 84.] Most of the present roads in the town are undoubtedly of very early date, with slight changes or variations in some instances, but not such as to affect their identity. It is probable, however, that some highways, cartways, and lanes, then made use of to reach the very numerous small lots into which the town was at first divided, were long since vacated, or so changed that they cannot now be clearly identified with the originals. A few of the roads received names very early, and others are so described that they can be clearly identified.

§ 115. The earliest reference to roads in the town records, is in 1635, probably Sept. 14, when it was "agreed, that John Warren and Abraham Browne shall lay out all the highways, and to see that they be sufficiently repaired." In 1636 (probably in Nov.), it was "Ordered, that there shall be an highway left sufficient at the hither end all the great dividends or lots." In 1637, it was "Ordered, that there shall be eight days appointed for every year for the repairing the highways; and every man that is a soldier or watchman to come at his appointed time, with a wheelbarrow, mattock, spade, or shovel, and for default hereof, to pay for every day 5s. to the town, and a cart for every day to pay 19s." Dec. 30, 1637, it was "Ordered, that there shall be a highway between Ephraim Child and Thomas Rogers' ground, lying in Dorchester Field, leading to the Flats." This was probably what was sometimes called *Crooked Lane*, running between E. Child and John Sherman, who bought Rogers' lot after his decease.

§ 116. The two most important roads, at least the most so at first, were *Mill Street* and *Sudbury Road*, the one terminating and the other beginning at the Mill, near to the wear. *Mill Street* began below Mount Auburn, where Sir Richard Saltonstall began his plantation, and selected his homestall lot, and passing by the ancient graveyard, it extended to the Mill, at the first or lowest falls on Charles River. It did not long retain this name, but acquired that of the Cambridge Road, or the Road to the College, and sometimes the County Road. It has recently been named Mount Auburn Street.

§ 117. The road extending westward from the Mill, was at first sometimes called the *Country Road*, but it has been much more commonly known as the *Sudbury Road*, since the planting of that town. It was the *County Road*, and it is often designated as such in deeds, inventories, &c. It is now Main Street, and it retains this name through Waltham to Weston. It is said that, for a long time, there was more travel on it, than on any other road in the colonies. It was the great thoroughfare from Boston and its vicinity, passing over Boston Neck, through Roxbury, Brookline, New Cambridge (Newton), and over Mill Bridge; thence westward through Watertown, including Waltham and Weston; to the western part of the Colony, to Connecticut, New York, and the Southern Colonies. Some of this travel was diverted by the building of Cambridge Bridge; and still more by the Worcester turnpikes. The recent construction of railroads has diverted so much of what was retained, that as a thoroughfare it is now comparatively deserted. It has not been ascertained that the direct road from Cambridge to Waltham, which is very ancient, had any distinct name in very early times, when the first schedules of possessions were made. In later times it has been commonly designated as the *Back Road*, and recently it has been named Belmont Street. The road now called Lexington Street, beginning at Belmont Street, and extending northward by Elbow Hill, was anciently called the Concord Road. In Dec. 1638, it was "Ordered that the highway leading to Concord, shall be 6 rods broad." Whether that part of Lexington Street, extending southward from Belmont to Main Street, had any distinct designation in early times, has not been ascertained, but the whole of it is of a very early date. What is now called Howard Street, was at first called the *Way to the Little Plain*, and in later times, the Road to Dirty Green. That part of the present Pleasant Street, extending westward from Howard Street, was at first only a cartway, laid out for the accommodation of the Beaver Brook Plowlands in the Hither Plain; and in the early schedules of possessions, it was commonly called the *Way betwixt Lots*. [See Sect. 93.] That part of Pleasant Street, extending eastward from Howard Street to the Mill, was called the *Way to [along] the River*. That part of Common Street, extending northward from Belmont Street, was called *Stone Street*, and it had that name, where it turned southeasterly, until it reached Hill Street. That portion of Grove Street, extending northward from Mount Auburn Street, is the one referred to in the following order, passed, May 10, 1642: "Ordered, that an highway being laid out from Justinian Holden's lot, to George Parkhurst's house, six rods wide, and from thence to Richard Beers' lot, 2 rods wide, shall be for the use of the town forever." In the schedules of possessions it is called a *Drift Way*, and it extended only to R. Beers' lot. Washington Street, was at first called the *Way to the Pond*, and is frequently so mentioned in the early schedules. It extended directly to the Pond, and did not then turn towards Cambridge, as in the recent maps. There was another road, called *Pond Road*, north of Cambridge Street, running from Camb. Village, or meeting-house, towards Fresh Pond.

§ 118. The roads between Mount Auburn ["Mill"] Street, on the north, and the river on the south, at the west of Mount Auburn, differed very much from those delineated on recent maps. Ancient roads have been vacated and others laid out, and this greatly increases the difficulty of ascertaining the location of the grants and early possessions in that part of the town. *Bank Lane* is often mentioned by name, or referred to, in the early description of lots. It began near the Mill Bridge, extended eastwardly through Dorchester Field, passing along at a little distance from the river, and on the south side of Mount Auburn. It then turned northwardly, and was probably the same, which was then sometimes called *Water Street*. From the notices of it, as a boundary of lots, it may be inferred that its course was not direct, and that there is now no road corresponding with it, except perhaps the S. E. portion of what is now called Grove Street. That part of Common Street, or a road nearly coinciding with it, running southwardly from Belmont Street, over Strawberry Hill, was sometimes called *Bowman's Lane*. The homestead of Nathaniel

Bowman was on the west side of it, at a little distance south of Belmont Street. The present School Street, extending northward from Belmont Street, in the early schedules of grants and possessions, was called *Hill Street*, and it is often mentioned by that name.

§ 119. On the 24th March, 1640-1, at a town meeting, it was "Ordered, that there shall be a *cartway* through William Hammond's lot and Edmund James's meadow, and so through the lots of John Warren and Isaac Sterne, to fetch hay from Rock Meadow and the Remote Meadows." It is supposed that this cartway, beginning at Stone (Common) Street, answered to what is now called North Street, but that it began farther north than at present. In 1658, the selectmen ordered "Capt. Mason and Dea. Bright to lay out the highway through Corporal Hammond's land, from Mr. Eire's house to John Biscoe's land." Whether this order refers to a road corresponding in part with the present North Street, or to the northern part of Stone Street, is not clearly ascertained. As before stated, that part of the present North Street, east of Common Street, was then a part of Stone Street. North Street, extending westward, on the south side of Mackerel Hill, passed along near, and nearly parallel to, the northern border of Waltham, and it was known formerly as *Tropelo Road*. Febr. 7, 1658-9, "Ordered, a highway in the *way that goes to Chester Brook*," which was the west branch of Beaver Brook. *Busby's Lane* is often mentioned in the early description of lots. It began at Cambridge Street, east of Mount Auburn, and extended to the small homestall of 2 A. of Mr. Busby, originally granted to John Livermore, and situated on the East Bay of Fresh Pond. It is probable that the southern portions of School Street and of Common Street do not correspond exactly with the ancient streets running in the same direction.

PONDS AND WATER-COURSES.

§ 120. The earliest writers who notice Watertown, mention it as being well watered, and it has been supposed, with good reason, as already stated [Sect. 23], that it derived its name from this circumstance, as, in this respect, no other very early town could be compared with it. Besides the numerous springs noticed by early writers, but whose number and position cannot now be determined, the ponds and water-courses are numerous.

§ 121. When Watertown was first planted and named, *Fresh Pond*, the largest in the town, was entirely within its limits. After the planting of New Town (Cambridge), the northeastern and smaller portion of the pond was within the bounds of the latter. Since 1754, when the eastern part of Watertown was taken off and annexed to Cambridge, less than one-half of the pond has belonged to Watertown. This pond is renowned for the purity of its water, and for its ice, which is shipped in large quantities to all parts of the world. There are several much smaller ponds in the eastern part of the town to be seen on the map, but too small to have received any permanent designation. Two or three of them are enclosed in Mount Auburn Cemetery, one of which is called Forest Pond, probably the ancient Shallow Pond. Two others are a little further west, and another at the southwest.

§ 122. Farther west, within the bounds of Waltham, is another pond, about three-fourths of a mile long and half as wide, generally known as Sherman's Pond, sometimes, more recently, as Fiske's Pond, and Mead's Pond. Its area is supposed to be about 100 A. In the early records it is sometimes mentioned as the Great Pond, before it appears to have obtained either of the other names. It is within the northern or high grounds of Waltham, and is the source of the ancient Chester Brook, or West Branch of Beaver Brook.

§ 123. About half a mile west of the site of the old Waltham Meeting-house is a pond and an extensive bog, called Beaver Meadow, through which the ancient Chester Brook passes. There is good reason to believe that this bog was formerly covered with water, and was the pond to which Winthrop refers, where "the beavers had shorn down divers great trees, . . . and made divers dams across the brook," thereby making a large pond, and leaving a bog after the dams were destroyed. At a little distance south of this is a small sheet of water of about four acres, now called Lily Pond, having its outlet through Beaver Meadow into Chester Brook.

§ 124. In the western part of the town, as originally granted, were included a part, if not the whole, of Walden's Pond (now in Concord); a part of Sandy Pond, and the whole of Beaver Pond, both now in Lincoln, and a part of Nonesuch Pond, the larger portion of which is within the bounds of Natick.

§ 125. The town was watered on much the largest part of its southern border by the beautiful Charles River, originally called the Massachusetts River. Its average width is eight rods; tide-water extends about three miles above the eastern border of the town, and it is so far navigable for small vessels. At the head of tide-water was a fall, which furnished water-power for the first mill built in the town, and one of the earliest in the colony. [See Mills and Fisheries.] Above this are other falls, furnishing water-power for the Bemis Mills, and for the Upper and Lower Waltham Factories. These water-powers were not, however, made use of until a comparatively late date.

§ 126. Besides several streams, too small to have obtained permanent names, there were a few brooks, branches of Charles River, sufficiently large to furnish water-power for mills. *Smelt Brook*, having its source in Newton, passes through and enters Charles River within that small portion of Watertown which lies on the south side of the river. Mills have been built on it in Watertown and in Newton.

§ 127. The first considerable tributary to Charles River, on the north side, within the ancient boundary of Watertown, was *Beaver Brook*. Winthrop says, Jan. 27, 1631-2, "The Governor, and some company with him, went up Charles River about eight miles above Watertown, and named the first brook on the north side of the river (being a fair stream, and coming out of a pond a mile from the river) Beaver Brook, because the beavers had shorn down divers great trees there, and made divers dams across the brook." This brook, which enters Charles River at the lower end of Waltham Plain, is made up of two main branches, which unite about 250 yards from the river. The west branch originates in Sherman's Pond, and after a course of about two miles, passing through Beaver Pond, and through what was long known as the Livermore Farm, but of late as the Lyman Farm, unites with the east branch. The volume of water is sufficient for a mill, which was built upon it, probably by Dea. Thomas Livermore, in the early part of the last century. The eastern and larger branch begins in Lexington (Cambridge Farms), and, passing through the western corner of West Cambridge, and through Rock Meadow, it runs most of its course through the eastern border of Waltham until it joins the west branch. A fulling mill was first built upon it in 1663, and afterwards other mills, on or near the present site of Kendall's Mills.

§ 128. It is evident that Gov. Winthrop did not explore that locality, as he does not give correctly the source of the west branch, nor refer to the other branch. The author of the "Topographical and Historical Description of Waltham," adopting Winthrop's statement, appears to regard the west as the main branch, as the true Beaver Brook, and the eastern branch as a tributary. This must be erroneous. By consulting ancient deeds and surveys of roads, it will be found that the eastern branch, in early times, always bore the name of Beaver Brook, and that the western branch, coming out of Sherman's Pond, was the ancient Chester Brook, upon which Chester Meadow was situated, probably not far below the mill. These were named for Mr. Leonard Chester [see p. 735], and must have received their names very soon after that excursion of Gov. Winthrop, as Mr. Chester arrived in 1633, and left

Watertown in 1636. Some modern improvers have given the name *Clematis* to the middle portion of the ancient Beaver Brook.

§ 129. About 350 rods west of Beaver Brook, a small stream enters Charles River, which has occasioned some perplexity, owing to Winthrop's account of it. It is too small to be deserving notice except for this circumstance. From its relation to Adam's Chair and Mount Feake, as given by Mr. Winthrop, this small stream, now almost dried up, must have been Masters' Brook. Yet he says it was "greater than the former" (Beaver Brook). It is evident, from its channel and its sources, that it could never have had such a magnitude, which is applicable only to Stony Brook, which is a mile west of Mount Feake. The latter bore its present name at least as early as 1640 or '41, and has always retained it; while the small stream, near Mount Feake, has been known as *Masters' Brook* until a late date. We are compelled to conclude, either that Winthrop, through inadvertence, wrote greater for smaller, or that, upon returning from his excursion, and writing in his journal, his recollection of the localities had become confused.

§ 130. The largest tributary to Charles River, within the ancient bounds of Watertown, is *Stony Brook*. It originates in Sandy Pond, which is near the north-west border of Lincoln, and is partly within the original bounds granted to Watertown. It runs a S. S. E. course, passing through Beaver Pond, until it unites with Charles River, about two miles above Beaver Brook. Its principal branch is the ancient *Stower's Brook*, for which, in modern times, a less euphonous name, Hobb's Brook, has been substituted. It originates in a small pond near the eastern border of Lincoln, originally within the bounds of Cambridge Farms (Lexington), and, after a course of about four miles nearly due south, it unites with Stony Brook, about two miles from its junction with Charles River. This is supposed to be the same stream which was sometimes called *Four Mile Brook*. On the west side and above the junction of Stower's Brook is another smaller branch called *Cherry Brook*. It is large enough to be used for a small manufactory. It is probable that Cherry Meadow, sometimes mentioned in ancient records, was upon this stream. Stony Brook furnishes valuable water-power, and there are several mills upon it. [See Section 143.]

THE WEAR AND FISHERY.

§ 131. The fishery in Charles River, at Watertown, has always been deemed of considerable importance, but much more so in early, than in latter times. Johnson [Wond. Work. Prov.] says: "This town [Watertown], abounds with several sorts of fish at their seasons, bass, shad, alewives, frostfish, and smelts." Wood [New England's Prospect, 1633] says, "A little below this fall of waters, the inhabitants of Watertown have built a wear to catch fish, wherein they take great store of shads and alewives. In two tides they have gotten one hundred thousand fishes." In the spring of 1632, this wear was constructed by the permission and encouragement of Gov. Winthrop, but without an order, which could be granted only by the General Court. He gave this permission, because, if they had waited for a meeting and order of the Court, the season for fishing would have passed, before the wear could be constructed. At the next meeting of the Court, May 9, 1632, "It was ordered, that the town of Watertown shall have that privilege and interest in the wear they have built, up Charles River, according as the Court hereafter shall think meet to confirm unto them." On the 3d of Sept., 1634, the Court "Ordered, that no man shall fish with a net nearer the wear at Watertown, than the further part of the island in the river, and there also, never to cross the river wholly with any net, except it be at high water or after." Notwithstanding the reasonableness, almost the necessity of the

action of the Governor, and the early sanction of the Court, that permission of Governor Winthrop was, not long afterwards, one of the points of accusation brought against him by Dudley, the disaffected and unfriendly deputy Governor.

§ 132. It is not known who took the lead in the construction of the wear, but it is not improbable that it was the energetic and enterprising Mr. John Oldham, whose "house near the wear at Watertown," was burned down in August of that year (1632). [Winthrop, I., p. 87.]

At a town meeting (of the freemen), in Jan., 1635-6, it was "agreed, that there shall be four rods in breadth on each side of the river, and in length as far as need shall require, laid [out] to the use of the wear, so it may not be prejudicial to the Water Mill. Also, one hundred and fifty acres of ground to the wear upon the other side of the river, to be laid out in a convenient place."

§ 133. The orders of the Court, just quoted, imply that the wear was built by or for the town, and was public property. If so, it not long afterwards became private property, and was held in shares. The 150 acres granted by the town, passed with the wear to Mr. Mayhew, and it was confirmed to him by an order of the Court, June 2, 1641, when it was "agreed, that Mr. Mayhew shall enjoy the 150 acres of land on the south side of Charles River, by Watertown wear."

§ 134. On May 29, 1639, Thomas Mayhew mortgaged to Matthew Cradock, of London, one-half of the Mill (which he had purchased of Mr. C.), and six shares in the Wear at Watertown, as security for £240. On Feb. 27, 1639-40, Mr. Mayhew conveyed to Gov. Dudley, for £90, the rent of his wear for the last four years, which is, by lease, let to Robert Lockwood, Isaac Sternes, and Henry Jackson, for six years; also, the river-side and inheritance of the wear forever, subject to a certain mortgage [to Mr. Cradock]. On the 6th of March, 1643-4, for £59.10.2, Dudley sold to Edward How all right and income in the wears in Watertown, except £22.15.6, due from Isaac Stearns and Robert Lockwood. Elder Edward How, by his Will dated June 3, 1644, conveys to his heirs "the wears with all their privileges thereto belonging;" and they continued for many years in the possession of his two sons-in-law. Mar. 30, 1662, Nathaniel Treadway, with Sufferana (How), his wife, sold to Nathaniel Coolidge, all his right in the wears on Charles River, near the Corn Mill; and on May 26, 1663, John Stone, of Sudbury (the other son-in-law of Mr. How), sold to Nathaniel Coolidge, all his right in the river and fishing wears in Watertown, being the one-half thereof.

§ 135. At a town meeting held Ap. 12, 1671, "Upon consideration, that the Indians being like to buy the privileges of the wears and fishing at the river, which the town apprehend will be much to the damage of the town, they being like to be bad neighbors, the town voted, all, as one man, that they were altogether against their having the wears, or that they should set down so near the town." At the same time it was voted to purchase the wears for the use of the town, and a committee was chosen to treat with Nathaniel Coolidge on the subject. From that time the wears have continued to be the property of the town, and have been annually rented at the highest price that could be obtained.

§ 136. At the time of the purchase of the wears of Coolidge, Watertown comprised the territory of Waltham and Weston, and when these towns were incorporated, they retained a joint proprietorship in the wears, which continued until the commencement of the present century. It was finally cancelled at the same time, and on the condition, that they were exonerated from the burden of contributing to the maintenance of the Great Bridge over Charles River. [See Sections 146-155.]

§ 137. Mar. 8, 1742-3, the County Court granted the petition of Richard Beers, and others of Waltham, to construct a wear in Charles River, provided they leave one-third of the river free for fish to pass and repass.

§ 138. As early as 1738, altercations arose between Watertown and the towns situated on the other side of the river, respecting their claims to the fishery. In that year, the people of Newton, Needham, Medfield, and Sherburne, presented to

the General Court a complaint against the inhabitants of Watertown, for stopping the course of the fish in Charles River. At the same time a complaint of the same tenor, was presented by the Indians of Natick. The representative of Watertown, Jonas Bond, was directed to defend his constituents in opposition to these petitioners. The complaints and altercations were afterwards frequently reiterated.

§ 139. The number of fish resorting to this river has gradually and greatly diminished since the first planting of the town, especially within the last half century, and the value of the fishery has, of course, declined. The profits of the fishery have of late been divided between Watertown and Brighton, the former receiving seven-tenths thereof, and the latter three-tenths, which division has been the result of litigation.

MILLS.

§ 140. Neither the exact date nor the builder of the first mill in Watertown have been ascertained; but it was probably built, in 1634, by Edward How, at the joint expense of himself and Mr. Matthew Cradock. It was built at the first fall, at the head of tide-water, on Charles River, on "Mill Creek," which was a canal partly or wholly artificial, leaving the river at the head of the falls, where a stone dam was made across the river. It is probably the oldest artificial mill-race or canal in this country that has continued in uninterrupted use. The mill is not mentioned by Wood [New England's Prospect, 1633], who mentions the wear and the falls, where the mill was built; but it was built before August 19, 1635,* when Mr. Edward How sold one-half of it to Mr. Thomas Mayhew for £200, for which Mayhew gave a bond and mortgage for £400, with condition, that if said Mayhew pay said How £200, the bond to be void, else said How shall enter upon the moiety of the mill, as if he had never made sale thereof. Mr. Mayhew bought the other half of the mill of Mr. Cradock, through his agent, Nicholas Davison, and on the 29th May, 1639 (perhaps the day of purchase), mortgaged this half of the mill, with six shares of the wear, to Mr. Cradock, as surety for £240. On the 18th April, 1640, Mr. Mayhew, for £400, sold to Thomas Dudley, Deputy-Governor, one mill, "bought of Edward How, Elder of the Church of Watertown," and of N. Davison, agent of Mr. Cradock of London, subject to the mortgage to Mr. Cradock. This mortgage to Mr. Cradock was redeemed by Mr. Dudley on or before Mar. 7, 1643-4. No evidence has been discovered of the redemption of that mortgage of Mayhew to How, and that bond of Mayhew was one of the items in the Inventory of Mr. How, who died in the summer of 1644. From this statement of the facts, it is not strange that Mr. How should urge his title to the mill with pertinacity; and notwithstanding Winthrop's statement [II. p. 50], which seems imbued with partiality or personal pique,† there is reason to surmise that the official influence, and domineering disposition of his antagonist, gave a shape to the decision of the Court. Gov. Dudley died July 31, 1653; the next September a petition was presented to the General Court, by his executors, requesting that the legatees, to whom "Mr. Dudley gave Watertown Mill, have power to dispose of it for the use of the heirs;" which petition was granted. The greater portion of the mill was probably purchased about this time by Mr. William Paine, first of Watertown, afterwards of Ipswich and Boston. His son, John Paine, of Boston, on the 20th Jan., 1663, conveyed the mill as security to Samuel Appleton, of Ipswich, who had married Hannah, the only daughter of William Paine. [See Paine, p. 384, and also Mid. Deeds, III. 51.] On the 1st Sept., 1676, Samuel Appleton, on behalf of his dr. Judith, sued Caleb Church for the possession of five-sixths of the corn-mill in Watertown. It appears by the Will and Inventory of

* A grant of land was made to the mill in Jan. 1634-5.

† The lead, which Watertown people had taken in resisting Gov. Winthrop's policy of taxation without representation; and their adoption of strict Independence, in opposition to his politico-ecclesiastical policy, produced a prejudice against them, in his mind, which on several occasions he ill concealed.

Thomas Dudley, Jr., a grandson of the Governor, that his share of the mill, "my grandfather Dudley gave me," appraised at £40, had not been sold in Nov., 1655, but by the will was directed to be sold. Mr. Thomas Danforth was one of the executors, and probably bought this share, which may have been that one-sixth which did not come into the possession of Mr. William Paine and his heirs. Hon. Thomas Danforth and others, who had become proprietors of the mill previous to Nov. 30, 1686, when they had erected a fulling-mill adjoining to the corn-mill, asked and obtained liberty of the town to build a house on the N. side of the [mill-] stream. Oct. 6, 1710, Mary, daughter of Hon. Thomas Danforth (wife, first of Solomon Phipps, Jr., and afterwards of Thomas Brown of Sudbury), by deed conveyed to her daughters, Sarah and Abial, all her rights in the corn-mills and fulling-mills on Charles River in Watertown. [See p. 197, note.] The subsequent line of proprietors and occupiers of the mills has not been ascertained; but they were for many years occupied by Stephen Cook, Jr., and afterwards by David Learned. In 1653, the mill was rated at £140 for the support of the ministry.

§ 142. The next mill built in Watertown was a fulling-mill, built on Beaver Brook, supposed to be on or near the spot where are now Kendall's Mills. May 30, 1662, Timothy Hawkins sold to Thomas Agar, of Roxbury, fuller, three-fourths of an acre of land, bounded N. and E. by Richard Sawtel; W. by land of Thomas Smith; S. by Wm. Knapp; E. by lands in common [? boundary of Hawkins' whole lot], with all the accommodation of water, for the erecting and maintenance of a fulling-mill in the said place, and on the (?) river that passeth through the same; also the right of way. Dec. 18, 1663, Thomas Agar, fuller, of Wat., sold the same lot of land, with the fulling-mill thereon erected, to Thomas Loveran, late of Dedham, Co. Essex, Old England, cloth-worker. Jan. 3, 1669-70, T. Loveran sold this land and mill to Timothy Hawkins and Benjamin Garfield, described as surrounded on all sides by land of T. Hawkins. [Mid. Deeds, III. p. 52-7, and IV. 72.] A corn-mill was erected there before 1690, of which, at that time, Thomas Rider was proprietor, and mortgaged the mill and 30 acres of land to Dr. Philip Shattuck the next year. In 1700, the mills or a part of them, belonged to Samuel Stearns, son-in-law of T. Hawkins. [Mid. Deeds, XII. 515 and 625.]

§ 143. The next mill in Watertown was on Stony Brook, and probably built at the joint expense of John Livermore, Richard Child, and Josiah Jones, of Watertown, and John Heywood, of Concord. Feb. 19, 1678-9, they bought of Nathaniel Treadway and wife 30 acres, in lieu of township,* bounded S. E. by George Parkhurst, and N. W. by Joseph Underwood. At a town meeting, Jan. 5, 1679-80, it was "granted that the new corn-mill, now set up and to be finished at Stony Brook, be freed from rates for 20 years, from Jan. 5, 1679-80." On Mar. 3, 1683, John Heywood, of Concord, and wife Anna, for £60, sold to John Livermore one-fourth part of Stony Brook Mills; and on Ap. 21, 1684, Josiah [? Lewis] Jones and wife Lydia, for £60, sold to John Bright all his one-fourth share of mills at Stony Brook, viz., 30 acres bought of N. Treadway, and land bought of John Chadwick, with houses, &c. These mills were probably owned some time by Lieut. John Brewer, and afterwards, for a long time, known as Bigelow's Mills. [See Section 130.]

§ 144. The mills, built on the three points just referred to, were the only ones in the town for the first seventy, probably the first hundred, years after its settlement. During the last century, at dates not ascertained, several other mills were built within the ancient limits, including Waltham and Weston. One, long known as the Bemis Mill or Factory, was built on the river, about one mile above the "Old Mill." Another, on the river, about a mile and a half further up, was built by John Boies, where the Waltham Factory has since been built; another on Smelt Brook, on the south side of the river; another on the ancient Stower's Brook, of late known as Hobb's Brook; another on the ancient Chester Brook. Since the beginning of the

* This was probably the 30 A. lot, No. 43, beyond the further plain, granted to Edward How, and sold by his son-in-law, Treadway.

present century, mills, large and small, for various manufacturing and mechanical purposes, have been so multiplied and enlarged, within the original limits of Watertown, as to absorb a large amount of capital, employ nearly or quite all the water-power, and give employment to very numerous families.

FERRY AND BRIDGES.

§ 145. In the town records there is no notice of any *ferry*; but in the Colonial Records, is the following license. By the Court, Nov. 5, 1633, "Mr. Richard Browne, is allowed by the Court to keep a *ferry* over Charles River, against his house, and is to have 2d. for every single person he so transports, and 1d. apiece, if there be two or more." The spot where this was kept has not been ascertained. Probably it was a little to the East of Mount Auburn, where he had 2½ A. of marsh, bordering on the river, and 7 Acres of upland, which he sold early to R. Wellington.

§ 146. There are several bridges within the bounds of Watertown, mentioned in the early records. The earliest, and much the most important, was that built over Charles River, at the head of tide-water, very near the first mill, and usually called Mill Bridge, or the Great Bridge. The earliest reference to this bridge is in the records of the General Court, June 2, 1641, when it was ordered that "the toll of Mr. Mayhew's bridge is referred to the Governor and two magistrates, to settle for seven years." The right or privilege of a toll-bridge was not granted, as appears by the record of the Court, for Oct. 17, 1643, when the Court granted Mr. Mayhew "300 acres of land in regard of his charges about the bridge at Watertown Mill, and the bridge to belong to the country."

§ 147. The next May (1644), the Court ordered this grant to be laid out to Mr. Mayhew, and appointed a committee (Peter Noyes and Edmund Goodenow of Sudbury), for that purpose. It was probably located in or near Nashaway; but there is no record of it. It is evident from the transactions not long afterwards, that this was only a foot-bridge; and, although it was "to belong to the country," there was no provision, in the above grant to Mr. Mayhew, for the repair and maintainance of it. Very soon after obtaining that grant, Mr. Mayhew moved to Martha's Vineyard.

§ 148. The following preamble and order, in the records of the General Court, for May 26, 1647, show the origin of the first horse-bridge; and the terms imply that it was the first one ever built across Charles River. "Whereas, complaint hath been made to this Court of the great want of a horse-bridge near unto Watertown Mill, and that the want thereof hath hazarded the lives of several persons, and may endanger many more, and for that *the best and most commodious place is in the bounds of Watertown*, it is ordered by the authority of this Court, that there be a sufficient horse-bridge made over the river there, by the inhabitants of Watertown, before the first of the 9th month [Nov.], next ensuing, upon pain of forfeiture of £10, and after that 10 shillings a day to the country, till it be made up as aforesaid."

§ 149. Watertown did not immediately comply with this order; for, on the 11th of November, 10 days after the time assigned for finishing the bridge, the Court "granted the town of Watertown to the first of the 4th month [May] next, upon the penalties prefixed to the former order; also, they have chosen Mr. Hibbens, Mr. John Glover, the surveyor-general, and Edmund Rice, before the first of the first month [March] next, to view and appoint a place to put up the bridge *for the benefit of the country and town within the bounds thereof.*" At a town meeting Dec. 28, 1647, "the town appointed Mr. [Nathaniel] Biscoe and Isaac Stearns to consider

how the bridge, over the river, shall be built, and to agree with the workmen for doing it according to their best discretion." As it was not completed in the time specified, upon petition the Court granted that Watertown shall "have till the 10th of the 7th month [Sept.] next, for building their bridge, under the former penalty in the last Court order." When the bridge was completed, does not appear in the records, but on the 28th of the next November (1648), the selectmen ordered payments to be made to M^r. Biscoe and Isaac Stearns for work done at the bridge.

§ 150. The construction and materials of the bridge were so defective, that it required not unfrequently to be repaired or rebuilt; and, for the first hundred years, Watertown felt the building, rebuilding, and maintainance of it to be a heavy burden, and repeatedly asked aid from the county, but without success. It appears in the above cited grant to Mr. Mayhew, that the bridge was "to belong to the country," not to the town, and in the order of the Court, the committee were "to appoint a place to put up the bridge for the benefit of the country."

§ 151. In less than twenty years it was found necessary to rebuild the bridge, and in Nov., 1667, the selectmen ordered that the land on the Meeting-house Common, upon the W^e side of the way from the meeting-house to pastor Sherman's house, shall be sold, and the pay to go towards building the bridge at the Mill; and in the same month the land was sold to John Coolidge, Jr., for 20 shillings per acre. The selectmen agreed that the bridge should be built with baskets, and in Dec. they agreed with John Coolidge, Jr., to build the bridge for 40 shillings a basket; the baskets to be each 8 feet long, 6 feet broad, and 7 feet between the joints; the town to fill the baskets, with stones, to lay the timbers in place, the sill to be laid even with the ground; the bridge to be half trees, slit with a saw, to be three abreast to each basket, and the bridge to be at least three feet wide, to be done by the first of September. At a town meeting, Dec. 10th, three days after the bargain with J. Coolidge, Jr., it was voted not to allow what the selectmen had done about the sale of the land on Meeting-house Common, and about the bridge. The width of the bridge shows that it was not designed for carriages, but only for horses, cattle, and pedestrians. Whether this scheme of the selectmen for building a bridge was carried out, the records do not show.

§ 152. A committee on the bridge was appointed Aug. 3, 1681, and the next month, Sept. 20, £14 was put in the hands of Caleb Church, the miller, to procure liquor, as cheap and good as he can, for the comfortable carrying on the work at the bridge. Mar. 28, 1684, the selectmen desired Caleb Church, to make the bridge over Mill Creek, the old bridge being carried away by the flood. The bridge over the river appears to have been destroyed before May, 1694; for in that month the selectmen and surveyors agreed with John Barnard, Jr., for the carpentry of Mill Bridge, he to provide 5 or 6 hands, if he can; he to have 3s. 6d. per day and find himself, and the hands half a crown a day, and find themselves. The bridge was not immediately built, for on July 24, 1695, the town voted that Ensign Barsham, David Fiske, and Daniel Warren, Jr. (surveyors), take care that there be a bridge built over Charles River, as near the place where it stood before as may be conveniently, and that it be a *foot bridge*; also that Corp. (Joseph) Sherman, Ensign (John) Hammond, Serj. (Samuel) Thatcher, and John Stacey, be added to the surveyors, in advising how, &c. Sept. 6, 1695, there was a presentment against the town for want of a bridge over Charles River, to which it was replied that it was repairing. Again, as early as 1714, there was a presentment for the want of a bridge over Charles River, and the town appointed a committee in May, 1713, and again in May, 1714, to apply to the Court to have Charles River Bridge maintained by the County of Middlesex. June 8, 1714, the Court do not see cause to comply with the petition of sundry principal inhabitants of Watertown, but dismiss the same. The next month, July 13, the selectmen of Watertown, appearing in Court to answer the presentment of said town for want of a bridge over Charles River, near the Mill, the Court, upon view of the record of the Honorable [General] Court's grant of land for charge about the

bridge, by or near Watertown Mill, asserting the bridge to belong to the country, the Court dismissed the presentment for the present, they paying the fees. The next year, July 5, 1715, the selectmen appearing in Court on the same presentment, say the bridge was built at the charge of the country, and was so to remain, as appears from a copy of a record of the General Court (referring to the terms of the grant to Mr. Mayhew), and the Court continued the consideration thereof, till the next Quarter Sessions. The same subject coming before the Court the next year, Ap., 1716, the Court, finding that Watertown has maintained and supported a foot and horse bridge over said river, upwards of fifty years, order Watertown to repair said bridge forthwith.

§ 153. In the present state of private and public pecuniary resources, and the great progress made in civil engineering, the building of a bridge over Charles River would be regarded as a very trifling, unimportant enterprise. But it was not so in early times. For the first eighty years after its settlement, the whole assessed value of Watertown was less than a twentieth part of the estate of a single inhabitant at this time. The expenses of supporting the ministry, schools, the government, and paupers, the building and repairing of meeting-houses and school-houses, the making and repairing roads, and the occasional heavy charges and losses resulting from Indian warfare, occasioned a very heavy taxation. As an illustration of this, it may be observed, that the annual expense of supporting the ministry alone, in the time of the Rev. John Sherman, was about two per cent. upon the whole assessed value of the town. Under these circumstances, it is not strange that Watertown should often complain of being compelled to maintain "the Great Bridge," for the convenience of the country, at their own expense.

§ 154. Upon the incorporation of Weston and of Waltham, one of the stipulations upon which the rest of the town consented thereto, was that those towns should continue to render their proportional aid in the maintenance of the Great Bridge; and this arrangement continued until the commencement of the present century. In the records of the several towns may be found frequent reference to this business. For an account of the time and manner in which this joint responsibility was cancelled, and the whole devolved upon Watertown, see Francis, p. 116; and Section 136.

§ 155. The other bridges mentioned in the early records were those over Beaver Brook, Stower's Brook, Smelt Brook, and Chester Brook. The first mention of the bridge over *Beaver Brook* (in Sudbury Road, now called Main Street) was Oct. 8, 1673, when the selectmen paid for "a gallon of liccur at the putting down of Beaver Brook Bridge." There was a presentment against the town in 1695, and again in 1705, for want of a bridge over *Smelt Brook*. At the last presentment, Jonas Bond, Esq., in behalf of the selectmen, answered, it was a shallow place, and a good bottom, and needed not a bridge; yet the Court ordered that the said way be forthwith mended on pain of paying £5. In April, 1713, the town was presented for suffering the bridge over *Stower's Brook*, in the upper way [the road leading to Lincoln], orderly laid out, to be defective. It was answered that there never was a bridge over *Stower's Brook* at that place. The next December, a report was accepted as to the way called *The Old Way* [crossing the brook near Hobbs's Mill]. In Aug., 1719, the town was again presented for not building a bridge "over *Stower's Brook*, on the town road [the upper way] leading to the northerly Precinct of Weston." Major Jonas Bond, in behalf of the selectmen, presented their plea, that they were under heavy charges for building the Great Bridge; but the Court ordered the way to be speedily repaired. In the preceding January, the town had agreed with Thomas Learned and Capt. Thomas Prentice to rebuild the Mill Bridge over Charles River. A bridge over *Chester Brook* is sometimes mentioned at an early date, but at what time or place it was first built, has not been ascertained.

§ 156. *The Cowpen Farm.* Nov. 2, 1649, the town appointed John Sherman to get a pen of one acre, fenced with four rails, for "lodging a herd in the woods, and to procure a small house for lodging the herdsman, towards Sudbury bounds."

Mar. 31, 1651, the selectmen engaged Solomon Johnson, as herdsman, at £25 per annum, and allowed him the use of the house. Dec. 16, 1651, an agreement between the selectmen and Johnson was signed, making him herdsman for seven years. Seven years afterwards, Oct. 1, 1658, another agreement with Johnson, as herdsman, was signed. Sept. 4, 1660, a committee (Serj. Beers and Serj. Bright) was sent to the Cowpen Farm, to examine the condition of the fences, housing, &c., and they reported that Johnson had not performed his covenant; and on the 5th Dec., 1660, articles of agreement were signed by the selectmen and Henry Curtis, relating to the Cowpen Farm, leased to him for seven years, with 40 A. of upland, of which 13 A. are broken up land (leaving out the land of John Sawin), also 20 A. of meadow; the rent free the first year, and he to pay £5 a year for the other six years. At the same time, a committee (Serj. Beers, Serj. Bright, and Nathaniel Treadway) was appointed to run the line between John Sawin and the Cowpen, and to stake out 70 A. for the Cowpen Farm. When this farm was first laid out, by mistake, it encroached upon land of John Sawin, and "to prevent differences," the town agreed, Ap. 12, 1659, to pay John Sawin. This farm of Sawin was the lot in the Dividends originally granted to Bryan Pendleton; by him sold to Peter Noyes; by him sold to George Munnings; by him sold to John Sherman; and in Ap., 1653, repurchased of Sherman by Munnings, in behalf and for the use of John Sawin, his son-in-law, and his grandson, John Sawin, Jr. In Dec., 1661, the following were the boundaries of this farm: W., Sudbury Line; N., Highway; E. by farm land, "which Curtis doth farm;" S., common land. This farm land, cultivated by Curtis, was probably the farm originally granted to Capt. Daniel Patrick. [See Section 104.] Oct. 1, 1662, it was "agreed [by a vote of the town] that the Cowpen doth belong to the farm land," and it was voted, Jan. 18, 1663-4, that Henry Curtis hold the lease until it expires. But, on the 7th Nov., 1664, the town ordered the Cowpen Farm to be sold; and on the same day it was bought by John Livermore, Sen., and given to his son, John, by whose family it was held for a long time. It is probable that the Cowpen ceased to be used for its original purpose, sometime before this sale of it.

GRAVEYARDS.

§ 157. The earliest mention of a burying-place, in the town records, is July 5, 1642, when it was "ordered, that Hugh Mason, Thomas Hastings, and John Sherman, are appointed to set up a sufficient [fence] about The Burying-place, with a five foot pale, and two rails well nailed, by the 15th of 2d [? 7th] month, and the town to pay them for it." The next December 20th, a rate was ordered, and one item was, "for fencing the burying-place, £6 10s." Its location is not described; but it was doubtless what is now known as The Old Graveyard of Watertown. It is at the S. E. corner of Mount Auburn Street [Mill St., or Camb. Road] and Grove Street. It is about half a mile west of Mount Auburn Cemetery. The terms of the above order imply that it was then in use, and well known as the burying-place, and it is probable that it had been used for sepulture from the first planting of the town. If any other lot was used for the same purpose before it, it must have fallen into disuse very soon, leaving no vestige or tradition of its existence. There can be only extremely few, if any, older graveyards in New England, and it was the only one in the town (then including Waltham and Weston) for more than seventy years. In it repose the remains of the Puritan progenitors and kindred of hundreds of thousands of people, not only of those who have lived, or are living, in almost every town and village of New England, but of very many who are dispersed throughout North America. Some evidence of this may be found in the preceding genealogies.

§ 158. The origin of the two next graveyards are of the same date. At a town meeting, Jan. 1, 1702-3, it was "voted that they give liberty to the Society belong-

ing to the Middle Meeting-house [Mr. Angier's], and the Society belonging to the Farmers' Meeting-house, to choose and appoint some convenient place for each Society for burying-places to bury their dead in, or for any others belonging to said town, and make return of their doings therein. 2d. Voted that if the said burying-place or burying-places cannot be procured without paying for them, the inhabitants will pay for them, as they can agree, or as they shall be valued by independent inhabitants mutually chosen." At a town meeting, Oct. 23, 1704, it was "voted, that the town will give Richard Blois three pounds in money, and all the land lying between Capt. Benjamin Garfield's field, Beaver Brook, and the Country Road, and the road leading over Beaver Plain to be four rods wide through said land, the said Blois giving to the town treasurer a deed of the land, as it is already laid out, for the use of the town forever for a burying-place for the middle part of the said town." This land of Blois's was probably the 4 A. lot of upland in the hither plain, granted to his father, Edmund Blois, bounded N. by the highway; W. by common land [*i. e.* not yet granted]; E. by John Loveran. This land,* conveyed to Blois in exchange for the burying-ground, afterwards belonged to Daniel Flagg, and at a town meeting, Mar. 6, 1720-1, "liberty was granted Daniel Flagg to fence in the Westerly Burying-place in Watertown, making a gate." At a town meeting, Jan. 3, 1722-3, it was "voted to accept of the highway laid out by Daniel Flagg, near Beaver Brook, which is on the side hill, instead of going through the low land, where it was formerly." This is now called Grove Street. This continued to be the only graveyard of Waltham for more than one hundred years. Other lots have of late been appropriated to the same use. We find nothing further in the town records respecting the burying-place of the Farmers (Weston); but it appears by the Mid. Reg. of Deeds, that, previous to May 3, 1704, Mary Sherman (wid. of Rev. John S.) and James Sherman, of Sudbury (ex'rs of Rev. John Sherman) had sold part of a 4 A. lot, near the Farmers' Meeting-house, for a burying-place.

§ 159. The second graveyard, within the present limits of Watertown, is situated at the intersection of Mount Auburn and Common Streets, on the N. side. The date of the appropriation of the land to this purpose has not been ascertained; but it was probably about 1754, when a meeting-house was built there. Since this lot was opened, there have been comparatively few interments in the old, or lower graveyard.

§ 160. Within the present century other graveyards have been laid out, one of which is renowned for its extent, its natural beauties, and all the additional attractions, which wealth and refined taste can give it. But, although Mount Auburn Cemetery is within the limits of Watertown, it cannot, with propriety, be deemed one of its graveyards. It is the burial-place of the wealthy and distinguished of the metropolis of New England, and of a wide region around it. It is situated in the midst of that region of small lots where the first planters of the town first settled, and as it contains more than 100 acres, it probably includes a very considerable number of those ancient homesteads; but their exact localities are not sufficiently well ascertained to determine who were the original grantees of the lands. Deacon Simon Stone had a grant of 12 A. of upland, supposed to be the southern border of the cemetery, and previous to 1644, he had purchased several other adjoining lots, so that, at this date, his homestead contained 50 acres, and probably much of it is embraced within this cemetery. Much of the land in the cemetery is not adapted to tillage, and it long bore the name of Stone's Woods.

INDIANS.

§ 161. The history of Watertown has been very little implicated directly with the Aborigines. It never suffered a hostile invasion by them, and was often a refuge of those who fled from other plantations to escape the atrocities of Indian warfare. It

* This lot was the residence of the late John Bright, Esq., and it is now occupied by his heirs.

had an Indian name (Pequusset), and it is not improbable that it was an Indian settlement, before the country had become so nearly depopulated by a very fatal epidemic. The advantages of Watertown for planting, beaver hunting, and especially for fishing, must have been attractive to them. We have not discovered that the English settlers ever purchased the territory of Watertown from the Indians, except probably a small claim, in 1638, on the south side of the river. Capt. Roger Clap says, that the ten Dorchester men, from on board the *Mary and John*, who went up to Watertown on the 31st May, 1630, when they had encamped in Dorchester Field, learned that 300 Indians were in their neighborhood. These were probably the Nonantum Indians; for Nonantum was only a short distance from Dorchester Field, on the other side of the river. It is not improbable that their number, in this instance, was much exaggerated. "Upon a complaint made by Sagamore John and Peter, for having two wigwams burnt, which, upon examination, appeared to be occasioned by James Woodward, servant of Sir Richard Saltonstall, it was therefore ordered that Sir Richard should satisfy the Indians for the wrong done to them (which accordingly he did by giving them seven yards of cloth), and that his said servant should pay unto him for it, at the end of his time, the sum of *£s.* [50s]." [Colonial Records, Mar. 8, 1630-1.] On the 4th Sept., 1632, the Court ordered a severe penalty to be inflicted on Richard Hopkins, of Watertown, for selling guns, powder, and shot, to the Indians.

§ 162. At a General Court, Sept. 6, 1638, "it was agreed that the Court of Assistants should take order for the Indians, that they may have satisfaction for their right at Lynn and Watertown." The next spring, Mar. 12, 1638-9, "the Court desired Mr. Gibbons to agree with the Indians for the land within the bounds of Watertown, Cambridge, and Boston." May 13, 1640, by the Court, "it was ordered, that the *£23 8 6*, laid out by Capt. Gibbons, shall be paid him, *vidt.*, *£13 8 6* by Watertown, and *£10* by Cambridge; and also Cambridge is to give Squa Sachem a coat every winter while she liveth." The situation and extent of the land purchased at this time are not given; but it was probably the Indian claim to "the wear lands," and Nonantum, on the south side of the river. This conjecture is favored by the circumstance, that Cambridge [Newton] and Boston [Muddy River] were embraced in the commission, and that Watertown and Cambridge paid the expense.

§ 163. In 1671, an attempt was made by Indians to purchase of Nathaniel Coolidge the fishing wears, with their privileges, in Watertown; but this was effectually resisted by the town. [See [28] p. 747, and Section 135.]

§ 164. Although the town was never invaded by hostile Indians, Watertown soldiers and emigrants encountered their full share in Indian wars and massacres. An early and very notable instance was the massacre of Mr. John Oldham, at Block Island, in July, 1636, which was the immediate cause of the exterminating Pequot war. Aug. 25, 1636, soon after the report of this massacre was received, the Governor and Council sent 90 men under four commanders, one of whom was William Jennison (then an Ensign, but made a captain the next March), in three shallops, with orders to put to death the men of Block Island, but to spare the women and children; then to go and demand satisfaction of the Pequods, and if refused, to enforce it. George Munnings, of Watertown, was one of the volunteers in this expedition, and Oct. 28, 1636, the Court granted to him *£5*, and the fines for a week, "in regard of the loss of his eye, in the country's service in the voyage to Block Island."

§ 165. To carry on this war, Massachusetts agreed the next April 15th, to furnish 160 men, of whom 14 were to be raised in Watertown. Capt. William Jennison, of Watertown, was one of the committee appointed May 17, 1637, "for the present expedition for men, munition, and provisions," for this war, and he was soon after on a committee for apportioning to the several towns an additional levy of 50 men, of whom 4 were to be raised by Watertown. As prompt action was necessary, "the first of the Massachusetts men, that could be raised," consisting of 40 men, were

placed under the command of Capt. Patrick, of Watertown, and their departure hastened. Robert Seeley, a Watertown man, who had moved to Connecticut, not long before, was lieutenant, next in command under Capt. John Mason, in that dreadful fight, which exterminated the Pequot nation.

§ 166. Many of the very early towns (as we have attempted to show in another place, Section 48, 49, &c.), were planted chiefly, or in part, by emigrants from Watertown, and a full history of those towns, as Wethersfield, Lancaster, Groton, &c., &c., would show that Watertown planters and their descendants have not been exempt from a full share of the perils and hardships of a border life, often environed by savage neighbors. The history of no war gives a full record of the slain, and of the sufferings resulting from warfare; more especially would this be the case in wars waged by such foes as the American Indians.

§ 167. Besides the massacres of these early plantations, settled by Watertown people, we have the names of some, who did not migrate from Watertown, but went to aid in the defense of those plantations, and fell a sacrifice to their public spirit. William Flagg, was slain at Lancaster, Aug. 22, 1675. Capt. Richard Beers, was slain, and John Chinery, mortally wounded in battle, at Northfield, September 4, 1675, and in the same month John Ball was slain at Lancaster. In the same year, John Sherman, Jr., son of Capt. John Sherman, fell in the Narraganset fight. In Feb., 1675-6, George Harrington, of Capt. Wadsworth's company, was slain at Lancaster. Upon the attack upon Groton, in March, 1676, 40 Watertown men marched to their relief. At a later day, Serj. Jacob Fulham, of Weston, fell heroically in the renowned fight at Lovewell's Pond, May 8, 1725. Lieut. Gersham Flagg, of Woburn, eldest son of Thomas, of Wat., was slain by Indians, July 6, 1690, at Lamprey River.

EARLY MEETING-HOUSES, CHURCHES, AND MINISTERS.

§ 168. As the first settlers "resolved that they would combine into church-fellowship, as their first work," it is very probable that they very soon constructed a house for public worship. Their number was so great from the first, that they could not all be accommodated in any one of the small hastily built tenements, which they must have first erected. One was certainly built before 1634, as the first transaction in the records, after the distinct civil organization of the town, related to the meeting-house. The records do not show when or where it was situated; but as the residences of Sir Richard Saltonstall, Rev. Mr. Phillips, Elder Richard Browne, and of most of those, who were first admitted freemen, were at the east of Mount Auburn, and as that part of the plantation was then designated "the town," there can be little or no doubt, but that the first meeting-house was built there. On the 7th Aug., 1635 (?36), a rate of £80 was ordered to be levied for "the charges of the new meeting-house," which implies that there was another and older one. It is conjectured that this new one was built on the Meeting-house Common, near the old graveyard. It was provided with a bell as early as Feb., 1648-9, when a bill for a bell-rope was ordered to be paid, and the next September a town rate was levied "to build a gallery in the meeting-house."

§ 169. On the 14th of Oct., 1654, it was ordered that a new meeting-house be built between Serj. Bright's [where Mr. J. P. Cushing now resides], and John Biscoe's [N. W. corner of Belmont and Common Streets], and they agreed with John Sherman to build it by the 1st of Sept. 1656, for £400, with the use of the old seats; and a rate of £150 was then ordered to begin with; and, it was agreed that "Cambridge meeting-house shall be the pattern in all points." There was, however, so much dissatisfaction among the people with that site, that, on the 20th

of the next February, it was "voted that the site of the meeting-house be determined by Mr. Endicote, Capt. Bridges, and Mr. Aderton [? Atherton]." No record of their decision has been discovered, but it probably resulted in the building of it on the Meeting-house Common, on or near the site then occupied, and it is probable that the house was completed about the time stipulated, as on the 7th of November, 1656, an order was passed "to seat the meeting-house," and the rules were: 1st, office; 2d, age; 3d, estate.* A little more than a year afterwards (Jan. 22, 1657-8), it was ordered, that brother [Edmund] Blois, shall have £3, for looking to the meeting-house. It appears that he held this office until his decease; for, on the 24th of May, 1681, the selectmen chose Benjamin Crispe, "in the room of goodman Blois, to take care of the meeting-house, with a salary of £4 10." This continued to be a place of public worship for the whole town, including Waltham and Weston, until after the resignation of Mr. Bailey, when an earnest controversy arose about the inconvenience of the location, which resulted in a division of the church, and the building a meeting-house at the southeast corner of Belmont and Lexington Streets, on the homestall lot originally granted to Rev. John Knowles.

§ 170. Soon after the decease of the Rev. Mr. Angier, the town was divided into two precincts, with a distinct boundary between them, and distinct and independent ecclesiastical organizations. Soon after this each society built new meeting-houses. The western precinct (Mr. Angier's Society), built theirs a little north of Waltham Plain, near the old Livermore homestead, of late known as the Lyman Place; and in 1723, the Eastern Precinct (Mr. Gibbs's Society), built their new meeting-house, 50 ft. long, and 40 ft. wide, on School-house Hill, afterwards known as Meeting-house Hill, and which is the ancient Strawberry Hill. This continued to be the place of worship until 1754, when a new meeting-house was built near the corner of Mount Auburn and Common Streets.

§ † 170. The first church of Watertown was organized July 28, 1630, and, next after that of Salem, is the oldest in the colony of Massachusetts Bay. [See Sections 11-17.] It was the only church in the town for sixty-six years. Rev. George Phillips was the first and the only pastor for more than ten years. It was the first church that adopted strict Independency, or Congregationalism; and, in this respect, for some time, it stood alone, at least until after the arrival of Rev. John Cotton. For a long time it adhered more strictly to Independency than either of the other churches. We may infer this from Mather's account of the organization of the church; from Winthrop's account of the ordination of Mr. Knowles, and from succeeding ordinations. Mr. John Knowles was ordained pastor, Dec. 9th, 1640, as a colleague of Mr. Phillips.† With the exception of an absence of about seven months on a mission to Virginia (Oct. 8, 1642 to June 20, 1643), he continued a pastor of Watertown about ten years. He is said to have sailed to England in 1650, but the precise date has not been ascertained. This was probably a sudden determination, as he was admitted freeman in May of that year. He was, for about three years and a half, a colleague of Mr. Phillips, who d. July 1, 1644. After this event, he was sole pastor about the same length of time; after which, about the close of the year 1647, Rev. John Sherman returned from Milford to Watertown, and became his colleague. [See pp. 432 and 935.] This shows that Mr. Sherman was not the immediate successor of Mr. Phillips, as has been commonly represented. After the departure of Mr. Knowles, Mr. Sherman continued to be the sole pastor until his decease, Aug. 8, 1685.

§ † 171. These three (Phillips, Knowles, and Sherman) were the only pastors of

* There can be little doubt that a new meeting-house was built at this time; as, in addition to the levy of \$150 first ordered, another of £152 16s. 1½d. was ordered Nov. 3, 1656, and the same sum again Dec. 2, 1656, soon after the time stipulated for its completion.

† See Section 16. It is probable that the principles of Independency, imbibed in Watertown, by those who first planted Wethersfield, was the occasion of the early ecclesiastical strife in Connecticut. *It is also to be noticed that the sensible and cogent memorial of Woburn Church, in 1653, against ecclesiastical tyranny, and advocating independency, was signed by several emigrants from Watertown, and that the first subscriber was John Knight, [Mass. Hist. Coll., 3d Ser., I., p. 38.]

Watertown for the first fifty-five years. But, in the meantime, there were several clerical men and ruling-elders residents of the town. It is said [Hist. of Glastenbury, p. 31], that the Rev. Richard Denton came to Watertown in 1634, and the next year went to Wethersfield. This is not improbable, although no confirmation of it is found in the Watertown or Mass. Colonial Records. Rev. John Sherman, before mentioned, came over in 1634, and resided in Watertown until he was dismissed from Watertown Church to Wethersfield in May, 1635. Mather says that, on a thanksgiving-day in Watertown, "Mr. Sherman preached his first sermon as an assistant to Mr. Phillips," in the presence of "many other divines," who "wondered exceedingly" at this early display of his ability. He resided in Connecticut about twelve years and a half. In 1636, Mr. Ralph Wheelock and Mr. Henry Phillips went from Watertown to Dedham, with the early planters thereof, as candidates for teacher (*i. e.* for the ministry). Whether they ever preached in Watertown, the records do not show. Neither of them obtained the pastorate at Dedham. Mr. Wheelock engaged in official civil life in Dedham; afterwards resided in Medfield. It is probable that Mr. H. Phillips also renounced the clerical profession. Between 1637 and 1642, Mr. Thomas Carter and Mr. Henry Greene settled in Watertown, and received grants of land. In the lists of possessions, they are both styled Elders. Mr. Carter was an officer of Watertown Church, and, as an Elder, with Elder Edward How, signed the dismissal of members to Dedham Church. He was ordained the first minister of Woburn, Nov. 22, 1642. Mr. Green was ordained the first minister of Reading, Nov. 5, 1645. [See pp. 261 and 776.]

§ 171. We have not discovered any notice of more than two lay Ruling Elders of Watertown. Mr. Richard Browne had been an officer in a Church of Separatists in London, and was an Elder of Watertown Church at its first organization. He had undoubtedly much influence in causing the church to assume strict Independency. He was dismissed from the office of Elder in 1632, through the influence and instigation of those magistrates and others who were devising and imposing that politico-ecclesiastical domination, which has been so reproachful to that colony; and it is probable that their persecution of him should be attributed quite as much to his bold advocacy of ecclesiastical independency, and his opposition to taxation without representation, as to his ideas of Popery. [See Richard Browne, pp. †122-4.] Mr. Edward How, who died in 1644, very near the time of Mr. Phillips's decease, was an Elder for several years; but the records do not show the date of his election. After his decease, the only officers in the church appear to have been pastors and deacons. The distinction between pastor and teacher was never recognized in Watertown. The town records mention together the two pastors, Knowles and Sherman, giving precedence to the former. Winthrop [II. p. 18] noticing the ordination of Mr. Knowles, Dec. 9, 1640, three years and a half before the decease of Mr. Phillips, says, "The Church of Watertown ordained Mr. Knowles, a good man and a prime scholar, *pastor*, and so they had now two pastors and no teacher, differing from the practice of the other churches, as also they did in their privacy [private, exclusive manner], not giving notice thereof to the neighboring churches, nor to the magistrates, as the common practice was." The church, in this instance, clearly evinced their principles of strict Independency. They had the stronger reason for adhering to these principles, after the intermeddling of the magistrates and others in the case of their worthy Elder, Mr. Browne.

§ 172. From the preceding statement, it may be seen that the Rev. Mr. Sherman continued the sole pastor of the church almost thirty-five years after the departure of Mr. Knowles for England. There are no church records of that period extant, and we know little of the condition or doings of the church during that time, except the little that may be obtained incidentally from other sources. From the silence of the town records, we may infer that there was peace and harmony.

§ 173. Oct. 12, 1674, ten years before the decease of Mr. Sherman, the town voted to "desire Mr. Thomas Clark to be helpful of Mr. Sherman in preaching;"

and on the 15th of June, 1685, two months before his decease, the town "voted to treat with Mr. [John] Bailey to help the minister." On the 24th of August, it was "voted that the town would defray the charge of our Reverant Pastor Sherman's funeral;" and, at the same time, appointed a committee [Capt. Sherman, Father Coolidge, Deacon Bright, and Simon Stone] to apply to Mr. Bailey. On Nov. 2, 1685, the town voted a rate of £80 for Mr. Bailey, "the year to begin Aug. 24, 1685." It appears that he did not accede to the proposal; and, on June 8, 1686, the town appointed a committee "to request Mr. Bailey, the elder, to appoint an interview." At an adjourned meeting, June 20th, "the Reverant Mr. Bailey being present amongst us, and declaring himself ready to come amongst us, in order to continuing with us, if peace and love continueth amongst us, and we make his life comfortable. The town declared, by a vote, their acceptance of his answer, and doe desire that ceare be taken to fetch him up, as soon as may be with convenieny; and do deziere to do thear utmost to satisfy his desyre." The stipulations, or bargain, between the parties, do not seem to have been determined until about the end of August.

§ 174. Mr. Bailey was installed, Oct. 6, 1686. This is said to be the first instance, or one of the first, of an installation in the colony. The early Congregational Churches of New England did not generally regard ordination as a ceremony or sacrament for admitting men into the clerical order, or caste, but a process for inducting them into office, and investing them with the powers pertaining to it. Their views were, that election to office, by a church, or company of believers, must precede ordination; that whatever power or privilege was conferred by ordination lasted no longer than the connection of the minister with the church over which he had been ordained; and that, if he took charge of another church as pastor, he must be inducted into office by another ordination. Mr. Bailey had been a minister for some time in Ireland, where he had probably imbibed Presbyterian views of ordination; and when he was settled in Watertown, he was installed in office without ordination. In his journal, he says, "I was solemnly set apart for the pastoral work at Watertown; *without the imposition of hands.*" [See the elaborate and learned notes of Rev. Samuel Sewall, Am. Quart. Reg., XIII., p. 48, "Mr. Phillips," and p. 56, "Installation."]

§ 175. At a town meeting, Nov. 1, 1686, about three weeks after the installation of Mr. John Bailey, it was "voted with a very full vote that the town did still earnestly desire that they might enjoy Mr. [Thomas] Bailey, the younger, to be helpful to his brother in the ministry." He did not immediately comply with this desire; for, on the 27th Sept., 1687, it was "voted to fetch up Rev. Thomas Bailey at the charge of the town," and, on the 7th of November, it was voted that "Rev. Thomas Bailey's £60 shall begin the same day he came to dwell among us, 2 Nov., 1687, with house-room and firing." The town records furnish no evidence that he was ever ordained or installed in Watertown. He d., Jan. 21, 1688-9, after a residence in Watertown of a little more than fourteen months.

§ 176. Mr. John Bailey returned to Boston, in 1692, but it is probable that he attended very little to pastoral duties after the summer of 1690. His health was feeble, his disposition affectionate, and his temperament nervous and desponding. His brother Thomas d. in Jan., 1689, and his wife died in April, 1690. Th's last bereavement seems to have greatly depressed him. In his church record, Ap. 12, 1690, after recording some admissions to the church, he adds, "I meant to have said something here farther as to it [delay to join the church], but Lyddy is dead, and I feel entirely indisposed to everything." The last time he admitted any to the church was August 3, 1690, and at the end of the record, he says, "A sad week of temptation, I had before [this], having but few in the church to help me, and encourage me; but God carried me through." The last time he officiated at a marriage in Watertown, was Mar. 6, 1690-1, and the last baptism was performed May 31, 1691. It is probable that he attended very little, if any, to pastoral duties after this date.

§ 177. In the church records, Ap. 27, 1690, Mr. Bailey says, "I admitted [to the church] Mr. Henry Gibbs, who has sometimes preached for me, and now this quarter of a year has lived with me." This probably indicates about what time Mr. Gibbs first went to Watertown. Oct. 14, 1690, the town voted "to make choice of a *help* to carry on the work of the ministry amongst us, *in this, our great want.*" This implies that Mr. Bailey still retained his pastoral relation, but was unable to fulfil its duties. At the same time it was voted "to treat with Mr. Henry Gibbs;" and to give him £40. At a town meeting, Nov. 3, 1690, Capt. Sherman, Lieut. Bond, and the deacons, reported Mr. Gibbs's answer, "that he looketh upon it as a call from God, that he hath inclined the town to be so unanimous in their calling of him, and, therefore, is willing to attend to the said work as God shall enable him." The town accepted the answer, and voted that his salary began this day. This appears to have been a call to Mr. Gibbs to be an assistant to Mr. Bailey, and not to be a pastor. At a town meeting, a year later, Nov. 16, 1691, a committee [Mr. Bond, Capt. Warren, and Simon Stone], was chosen "to treat with Rev. Henry Gibbs, and Mr. Bailey to be helpful," &c. A week later, Nov. 23d, it was voted that "said committee shall now, *in the time of our vacancy*, provide help for the town, and defray the charge out of the £60 salary;" and that the balance in the hands of Bond and Jennison, "should be given to the Rev. Mr. Cosson" [Cotton]. Dec. 28, 1691, the selectmen directed rates for the two ministers—Mr. Bailey's, but three-quarters of the year to be collected. The circumstances and proceedings here referred to render it very probable, that Mr. Bailey ceased to perform pastoral duties in the summer of 1691, not long after the performance of the last baptism. As he was settled in October, at which time his salary began, the three-quarters of the year above mentioned would terminate in July. It was not an uncommon thing for towns to be in arrears in the payment of ministers. This may have been the case here, and Mr. Bailey may have remained in the town until the rate was collected, and the arrearage paid. His pastorship in Watertown, lasted a little less than five years, and during that time he admitted 116 to the church, performed 347 baptisms, and officiated at 39 marriages.

§ 178. Notwithstanding the inconvenience many of the people labored under, on account of their remoteness from the meeting-house, which was then situated towards the eastern border, far from the centre of the territory, and of the population of the town, the town records do not indicate that there was any serious strife on that account, until 1692, after Mr. Bailey returned to Boston. Yet, the Report [the advice and determination] of the Committee of the Council, to whom the points in dispute were referred, say, "there has been of a long time, even ever since the days of your blessed pastor Phillips, an earnest contending about the place of meeting." That its removal had been generally and confidently expected, for several years, is evident from the following vote, passed at a town meeting, Feb. 12, 1685-6, previous to the settlement of Mr. Bailey. "Agreed, the town would hire of any, who should build a house for the minister, *until the meeting-house was removed, or another one built elsewhere.*" In 1685, soon after the decease of Rev. Mr. Sherman, the farmers presented a petition, which is not recorded, but the purport of which may be inferred from the following vote, passed by the town Nov. 10, 1685. "Voted that the farmers' petition should be suspended, as to an answer to it, until it pleaseth God to settle a minister amongst us." They had probably asked to be exempted from taxation for the support of a ministry, which they could not attend on account of their remoteness. But that contentious spirit is not evinced, which afterwards prevailed. It appears from the record of the organization of the church of the Farmers' Precinct [Weston], that a considerable number of the members had belonged to the Church of Sudbury, whose meeting-house was much nearer to them than that of Watertown. Even as early as 1650 or '51, this remoteness from the meeting-house is referred to by Johnson [Wond. Work. Prov. chap. xxxiii.], who, speaking of "this great town, consisting of 160 families," calls it "a fruitful plat, of large

extent, watered with many pleasant springs, and small rivulets, running like veins throughout her body, *which hath caused her inhabitants to scatter in such a manner, that their Sabbath-assemblies prove very thin, if the season favor not.*"

§ 179. In 1692, an exciting controversy arose in the town about the location of the meeting-house, which then stood not far from the old graveyard.

At a town meeting Nov. 18, 1692, in order to determine the location of the meeting-house, it was ordered that "those who are of the mind to build and set up a meeting-house on the hill between the Pound and Widow Whitney's, let them follow Robert Harrington, Sen.; those that are of the mind to build it where it is, let them follow Mr. Norcross," and, "in case we can't agree among ourselves, we will refer it to men." It appears that they did not agree, and on the 7th of December, the selectmen appointed Robert Harrington, Daniel Warren, Sen., and Isaac Mixer, Sen., to petition Gov. Phipps and the Council concerning the meeting-house. A town meeting, summoned by the Council, was held Dec. 27, 1692, at which were present the Lieut. Governor, Major Phillips, Esq., Mr. Suel [Samuel Sewall], Esq., Capt. Lines [Lynde], Esq. It was then voted 1st, "that matters of difference in Watertown, relating to the settling a minister and the placing the meeting-house is referred to a committee." 2d, "that we do pray the Governor and Council to choose a committee, and that we will set down by the determination of that committee in reference to matters aforesaid." 3d, "that we do so desire and appoint Mr. William Bond, and Lieut. Benjamin Garfield, to apply themselves to the Governor and Council for the obtaining a committee for the ends above said." The selectmen received notice, Mar. 9, 1692-3, of a meeting to be held at Capt. Sewell's, in Boston, the next Thursday at 9 A. M., "concerning the meeting-house," which meeting was adjourned to the 23d. The following is the "return" of the Council, dated Boston, May 18, 1693. "Whereas, there has been of a long time, even ever since the days of your blessed pastor Phillips, an earnest contending about the place of meeting for the public worship of God. Having heard and duly weighed the allegations of both parties, in your public meeting, and considering the remoteness of the most of your inhabitants, from the place where the meeting-house now stands. Our advice and determination in that matter is, that within the space of four years next coming, there be a meeting-house erected in your town on a knoll of ground lying between the house of Widow Stearns, and Whitney's Hill; to be the place of meeting to worship God for the whole town. And if in the mean time the minister see cause to dwell in the house where the Reverend Mr. John Baily dwell'd, the town pay rent to the proprietors, as hath been accustomed since its building. So praying to unite your hearts in his fear, we take leave, who are your truly loving friends and brethren."

[Signed], "Wm. Stoughton, John Phillips, Jas. Russell, Sam. Sewall, Joseph Lynde." [Addressed], "To our Brethren and Neighbors of Watertown."

§ 180. Ap. 17, 1694, the selectmen called a town meeting, to be held on the 9th of May, one object of which was "to consider of the charge of building a new meeting-house, and to see to the performance thereof," in conformity with the determination of the Council. At that town meeting was presented an earnest protest against a compliance with the decision of the Council, "because the town, nor any part, never desired any gentlemen to say where we should build a meeting-house, nor when; and we do absolutely deny ever to pay one penny towards any such building at that place; but if the town shall see cause to erect a place of meeting, for the public worship of God, at the westward part of our town, so as it may be convenient, where the farmers, with such others that way as will be pleased to join with them, shall think convenient, we shall be willing to be helpful therein, as much as may be thought necessary," &c. This protest was signed by eighty-two men and women residing in the eastern part of the town, and by thirty-three men and women residing at the western part of the town, in the farms.

§ 181. The majority of the town were in favor of compliance with the advice and determination of the Council, and they elected selectmen, who, at least a majority of them, were of the same views. But the opposition of the other party, belonging to the east part of the town, was very fierce and acrimonious. At a town meeting, held Oct. 2, 1694, the contention was so great that the Moderator, Daniel Warren, Sen., did, by advice, adjourn the meeting, "to prevent such inconvenience as might justly be feared by reason of the heat of spirit that then seemed to prevail." The contentious party immediately, through a constable of their party, appointed Simon Stone moderator, and passed some votes, against which the selectmen afterwards entered their dissent as irregular and not valid, and ordered their protest to be entered in the records. A counter-dissent was entered for the other party by Ebenezer Prout, then Town Clerk, which the selectmen soon after (Mar. 15, 1694-5) declared was entered without their knowledge and order [for] it to be recorded. It was at that irregular and riotous town meeting, that the vote was passed to make Beaver Brook the eastern boundary of the Farmers' Precinct. [See § 38.]

§ 182. Notwithstanding this opposition, on the 7th of Mar., 1694-5, a levy for building a meeting-house was ordered, at 4*d.* per pound, amounting to £320 4.* The house was built without delay, for a town meeting was held, "at the new meeting-house," Dec. 20, 1695. It was built on the southeast angle of the cross roads, at the crossing of Lexington and Belmont Sts. At a town meeting, the next February, it was voted to accept the new meeting-house. At the town meeting in Dec., a committee (Capt. Warren, Isaac Mixer, Sen., and B. Garfield) were appointed to treat with the Rev. Henry Gibbs. In his reply, dated Feb. 4, 1695-6, he says: "Being sensible that there is a great dissatisfaction in the town [the eastern part of it], with reference to that meeting those votes were passed [appointing a committee to treat with him], I fear it might prove uncomfortable, should I express my compliance therewith; and so, accordingly, I am advised to decline the matter till such time as care be taken to remove the said dissatisfaction, not doubting but that this being effected, which I earnestly pray that God would in his own time grant, it would much conduce to our comfort and advantage." After receiving this reply "to the town, the town applied themselves to him again, but he refusing, then they were to apply to some other minister to preach in the New Meeting-house;" but "Mr. Gibbs to have the first proffer." At a town meeting, Mar. 12, 1695-6, it was voted that only one-fourth of the rate be paid to Mr. Gibbs, and three-fourths of it "to be paid to the preachers appointed by the town to preach in the New House." At the same time, it was "voted, that the town will be at [assume] the charge of building the New Meeting-house, that is set up in the place appointed by the Honored Committee, bearing date May 18, 1693." Also, "voted, that the New Meeting-house shall be the place for all publick town meetings for the future, by reason it is most in the center." At a town meeting, March 24th, it was reported by the committee appointed to treat with Mr. Gibbs that "he refused to preach even so much as one day." There appears to have been no farther application to Mr. Gibbs, who seems to have sympathized with what might be called the eastern faction. At a town meeting, June 26th, 1696, it was, "1st, Voted that there should be a day of humiliation kept in Watertown, the time and place to be appointed by the reverend elders. 2d, That Simon Stone, Capt. Barsham, Isaac Mixer, and Benjamin Garfield, are desired and appointed to entreat the Rev. Mr. Samuel Willard and Rev. Mr. Cotton Mather to carry on the work of the day of humiliation, and to appoint the time and place of meeting."

§ 183. The records do not, I think, show the result of this application; but the selectmen were notified that, on the 28th of August, 1696, "the church chose Mr. Angier to preach, and they warned a town meeting to be held on the 21st of September." At this meeting, "each party chose three persons to represent them in a

* This shows that the assessed valuation of the town, including Waltham and Weston, was, at this time, £19,212.

debate with those of the middle part of the town." The east end chose Capt. Barsham, Simon Stone, and Joseph Sherman, to represent them, and the middle part chose Jonathan Sanderson, Philip Shattuck, and Benjamin Garfield, "to debate those matters of difference that did keep them from uniting in love and peace, as to the worship of God." The "proceedings of that meeting were then suspended," *i. e.* adjourned, to Sept. 28th. At this meeting, Benjamin Garfield, the Town Clerk, "did relate to the town the proposals made by both parties, which are as followeth. Those of the east part of the town were :

"1st. To have two congregations, and a rate made by the town for their maintenance of both the m[in]isters, and so the people be at liberty to go to which meeting-house they would.

"2d. Or to come to the old meeting-house again.

"3d. Or to draw lots which should be the meeting-house of the town.

"The answer of the middle part of the town are [is] as followeth: First, That two congregations would not be convenient, because if we should be in two congregations it is much to be feared we should be two in spirit; which, by too long experience, we know would be very unreasonable, having built [a meeting-house] in a place for the whole town. 3d [proposition]. As to draw lots for which place to meet in would be altogether inconvenient, because the town did refer it to a committee, which we count is a lot in that matter; therefore we would make some propositions to you [to meet the three made by the other party]. 1st. There be a general assessment for building Mr. Gibbs's house, repairing the old, and building new meeting-house. 2d. Because the new house is most convenient to meet in. 3d. If the east end desire Mr. Gibbs should be first put in vote to vote for, it shall be so; and if there be a major part vote for him, we will comply with it—to preach in the new house. 4th. If Mr. Gibbs hath not a major vote, we will put Mr. Angier to vote. 5th. It was offered to the east end to have both ministers, and to have [no] further debates. 6th. Or [if there is to be further debate] to have moderators. So (at this same meeting, Sept. 28, 1696) "after all this debating, the town concurred with the church in calling Mr. Angier to preach in the new meeting-house." On the 21st Dec., the town voted £70, as a salary for Mr. Angier, with house-room and firewood, the year to begin this day. At the same time, a committee was appointed "to procure housing for Mr. Angier, and to bring him and family to Watertown." Mr. Angier was ordained May 25, 1697. The first baptism by him was June 20th; the first admission to the church, Oct. 10, 1697; and the first marriage by him, Jan. 3, 1697-8. At a town meeting, May 21st, voted, "continued concurrence in Mr. Angier's choice." At a town meeting of the two precincts, orderly warned, July 2, 1697, it was voted that a committee (Capt. John Warren, Deacon Cook, Lieut. Nathaniel Bond, Lieut. Jonas Bond, and Samuel Eddy) be appointed "to treat with Rev. Mr. Gibbs to assist Rev. Mr. Angier," and "to pay him £65, &c., if he accepts."

"The Reverend Mr. Angier, being informed of Mr. Gibbs's call, hath showed his concurrence as followeth :

"I having been informed of a late vote of the inhabitants, for the inviting Mr. Henry Gibbs to preach in the new meeting-house, I do hereby signify my good liking and approbation of Mr. Gibbs his being joined with me in the work of the ministry for the church and town in the new meeting-house.

[Signed]

"SAML. ANGIER."

§ 184. Mr. Gibbs did not accept this offer. He had been preaching in the old meeting-house most of the time for nearly seven years, and his sympathies and attachments seem to have pertained to the people of the east end, where a church was organized very soon after the settlement of Mr. Angier, and where Mr. Gibbs was ordained Oct. 6, 1697. The first baptism was performed by him Nov. 7th, and the first marriage, Dec. 17, 1697.

§ 185. In the course of this controversy, the people at the middle part of the town seem to have been the most reasonable and liberal; but they did not evince this upon the ordination of Mr. Gibbs. Judge Sewall [diary] says, the ordination of Mr. Gibbs "was done in the afternoon in the open air, though a cold day. The western party, having the selectmen on their side, got possession of the meeting-house, and would not suffer the assembly to enter there."

§ 186. It may fairly be questioned which of the two was entitled to the distinction of being the first church; that is, whether that of Watertown or that of Waltham has the best claim to be the direct descendant of that church which was organized by Mr. Phillips. Mr. Angier was elected and settled by a majority of the votes of the church and of the town, and he was then the only minister of the town. His society, or a majority of them, afterwards became the Church of Waltham. Mr. Gibbs, at his settlement, was neither elected nor settled by a vote of the town, but by the party at the east end. But his society occupied the old meeting-house; the church records; kept by Mr. Bailey, passed into his hands; and when the town was divided into two precincts, Mr. Angier's society, after his decease, built their meeting-house in the West Precinct [Waltham], near the old Nathaniel Livermore homestead, while the society which settled Mr. Gibbs, embraced the whole of the Eastern Precinct [Watertown], and a large number of those families who at first belonged to Mr. Angier's society. Moreover, the church records of Waltham extend no farther back than those kept by Mr. Angier.

§ 187. The salaries of Mr. Angier and Mr. Gibbs were for a long time paid out of the town treasury; but there arose a controversy between the two societies about the expenses of building and repairing the meeting-houses. The subject was referred to Court. The advice, or report, was not acceptable to a majority. It is probable that the ground of the controversy was that the Western (Mr. Angier's) Society had a majority of the voters in the town, that the Eastern (Mr. Gibbs's) Society had the most wealth, and paid the most taxes, and that the expenses of Mr. Angier's Society were paid in part by taxes levied on those that did not belong to it. The controversy continued until after the decease of Mr. Angier. Nov. 19, 1720, the General Court appointed a committee to assign a boundary line between the two precincts. They made their report in December, which was accepted by the town, and Samuel Phaxter, Esq., was ordered to run the line. This committee likewise decided that, within two years, the new or West Meeting-house should be removed near the house of Nathaniel Livermore, a little distance northwest of the mansion of Geo. W. Lyman, Esq., and that within ten years the old or East Meeting-house should be removed to School-house Hill. [See pp. 955 and 6.] Mr. Angier's successors have been Rev. Warham Williams, Rev. Dr. Jacob Cushing, Rev. Mr. Ripley, &c., and the successors of Mr. Gibbs have been Rev. Seth Storer, Rev. Daniel Adams, Rev. Richard R. Elliott, Rev. Dr. Convers Francis, Rev. John Weiss, &c. See the earlier of these names in this work. For a more copious account of Watertown Church, see Dr. Francis's history of the town.

§ 188. The first settlers of the Farms were so remote from the meeting-house (from 5 to 8 miles distant) that many of them attended the meeting in Sudbury, yet they were taxed for the support of the ministry in Watertown. At a town meeting Nov. 10, 1685, three months after the decease of the Rev. Mr. Sherman, it was "Voted, that the Farmers' petition should be suspended as to an answer unto it, till it pleaseth God to settle a minister amongst us." The petition is not recorded; but there is good reason to believe that it was, to be exempted from taxation for the support of a ministry which they could not attend. There is no further reference to this subject in the records until Oct. 2, 1694, where it appears that "Our neighbors, the Farmers, were upon endeavors to have a meeting-house amongst themselves." The next January they agreed to build a meeting-house thirty feet square, and to place it on land of Nathaniel Coolidge, Sen., by the side of the road, at the head of

Parkhurst's meadow, a little in front of the present meeting-house. The next year agents were chosen to contract with workmen to build the Farmers' Meeting-house. Votes were passed in 1698, 1699, by the precinct for completing the meeting-house, which, notwithstanding its smallness, was not so far finished, as to be occupied until Mar. 1700. It was begun by subscription and afterwards carried on at the expense of the precinct.

§ 189. At a precinct meeting held Oct. 8, 1700, for the choice of a minister, in order for settlement, Mr. Thomas Symmes, was chosen, but did not accept. Soon after a similar call was given to Mr. Joseph Moree, and on the 6th July, 1702, by a vote of 30 to 12, they gave him a call to settle in the ministry. The next year they built him a house 40 ft. by 20, and he gathered a congregation, but the next year (1704), difficulties arose, so that a church was not organized, and he was not settled [see p. 374]. Feb. 11, 1707, the precinct chose Mr. Nathaniel Gookin, to be their minister. He did not accept; and on July 16, 1707, they chose Mr. Thomas Tufts, who declined the call. Feb. 4, 1708, they gave a call to Mr. William Williams, to settle in the ministry [see p. 654]. He accepted, a church was gathered and organized, and he was ordained Nov. 2, 1709. He was pastor of the church about 41 years, and was succeeded by Rev. Samuel Woodward, who was ordained Sept. 25, 1751 [see p. 664]. He d. Oct. 5, 1782, and was succeeded by his son-in-law, Rev. Dr. Samuel Kendall, who was ordained Nov. 5, 1788 [see pp. 325 and 665]. He d. 1814, and was succeeded by Rev. Dr. Joseph Field [see p. 207]. For more full information respecting this church, see the very valuable centennial Discourse of Samuel Kendall, D.D.

MILITARY MEN AND AFFAIRS.

§ 190. Few of the first settlers* knew much of the military art, or were able to teach it; but it was necessary that every man should be trained to the best means and mode of defence against the hostile attacks to which they were so liable. The government, perceiving this necessity, immediately provided for it. The first recorded transaction of the Governor and Assistants, after their arrival, having reference to military or defensive measures, was at their second meeting, Sept. 7, 1630, when provision was made for the annual support of Capt. Daniel Patrick, of Watertown, and Capt. John Underhill, of Boston. The former had been a soldier in the Prince's Guard in Holland, and probably both of them had been trained and habituated to a military life. They continued to be supported at the public expense for seven years. They were not merely militia or trainband captains, who had to turn out at stated times with the soldiers of the town, where they resided, nor were their duties limited to those towns. They were the military disciplinarians or professors of the colony.

§ 191. There does not appear to have been any general military organization of the colony, until about the close of 1636, in the time of the Pequot war. It is probable that, for the first few years, Capt. Underhill had the training of the soldiers on the south side of Charles River,—those of Boston, Roxbury, and Dorchester; and that Capt. Patrick had the training of those on the north side of the river,—those of Charlestown, Watertown, New Town, and Medford, exclusive of those in and about Salem. In Dec., 1636, all those in the colony, able and liable to do military duty, were ranked in three regiments, as follows:

1. The South (Suffolk) Regiment, of which John Winthrop, Sen., was Colonel;

* Among those who arrived a few years later, there was probably a considerable number, who had some skill and experience in military discipline. It is said that several of them had belonged to the Honorable Artillery Company, of London.

Thomas Dudley, Lieut. Colonel; and Capt. John Underhill, Muster-master. It included the towns of Boston, Roxbury, Dorchester, Weymouth, and Hingham.

2. The North (Middlesex) Regiment, of which John Haines, was Colonel; Roger Harlakenden, Lieut. Colonel; and Capt. Daniel Patrick, Muster-master. It included the towns of Charlestown, New Town (Cambridge), Watertown, Concord, and Dedham.

3. The East (Essex) Regiment, of which John Endicott, was Colonel; John Winthrop, Jr., Lieut. Colonel; and Capt. William Trask, Master-muster. It included the towns of Salem, Saugus (Lynn), Ipswich, and Newbury.

§ 192. At the Court in the succeeding March, captains, and in some instances lieutenants and ensigns, were appointed for the trainbands of most of the towns. But on the same day (Mar. 9, 1636-7), the Court appointed "Mr. John Underhill, and Mr. Daniel Patrick, captains for the country's service, for which they are to have £30 apiece yearly out of the treasury, and to be disposed by order of the Council of War." At this time Capt. Patrick, although belonging to Watertown, and holding the above-mentioned appointment, did not continue to command the Watertown trainband, to which office Mr. William Jennison was now appointed. The next Nov. (1637), Captains Underhill and Patrick were by the Court discharged from any other service ["for the country"], and a gratuity of one quarter's pay was made to each of them. It does not appear that any successors were appointed, sustaining the same relation to the government, as they had done, and their office became obsolete.

§ 193. Their duties seem to have been to train and prepare the people for military service, to hold themselves always in readiness for the "Orders of the Council of War," and, perhaps, to act as the military advisers of the government. It is probable that experience in the Pequot war, had shown that the tactics and discipline of a Prince's Guard were not the best preparation for efficient service in Indian warfare, and that this led to the dismissal of Captains Patrick and Underhill, and to the abolition of their peculiar office. It is to be observed, that at this precise time commenced that association of gentlemen, as a military company, which was incorporated Mar. 13, 1638-9, and which, at first sometimes designated as the *First*, or the *Great Artillery Company*, has long been known as *The Ancient and Honorable Artillery Company*. As this company was formed and incorporated for "the advancement of the military art, and exercise of arms," it may have been regarded as a substitute for the office and services of Captains Patrick and Underhill, and have led to their dismissal. In Nov., 1637, at the same time that he was dismissed from office, Patrick obtained permission to move to Ipswich. He, however, remained in Watertown, as he was elected selectman Dec. 30, 1637, and the next October (1638), he was appointed on a committee for laying out the farm lands. Soon after this, Captains Patrick and Underhill, both moved to Connecticut, and Patrick was murdered by a Dutchman, in Underhill's house, at Stamford, in 1643.

§ 194. The information respecting the early organization of the Watertown trainband is very scanty and obscure. Neither the town nor colonial records, so far as has been discovered, show at what age young men were enrolled in the trainbands; but as all above the age of sixteen years were required to take the oath of fidelity [Colonial Records, I. p. 139], that was probably the age when they became liable to military service. Nor was there any legal limit of old age which exempted from it. In the County Court records, there are many instances where men in advanced age were exempted from military trainings, by the Court or magistrates, on account of their infirmities. It will be seen below that it was not unusual for men to receive military appointments, or advancement in rank, in advanced age, and they seemed never to arrive at too great an age to hold them. It is, however, not improbable that some, who held subaltern offices in early life, continued to bear the title long after they ceased to hold the office.

§ 195. It appears from the colonial records, that the soldiers of Charlestown and Watertown were for some time trained together; for, in Sept., 1635, by the Court,

it was "agreed that Charlestown and Watertown shall be distinct companies, and to have officers of their own." As Charlestown and Watertown were not then contiguous, being separated by the interposition of New Town [Cambridge], it would seem very unnatural that the two former should be thus combined, and that New Town should have a distinct trainband. Although New Town is not mentioned in that order of the Court, we conjecture that, previous to that time, the soldiers of those three towns were trained together, and that, when the order was passed "that Charlestown and Watertown shall be two distinct companies," it meant distinct from New Town. It appears by an order of Court, passed Sept. 8, 1634, a year before the passage of the above-mentioned order, that trainband companies sometimes "consisted of two or more towns," and it is probable that, until 1635, the soldiers of Watertown, New Town, and Charlestown, constituted one company, and were trained by Capt. Patrick. It is to be observed that, in 1631, Mr. Jennison was, by the Court, chosen "Ancient [Ensign] to Capt. Patrick," not for Watertown; and the next year, after Capt. Patrick moved temporarily to New Town, Mr. Robert Feake was chosen "Lieutenant to Capt. Patrick," not for Watertown; but that after the passage of the order for distinct companies in Watertown and Charlestown, such appointments were made for towns specified. It is also to be observed, that, when that order was passed, Charlestown, Watertown, and New Town, were the only towns then organized, which were soon afterwards embraced in the Middlesex Regiment, of which Capt. Patrick was Mustermaster; for the date of the order is the same as that of the orders for planting Concord and Dedham. The colonial records do not, I think, show that any captain was appointed for either Charlestown or New Town until after the passage of that order; and as military officers were chosen by the Court, it is presumable that they would be found on record, if any such appointments had been made. It has been already shown that Capt. Patrick was not merely a trainband captain appointed for Watertown. The first choice of trainband captains, for either of those three towns, was made Mar. 9, 1636-7, when Mr. Robert Sedgwick was chosen for Charlestown, Mr. William Jennison for Watertown, and Mr. George Cooke for New Town. This was about eighteen months after the passage of the order for distinct companies in Watertown and Charlestown, and only three months after the order for organizing all the soldiers of the colony into three regiments. Perhaps it may be found that the order for distinct companies was not immediately carried into effect, and that Patrick continued to command the soldiers of the three towns, until the Court chose those three captains.

§ 196. After Captain Patrick, the earliest military appointment by the Court of a Watertown man was Aug. 16, 1631, when "Mr. William Jennison is chosen Ancient [Ensign] to Captain Patrick." He retained this office until Mar. 1636-7, when he was chosen Captain of the trainband, and held the office until his return to England. On the 25th Sept., 1636, soon after information was received of the murder of Mr. Oldham, the Governor and Council "did send forth ninety men, distributed to four commanders—Capt. John Underhill, Capt. Nathaniel Turner, Ensign Jennison, and Ensign Davenport"—in order to "do justice upon the Indians for the murder of Mr. Oldham." [Winthrop, I. p. 192.] George Munnings, of Watertown, in this expedition, lost one of his eyes.

§ 197. The next year (Ap. 18, 1637), when the Court determined that the war against the Pequots "should be seriously prosecuted," and that one hundred and sixty men should be drafted out of the several towns in the colony, Watertown was at first required to furnish fourteen men. May 17th, fifty additional men were ordered to be drafted, and Capt. Jennison was one of the committee for apportioning them among the several towns. The quota of Watertown was four men. At the same time a committee (Capt. Trask, Capt. Jennison, Capt. Turner, Sergt. Richard Collicot) was "appointed for the present expedition for men, munition, and provisions." Also, at the same time, Lieut. Howe was ordered "to go Lieutenant to Capt. Patrick."

§ † 197. On the 4th of Sept., 1632, Mr. Robert Feake was, by the Court, chosen "into the place of Lieutenant to Capt. Patrick." He attained no higher rank, and in March, 1636-7, was superseded by the election of Capt. Jennison. In Sept., 1634, he was one of the military committee appointed by the Court to select sites and lay out the works for fortifications at Castle Island, Charlestown, and Dorchester. About 1639 or '40, he went to Connecticut and was connected with Capt. Patrick in the purchase of Greenwich. He became impoverished, returned to Watertown, and died in indigence. When John Stickland was admitted freeman, in May, 1631, he had the title of Sergeant. Thomas Cakebread had the title of Ensign, and was an original member (in 1637) of the Ancient and Honorable Artillery Company, and in its records has the title of Ensign. Upon the first settlement of Dedham, "an invitation was sent to Thomas Cakebread, a renowned soldier of Watertown, to come and be at the head of military affairs." [Haven's Centennial Address, p. 12.] In Sept., 1642, after the return of Mr. B. Pendleton from Sudbury to Watertown, "Ensign Cakebread was appointed to lead the company at Sudbury as Ensign." The records do not show that either Stickland or Cakebread held offices in Watertown.

§ 198. It is stated on page 402, that Mr. Bryan Pendleton was a captain in Watertown, and Farmer says, he was "a captain of the militia;" but no evidence has been discovered that he held any military office, or title in Watertown. It may be supposed that he first gained the title by commanding the trainband of Sudbury during the short time he resided there. But when he was, by the Court, appointed to that duty (May, 1640), no military title was given to him; and it is not probable that he held any higher title than his successor. Although his name often occurs in the town and colonial records, no military title is attached to it until 1657, several years after he moved from Watertown to Portsmouth. He was a captain there at first, and afterwards attained the rank of major.

Henry Bright was appointed surveyor of arms in Watertown, and took the oath of office in July, 1640. In the town records he had sometimes, and, for a long time bore, the title of sergeant. He appears never to have advanced beyond that title, and he bore it until 1664, then aged 62, after which he bore the title of Deacon. John Wincoll was a sergeant in Watertown, and attained no higher title, until he left the town, about 1662, when he must have been at least 54 years old. After he moved to Kittery, he was elected captain.

§ 199. In May, 1645, the Court ordered, "that in the entry of Watertown officers, [Hugh] Mason should be put in instead of [Thomas] Bartlett," who afterwards, and until his decease, bore the title of Ensign. This appointment of Mason was made about the time Capt. Jennison returned to England, and Mason probably commanded the trainband, with the rank of lieutenant, until May 1652, when he attained the rank of captain. He probably held the office until about the time of his decease (1678), then aged 73, as no other one attained that rank in the town until that time.

§ 200. Richard Beers is first mentioned as a sergeant in 1642, when the Court appointed him to superintend "the breeding of saltpetre" in Watertown. He attained the rank of Lieutenant, soon after Mason was chosen Captain. He bears the same title in the town records until 1675, and he is never mentioned with the title of Captain until the record of his death, Sept. 4, 1675, which was more than 38 years after he had been admitted freeman. He was not less than 59 years of age, and probably considerably older, when he went on that fatal expedition against the Indians.

§ 201. John Sherman bore the title of Sergeant until after the decease of Ensign Thomas Bartlett, in 1654, and after that, bore the title of Ensign until after the decease of Capt. Beers, when he attained the rank of Lieutenant, and he held this rank until after the decease of Captain Mason. In the town records, he does not bear the title of Captain, until 1680, when he was about 67 years old. He seems to

have retained the office until his decease, in 1691, then aged 76, as no one else held that title until after that event. He was succeeded in office by William Bond, Esq., who had then been a magistrate about five years. He had borne the title of Corporal until he was elected magistrate in 1686, when he was about 61 years old. In 1676, the Court appointed him lieutenant of a company of horse, but, as he continued to be honored with the title of corporal for ten years afterwards, probably he did not accept the appointment. He had the title of Lieutenant in 1689, and when he attained the rank of Captain, he was about 67 years old. Thomas Strait bore the title of Captain at an earlier date, but he probably brought the title with him, and never held the office in Watertown.

§ 202. From the preceding statement, it seems to have been strictly true that, of military officers, "few died and none resigned," except with life. A considerable change, however, took place soon after the decease of Capt. Sherman, and military titles became more numerous. This appears to have resulted from two causes. In the first place, rotation of office was more frequent. In the second place, there were more offices to be filled, there being three military companies in the town. About 1691 or '92, the town was divided into three military precincts. The first was the precinct of Capt. Bond's Company. The second was the precinct of Lieut. Garfield's Company—of those belonging to what was sometimes called the middle precinct, now Waltham. The third was the precinct of Lieut. [Josiah] Jones's Company, of those who belonged to the Farmers' precinct, now Weston. John Warren bore the title of Captain about 1691, but of what company the records do not show. The military titles pertaining to various persons will generally be found in the genealogies, where they belong. So far as appears in the records, Jonas Bond, Esq., was the first Watertown man who attained the rank of Major and of Colonel.

§ 203. On the files of the Middlesex Court, is the following certificate or memorial of soldiers, dated Ap. 15, 1690. Most of them belonged to Watertown. "Being listed in the service of the country against the French, and ordered down to Charlestown, and being denied quarters elsewhere, the widow Mary Peachee did entertain us." [Signed] "Nathaniel Barsham, Lt.; Wm. Davenport, Sergt.; Samuel Barnard, Corporal; Richard Mellins, John Applin, John Fisk, Peter Mansel, John Smith, John Swetin, Thomas Stratton, Henry Spring, John Fay, Thomas Willson (? Woolson), Nathaniel (?) Wod, Solomon Ray, George Stevens (? Stearns), John Poney [Perry?], Josiah Jones, Joseph Garfield, James Ball." Upon this certificate, there was a motion to the Court to renew her license.

CIVIL AFFAIRS AND OFFICERS.

§ 204. After the departure of Sir Richard Saltonstall to England, in 1631, there was no Assistant or Magistrate, resident of Watertown, for more than fifty years. All suits were brought before the Court of Assistants, until Mar. 1636, when four County Courts were ordered to be held every quarter, to try civil actions, where the "debt or damage did not exceed £10," and "all criminal causes, not concerning life, murder, or banishment." Although only the Assistants bore the title of magistrates, yet others were empowered to perform the judicial functions of magistrates. At County Courts, it was required that not less than one magistrate [Assistant] should be present, and that not less than five persons should be on the bench; and for holding these Courts, the General Court appointed "magistrates and other gentlemen,"—"other persons of worth to be joined as associates to the magistrates." At the General Court in May, next after passing the order for county courts, the persons were appointed for holding them, and Mr. [Robert] Feake, of Watertown, was

appointed for that to be held at New Town, for the towns of Charlestown, Concord, Medford, Watertown, and New Town. The next year Mr. Richard Browne, of Watertown, received the same appointment. These five towns were the nucleus of the County of Middlesex. At the same time that Mr. Feake and Mr. Browne, of Watertown, held appointments as associates in these courts, there were Commissioners for ending small causes in Watertown, showing that they were not regarded as magistrates.

§ 205. On the 6th of Sept., 1638, the General Court, "for avoiding of the country's charge by bringing small causes to the Court of Assistants," ordered, "that any magistrate in the town where he dwells, may hear and determine by his discretion all causes, wherein the debt or trespass, or damage, &c., doth not exceed 20s.; and in such town, where no magistrate dwells, the General Court shall from time to time nominate three men, two whereof shall have like power to hear and determine all such actions under 20 shillings." From their decision there was an appeal to a Quarter Court, a Court of Assistants. These men were entitled Commissioners—"Commissioners for ending small causes." They were invested with some of the functions of justices of the peace, without the title.

§ 206. At that time there were four towns (Watertown, Weymouth, Hingham, and Newbury), in which no Assistant resided, and for each of which, accordingly, Commissioners were appointed. Those for Watertown were "Mr. Thomas Mayhew, Capt. William Jennison, and Mr. Richard Browne." They were reappointed in June, 1639, and again in June, 1641. In May, 1643, "Mr. Simon Eyre, Capt. Jennison, and Hugh Mason; and John Sherman [temporarily] till Capt. Jennison come." In May, 1645, Mr. Richard Browne, Lieut. [Hugh] Mason, and Ephraim Child were appointed; and this appears to be the last time that such Commissioners were appointed by the General Court, who, in May, 1647, ordered them thereafter to be appointed by the County Courts; and in the succeeding November ordered them "to keep a true record of all such causes as shall come before them to be determined." In 1652, they were authorized to administer oaths in civil cases; and in 1656, they were authorized to solemnize marriages. These and other powers were taken from them the next year.

§ 207. Marriage was for a long time regarded as a civil contract, and performed only by magistrates, or by persons commissioned by the General Court for that special service, in towns where no magistrate resided. [See §§ 58 and 59.]

§ 208. The earliest notice in the records of the County Court, of the appointment of Commissioners for Watertown, is in April, 1650, where are found the following appointments. The earlier records of this Court are lost. At a town meeting, Ap. 4, 1659, it was ordered, that the Commissioners to end small causes should meet on the first Monday in May, August, November, and February.

Ap. 2, 1650. Mr. [Richard] Browne, Lieut. [Hugh] Mason, Ephraim Child.

Ap. 1652. Lieut. Mason, John Sherman.

Ap. 1653. Mr. R. Browne, Capt. Mason, John Sherman.

Ap. 1654. Mr. Browne, Capt. Mason, John Sherman.

Ap. 1655. Mr. Browne, Ephraim Child, Michael Barstow.

Ap. 1656. Mr. Browne, Ephraim Child, Michael Barstow.

Ap. 1657. Capt. Mason, Ephraim Child, Michael Barstow.

Ap. 1658. Capt. Mason, Ephraim Child, Michael Barstow.

Ap. 1659. Capt. Mason, Ephraim Child, Michael Barstow.

Ap. 1661. Capt. Mason, Ephraim Child, Michael Barstow.

The 2d volume of the records of the County are lost, and therefore, the names of the Commissioners of that period have not been obtained.

§ 209. The first magistrate or justice of the peace of Watertown, of whom any notice has been found, subsequent to the departure of Sir Richard Saltonstall, was William Bond, who was appointed as early as 1686. He died in Dec. 1695, and was probably succeeded by Ebenezer Prout. The next magistrate was Jonathan Phillips, son of Rev. G. Phillips. He died early in 1704. Jonas Bond, youngest son of

William Bond, Esq., was appointed a justice of the peace and of the County Court prior to Mar., 1708, and before the decease of Mr. Jonathan Phillips. He d. in April, 1727. The next justice was Dea. Joseph Mason, who was appointed previously to May, 1734. He d. in 1755. Nathaniel Harris was appointed before Dec., 1734. He d. in 1761. Jonas Bond, eldest son of Jonas Bond, Esq., was commissioned by Governor Shirley, Jan. 11, 1748, when there were two other justices in town. He d. in 1768. From this period to 1800, there were several justices of the peace, residents of Watertown. We have the names of several, if not all of them, but know not the date or duration of their appointments, viz.: Dr. Josiah Converse, William Hunt, (?) Henry Gardner, (?) Elijah Bond, Jonathan Brown, Josiah Capen, Dr. Marshall Spring, Amos Bond, Nathaniel R. Whitney.

REPRESENTATIVES OF WATERTOWN.

§ 210. According to the Charter of the Massachusetts Bay Company, there were to be "four Great and General Courts of the said Company," held upon "every last Wednesday of Hillary, Easter, Trinity, and Micha[elmas]." The Company, besides the Governor, consisted of the Assistants and the Freemen; that is, besides those named in the Charter, "all such others as shall hereafter be admitted and made free of the Company and Society." These Courts, so constituted (of Governor, Assistants, and Freemen) had full power and authority to choose, nominate, appoint, and admit others "to be free of the said Company;" to elect and constitute officers for ordering, managing, and despatching the affairs of the Corporation; "and to make laws and ordinances for the good and welfare of the said Company." It was also ordered by the Charter that the authority, office, and power, conferred upon any one by election, "shall cease and determine" upon the election of a successor.

§ 211. The principles and provisions of this Charter were more liberal than its administration. Notwithstanding such ample powers, both elective and legislative, were granted to the freemen, who were very numerous compared with the Governor and Assistants, they had, for some time, very little influence in the government. One chief cause of this was probably their great number, occasioning an unwieldiness in making use of their power and privileges. The Governor and Assistants took advantage of this, and, says Hutchinson, "kept the powers of government, both legislative and executive, very much in their hands the first three years. The people began to grow uneasy, and the number of freemen being greatly multiplied, an alteration of the constitution seems to have been agreed upon, or fallen into by the general consent of the towns; for, at a General Court of Elections, in [May], 1634, twenty-four of the principal inhabitants appeared as the representatives of the body of freemen, and, before they proceeded to the election of magistrates, the people asserted their right to a greater share in the government than had hitherto been allowed them, and resolved, That none but the General Court had power to make and establish laws, or to elect and appoint officers, as governor, deputy-governor, assistants, treasurer, secretary, captains, lieutenants, ensigns, or any of the like moment, or to remove such upon misdemeanor, or to set out the duties and powers of these officers: That none but the General Court hath power to raise monies and taxes, and to dispose of lands, viz., to give and confirm properties."

§ 212. It is remarkable that the colonial records contain no reference to the origin or introduction of a House of Deputies into the government. The first notice of them is, that they are there, without asking or being invited. Winthrop, however, throws some light on the subject, but not a full elucidation, and we are left to conjecture. [Winthrop, I. p. 128.] It is probable that the concert of action among the freemen

of the several towns began with the appointment and the meeting of committees of two from each of those towns in 1632, "to advise with the Governor and Assistants about the raising of public stores, so as what they should agree upon should bind all," &c. Mr. Savage asks, "Why the notice mentioned in the text should be given?" It seems probable that this was only the usual notice required by the Charter to be issued by the Governor, summoning a meeting of the General Court. On the first of April, 1634, six weeks before that meeting of the General Court, at which deputies first appear on the record, the freemen, two from each town, deputed to "meet and consider of such matters as they were to take order in" at the ensuing General Court, "having met, desired a sight of the patent." This seems to imply that the Charter had hitherto been kept out of the sight of the freemen, at least so far that they were not fully acquainted with its provisions. Having seen the Charter, and having found that it required all the laws to be enacted by the General Court, they "repaired to the Governor (Winthrop) to advise with him about it." He endeavored to convince them that they had not "a sufficient number of men qualified for such a business" as legislation, and to induce them to take such a course as to leave legislation to the Governor and Assistants. The result was that, soon afterwards, at the ensuing General Court, Mr. Winthrop, for the first time, failed of being elected Governor, and the Court passed an order admitting the claims of the deputies to have "the full power and voices of all the said freemen, * * * for the making and establishing laws, granting lands, &c., and to deal in all other affairs of the commonwealth, wherein the freemen have to do, the matter of election of magistrates and other officers only except, wherein every freeman is to give his own vote."

For a view of the influence or agency which Watertown people had in effecting this change in the government: in checking its aristocratic tendency; in resisting taxation without representation; and establishing a representative republic, see Winthrop, I. pp. 70, 71, 128, 129; also Richard Browne, p. † 123, and § 147-49.

§ 213. By the General Court, Sept. 8, 1636, "it was ordered, that, hereafter, no town in the plantation, that hath not 10 freemen in it, shall send any deputy to the General Court; those that have above 10 and under 20, not above one; betwixt 20 and 40, not above two; and those that have 40, three, if they will, but not above." In Oct., 1636, it was ordered, that each town pay the charges of their own deputies; but this order was reversed the next March, and the order re-established, that their charges be borne by the country. On 13th March, 1638-9, "it was ordered, that no town shall send more than two deputies to the General Court." In the course of the next ten years, the Court made repeated attempts to alter the mode of the election of deputies, or to lessen their number, all tending to diminish the influence of the freemen in the government. These attempts were resisted, and the record of the Court for March, 1647-8, says, "The most of the freemen desiring their former liberty of sending one or two deputies to the General Courts from time to time, the former wonted liberty is continued, and the former act, in suspense, is repealed." This *desire of most of the freemen* was formally expressed by their vote upon a proposition submitted to them by the Court.

§ 214. *Representatives*, with the date of their election.

1634, May, 14. Mr. Robert Feake, Mr. Richard Browne, Mr. John Oldham.	1635-6, Sept. 8. Lt. Robert Feake, Mr. [Edward] Howe, Mr. Thomas Mayhew.
1634-5, Mar. 4. Mr. Robert Feake, Mr. Richard Browne, Ens. William Jennison.	1635-6, Dec. 7. Lt. Robert Feake, Mr. [Edward] Howe (only two).
1634-5, May, 6. Mr. Robert Feake, Mr. Edward Howe, Ephraim Child.	1637, Ap. 18. Mr. Richard Browne, Capt. Wm. Jennison, Mr. Bryan Pendleton.
1634-5, Sept. 2. Mr. Richard Browne, Mr. Edward Howe, Ens. Wm. Jennison.	1637, May 17. Mr. Richard Browne, Capt. Wm. Jennison, Mr. Thomas Mayhew.
1635-6, Mar. 3. Lt. Robert Feake, Mr. Bryan Pendleton, Ens. William Jennison.	1637, Sept. 26. Mr. Richard Browne, Capt. Wm. Jennison, Mr. Thomas Mayhew.
1635-6, May 25. Lt. Robert Feake, William Swain, Ens. William Jennison.	1637, Nov. 2. Mr. Richard Browne, Capt. Wm. Jennison, Mr. Bryan Pendleton.

1637-8, Mar. 6. Mr. Richard Browne, Mr. Bryan Pendleton, Mr. Thomas Mayhew.
 1637-8, May 2. Mr. Richard Browne, Mr. Bryan Pendleton, Mr. Thomas Mayhew.
 1637-8, Sept. 6. Mr. Richard Browne, Capt. Wm. Jennison, Mr. Thomas Mayhew.
 1638-9, Mar. 13. Mr. Richard Browne, Capt. Wm. Jennison, Mr. Thomas Mayhew.
 1638-9, May 22.* Mr. Richard Browne, Mr. Thomas Mayhew.
 Mr. Edward Howe [substitute for R. Browne, absent].
 1639, Sept. 4. Capt. Wm. Jennison, Mr. Thomas Mayhew.
 1640, May 13. Capt. Wm. Jennison, Mr. Thomas Mayhew.
 1640, Oct. 7. Capt. William Jennison, Mr. Thomas Mayhew.
 1641, June 2. Capt. William Jennison, Mr. Thomas Mayhew.
 1641, Oct. 7. Capt. William Jennison, Mr. Simon Eire.
 1642, May. Record wanting.
 1642, Sept. 8. Capt. Wm. Jennison, Elder Edward Howe.
 1643, May 10. Mr. Thomas Mayhew, Elder Edward Howe.
 1643-4, Mar. 7.† Mr. Thomas Mayhew, Hugh Mason.
 1643-4, May 29. Mr. Thomas Mayhew, Hugh Mason.
 1645, May 14. Capt. Wm. Jennison, Lieut. Hugh Mason.
 1646, May 6. Mr. Richard Browne, Ephraim Child.
 1647, May 26. Mr. Richard Browne, Mr. Bryan Pendleton.
 1648, May 10. Mr. Richard Browne, Mr. Bryan Pendleton.
 1649, May 2. Mr. Richard Browne, Ephraim Child.
 1650, May 22. Mr. Richard Browne, Ephraim Child.
 1651, May 7. Mr. Richard Browne, John Sherman.
 1652, May 27. Mr. Richard Browne, Ephraim Child.
 1653, May 18. John Sherman, Michael Bairstow.
 1654, May 3. Mr. Richard Browne, Ephraim Child.
 1655, May 23, Mr. Richard Browne, Ephraim Child.
 1656, May 14. (Only one), † Ephraim Child.
 1657, May 6. Charles Chadwick, Ephraim Child.
 1658, May 19. John Coolidge, John Wincoll.
 1659, May 11. Charles Chadwick, Ephraim Child.
 1660, May 30. Capt. Hugh Mason, Ephraim Child.
 1660, Dec. 19. Capt. Hugh Mason, Ephraim Child.

1661, May 20. Capt. Hugh Mason, Ephraim Child.
 1662, May 7. (Only one), Ephraim Child.
 1663, May 27. John Sherman, Richard Beers.
 1664, May 18. Capt. Hugh Mason, Richard Beers.
 1665, May 3. Samuel Thatcher, Richard Beers.
 1666, May 23. Samuel Thatcher, Richard Beers.
 1667, May 15. (Only one), Richard Beers.
 1668, Ap. 29. Samuel Thatcher, Richard Beers.
 1669, May 19. Samuel Thatcher, Richard Beers.
 1670, May 11. (Only one), Richard Beers.
 1671, May, 31. Capt. Hugh Mason, Richard Beers.
 1672, May 15. (Only one), Richard Beers.
 1673, May 7. Thomas Hastings, Richard Beers.
 1674, May 27. Capt. Hugh Mason, Richard Beers.
 1675, May 12. Capt. Hugh Mason, Richard Beers.
 1676, May 3. Capt. Hugh Mason (only one).
 1677, May 23. Capt. Hugh Mason (only one).
 1678, May 8. Simon Stone (only one).
 1679, May 28. Simon Stone (only one), and in 1680, '81, '82, and May, '83.
 1683, Nov. 7, Simon Stone, Thomas Fox.
 1684, May 7. Simon Stone.
 1685, None recorded.
 1686, May 12, Simon Stone (only one).

Usurpation from May 15, 1686, to Ap. 18, 1689. Revolution.

1689, May 8. William Bond, Esq. (only one).
 1689, May 22. William Bond, Esq., Benjamin Garfield.
 1689, June 5. William Bond, Esq., Simon Stone.

Provisional Government, formed June 6, 1689.

1689, Nov. 5. William Bond, Esq. (only one).
 1689, Dec. 3, William Bond, Esq., Simon Stone.
 1689-90, Feb. 12. William Bond, Esq., Simon Stone.
 1689-90, May 28 and Dec. 10. William Bond, Esq. (only one).
 1691, Dec. 8. WILLIAM BOND, Esq., Speaker (only one).
 1692, May 4. Benjamin Garfield (only one).

* At this date and afterwards only two deputies. [See Section, 213.]

† In Oct., 1643, the Court ordered the proposition to be submitted to the freemen for their approval, that the deputies should hereafter be chosen for a whole year, instead of being elected for each of the four Courts.

‡ About this time, Mr. Richard Browne moved to Charlestown.

*Second Royal Charter, uniting the Colonies of
Plymouth and Massachusetts Bay.*

1692, June 8. WILLIAM BOND, Speaker, Benjamin Garfield.

1693, May 31. WILLIAM BOND, Speaker, Benj. Garfield.

1694, May 30. Ebenezer Prout, Benj. Garfield.

1695, May 29. Wm. BOND, Speaker, d. next Dec.

1696, May 26. None recorded.

1697, May 26. Benjamin Garfield.

1698, May 25. Do. do.

1699, May 31. Do. do.

1700, May 29. John Page.

1701, May 28. Daniel Warren.

1702, May 27. Joseph Sherman.

1703, May 26. Do. do.

1704, May 31. Do. do.

1705, May 30. Do. do.

1706, May 29. Jonas Bond, Esq.

1707, May 28. Do. do.

1708, May 26. Samuel Bigelow.

1709, May 25. Do. do.

1710, May 31. Do. do.

1711, May 30. John Sanderson.

1712, May 29. Do. do.

[After this date Weston had a separate representation.]

1713, May 27. Caleb Church.

1714, May 26. Samuel Stearns.

1715, May 25. Do. do.

1716, May 30. Thomas Straight.

1717, May 29. Benjamin Garfield.

1718, '19 and '20, May. Samuel Stearns.

1720, July 15. Jonas Bond, Esq.

1721, May 31. Samuel Stearns.

1722, May 30. Lieut. Richard Coolidge.

1723, May 29. Jonas Bond, Esq.

1724, '25 and '26. Jonas Bond, Esq.

1727, '28 and '29. Nathan Fiske.

1730 and '31, May. Samuel Stearns.

1732, May 31. Nathan Fiske.

1733 and '34, May. Joseph Mason, Esq.

1735, '36 and '37, May. Nathaniel Harris, Esq.

[After this date Waltham had a separate representation.]

1738 to 1744. Jonas Bond.

1745, May 29. John Hunt.
1746 to 1750. Jonas Bond, Esq.

1751 to 1757. John Hunt.

1758. (None recorded.)

1759 to 1767. John Hunt.

1768 to 1771. John Remington.

1772 to 1774. Capt. Jonathan Brown.

(Provincial Congress.)

1774, Oct. 7. Jonathan Brown, John Remington, Samuel Fisk.

1775, Feb. 1 and May 31. Jonathan Brown.

1776, May 29. Jona. Brown, Samuel Fisk.

[At a Convention in Concord, July 29, 1779, to sanction measures of Congress, Richard Clark and Jedediah Leathe were delegates from Watertown.]

1777, '78, '79, '80, '81. Jonathan Brown.

1782, May. (None recorded.)

1783, May 28. Jonathan Brown.

1784, May 26. William Hunt, Esq.

1785 and '86, May. Jonathan Brown.

1787, May 30. Dr. Marshall Spring.

1788 to 1793. Col. Amos Bond.

1794, May 28. William Hunt, Esq.

1795 to '99. Col. Amos Bond.

1800 and 1801. William Hunt, Esq.

1802, May 26. Col. Amos Bond.

1803 to 1807. Jonas White.

1808, May 25. Thomas Clark.

1809 to 1815. Thomas Clark and Jonas White.

1817. (None recorded.)

1818 to 1821. Levi Thaxter, Esq.

1822. (None recorded.)

1823. Abijah White.

1824. Abijah White and Thomas Clark.

1825. (None recorded.)

1826, May. Seth Bemis, Esq.

1827, May 30. Nathaniel Bright.

1828, May 28. John Clark.

1829, May 27. John Clark, Charles Bemis, Esq.

1830. John Clark, Charles Bemis, Esq.

1831. Isaac Thaxter, Charles Bemis, Esq.

1832. Levi Thaxter, do. do.

1833. William Stone, do. do.

1834. Do. do. do. do.

1835 and '36. Isaac Robbins.

1837. George Robbins, William Stone.

1838. Do. do.

§ 215. *Selectmen of Watertown.* [See Sections † 46-48.]

By recurring to the original records (pp. 995, &c.), it will be seen that the selectmen were not at first designated by that title. They were those "chosen by the freemen to order the civil affairs of the town." The first time that title was applied to them was in 1647, at the commencement of the records, after that hiatus in them, 1643 to 1647. The first board (1634) consisted of three members. The next four (1635, '36, '37, '38) consisted of eleven members; the next three (1639, '40, '41) of twelve members; the next two (1642, '43) of nine members. These were chosen by the freemen, and a recurrence to p. 1017 will show that the number of selectmen was large in proportion to the number of freemen. The number elected in 1647, when they are first entitled *selectmen* in the town records, was seven, and this

continued to be the regular number for a long time, at least for many years after the incorporation of Weston. T. C. for Town Clerk: Tr. Treasurer.

- William Jennison, 1684, '85, '86, '87, '89, '40, '41, '42, '48.
 Bryan Pendleton, 1684, '85, '86.
 John Eddie, 1684, '85, '86, '87, '71. [Perhaps this last was John, Jr.]
 Richard Browne, 1685, '88, '89, '41, '42.
 Abraham Browne, 1685, '86, '87, '88, '39, '40, '41.
 Edmund Sherman, 1685.
 Ephraim Child, 1685, '87, '40, '41, '42, '50, '51, and T. C., '53, '56, '57, '58, '59, '60, and T. C., '61, and T. C., '82, and T. C.
 John Loveran, 1685, '86.
 John Warren, 1685, '89.
 John Batchelor, 1685.
 Charles Chadwick, 1685, '40, '41, '51, '54, '58, '59, '60, '72.
 Thomas Mayhew, 1686, '37, '38, '39, '40, '42.
 Robert Feake, 1686, '38, '39.
 Edward Howe, 1686, '38, '40, '41, '42.
 Simon Eire, 1686, '37, '38, '39, '40, '41, '43. T. C. and Clerk of Writs several years.
 John Sherman, 1686, '41, '42, '48, '48, '49, '50, '52, '58, '54, '57, '58, '64, T. C., '65, T. C., '66, T. C., '67, '68, '69, '76, '77, '80, '82, declined. Clerk of Writs, 1645.
 Simon Stone, 1686, '40, '41, '50, '51, '55, '56.
 Daniel Patrick, 1637.
 John Whitney, 1637, '48, '51, '55, and T. C.
 Edmund James, 1637.
 John Firman, 1637.
 John Stowers, 1637.
 Edmund Lewis, 1637.
 Edward Garfield, 1637, '55, '62.
 John Coolidge, 1638, '39, '40, '41, '42, '64, '65, '66, '68, '69, '77, '80, '82.
 Thomas Bartlett, 1638, '48, '52, '54.
 Hugh Mason, 1638, '40, '41, '42, '43, '49, '50, '52, '53, '54, '56, '57, '58, '59, '60, '61, '62, '63, '65, '66, '67, '68, '69, '72, '75, '76, '77, '78.
 Thomas Hastings, 1638, '39, '40, '41, '42, '50, '51, '54, '58, '59, '61, '62, '63, '67, '70 and T. C., '71 and T. C., '77, '80.
 Nicholas Busby, 1639, '48.
 David Fiske, 1639, '42.
 Henry Bright, 1639, '40, '52, '54, '60, '61, '64, '67, '80.
 Michael Bairstow, 1643, '49, '52, '53, '57, '58, '59, '60, '61, '62, '64, '65, '67.
 Richard Beers, 1643, '52, '53, '54, '56, '57, '58, '60, '61, '62, '63, '71, '73, '74, '75, declined.
 John Bernard, 1643.
 Mr. [Nathaniel] Bisco, 1648, '50.
 Joseph Bemis, 1648, '72, '75.
 William Hammond, 1648.
 Roger Porter, 1648.
 Mr. [Jeremiah] Norcross, 1649.
 Edward Dix, 1650.
 John Wincoll, 1649, '56, '62.
 John Flemming, 1649.
 Samuel Thatcher, 1651, '55, '56, '59, '70.
 Isaac Mixer, 1651, '55.
 John Bisco, 1652, '64, '68, '79, '80, '82, declined.
 William Barsham, 1653.
 Nathaniel Treadway, 1653, '55, '63, '64, '65, '66, '69, '70, '72.
 Thomas Underwood, 1666.
 William Bond, 1657, '63, '66, '67, '69, '71, '75, '77, '80 and T. C., '82.
 Joseph Tainter, 1657, '64, '65, '66, '67, '72, '80.
 Isaac Stearns, 1659, '70, '71.
 John Hammond, 1664, '70.
 John Sawin, 1664, '72.
 John Bigelow, 1665, '70, '71.
 John Livermore, 1666, '68, '69.
 Ellis Barron, 1668, '78.
 Mr. [William] Goddard, 1668, '69. Clerk of Writs, 1691.
 Thomas Flagg, 1671, '74, '75, '76, '78, '81, '85, '86, '87.
 Simon Stone, Jr. [6], '72, and T. C., '73 and T. C., '74, '75, '76 and T. C., '77 and T. C., '78, '79 and T. C., '81 and T. C., '82 and T. C., '83, '84 and T. C., '85, '86, '87 and T. C., '90 and T. C.
 Nathan Fiske, 1678.
 Isaac Mixer, Jr., '73, '85, '87, '88, '89, '91, '92, T. C., '93-4, '95, '96, '97, '99, 1701.
 John Whitney, Jr., '73, '74, '75, '76, '78, '79.
 Samuel Stearns, 1673, '74, '75, '76, '78, '79, '81, '82.
 George Woodward, 1674.
 John Stone, 1674, '81, '82, '83, '84, '85, '86, '87, '90.
 John Warren, Jr., 1676, '91.
 Nathaniel Coolidge, 1677, '92.
 Gregory Cook, 1678, '79, '81.
 Roger Wellington, 1678, '79, '81, '82, '83, '84, '91.
 Robert Harrington, 1679, '81, '82, '83, '85, '91, '92, '93-4, '95, '96, '97, '98, '99, 1700.
 John Stratton, 1682, '83.
 Daniel Warren, 1682, '83, '85, '88, '89, '92, '93-4, '95, '96, '97, '98.
 Thomas Fanning, 1683.
 John Coolidge, Jr., 1684, '86, '87, '88, '89, '90.
 Samuel Livermore, 1684, '90.
 John Bright, 1684, '90.
 Nathan Fiske, Jr., 1684, '88, '91.
 Josiah Jones, 1685, '86, '87, '90, 1702, '9. After 1712, of Weston.
 Jonathan Browne, 1686.
 Nathaniel Barsham, 1686, '93, T. C.
 Benjamin Garfield, 1687, '88, T. C., '89, T. C., '90, '91, '92, '95, T. C., '96, T. C., '97, T. C., '98, T. C., '99, T. C., 1700, T. C., 1701, T. C., '2, T. C., '8, T. C., '5, '6, T. C., '9, '10, '17.
 Richard Child, 1688, '89.

- Richard Sawtel ("Sattle"), 1698.
 Philip Shattuck, 1689, 1700, '11, '13.
 Samuel Jennison, 1691, and T. C.
 Munning Sawin, 1691, '94, Tr., 1708, '4, T. C., '5, '6, '7. Clerk of Writs, 1691.
 John Hammond, 1692, '98, 1701.
 Caleb Church, 1692, '98, '99, 1700, '1, '2, '18.
 John Livermore, Jr., 1692.
 Richard Cutting, 1698.
 Ebenezer Prout, 1693-4, T. C., '95.
 John Morse, 1694, '96, '97, '98.
 John Parkhurst, 1694, '95.
 Thomas Hammond, 1694, '96.
 John Page, 1695, '96, '97, '98.
 Nathaniel Bond, 1686.
 Samuel Bigelow, 1697, 1708, '9, '10, '18, '14, '16,
 Uriah Clark, 1699, 1700.
 Thomas Woolson, Sen., 1699, 1702, '8. After 1712, of Weston.
 Joseph Sherman, 1701, '2, '3, '4, '5, '9, '10, '11, '12.
 Daniel Harrington, 1701, '2, '4, '5, '6, '9, '10, '11, '12, '13, '18, '29.
 Jonas Bond, 1701, '2, '3, '4, '5, '6, '7, '9, '10, '17, '18, '19, '20, '22, '23, '24, '25, '26, '27.
 Jonathan Smith, 1708, '4, '5, '6, '7, '12, '18, '14, '15, '16.
 Jonathan Sanderson, 1708, '4, '5, '6, '14, '16, '17, '18, '19.
 Thomas Straight, 1704, 1708, Tr., '12, '16, '80.
 Abraham Gale, Sen., 1706, '18.
 Nathaniel Bright, 1707, '17, '28, '81.
 John Bemis, 1707.
 Palgrave Wellington, 1707.
 Joseph Peirce, 1708, '22, '86, '87. After this, of Waltham.
 Samuel Stearns, Jr., 1708, T. C., '9, T. C., '10, T. C. and Tr., '11, T. C. and Tr., '12, Tr., '13, T. C. and Tr., '14, '15, T. C. and Tr., '16, T. C. and Tr., '17, Tr., '18, '19, '26, '27, '29, '30, '81.
 Joseph Brown, 1708. After this, of Lex.
 Francis Fulham, 1710, '11. After 1712, of Weston.
 Richard Coolidge, 1711, '15, '18, '19, '20, '22, '23, '24, '26, '27, '28.
 Nathaniel Stearns, 1716.
 Edward Harrington, 1716, '30, '81.
 William Fiske, 1717.
 Thomas Livermore, 1719, '20, '22, '28, '24, '25, '26, '28, '32, '33. After 1787, of Waltham.
 John Cutting, 1719, '20, '23. After 1787, of Waltham.
 Jonathan Sanderson, Jr., 1720, '24.
 John Coolidge, 1720, '25, T. C., '88, '41.
 Samuel Garfield, 1722, '29.
 Jonathan Stone, 1724, '27.
 William Brown, 1725, '28, '88, '84, '86, '87. After 1787, of Waltham.
 Thomas Leonard, 1725, '29.
 Thomas Coolidge, 1726, '83, '84, '85.
 Thomas Bigelow, 1728, '88, '84, '86, '87. After this, of Waltham.
 John Smith, 1727, 85.
 Nathan Fiske, 1728, '82, '89.
 Joseph Mason, '29, '32, '34, '89, '40, '41, '42, '43, '44, '45, '46, '47, '49, '50, '52, '53.
 Henry Bright, 1729.
 Joseph Coolidge, 1729, '32, '39, '42.
 Samuel Peirce, 1731, '32, '34, '35, '86, '37.
 George Livermore, 1730 [? Thomas].
 Jonas Bond, Jr., 1730, '31, '32, '38, '39, '40, '41, '42, '43, '44, '45, '46, '47, '48, '49, '50, '52, '53, '56, '59, '60, '61, '62.
 Thomas Hammond, 1730, '31, '32.
 John Fiske, 1731.
 Anthony Caverly, 1733, '34.
 Nathaniel Harris, '33, '84, '85, '86, '87, '88, '89, '42, '44, '45, '47.
 Daniel Benjamin, 1735, '86, '87. After this, of Waltham.
 John Bemis, Jr., 1735.
 Thomas Harrington, 1735.
 John Sawin, 1736, '87.
 Oliver Livermore, 1738, '41, '43, '46, '48, '49.
 Jonathan Brown, 1739, '40, '41.
 John Tainter, 1740, '41.
 Ebenezer Stone, 1741, '46.
 Jonathan Bemis, 1743, '44, '45, '48, '49, '50, '52, '53, '54, '57, '58.
 Daniel Whitney, 1751, '55, '57, '59, '60, '61, '62, '81, '82.
 Joseph Harrington, 1743, '50, T. C.
 John Bright, 1746.
 John Hunt, 1747, '52, '54, '55.
 Ebenezer Thatcher, 1747, '49.
 Josiah Convers, 1748, '56, '57, '58.
 Isaac Sanderson, 1749.
 Edward Harrington, 1750, '53, '54, '56, '61, '62.
 Andrew White, 1751, '62.
 Samuel Fiske, 1751, '53, '54, '55, '56, '57, '58, '71, '72.
 Nathaniel Coolidge, 1751, '55, '58, '59, '60.
 John Whitney, 1751.
 Josiah Stearns, 1754, '55.
 Ebenezer Stone, 1756.
 Samuel Hagar, 1757.
 Amos Bond, 1758, '59, '60.
 Jonathan Child, 1759, '60, '61, '62, '63, '64, '65.
 Nathaniel Stone, 1761, '63, '64, '65, '71, '80.
 Nathaniel Harrington, 1763, '64.
 John Kimball, 1765, '66, '67, '68, '69.
 Moses Stone, 1768, '64, '65, '66, '67, '68, '69, '70.
 Jonathan Bemis, Jr., 1766, '67, '68, '69, '70.
 Jonas White, 1766, '67, '68, '69, '70.
 Jonathan Browne, 1765, '66, '67, '68, '69, '70, '76, '77, '78, '79, '80.
 Nehemiah Mason, 1770, '71, '72, '78.
 John Remington, 1771, '72, '77.
 Thomas Clark, 1771, '72.
 Samuel White, 1778, '74, '75, '76, '79, '86.
 David Bemis, 1778, '74, '75, '76, '79.
 Josiah Capen, 1778, '74, '75, '76, '83, '85.

- | | |
|--|---|
| David Sanger, 1778, '74, '75, '76, '79, '85, '87, '88, '89, '90, '91. | William Hunt, 1788, '89, '90, '97, '99, 1801, '2, '3. |
| Elijah Bond, 1774, '76, '77. | John Fowle, 1790, '92. |
| Samuel Loden, 1778, '79. | Samuel Wellington, 1792. |
| Nathan Coolidge, 1777, '78. | Moses Coolidge, 1793, '94, '95, '96, '98, '99, 1800, '1, '2, '3. |
| Jedediah Lethe, 1777, '78, '80. | Daniel Jackson, 1793, '94, '95. |
| Samuel Barnard, 1779. | James Robbins, 1794, '95, '97. |
| Richard Clarke, 1778, '81, '86, '87. | Edmund Fowle, 1795, 1805, '6. |
| Amos Livermore, 1779, '81, '83, '84, '85, '87, '88, '89, '91, '92, '93, '94. | Nathaniel Bemis, 1796, '98. |
| Daniel Parker, 1781, '82. | Joseph Bright, 1796, '98, 1807, '8, '9. |
| Christopher Grant, 1783, '84, '85, '86, '88, '89, '90, '91, '92, '93, '94. | Jonathan Stone, 1796. |
| Josiah Bisco, 1782, '87. | Moses White, 1797. |
| Amos Bond, Jr., 1782, '84, '88, '90, '91, '92, '93, '94, '95, '96, '98, '99, 1801, '2, '3, '7, '8, '9. | Nathaniel R. Whitney, 1797, '98, '99, 1800, '1, '2, '8, '4, '5, '6, '7, '8, '9. T. C. many years. |
| Nathaniel Bright, 1782, '84. | Francis Faulkner, 1797, '99, 1800. |
| Phineas Stearns, 1783, '84, '85. | Thomas Clark, 1800, '4, '5, '6, '7, '8, '9. |
| Moses Stone, Jr., 1783. | Luke Bemis, 1801, '2, '3, '4. |
| Samuel Loden, 1786. | Charles Bond, 1804, '5, '6. |
| Thomas Pattin, 1786, '87, '89, '90, '91. | Josiah Leonard, 1805, '6. |
| | Amos Livermore, Jr., 1806. |
| | Jonas White, 1807. |
| | Edward Lowd, 1808, '9. |

§ † 215. *Constables.*

Constables were at first elected by the General Court; afterwards by the Quarter Courts, and as early as 1653, and probably earlier, they began to be elected by the towns. The following were some of the early appointments by the Courts:

Oct. 19, 1630, John Page was chosen Constable of Watertown for one whole year, and after till a new [one] be chosen.

May 9, 1632, Mr. [William] Clarke was chosen Constable of Watertown. [See Winthrop, I. p. 74.]

Aug. 5, 1634, Samuel Hosier was chosen Constable. He was constable again in 1650.

1642, Gregory Taylor, Constable, by the Court.

June 4, 1641, John Whitney was chosen Constable by the Quarter Court.

§ 216. *Representatives of Weston*, elected in May.

The first volume of the records of the transactions are lost, and the earlier part of this information has been obtained from the records of the General Court.

- | | |
|--|--|
| Francis Fulham, 1713, '14, '15, '17, '18, Esq., '19, '20, '22, '24, '29, '30, '31, '36, '37. | Abijah Upham, 1750, '51. |
| Josiah Jones, 1716, '21, '25, '26. | Elisha Jones, 1752, '53, '54, '56, '57, '58, '60, '61, '62, '63, '73, '74. |
| Joseph Allen, 1727, '28. | Abraham Bigelow, 1755, '59, '64, '65, '66, '67, '68, '69, '70, '71, '72. |
| Ebenezer Allen, 1732, '33, '34, '35. | Bradyl Smith, 1774, '75, '76. |
| Joseph Livermore, 1738, '39, '40, '42, '43, '48, '49. | Isaac Hobbs, 1777. |
| Josiah Brewer, 1741, '44, '45, '46, '47. | Joseph Roberts, 1778. |

Sept. 29, 1774, Col. Elisha Jones, Esq., a tory, was superseded by the election of Capt. Bradyl Smith, who, the next year, had the title of Colonel. At the same time, Josiah Smith and Samuel Phillips Savage were appointed a committee to attend the Provincial Congress, to be held on the 2d of October, and Capt. B. Smith was added to it. At the same meeting (Sept. 29th), Benjamin Peirce, Dea. Thomas Upham, and Samuel Baldwin, were appointed a committee of correspondence. Jan. 2, 1775, John Allen, Israel Whittemore, and William Whitney, were appointed a committee of inspection, to see that the advice of Congress, relative to the non-importation agreement, be strictly adhered to. The records show that Weston contributed liberally of men and money towards the establishment of liberty and independence. It is left to the historian of Weston to present to the public a full account of her patriotic services and sacrifices.

§ 217. *Representatives of Waltham.*

N.B. The number in brackets refers to his number in the genealogy of the family to which each one belongs.

- Daniel Benjamin [44.], May, 1738, declined to serve.
 Lieut. Thomas Bigelow [98.], 1738, '41.
 Lieut. John Cutting [37.], 1739, '40, '42, '43, '44.
 Capt. Samuel Livermore, Esq. [156.], 1745, '46, '47, '49, '50, '51, '52, '53, '54, '55, '56, '57, '58, '59, '60, '61, '62, '63.
 Capt. John Brown [77.], 1748.
 Capt. Jonas Dix, Esq. [52.], 1764, '65, '66, '67, '68, '69, '70, '72, '73, '74, '75, '76, '77, '80, '81.
 Abner Sanderson, Esq. [46.], 1778, '79, '88, '84, '87, '88, '89, '90, '91, '92, '93, '94, '95, '96, '97, '98, '99, 1800, '1, '5, '6, '7, '8.
 Dr. Leonard Williams, Esq. [17.], 1785, '86.
 Gen. Jonathan Coolidge, Esq. [386.], 1802, '4.
 Col. David Townsend [14.], 1809, '10, '11, '12, '13, '14, '15, '16, '17, '20.

§ 218. *Selectmen of Waltham.*

- Dea. Thomas Livermore [61.], 1738, '39, '40, '41, '42.
 Dea. William Brown, 1738, '39, '40, '41.
 Daniel Benjamin [44.], 1738, '39, '40, '42.
 Joseph Peirce [28.], 1738, '39, '42.
 Lieut. Thomas Bigelow [78.], 1738, '40, '41.
 Capt. John Cutting [37.], 1739, '40, '41, '42.
 Dea. Thomas Hammond [30.], 1741, '43.
 Samuel Hastings [36.], 1742, '43, '44.
 Capt. Samuel Livermore, Esq. [156.], 1743, '44, '45, '46, '47, '48, '49, '50, '51, '52, '53, '54, '55, '56, '57, '58, '59, '60, '61, '62, '63, '64.
 Joseph Garfield [31.], 1743, '45.
 Jonas Smith [35.], 1743, '46, '47, '48, '49, '50, '51, '52, '53, '55.
 Capt. John Brown [77.], 1744, '45, '46, '47, '48, '52.
 Isaac Peirce [117.], 1744, '45, '53.
 John Ball [37.], 1744, '51, '52, '53, '54, '55, '56.
 Hopestill Mead [13.], 1745, '46.
 Samuel Parkhurst [29.], 1746, '47.
 Joseph Hagar, [100.], 1747, '48, '51, '54.
 Joseph Hastings [45.], 1748.
 John Dix [29.], 1749, '50, '52, '53, '58, '59.
 Josiah Fiske [N. Fiske, 52.], 1749, '50.
 Dea. Jonathan Sanderson [39.], 1749, '50, '51, '54, '55, '56, '57.
 Dea. Isaac Stearns [I. Stearns, IV. 111.], 1754, '55, '56, '57, '58, '59, '60, '62, '63, '64, '65, '66, '72.
 Isaac Smith [21-1.], 1756.
 Jacob Bigelow [148.], 1757, '58, '59, '60, '61, '62, '67.
 Lieut. Daniel Child [45.], 1757, '58, '74, '75.
 Capt. Jonas Dix, Esq. [56.], 1759, '60, '61, '62, '63, '64, '65, '66, '67, '68, '69, '70, '71, '72, '73, '74, '75, '76, '77, '78, '80.
 Nathaniel Livermore [109.], 1760, '61, '62, '68.
 Ebenezer Brown [98.], 1761.
 Samuel Harrington [185.], 1763, '64, '65, '71, '72, '73, '74.
 Capt. William Coolidge [168.], 1764, '65, '66, '67, '68.
 Jonathan Hammond [42.], 1765, '66, '68, '69, '70, '71, '72, '74.
 Lieut. Elisha Livermore [120.], 1766, '67, '69, '70, '72, '73.
 Cornet Nathaniel Bridge [47.], 1767, '68, '69, '70, '71, '73, '75, '76, '77.
 Josiah Mixer [77.], 1768, '69, 70.
 Col. Abijah Brown [134.], 1771, '73.
 Josiah Brown [276.], 1774, '75.
 Capt. John Clarke [42.], 1775, '76, '77, '80.
 Josiah Hastings [59.], 1776, '77.
 Capt. Abraham Peirce [161.], 1776, '77, '81, '82, '83, '84, '85, '86, '87, '88, '89, '90, '91, '92, '93, '94, '95, '96.
 Dr. Leonard Williams, Esq. [17.], 1778, '81, '82, '83, '84, '85, '86, '88, '89, '90.
 Abner Sanderson, Esq. [46.], 1778, '79, '80, '87, '88, '89, '90, '92, '93, '94, '95, '96, '97, '98, '99, 1800, '1, '2, '5, '6.
 Elisha Cutler [68.], 1778, '79.
 John Hagar [116.], 1778, '79.
 Capt. Isaac Gleason [4.], 1778, '80, '81.
 Lieut. Amos Brown [229.], 1779.
 Dea. John Sanderson [79.], 1779, '83, '84, '85, '86, '87, '88, '89, '90, '91, '92, '93, '94, '95, '96, 1804, '8.
 Jonas Dix, Jr., Esq. [53.], 1780, '82, '83, '84, '85, '86.
 William Wellington [137.], 1780, '87, '88, '89, '90, '92, '93, '94, '95, '96, '97, '98, '99, 1800, '1, '2, '8.
 Isaac Peirce [137.], 1781, '82.
 Phinehas Lawrence [50.], 1781, '82, '83, '84, '85, '86.
 Benjamin Flagg [? Bezabel, 84.], 1781.
 Abijah Child [51.], 1787.
 Abraham Bemis Jr. [95.], 1791, '92.
 Gen. Jonathan Coolidge, Esq. [386.], 1791, '93, '94, '97, '99, 1800, '1, '2, '3, '4, '7.
 John Bright, Esq. [129.], 1795, '96, '97, '98, 1804, '5, '6, '8, '9, '10.
 Isaac Bemis [133.], 1797, 1803, '7, '11.
 Nathan Smith [154.], 1798, '99, 1801.
 Capt. John Clarke, Jr. [44.], 1798, '99, 1800, '1, '4, '5, '6, '7, '11, '12, '16, '17, '19.
 Nathan Child, 1800.
 Col. David Townsend, Jr., Esq., 1802, '3, '7, '8, '9, '10, '11, '12, '13, '14, 18.

Jonas Brown, Jr. [227.], 1802, '8, '7, '8, '11, '19.	Joshua Barnes, 1810.
David Stearns [C. Stearns, 120.], 1804.	Nathaniel Brown [233.], 1812, '18.
Dr. Uriah Hagar, Esq. [115.], 1805, '6, '8, '9, '14, '15.	John Viles, Jr. [10-1.], 1812, '18, '14, '15, '16, '18, '20.
Joshua Stearns [J. Stearns, 226, V.], 1805, '6.	Elijah Smith [166.], 1818, '14.
Capt. Isaac Miles [q. v.], 1808, '9, '10, '11.	Thomas Stearns, 1818, '14, '15, '18, '19.
Josiah Child [65.], 1809.	Thomas Miller [q. v.], 1816, '17.
Ephraim Peirce [128.], 1810.	Jonas Viles [8.], 1817.
	Jonas Clark, Esq. [47.], 1819, '20.

SCHOOL-HOUSES, SCHOOLS, AND SCHOOLMASTERS.

§ 219. The earliest mention of a school-house in the town records is Sept. 17, 1649, when a rate was ordered for building one, and, on the 2d of November, John Sherman was appointed to build it, 22 feet long, 14 feet wide, and 9 feet between the joists. Dec. 10, 1650, it was ordered to add a turret to the school-house. Jan. 12, 1651-2, an order was passed to pay John Sherman for "work about the turret," and to finish the school-house. It is supposed to have been built on Strawberry Hill, which afterwards bore the name of School-house Hill, and was near John Sherman's residence. In 1676, there was a charge for repairing it. We find no other mention of the school-house in the records until 1696, when one condition of Mr. [Edward] Goddard's consenting to keep school was, that the school-house should be repaired; and a committee was appointed to make an estimate, and to report thereon. Feb. 7, 1708-9, voted, to fix [up] the old school-house, if it can be done for 10 or 12s. Sept. 24, 1711, voted to repair the old school-house, or a part of it, for a watch-house, according to the Governor's direction. A document, on the files of Mid. Court, dated Dec. 19, 1664, states that Watertown School-house was robbed of seventeen Greek and Latin books, by two Indians, one of whom was a servant of Mr. Bisco.

§ 220. At a town meeting, Jan. 31, 1708-9, a committee (B. Garfield and C. Church) reported that they had received [selected] a place, near Phillips's Fence, upon the town's land, leading to Whitney's Hill, near the Middle [Mr. Angier's] Meeting-house, and as near the Causeway, as may be convenient for a school-house. At the same time, it was voted to build a school-house, within twenty rods of the meeting-house, 25 feet by 20, and 6½ feet between joyns. Oct. 8, 1711, the selectmen ordered the "studdey" in the school-house to be completely finished at the town's cost.

§ 221. The first notice of a schoolmaster in the records is Nov. 7, 1649, when the selectmen ordered that **David Mechell* [Mitchell], of Stamford, Conn., be certified of the town's desire for him to keep school. Whether he accepted does not appear from the records. It is not to be certainly inferred from this that there were no schools before this time. There are no town records extant of the first four years (1630-34), and those for the next nine years (1634-43) are little more than general ordinances. The records for the next four years (1643-47) are wanting. A school might have been kept in private houses and in the meeting-house, as was often done afterwards. Jan. 6, 1650-1, *Richard Norcross* was hired for one year for £30, and was allowed 2s. a head for keeping the dryherd. He is the only schoolmaster men-

* He was a brother of Rev. Jonathan Mitchell, who was ordained in Cambridge a few months after the above date, and of Sarah, wife of Samuel Sherman, Esq. [See p. 934.] They were children of Matthew Mitchell, who embarked at Bristol in May, and arrived at Boston, Aug. 17, 1635. He went to Concord with the first settlers, and the next year (1636) moved to Saybrook, where one of his sons was captured and burnt by the Pequots. Soon after this he settled in Wethersfield, where he received, in 1640, the largest grant in the Naubuc Farms of any except that of Clement Chaplin. He was one of the original purchasers of Stamford (Rippowams), and moved there about 1641. (For the numerous descendants of David Mitchell, see Cothren, pp. 633, 34, &c. Also, for the numerous descendants of Sarah [Mitchell] Sherman, see, in the same work, pp. 682, &c.)

tioned until 1675. His salary had continued the same. In 1667, it is stated that the school was to be free to the inhabitants; others (not inhabitants) to pay as before, and their pay to go towards his salary of £30.

237 § 222. Feb. 23, 1674-5, a committee (Capt. Mason and Simon Stone) was appointed to treat with Mr. [William] Goddard to keep school, and he was employed at a salary of £30, to begin Ap. 5, 1675. [See Certificate, p. 237.] Mar. 27, 1677, agreed with Left. Sherman to keep school, to begin Ap. 9th. From May 1 to Aug. 31, to keep eight hours in the day; to begin at seven in the morning and not to break up until five at night, noontime excepted. From Aug. 30 to Oct. 31st, six hours in the day. In March and April, and the four winter months, to begin at ten and continue until two.

§ 223. Jan. 7, 1678-9, the selectmen notified Left. Sherman and Mr. Goddard, giving them one-fourth year notice, that they had chosen another man to keep school, when their year was out, viz., Richard Norcross, from Ap. 9, 1679. In June, July, and August, he was to teach only Latin and writing at his own house; the other eight months Latin and English scholars at the school-house; to have £20 out of the town rates for 1679 (and probably what he could obtain from tuition as before). It was soon after determined to have the school kept the whole year at the school-house, and to add £5 to his salary. Ap. 8, 1679, Lieut. Sherman refused to give up the key of the school-house to those sent to demand it. Dec. 1, 1679, voted that Mr. Goddard shall have £5 for schooling from April last to April next. Dec. 30, 1679, the town voted that Lieut. Sherman is to keep school as formerly. It appears that Lieut. Sherman's was not a grammar school, and the County Court, Dec., 1680, ordered Watertown to provide a grammar school. A committee was appointed, Ap. 1681, to provide a master to teach Latin and English, and Richard Norcross was chosen, Aug. 3, 1681, to begin when "the Captain's" [Sherman] time is out next April. Salary £25, and the benefit of Latin scholars over and above. Mr. Norcross was again employed in 1682 and 1683. He was to be paid for scholars not of the town, and if the [number] be large, the town to have places provided for the boys in the meeting-house.

§ 224. In 1683, it was agreed that those who dwell on the west side of *Stony Brook* (Weston) be freed from school tax of 1683, that they may be the better able to teach among themselves. Mr. Norcross was employed in 1685 and 1686. Those that send children to school to pay 3d. a week for each, and all short of £20 the town to make up to Mr. Norcross. But the town will pay for such children as their parents are unable to pay for, the selectmen being judges. Nov. 26, 1690, the town allowed £15 for the schoolmaster's maintenance. About this period repeated complaints were made to the County Court of the deficiency of schools in Watertown.

§ 225. Dec. 12, 1690, Nathaniel Stone [Stone, 19.] was chosen schoolmaster, and the committee reported, Jan. 9, 1690-1, that he had accepted, twenty persons having engaged to pay, or see him paid, 50s. a quarter, in addition to the £15 granted by the town. Nov. 27, 1693, the selectmen made the following agreement with Richard Norcross: to teach school one year from next Dec. 4th; to be paid by the parents, for English, 3d. a week; for writing, 4d. a week; for Latin, 6d. a week; school to be kept at his house until Ap. 1st; then, upon a month's trial at the school-house, [if] there appear [not] a considerable quantity of scholars, then he hath liberty to keep all the year at his house, and the town to pay him additional £5. But, if he have none but Latin scholars, then to allow out of his £5 what such Latin scholars' proportion cometh to. If he find scholars to increase, to keep school at the school-house from Ap. 1 to Oct. 1st, and the remainder of the year at his own house. Also, to catechize scholars and all other persons that are sent to him. June, 1696, the selectmen applied to Edward Goddard to teach school, to whom he replied, that if they would repair the school-house and give him £20 he would come; but the town did not accept the terms, and the town was fined for not having a school.

§ 226. Feb. 15, 1696-7. The town refused to have a grammar school, and ap-

pointed a committee to estimate the repairs of the school-house. Two of them reported that it would cost £3 or £4 to finish it well; the others reported that 30s. or 40s. would make it sufficient for use at present, and 40s. was granted. Feb. 26, the town voted money for a school; and, Mar. 29, they voted £10 and certain privileges, if Edward Goddard would keep school. Whether he then accepted does not appear in the records. Aug. 15, 1699, Edward Goddard agreed to keep the grammar school. May 24, 1700, voted, if Mr. Goddard will keep school the year ensuing, to grant him the remainder of the £10, granted for keeping school from Aug. 15, 1699, and £10 more for the year ensuing, and the rates from the "parents and owners of children."

§ 227. June 3, 1700, [Rev.] *Mr. Samuel Parris* agreed to keep school at his place of abode till some other is chosen. Sept. 3, 1700, Mr. Norcross was chosen to keep school for £10, and the usual rates from parents, and they to send one quarter cord of wood in the winter. At this time Mr. Norcross had been a schoolmaster forty-nine years, and was seventy-nine years old. Nov. 21, 1700, voted to keep the school the first and third quarters at the old school-house, and the second and fourth quarters in the middle of the town, and that the Farmers' Precinct, by paying £20, be freed from any other school charges this year. Also agreed with *Ames Angier* [grad. Harv. Coll., 1701] to keep school from Dec. 8; to have £30 in money, and those that send children to send one-fourth cord of wood. Mar. 2, 1701-2, agreed that the grammar school should be kept the second quarter at the house where old Father Ives formerly lived. Jan. 1, 1702-3, *Ames Angier* agreed to teach school half a year and no longer, to begin Jan. 25th. Ap. 23, 1704, *Nathaniel Gookin* [grad. Harv. Coll., 1703], agreed to keep school half a year, seven hours a day, for £15. Ap. 3, 1705, voted £30 for schools: £10 to be equally divided between the farmers and the westerly inhabitants, if it be improved for schooling; if not, to be for the use of the poor. Ap. 13, 1704, engaged *Nathaniel Gookin* to teach four months. May 10, 1706, the town "desired *Rev. Joseph Morse* to keep school, and be helpful to the minister, for £40, and 4d. per week for all who send their children," which he accepted conditionally. [See p. 374.] Dec. 13, 1706, school to be kept at *Joshua Bigelow's* house, west side of Beaver Brook, the next quarter.

§ 228. Jan. 22, 1707-8. *Thomas Robie* [grad. Harv. Coll., 1708] engaged to keep school half a year for £15, to begin 1st of March. 1st qr., seven hours; 2d qr., eight hours. Jan. 14, 1708-9. *Benjamin Shattuck* [grad. Harv. Coll., 1709] engaged to keep school, from Jan. 17th, half a year, for £15. He continued to teach in 1709, '10, '11, '12, '13, and '14. Nov. 30, 1714. Selectmen voted *Urian Angier* to be the schoolmaster, if the town approve, and town accepted, if he be found qualified. Nov. 20, 1714, at a meeting of selectmen, a committee reported "that they have been with the President of the College, and he informs them they cannot have any there that will keep school." Mar. 25, 1715. Selectmen agreed to pay *Mr. Robert Ward* [grad. Harv. Coll., 1719] £18, if he will keep school half a year ensuing. He was teacher again in 1716. May 10, 1717. Mr. Ward agrees to teach for £4, additional salary, and his year began May 11. May 19, 1718. *Benj. Fessenden* [grad. Harv. Coll., 1718] treated with to keep school one qr. for £10. Ap. 6, 1719. Voted £22 for *Benj. Fessenden*, and in 1720, '21, and '22. July 22, 1722, he was called to the ministry. Dec. 28, 1722. Ordered £12 for *Matthew Livermore* [grad. Harv. Coll., 1722], to be schoolmaster. Nov. 2, 1724. Ordered £22 for *Matthew Livermore*. June 7, 1725. Ordered to pay *Mr. L.* May 20, 1726, ordered £59, to pay him in full. Feb. 24, 1726-7, Ordered £30 for *Samuel Coolidge* [grad. Harv. Coll., 1724], schoolmaster. May 22, 1729. Ordered £15 to *Samuel Coolidge*. *David Stearns*, grad. Harv. Coll., 1728, master, 1729. *Nathaniel Harrington*, grad. H. C., 1728, master, 1733, '38, '46, '50, '68. *Samuel Nightingale*, grad. H. C., 1734, master, 1734. *Joseph Priest*, grad. H. C., 1734, master, 1735. *Josiah Pierce*, grad. H. C., 1735, master, 1736. *Jonathan Sewall*, grad. H. C., 1748, master, 1748. *William Jennison*, grad. H. C., 1724, master, 1750,

d. in Ap., 1750. *Samuel Coolidge*, grad. H. C., 1724, again master, 1751. *Josiah Swan*, grad. H. C., 1733 (?), master, 1758. *Thomas Phipps*, master, 1758. *Edward Russell*, grad. H. C., 1759, master, 1760. *Marshall Spring*, grad. H. C., 1762, master, 1763. *Joseph Willard*, grad. H. C., 1765, master, 1765. *Caleb Prentice*, grad. H. C., 1765, master, 1766. *Nathaniel Bond*, grad. H. C., 1766, master, 1767, English school. *John Hunt, Jr.*, grad. H. C., 1764, master, 1767, writing school. *John Stratton*, master, 1768, writing school. In 1767, five women's schools were provided for twelve weeks from Jan. 1st., viz., Samuel Cook's wife [Cook, 30, [?] his 2d wife]; Joseph Flagg's wife [? 63.]; Samuel Mason's wife [? of Newton]; Mrs. [Miss] Kezia Stone [49.]; and Mrs. [Miss] Hannah Bright [99.]

WATCHES.

§ 229. At a Court of Assistants, Ap. 12, 1631, "it was ordered, that there shall be a watch of four kept every night at Dorchester, and another of four at Watertown, the watches to begin at sunset," and "if any person shall shoot off a piece, after the watch is set, he shall forfeit 40s., or if the Court judge him unable [to pay], then to be whipped; the second fault to be punished by the Court as an offence of a higher nature." It appears, by Wintthrop [I., p. 74], that the ordering of the watch belonged to the Captain in the town where he resided, but where there was not a Captain resident, the duty devolved on the Constable. At the first meeting held by the General Court, after the introduction of a House of Deputies (May, 1634), it was "Ordered, that there shall be a watch of two at night kept in every plantation, till the next General Court." Mar. 9, 1636-7, it was, by the Court, "Ordered, that the military officers in every town shall provide that *watches* be duly kept most fit for common safety, and *wards* on the Lord's days; and that every person above the age of eighteen years (except magistrates and elders of churches) shall be compellable to this service." At the same time it was ordered that "every town shall provide a sufficient watch-house before the last of 5th month next, upon pain of £5." This order, about watches and wards, on the 2d May, 1638, was renewed and confirmed, for continuance from year to year. In May, 1640, it was ordered that "the ordinary watches and wards, in time of peace, shall be set by the constables in the several towns; but, in times of great danger of an enemy, the military officers shall take charge thereof." At a town meeting, Ap. 27, 1681, the military watches were turned into constable's watches, "until God's providence doe discover more eminent danger;" the night-watches, by the constables, to begin May 1st. The next month, June 11th, it was agreed that watches cease for the present.

§ 230. The information in the records respecting the watches in Watertown are very scanty. The meeting-house was sometimes used as the watch-house, which was also the depository of the ammunition of the town. In 1711, the old school-house, on School-house Hill, was ordered to be repaired for a watch-house.

§ 231. The homestall of John Wetherill was described as "bounded, W., with the *townhouse* and the [Pequusset] Common." Whether this was a watch-house, or what was its use, the records do not show. In the same neighborhood, at an early date, there was a *wolf-pen*, with a palisade about it. Perhaps the "town-house" was for the accommodation of a herdsman, who had the care of the cattle that were fed in common, on Pequusset Common, and the wolf-pen may have been used for enclosing the cattle at night against the attack of wolves. Jan. 10, 1647-8, the town voted "to give John Wetherill the palisade that enclosed the wolf-pen." By this time much of Pequusset Common had been divided into lots, and perhaps it had so nearly ceased to be used as a cow-common that the wolf-pen was useless. Soon after this the cow-pen was provided on the west border of the town. [See Section 156.]

§ 232. *Fairs.* By the Court, Sept. 6, 1638, it was "Ordered, that there shall be two fairs at Watertown, the one on the first Friday of 4th month (June), the other on the first Friday of 7th month (September)." At a town meeting, Mar. 30, 1639, it was ordered, that these "two Fairs at Watertown * * * shall be kept upon the Trayning-place." Fairs were, at that time, ordered to be held only in Salem, Watertown, and Dorchester. As there is no further notice of them in the colonial or town records, they probably soon fell into disuse.

SALARIES, WAGES, VALUATION, &c.

§ 233. A perusal of the copy of the original records of the town, inserted in the preceding pages [pp. 995, &c.], will show that there are very few notices of salaries or wages in them,—no mention of the Pastors' salaries until Dec., 1642, when the salary of Mr. Phillips was £67 13 4, and that of Mr. Knowles £40. The second levy, made by the Governor and Assistants, Nov. 1639, upon the several towns about the Bay (exclusive of Dorchester) was £60, for the two ministers, Mr. Phillips and Mr. Wilson, the half of which was for Mr. Phillips. This was probably for half a year. There are numerous penalties specified in the records for trespasses and violations of orders, and, in a few instances, fees or compensation for services. In 1638, the reward for killing a wolf was 5s.; in 1648, 1s. for killing a fox; and, in 1668, for killing blackbirds, 3d. per dozen. In 1640, the fee for executing a town order was 1s.; and 4d. upon the acre was allowed to the town surveyor "for surveying, plotting, and staking the lots upon the two plains, and the remote meadows." [See Sections 91-99.] The next mention of the Pastors' salaries was Jan. 33, 1647-8, when £120 was granted to Pastor Knowles and Pastor Sherman. This was very soon after the return of Mr. Sherman from Milford, and probably this sum was equally divided between them. This seems to have been the sum granted to the ministers for several years, and after the departure of Mr. Knowles, the whole sum was granted annually to Mr. Sherman. The "rate for the ministry" was usually a larger sum, as there might be some failures of payment, and the expenses of making and collecting it. In 1659 and 1660, £150 was allowed Mr. Sherman, and the next year the "ministers' rate" was the same sum, and in 1661 it was £160. From this date, until his decease in 1685, his salary was £140. This was a very liberal support for that day; but Mather says he had twenty-one children. After the settlement of Mr. John Bailey and his brother Thomas, the same sum was divided between them, viz., £80 to John and £60 to Thomas, with allowance for houseroom and firewood. After the organization of the two churches, and the settlement of Mr. Angier and Mr. Gibbs, £168 was annually divided equally between them, and after the settlement of Mr. Warham Williams and Mr. Storer, they each received the same salaries. It was the usual custom to allow the minister firewood in addition to his salary. Sometimes this was deducted from the salary, and sometimes the minister was required to take a large part of his salary in provisions, "town pay," at the rates fixed by the town prizer, or at the Court price. The first time that the term *salary* occurs in the records was in 1680, and then Mr. Sherman was to have one-fifth ($\frac{1}{5}$) of it in money. In 1687 the prices of "towns pay" for paying rates was, rye, 4s.; Indian corn, 3s.; and oats, 2s. In Jan., 1691-2, the prices were, rye and barley, 4s.; Indian corn, 3s.; and oats, 2s. In Feb., 1692-3, rye, 5s., barley, and barley malt, and Indian corn, 4s.—2s. in money to be taken as 3s. in grain. In 1697, oak wood was 7s., and walnut 8s., per cord. In repairing or rebuilding the mill-bridge, in 1706, carpenters, working in the water, were allowed 3s. per day, laborers on the land, 2s. 6d., and teams 5s. per day.

§ 234. The earliest mention of the pay of a schoolmaster was Jan. 6, 1650-1, when £80 was voted for Mr. Richard Norcross; and this continued to be the salary, with little variation, except as to manner of paying it, for about seventy-five years, with a few exceptions, about 1715 or '20, when it was £86. In some cases

tuition was to be paid for certain studies and certain scholars; and whatever was obtained in this manner was deducted from the sum the master was to receive from the town.

§ 235. On page 999 may be seen the valuation which was fixed, in 1642, upon the several kinds of lands and cattle for the purpose of taxation. In 1648, broken-up land was rated at 20s.; very bad [broken-up land], 15s.; unbroken, 10s.; meadow, 20s. It is remarkable that, in no appraisal or valuation for the purpose of assessments, do we find any mention of marsh lands, although, according to inventories, they were deemed to be from three to fivefold more valuable than any other lands. The following are the "invoices" of the town, at several dates, for the purpose of making assessments, with the number of "heads" (taxable persons):

		Taxable Persons.			Taxable Persons.
Aug. 30, 1658,	£7298,	. . . 158	Sept.,	1681, £6876,	. . . 171
Sept. 6, 1664,	7572,	. . . 154	Ap.,	1682, 6891,	. . . 172
Aug. 31, 1669,	6505,	. . . 192	Nov.,	1683, 5148,	. . . 174
Sept., 1678,	6691,	. . . 176	Sept.,	1685, 5441,	. . . 160

§ 236. In a levy of a tax of £30,000 upon the colony, in Nov. 1683 (after the union of the colonies of Plymouth and Massachusetts Bay), the share of Watertown was £224 16 6, being about 1-120th part of it. In Mar., 1694-5, a tax of 4d. in the pound was levied for building the new meeting-house, and amounted to £320 4s., which shows the total valuation or invoice to have been £19,212. This was little more than a year after the preceding levy upon the whole colony, and it shows the whole taxable property in the colony (of Plymouth and Massachusetts Bay) to have been at that time about £2,805,500.

PHYSICIANS.

§ 237. The information respecting the physicians of Watertown in early times, during the first hundred years, is very scanty, and their number very few. We have not discovered that any of the pastors of Watertown practised the healing art, which was not unusual in early times. James Sherman, of Sudbury, son of Rev. John Sherman, of Watertown, was a pastor and a physician, and two of his sons, John and Thomas, were physicians, and were said to be some time of Watertown; but in 1708 they resided in Springfield.

The earliest notice of any medical practice was Mar., 1630-1, when "Nicholas Knapp was (by the Court) fined £5, for taking upon him to cure the scurvy by a water of no value, which he sold at a very dear rate." Probably his only medical education had been, like that of his numerous followers, to study the credulity of human nature, and how he might most successfully dupe it. *Mr. Simon Eire*, "chirurgion," was the first physician of Watertown, where he resided about 10 years—1635 to 1645—when he moved to Boston. As there is no evidence that there was any other physician resident of Watertown for many years afterwards, it is not improbable that he sometimes visited it professionally, as he retained his estate there. But if there were no physicians, their place was supplied by some of the goodwives. Grace, wife of John Livermore, was an obstetrician, and she was sometimes summoned to Court, as a witness in cases, where she had acted professionally. In the County Court files is a petition of the Selectmen of Watertown, dated 1690, in which they say that S. G. came from Cambridge to Watertown "to the house of Ellis Barron, whose wife had skill in matters of surgery." The next physician after Dr. Eire was *Dr. Philip Shattuck*, who probably practised there from about 1670 to 1722. He resided in the northeast part of Waltham. *Dr. Palgrave Wellington* was his cotemporary, being only five years younger than Dr. Shattuck. He resided on the Cambridge Road, on or near the lots of G. Church and W. Woolcot. He d. 1715. *Dr. Richard Hooper* was a cotemporary of Doctors Shattuck and Wellington, and resided at the east of Mount Auburn. He died early in 1690. His son *Henry*

was a physician of Watertown a few years, and about 1723 he moved to Newport, R. I. *Dr. Josiah Converse*, from Woburn, settled in Watertown, probably about the time of the decease of Dr. Shattuck, and the removal of Dr. H. Hooper. We have not ascertained where he resided, but perhaps it was the residence afterwards occupied by his nephew, pupil, legatee, and executor, Dr. Marshall Spring. He died in 1774, after a residence of probably nearly 50 years. See Spring [60], p. 444, and Bond [323], p. 62.

LAWYERS.

§ 238. There was no lawyer, resident of Watertown, for the first 120 or 130 years after its settlement, and our information respecting those of later times is too scanty to be inserted here, if we were attempting a history of such times.

INNKEEPERS AND LICENSED RETAILERS AND TRADERS.

§ 239. Innkeepers were licensed by the General Court or Courts of Assistants until the organization of County Courts, and they were sometimes appointed or nominated by the selectmen. The following list is undoubtedly defective. The locality of many inns in the following list has not been ascertained.

Sept., 1635. The Court licensed *John Masters* to keep an ordinary, and he was discharged, June 4, 1639, a few months before he died. He had probably moved to Cambridge previous to the date of his license, but the record does not show it.

June 6, 1637. By the Court, *George "Munnings"* is fined 20s. for selling beer and keeping a house of entertainment without license." This was about six months after he returned from the expedition to Block Island with the loss of an eye. The next November, "Munnings, of Watertown, is (by the Court) put down from keeping an ordinary, or house of entertainment; and it is referred to Watertown to choose another." [See p. 859.]

Mar. 12, 1637-8. *John Loveran* [Loverill in the Court Record] is, by the Court, "allowed to sell wine and strong water" at Watertown. His homestall was a little distance east of the Bridge, extending from Mount Auburn Street to the river.

June 1, 1641. *William Knapp*, for selling beer two years unlicensed, was fined £5. He resided on the S. side of Belmont Street, W. of the graveyard.

Nov. 4, 1646. "*Mrs. Margaret Howe* [wid. of Edward] and *Nathaniel Treadway* [her son-in-law] are granted liberty to draw two butts of wine, which they received for debt, and cannot put off in the butts." [See the Map.]

Nov. 2, 1649. *Thomas Wincoll* was, by the selectmen, allowed to keep a house of entertainment.

Oct. 1654. *Lieut. Richard Beers*, upon the recommendation of several freemen of Watertown, was licensed by the County Court to keep an ordinary. His license was repeatedly renewed, and probably continued until his decease in 1675. His homestall, in 1644, bordered on the S. W. shore of Fresh Pond. Previous to 1644, he had purchased another homestall on the south side of Mount Auburn Street, not far west of the old graveyard.

☞ The County Court Records, from Oct., 1663, to Ap., 1681, are lost, or were not discoverable at the time our researches were made, and it has not been ascertained what licenses were granted during that time.

John Nevinson, licensed, in 1685, to keep an ordinary, and until his decease, Jan., 1695. He was succeeded by his son-in-law, *Samuel Hastings*, for a short time. Mr. Nevinson's widow, after the decease of her second husband, with whom she lived only a few months, obtained a license in 1698, and continued to keep an ordinary until 1717; probably in the neighborhood of Mount Auburn.

Caleb Church, licensed in 1686, and until 1711; resided on the N. side of Maine Street. He sold the land, Ap. 23, 1712, to *Thomas Learned*. See *Learned*, below

- David Church*, licensed in 1687 and '88. [See G. Church, on the map.]
- Thomas Woolson*, 1686, and until 1708; supposed to reside on the Sudbury Road, in Watertown Farms [Weston], at a short distance west of the meeting-house.
- John Chadwick*, licensed in 1693, and again in 1695.
- Mrs. Hooper* [wid. of Dr. Richard], licensed in 1693; E. of Mount Auburn.
- Daniel Benjamin* [19.], licensed, 1694, until 1699, "to sell liquors in-doors."
- Ebenezer Prout*, licensed, in 1695, and license renewed, to "sell liquor in-doors."
- Samuel Parris*, licensed, in 1700 and in 1701, as a "retailer out of doors," i. e. a trader; north side of Maine Street, west of the Town Hall.
- Samuel Bigelow* [22.], licensed, 1701, and until 1716, to keep a house of entertainment.
- Abraham Brown* [18.], licensed in 1709, and continued four years; where his grandson, Jonathan Brown, Esq., and great-grandson, Major Adam Brown, afterwards lived.
- Thomas Learned* [42.], licensed in 1712, and until his decease in Dec., 1729. It was on the lot where the Spring Hotel has been built. He was succeeded by his widow, *Mary*, who kept it until 1764; then kept two years by her son, *Abijah Learned*; then by *Benjamin Prentice*, 1767-69; then by her son, *Bezaleel Learned*, in 1770-71. See C. Church, above.
- Thomas Coolidge* [107.], licensed, 1713, until 1737, when he was succeeded, for a few years, by his widow, *Mary*, who was, in 1744, succeeded by her son, *David Coolidge*, who continued the business until 1755; supposed to be where W. F. Gay now resides.
- Ebenezer Wellington* [17.], licensed, 1715-17.
- Mrs. Mary Brewer*, of Weston, wid. of John, licensed in 1717.
- Daniel Ball* [10.], licensed in 1717; probably on Waltham Plain.
- Wid. Ruth Child* [77.], licensed 1717 and '18; (?) near the bridge, south side of the river.
- Thomas Harrington* [141.], of Waltham, licensed, 1719 to 1737.
- Thomas Saltmarsh*, licensed, 1735 to 1769; not far west of Mill Bridge, probably that since known as the Wellington Tavern.
- Capt. John Brown* [77.], licensed, 1737 and '38; probably on Belmont Street, where Gen. Jonathan Coolidge afterwards lived.
- Nathaniel Harris*, licensed, 1738 to '49, as a retailer (trader).
- Jonathan Gardner*, licensed, 1739.
- John Hunt*, licensed, as a retailer (trader), in 1740, and in 1769, was succeeded by his son *John*. His son, *Samuel Hunt*, licensed as a trader, 1758 to '64.
- Nathaniel Coolidge* [148.], licensed, 1744-46; son *Nathaniel*, licensed, 1764-70, and kept near the south end of Mill Bridge.
- Jonathan Bemis* [52.], licensed, 1745 and '46.
- Cornelius Waldo*, licensed, as a trader, in 1750, until 1771; supposed to be on the Dr. Hooper place.
- William Baldwin*, licensed in 1753.
- John Remington*, licensed, as a trader, in 1753, and continued until 1765.
- Hannah Livermore* [? 54.], licensed, 1754 to '61, to sell tea, coffee, china, &c.
- Jonas White*, licensed, as a trader, 1764 to '70.
- Edward Richardson*, licensed, 1764 to '71; at the junction of Belmont and Mount Auburn Streets; since known as the Bird Hotel.
- Jonathan Capen*, licensed, 1769-71.
- Thomas Wellington* [62.], licensed, 1770-71; supposed successor of Thomas Saltmarsh.
- Ezekiel Hall*, licensed, 1770-71.
- Capt. Abner Craft*, licensed, 1772.
- In Weston and Waltham, after their separation from Watertown, there were many inkeepers previous to the end of the last century; but the list obtained is too defective to be inserted here. See Baldwin, Brewer, Woodburne, Gleason, Townsend.

APPENDIX II.

THE following is a catalogue of the authors or works quoted or referred to in the foregoing pages. Others, however, are referred to in the course of them, but in such a manner that it is unnecessary to insert them here. Indeed, some may think this catalogue superfluous; but the work may come under the notice of others, not so well acquainted with the sources of information, who may find it convenient for reference.

- Farmer.* A Genealogical Register of the First Settlers of New England. By John Farmer, 1829.
- Winthrop.* The History of New England from 1630 to 1649. By John Winthrop, Esq., first Governor, &c. Edited by Hon. James Savage, 1825 & 1826. 2 vols.
- Geneal. Reg.* The New England Historical and Genealogical Register. Published quarterly under the direction of the Historic-Genealogical Society. 9 vols.
- Barry.* The History of Framingham, Mass.; with a Genealogical Register. By Rev. William Barry, 1847.
- Shattuck.* A History of the Town of Concord, Mass., and of the adjoining towns of Bedford, Acton, Lincoln, and Carlisle. By Lemuel Shattuck, Esq., 1835.
- Francis's Hist.* An Historical Sketch of Watertown in Massachusetts, from the first settlement of the town to the close of its second century. By Rev. Convers Francis, D.D., 1830.
- Camb. Church Gathering.* A Discourse on the Cambridge Church Gathering in 1636; with an Appendix containing Rev. Jonathan Mitchell's record of the church during his time, 1650 to 1668. By Rev. William Newell, 1836.
- Ward.* History of the Town of Shrewsbury, Mass.; with a Family Register. By Andrew Henshaw Ward, Esq., 1847.
- Ward Fam.* Ward Family; Descendants of William Ward, &c. By Andrew Henshaw Ward, Esq., 1851.
- Butler.* History of the Town of Groton, including Pepperell and Shirley; with Family Registers, &c. By Caleb Butler, Esq., 1848.
- Coffin.* A Sketch of the History of Newbury, Newburyport, and West Newbury. By Joshua Coffin, A.B.S.H.S., 1845.
- Mitchell.* History of the Early Settlement of Bridgewater, Mass., including an extensive Family Register. By Hon. Nahum Mitchell, 1840.
- Locke Fam.* Book of the Lockes: A Genealogical and Historical Record of the Descendants of William Locke, of Woburn, Mass.; with a copious Appendix. By John Goodwin Locke, Esq., 1853.
- Prentice Fam.* The History and Genealogy of the Prentice or Prentiss Family in New England. By C. J. F. Binney, 1852.
- Farrar Fam.* A Discourse, occasioned by the Centennial Anniversary of Hon. Timothy Farrar, LL.D. By T. F. Clary. To which is added, A Memoir of the Farrar Family. By a Member of the N. E. Hist. Gen. Society, 1847.

- Camb. Epitaphs.* Epitaphs from the Old Burying Ground in Cambridge, Mass.; with Notes. By William Thaddeus Harris, Esq., 1845.
- Reg. Abbot Fam.* A Genealogical Register of the Descendants of George Abbot, of Andover; George Abbot, of Rowley; Thomas Abbot, of Andover; Arthur Abbot, of Ipswich; Robert Abbot, of Branford, Conn.; and George Abbot, of Norwalk, Conn. By Rev. Abiel Abbot, D.D., and Rev. Ephraim Abbot, 1847.
- Hist. of Glastenbury.* Glastenbury for Two Hundred Years; a Centennial Discourse; with an Appendix. By Rev. Alonzo B. Chapin, D.D., 1853.
- Deane's Scituate.* History of Scituate, Massachusetts. By Samuel Deane, 1831.
- Mem. of the Morses.* Memorial of the Morses, containing the History of seven Puritans of the names of Morse and Moss, &c.; with a catalogue of ten thousand of their descendants. By Rev. Abner Morse, A.M., 1850. Also a supplement to the same by the same, 1851.
- Hist. Worcester.* History of Worcester, Massachusetts, from its first settlement to 1836. By William Lincoln, 1837.
- Wor. Mag.* The Worcester Magazine and Historical Journal. 2 vols. Published in Worcester in 1825 and 1826.
- Hist. New London.* History of New London, Conn., from the first survey of the coast, in 1612 to 1852. By Miss Frances Manwaring Caulkins, 1852.
- Hist. Norwich.* History of Norwich, Conn., from its first settlement in 1660 to Jan. 1845. By Miss F. M. Caulkins, 1845.
- The History of New Ipswich,* from its first grant in 1736 to 1852. By Frederick Kidder, Esq., and Dr. A. A. Gould, 1852.
- Mass. Col. Records.* Records of the Governor and Company of the Massachusetts Bay, in New England. Printed by order of the Legislature, and edited by N. B. Shurtleff, M.D. 6 vols. Royal quarto. 1853 and 1854.
- Mass. Hist. Coll.* Collections of the Massachusetts Historical Society. 31 vols.
- Hutchinson's History of the Colony of Massachusetts Bay,* and his State Papers.
- Hazard's Collections of State Papers* and other Authentic Documents, 1792.
- History of Connecticut.* By Benjamin Trumbull, D.D. 1818.
- Conn. Col. Records.* The Public Records of the Colony of Connecticut prior to the Union with New Haven Colony in May, 1665: published in accordance with a resolution of the General Assembly, and edited by J. Hammond Trumbull. 2 vols. 1850 and 1852.
- Jackson's Hist. of Newton.* A History of the Early Settlement of Newton, Mass., from 1639 to 1800, with a Genealogical Register of its Inhabitants. By Francis Jackson, Esq. 1854.
- A History of Rutland,* Mass., from its First Settlement; with a Biography of its First Settlers. By Jonas Reed. 1836.
- Hist. of Ipswich.* History of Ipswich, Essex, and Hamilton. By Rev. Joseph B. Felt. 1834.
- Annals of Salem.* By Rev. Joseph B. Felt. 2d edition, 2 vols. 1845 and 1849.
- Hinman.* A Catalogue of the Names of the Early Puritan Settlers of Connecticut. By Royal R. Hinman, Esq. 4 Parts. 1852-54. pp. 684.
- History of Spencer,* Mass., including a Brief Sketch of Leicester. By James Draper. 1841.
- Mather's Magnaliæ.* 2 vols. Hartford. 1853.
- The History of Lynn,* including Nahant. By Alonzo Lewis. 1844.
- The History of Holden,* Mass. By Samuel C. Damon. 1841.
- History of the Town of Natick,* from 1650 to 1830. By William Bigelow. 1830.
- Historical Discourse at Brookfield,* Mass., Nov., 1828. By Rev. Joseph I. Foot.
- The History of Ancient Woodbury,* Conn. By William C. Cothren, Esq. 1854.
- Annals of Newtown,* L. I., N. York; containing a History of its First Settlement, with Family Memorials. By James Ricker, Jr.

- Haven Genealogy.* The Genealogy of the Descendants of Richard Haven, of Lynn, Mass. By Josiah Adams, Esq. 1843.
- Haven's Address.* An Historical Address, delivered in Dedham, Mass., Sept. 21, 1836, at the Second Centennial Anniversary of the Incorporation of the Town. By Samuel F. Haven.
- Sketch of the History of Attleborough.* By John Daggett. 1834.
- Hundred Boston Orators.* The Hundred Boston Orators, appointed by the Municipal and other Public Bodies, from 1770 to 1852; comprehending Historical Gleanings, &c. By James Spear Loring. 1853.
- Young's Chronicles.* Chronicles of the First Planters of the Colony of Massachusetts Bay, from 1623 to 1636. By Rev. Alexander Young, D.D. 1846.
- The American Loyalists.* Biographical Sketches of Adherents to the British Crown in the War of the Revolution. By Lorenzo Sabine. 1847.
- The History of Rowley,* anciently including Bradford, Boxford, and Georgetown, from 1639 to 1840. By Thomas Gage.
- Mendon Association.* A Centennial History of the Mendon Association of Congregational Ministers, &c., with Biographical Sketches. By Rev. Mortimer Blake. 1853.
- Buddington's History.* A History of the First Church of Charlestown, Mass, with Notes. By William I. Buddington. 1845.
- The History of Charlestown,* Mass. By Richard Frothingham, Jr., Esq. 1845-47. pp. 312.
- The Ancient Historical Records of Norwalk,* Conn., with Plans, and a Genealogical Register. By Rev. Edwin Hall, D.D. 1847.
- The History of Scarborough.* By W. S. Southgate.
- The Bellows Family.* Historical Sketch of Col. Benjamin Bellows, founder of Walpole, N. H., with an Address, and Biographical Sketches of some of his Descendants. By Rev. Henry W. Bellows. 1855.

APPENDIX III.

PEDIGREE OF LAWRENCE.

ARMS.—Ar. a Cross raguly gules.

Compiled from the *Herald's Visitations, Inquisitions Post-Mortem, Deeds, Charters, Wills, Parish Registers, and other Original Manuscripts.*

[SEE NOTE * p. 810.]

BY HORATIO G. SOMERBY, ESQ.

SIR ROBERT LAWRENCE=Amphilbus, dr. of Edward Longford, Esq.

of Ashton Hall, Lancashire, living in 1454. [For his Pedigree, see [L]]

Sir James Lawrence. Robert. Nicholas, of Agercroft,=

John Lawrence, fourth son, according to a pedigree of the Lawrences of= Ashton Hall. From this John are descended the Lawrences of Suffolk. He d. in 1461. Motto of those of Suffolk, *Floreat ut Lauries.*

Thomas Lawrence, of Rumburgh, Co. Suffolk. Will dated, July 17, 1471; = proved, Nov. 6, 1471; deposited at Ipswich, Co. Suffolk.* Desires to be buried in the Cemetery of St. Michael, at Rumburgh; mentions sons John and Richard; also his grandchildren, children of son John; speaks of his lands in Rumburgh, South Elmham, and Spettishall.

John Lawrence, of Rumburgh, named in his father's will. His own will = dated July 10, 1494; proved in the Bishop's Court of Norwich, Aug. 3, 1504; desires to be buried in the Church of St. Michael at Rumburgh; gives to the poor of Rumburgh, Spettishall, Wissett, and Holton. To wife Margery, certain tenements, called "Brayes," "Craines," and "Gooles."^h

Robert Lawrence, of Rumburgh; named in the wills of his father and = mother; to have the tenements called "Gessillys" and "Brayes."

John Lawrence, of Rumburgh, named in his grandmother's will. After = the death of his father, to have the tenements called "Gessylls" and "Brayes." His will, dated Jan. 27, 1550; proved at the Bishop's Court of Norwich, Sept. 23, 1559; desires to be buried at Rumburgh, near his kin= folk.

Thomas,
William.
Edmund.

Richard, named in his father's will; = successor of the Lawrences of St. Ives, Hertfordshire.

Margery —; her will, dated Dec. 5, 1504; = proved, Ap. 20, 1507; deposited at Ipswich; desires to be buried near her husband; mentions tenements called "Craines," "Gessilla," and "Brays."

Robert Lawrence, mentioned in her mother-in-law's will.

named in her husband's will, to have the tenement called "Craines."

SIR ROBERT LAWRENCE had arms con= ferred on him by Richard I. for his bravery in sealing the walls of Acre, A.D. 1191.

Sir Robert Lawrence, = dau. of = Traf= ford, Esq., of Lancel= shire.

James Lawrence = Matilda, dau. and heir of John de = Washington.

John Lawrence = Margaret, dau. of Walter Chesford.

John Lawrence = Elizabeth, dau. of = Holh, of = Stablesy, Co. Lancashire.

Sir Robert Lawrence = Margaret Holden, of Lancel= shire.

Sir Robert, Ashton Hall, living in 1454.

APPENDIX IV.

ILLUSTRATIONS OF THE MAP OF THE EARLY TOPOGRAPHY OF WATERTOWN (PROPER).

In Sections 84 and 85, pp. 1020 and 21, are pointed out some of the difficulties to be encountered in attempting a plan or map of the original divisions and allotments of land. These were by no means exaggerated. But, having discovered that we had fallen into one or more important errors, regarding early localities, through the hastiness of our conclusions from inadequate premises, we were induced to enter upon a more thorough investigation in order to rectify them, but without the expectation of succeeding so well, or proceeding so far, that the result could be offered in the form of a map of ancient Watertown. The success of the intricate and perplexing labor having far exceeded our expectation, the result of these researches is here presented in a map, with some explanations.

As no record of that period gives the dimensions of a lot, but only the quantity of land, and that "by estimation," not by measurement, all that is attempted in the map, is, to show the size of the lots, and their relations to each other, to roads, and to the natural boundaries. It is evident that the *estimation* of the quantity of land in each lot was not always accurate, as, in many instances, the same lot, in different descriptions or records of it, is stated to contain different quantities of land. If their exact outlines could be discovered, they would probably exhibit very many discrepancies between them and those on this map. This is, however, of comparatively small importance, if their size and position are determined. That such is the case, generally, with few and unimportant exceptions, we are entirely satisfied.

In the course of the following explanations, the term *grant* is applied to lots where the title was derived directly from the town, not by purchase, and the holder was the first individual owner. The term *possession* is applied to lots obtained by grant, purchase, gift, or inheritance, and the holder of it was not always the first owner. In the early schedules there is only one instance of a lot *purchased of the town*, and that was the 47 A. lot purchased by Mr. Nathaniel Biscoe, the rich tanner. In later times, there are many instances of such purchases.

It may be seen, in the copy of the original records, p. 995, &c., that there is frequent mention of *general enclosures*, and *fencing in common*. The same may be seen in the succeeding town records, and it was many years before they were discontinued. The first mention of general enclosures occurs very early (Jan. 3, 1634-5), and it was afterwards (May 30, 1643) ordered, that "a fence with 4 rails, or any fence as good, is counted sufficient." They generally had distinct names, and each was surrounded with roads, or some natural boundary.

Pond Field was bounded E. by Fresh Pond; W. by School Street; S. by Belmont Street; and N. probably by the Road to the Pond.

Meadfield was bounded S. by Belmont St.; E. by Common St. (Pequusset Road); W. by Lexington St. (road to Concord). It was probably so named because it included Pequusset Meadow.

Bowman's Field was bounded N. by Belmont St.; S. W. by Orchard St., and E. by Bowman's Lane. These names indicate the respect entertained for Mr. Bowman.

Jennison's Close, or Field, was bounded W. by Bowman's Lane; N. by Belmont St.; E. by School St.; S. by Mill St. (Mount Auburn St.). Capt. Jennison's homestall was much larger than any other in this tract.

How's Field was bounded S. by Sudbury Road (Main St.); W. by Lexington St.; N. by Orchard St., and E. by Bowman's Lane and Mill St. (Mount Auburn St.). Elder Edward How was the largest proprietor in this tract. It included the east range of lots in the Town Plot.

Pound Field was bounded N. by Mill St. (Mount Auburn St.); S. and W. by Bank Lane; E. by Grove St. The town pound was anciently in it, near the N. E. corner. About 1687, the pound was at the S. E. corner of Lexington and Belmont Streets.

The Hither Plain [see § 91], for several years, had a general enclosure, and the *cartway betwixt lots* [Pleasant St.] was not a fenced road. It is, indeed, highly probable that few, if any of the lots, in the Hither and Further Plains, were ever fenced according to the original allotments. Early and frequent changes of ownership occurred, before the lots began to have distinct fences, and two or more lots were often consolidated into one.

There is some obscurity about the arrangement of lots in Dorchester Field, and the delineation of them is not entirely satisfactory. It probably had no precise boundaries. The following lots, in the schedule of grants, are described as "in Dorchester Field," viz., E. Child, 10 A.; J. Loveran, 8 A.; W. Jennison, 6 A.; John Bernard, 6 A.; R. Tucke, 2 A. At a later date, the large homestall of John Benjamin was said to be in Dorchester Field.

There is a small tract of land between Dorchester Field and the homestall of Nathaniel Foote, which it has been found very difficult to delineate, according to the lines or divisions of the original grants, owing to the repeated changes of ownership, and the defective descriptions of boundaries. Jeremiah Norcross was not a grantee; but, in 1643, he owned a homestall of 26 A. in that locality, made up of land bought of John Page, Robert Tucke, Richard Amler, and Jacob Logan (? Seger). This land of Mr. Norcross included the 14 A. homestall granted to Edmund Mason, and the 7 A. homestall granted to Robert Tucke. It is conjectured that Page and Amler bought the land of Mason, and sold it to Norcross, and that Seger had a 5 A. lot, obtained by grant or purchase, which he sold to Norcross, and which would complete the 26 A. homestall. Not long afterwards, Mr. Norcross purchased of H. Cuttris the 16 A. homestall granted to N. Foote.

There are a few instances, in the schedules of grants, where the same lot appears to have been granted to two persons. In these cases it is probable that the first grantee relinquished it to the town, exchanging it for another, or perhaps failed to comply with the terms of the grant. One instance of this is the lot north side of Belmont Street, next east of R. Holden. It was granted to Edmund Sherman (who left Watertown in 1637) and to Bryan Pendleton. From the latter it passed successively to N. Busby, John Stebbins, J. White, J. Coolidge, and Rev. John Sherman, who purchased the lots of J. and R. Holden.

We have not attempted to delineate all the lots of *marsh land*. In most instances, they are described as bounded S. or S. E. by the river, and N. or N. W. by Bank Lane, with the omission of the boundaries on the other two sides. As these lots were not residences, it is the less interesting to determine their outlines and localities. There were 21 lots of marsh granted, amounting to 62½ acres. The largest lot (10 A.) was that of Dea. Ephraim Child, bounded S. E. by the river, and N. W. by Bank Lane. It was probably opposite to his first residence, situated at the southwest corner of Water Street and Bank Lane. Two lots of marsh were granted to Elder Richard Brown. The first (3 A.), which he sold early to Simon Stone, was opposite to his first homestall, E. of Mount Auburn, which he sold to R. Wellington.

There were three 2 A. lots of marsh between the homestall of Nathaniel Foote and the river. The easternmost was that granted to N. Foote. The next was that of John Smith. The other was the second lot granted to R. Browne. Pine Marsh was the first marsh at the E. or S. E. of Dorchester Field. Three 2 A. lots in it were granted to Robert Lockwood, Nicholas Knapp, and Thomas Rogers. Several of the marsh lots may be seen delineated on the map.

It has been stated in § 81, that Pequusset Meadow was divided into numerous small lots. They were situated in a range, beginning at John Flemming's homestall, and extending north to Pequusset Common, in the following order. Those marked (*) denote an original grantee. *J. Doggett, 2 A., sold to John Flemming; J. Bisco, 3 A.; *J. Lawrence, 2 A.; *W. Hammond, 3 A.; *H. Goldstone, 2 A., passed to his son-in-law, Henry Bright, Jr.; *N. Bowman, 2 A.; *Isaac Cummings, 2 A., sold to Henry Kemball, Jr.; T. Boyden, 3 A.; *E. James, 3 A.; *I. Sterne, 2 A.; *J. Warren, 3 A.; *J. Simson, 2 A., passed to G. Parkhurst, who m. his wid., and who sold it to W. Hammond; *H. Bright, Jr., 2 A., sold to W. Hammond; N. Busby, 4 A.; S. Freeman; S. Eire.

By referring to § 27, it will be seen that some locality or region, at the east of Mount Auburn, at a very early day, was called "*The Town.*" Whether this was applied to some point, or what was its extent, the records do not show, and we are left to conjecture. The tract of land at the east, north, and south of Mount Auburn, was undoubtedly the one where the plantation was begun in the summer of 1630, and it is conjectured that the lot, marked G. Phillips on the map, at the junction of Cambridge and Water Streets, was the centre, and the point from which distances were reckoned. Sir Richard Saltonstall's homestall was bounded N. W. by land of Mr. Phillips, and it is supposed that Mr. Phillips's lot extended northwestwardly to the junction of Cambridge and Water Streets; that after "the new meeting-house" was built near the Old Graveyard, Mr. Phillips sold two parcels of the lot to Mr. E. Angier and H. Pelham, Esq. It appears by the schedules of possessions, that the lots of Pelham and Angier were purchases and not grants, and that in the list of Mr. Phillips's grants and possessions (in the same schedule, made out a short time before his decease), he had no lot bounded S. E. by land of Sir Richard. It was not unusual for lots to be described by their original or early boundaries, after the adjoining lands had changed owners; and thus Sir Richard's lot, after it had passed to his son Samuel, was described as bounded N. W. by G. Phillips. It is our conjecture (supported by plausible reasons, but without positive data), that the first house of worship was built on that lot, at the junction of Cambridge and Water Streets, on the map marked G. Phillips; and that if any burials took place before the opening or appropriation of the Old Graveyard, they would be in that lot or its immediate neighborhood.

By consulting the map, it will be seen that a great portion of the lots, east of Mount Auburn, were not held by grantees, but by purchasers, and at the time the schedules were made out (about 1643) many of those grantees, whose names are marked on the lots, had sold them, and moved to other larger lots, situated farther west, or had migrated from the town. R. Sceley, J. Livermore, R. Feake, A. Ward, R. Abbot, and B. Windes, had moved to Connecticut; A. Shaw to Dedham; Mr. Phillips, R. Browne, A. Browne, J. Firmin, J. Warren, E. Child, I. Sterne, W. Hammond, and J. Lawrence, had moved to other lots, which may be seen on the map. From the situation of the homestall lot of Leonard Chester, and the time of his arrival, it is presumed that it was not a grant, but a purchase; and it may have been the grant made either to John Masters or Capt. Patrick, who moved to Cambridge about the time of Mr. Chester's arrival. It will be seen on the map that the lot, marked as a grant to *John Hayward*, contained 24 acres. This is so much larger than any other grant made in that region, that it seems to require some explanation. Our presumption is that a part of the 24 A. was granted to him; that he purchased one or two other contiguous lots, which had been granted to those who

left the town early, and that then, in the schedules, as in the case of J. Norcross, the whole was inserted as one lot. On the map may be seen two lots, on Bank Lane, near Water Street, marked *Edward Goffe*, who was a purchaser and not a grantee. These were undoubtedly grants to some of the planters of 1630, and it is not unlikely that one of them was made to W. Jennison; for his large 50 A. homestall was among lots granted at a later date than the time of his settlement. The lots east of Mount Auburn are sometimes styled Planting Land, and there is reason to believe that all the lands in this region, fit for planting, were granted the first year. There were two or more lots granted at a later date, as those of Simon Stone and R. Wellington; but these were among the rough grounds of Mount Auburn, and were unsuited to planting or tillage.

The tradition is, that *Mr. George Phillips* resided in a house opposite to the Old Graveyard, very near the "new meeting-house," and this is so probable and plausible, that his supposed dwelling is marked on the map. Yet there is good reason to question its correctness.

Mr. Phillips's homestall in the Town Plot, at the corner of Orchard and Lexington Streets, was the first in the list of his possessions; in that schedule of grants, which was completed a short time before his decease. In other instances, almost without exception, a man's homestall, where he resided, is placed first in the list of his possessions. It is also to be observed that, if he lived on this lot, he was the next neighbor of his co-pastor, Mr. Knowles, whose homestall was on the other side of Orchard Street, and it was only half a mile north of Mr. Carter's residence. There is no doubt but that the widow of Mr. Phillips, and his son Jonathan, lived on this lot. In the Inventory of Jonathan, 1704, is, $\frac{1}{2}$ the dwelling-house that was his father Phillips. If Mr. Phillips moved to this lot, he only complied with the terms, on which it was granted, that he should "build and dwell upon it." In the next place, the lot of Mr. Phillips, upon the Meeting-house Common, is the last in the list of his grants, and it is not called a homestall, but only "fifteen acres of upland."

The 12 A. homestall of *Thomas Mayhew*, may be seen on the map, near the bridge. May 6, 1654, he sold this (then called his orchard, containing 9 A., and occupied by John Bush), to Nicholas Davison, of Charlestown, for all his (D.'s) sheep, cattle, and land in Martha's Vineyard, except the land (1000 A.) which he received of Mayhew for the Oldham Farm. Nov. 3, 1655, Davison sold this Mayhew homestall to John Fuller, of Cambridge, for £44. Fuller sold it to *Richard Sanger*, May 15, 1657, for £46. From Richard Sanger, it passed to his son John; then to his grandson David; then to his great grandson William; then to his gr. gr. grandson Richard, who now occupies a part of it. A part of it was formerly the residence of Rev. Dr. Francis, and a part of it is now the residence of Dr. Hiram Hosmer.

Mr. John Oldham left Watertown and died before any schedule of grants or possessions was made out, and his name is not found in them. It is very probable that the 60 A. homestall, bought by John Benjamin, was his residence. [See p. 1037.] The Wear is supposed to have been opposite to this lot.

Richard and Abraham Browne settled on adjoining lots on Bank Lane, east of Mount Auburn, but they both moved very early to other lots, as may be seen on the map. Richard very early sold his first homestall to R. Wellington, and his adjoining marsh to Simon Stone; John Train bought his last homestall. *Abraham Browne* retained his first homestall and adjoining marsh, until after the summary of possessions was made out.

In the Inventory of *Abraham Browne* [p. †125], his homestead was reported to contain 60 A. Unless there was a mistake in the estimate of the quantity of his land in the early schedule, his homestead, in this Inventory (besides the 40 A. between Main St. and Pleasant St.), must have included the 10 A. on the S. side of Pleasant St., granted to him and to John Browne, and 10 additional acres contigu-

ous thereto; for the additional 20 A. to the ancient homestall, could be obtained in no other direction [see § 94]. That a part of the estate was on the S. side of Pleasant St., is shown by the following mortgage. Whether this was the grant made to John Browne, has not been ascertained. Ap. 13, 1697 [soon after the settlement of the estate], Abraham Browne mortgaged to Caleb Church, 6 A. adjoining Dirty Green, bounded E. by C. Church (the owner of Dirty Green); N. by highway to Beaver Plain; W. by Abraham Browne; S. by Charles River. This lot of A. B. soon passed to Edward Goddard; for, on the 22 Mar. 1705-6, Caleb Church mortgaged "12 acres of pasture, called Dirty Green," bounded S. and E. by the river; W. by Edward Goddard; N. by highway (Pleasant St.). It has not been ascertained how this place acquired the name of Dirty Green, and Dirty Place.

Upon the final settlement of the estate in 1694 [see p. †125], Capt. Abraham Browne, in behalf of himself and other heirs of his father, Jonathan, bought of the other heirs their rights in the estate. The records do not show how the estate was divided among the heirs of Jonathan, after this purchase; but some information, not very exact, is derived from succeeding transactions. The western part was assigned to Abraham, the eldest son, and ex'r of Jonathan. He built upon it, and it has never ceased to be owned by his descendants. The eastern and larger portion, was assigned to the widow, Mary, and the younger sons. A large part of this, soon passed out of the possession of the family, but was recovered after the lapse of about 28 years, and held in the family until about 1808.

Mar. 30, 1703, wid. Mary, and her sons, William and Benjamin, for £192, sold to Samuel Barnard 25 A., bounded N. by Sudbury Road, and land of Mary Browne; W. by Mary Browne, and partly by land of Serjt. John Fiske. By this deed, it appears that she retained some of the land assigned to her and her younger sons, and a subsequent deed shows its amount. Mar. 13, 1705-6, William and Benjamin B., sold to their brother Abraham, 9½ A., bounded N. by Sudbury Road; W. by land of Abraham Browne; E. and S. by Samuel Barnard. On the same day, Abraham signed to his brothers William and Benjamin, a quitclaim of his right in the land which they had sold to Barnard. By a deed dated Dec. 23, 1715, Capt. Abraham Browne conveyed to his son Jonathan, 14 A. "in easterly part of my estate," bounded E. by Samuel Barnard; S. by S. Barnard and John Fiske; N. by highway; W. by Abraham Browne. Mar. 18, 1730-1, James Nutting, of Wrentham, gunsmith, and Mercy, his wife, and Esther Barnard, spinster (both daughters of Samuel Barnard), for £450, sold to John Browne (youngest son of Capt. Abraham), house, barn, shop, and 24 A. land, bounded N. by highway; W. by Jonathan and Samuel Browne, who held, by deed and legacy, that western portion, which their father obtained by settlement and purchase. The next day, Mar. 19, John Browne sold to his brother Jonathan, the same property for the same sum, subject to a mortgage of £220, to Jonathan Nutting, of Wrentham. After this mortgage was paid off (as it was done), the ancient homestead was again vested in the Browne family.

Jonathan Browne (eldest son of Capt. Abraham), in the lifetime of his father, lived in the ancient mansion, bequeathed to him by the Will of his father, situated on the N. side of Sudbury Road, nearly opposite to the house of his father. There is little doubt but that he lived in that house, until after the removal of his brother Samuel to Leicester, so that all his children were born in it; and it is very probable that it was his permanent residence. If he moved into the house, built and occupied by his father, he could have resided in it only a short time, as not long after the removal of his brother Samuel, who inherited and occupied the house, it was, by his son, Jonathan, Jr., mortgaged, Jan. 12, 1747, to Capt. Thomas Homans, who occupied it for a few years. This ancient house, on the N. side of Sudbury Road, without much doubt, was built and occupied by the first Nathan Fiske, of Watertown, on that lot in the Town Plot, which he bought of Robert Feake. From him it passed to his son, Serjt. John Fiske, who was living in it as late as 1703. How or when it came into the possession of Capt. Abraham Browne, has not been ascer-

tained. From Jonathan, Senior, it passed to Col. William Bond, who married his youngest daughter, and who also owned that part of the ancient Browne homestead, which was also bequeathed by Capt. Abraham to his son Jonathan. The western part of it, with the house built by Capt. Abraham B., was occupied by Jonathan, Jr., Esq., from whom it passed to his son, Major Adam Browne.

The 28 A. homestead of *Henry Goldstone* passed to his son-in-law, Dea. Henry Bright; then to his eldest son, Dea. John Bright, who died without issue, and it passed to his second son, Nathaniel Bright; then to his son, Cornet Henry Bright; then to his son-in-law, Isaac Sanderson; and Dec. 12, 1777, it was divided to his sons, Josiah and Henry Sanderson.

The 14 A. homestead, granted to *Thomas Bartlett*, and where he always resided, passed to his son-in-law, John Applin. Previous to Ap. 1683, Applin had sold to Henry Spring the eastern part, 6½ A. of it, and on June 8, 1697, Spring sold this to Jonas Bond. Ap. 3, 1683, Applin sold to John Dix the west part of it, then called 10 acres. Jan. 12, 1719-20, John Dix sold half an acre of this to Jonas Bond, Sen.; and July 5, 1732, John Dix, of Watertown, and Samuel Dix, of Worcester, sold the remainder of it, with mansion house, barn, and orchard, then called 8 A., to Jonas Bond, Jr., for £250, current money. This Bartlett lot, with other lands on the north, was the homestead of Jonas Bond, Jr., Esq. The dwelling-house stood where Mr. Cushing has built his farm-house. Sept. 8, 1695, Jonas Bond bought of William Bull and wife Elizabeth, 8 A. [the grant to Thomas Smith, which he sold to William Perry in 1651], "near the hill called and known by the name of Pigsgosuck, and is bounded east by Dea. Sanderson; west by the highway called Pigsgosuck highway [Common St.]; north by lands of Ellis Barron and John Chinery; south by land of Joseph Hastings." This land of Joseph Hastings, was the Benjamin Crispe lot. June 17, 1717, Jonas Bond, Sen., bought of Timothy Barron and wife Rachel, 12 A. adjoining the last purchase, and situated partly on the W. side of Common Street. A short time before this, Barron had purchased this land, or a part of it, of his father, Ellis Barron.

The lot of Dea. *Thomas Hastings*, on the west side of School St., was always his residence. He added to it by purchase the lot of H. Bright, Sen. This homestead, then 20 A., passed to his youngest son, Samuel. Mar. 15, 1727-8, his son Daniel (? David) for £300, bills of credit, sold ¾ of it to a committee of the town, for a ministerial lot, for the accommodation of Rev. S. Storer. The next month (Ap. 1), Joseph Coolidge, of Cambridge, guardian of Nathaniel, the youngest son of Samuel, sold the other ¾ of it to said committee. Oct. 18, 1755, a committee of the town sold this lot to Samuel Mason, housewright, of Newton, for £288, lawful money. This was the next year after building the meeting-house, at the junction of Bowman's Lane and Belmont St. The town bought the lot (¾ A.), for this meeting-house, of Nathaniel Harris, Esq., Jan. 29, 1754.

John Fiske bought the W. end (6 A.) of the Henry Dow lot, next south of Dea. T. Hastings, and this was his first homestead, which he sold, Mar. 15, 1648-9, to *Charles Stearns*.

Oct. 18, 1755, a committee of the town sold to Ebenezer Stone, "1½ A., formerly used as a training-field, bounded N. W. by Stone (the purchaser); S. by road [Belmont St.]; W. by David Coolidge; E. by lane [Grove St.], leading to Mrs. John Coolidge's house." It was on the training-place that the Fairs were ordered to be held, in 1639.

The lands of *Elder Edward How* [see map], obtained by repeated grants and purchase, passed to his son-in-law Nathaniel Treadway. Nov. 14, 1688, N. Treadway, for £140, sold this land (70 A.) and house, to his son Josiah. Oct. 13, 1699, Josiah Treadway and wife Dorothy, then of Charlestown, for £120, sold the western half of this land (35 A.) to Samuel Parris. Mar. 3, 1703, Parris sold it to Nathaniel Hobart, of Hingham. Hobart sold it to Daniel Stowall, who conveyed it back to Hobart, Feb. 6, 1707-8, and on the 12 Jan. 1709-10, Hobart sold it to Robert

Goddard for £230, then called 34 acres. It was then bounded S. by highway [Main St.]; E. by Caleb Church and Josiah Treadway; W. by Samuel Eddy, Elizabeth Woodward [wid. of George], Caleb Church, and Benjamin Wellington; N. by B. W. and S. Eddy. The other part of the How estate (27 or 30 A.) passed from Josiah to his son, James Treadway, who, on Jan. 9, 1710-11, sold it to John Coolidge, housewright. It was bounded S. by County Road (Main St.); W. by C. Church and R. Goddard; N. by R. Goddard and S. Eddy; E. by County Road (Mount Auburn St.), and Samuel Eddy. It will be observed that this was not the whole of the east half. About 6 A. had been sold to Caleb Church, probably soon after the purchase by Josiah Treadway. Church was licensed to keep a tavern in 1686. Ap. 25, 1712, C. Church, millwright, sold this land (6 A.) to Thomas Learned, where he and his family kept a tavern fifty years or more. The Spring Hotel has been built on that lot.

The 2 A. lot, bounded S. by the river, N. by Mill Creek, and extending from the bridge to the dam, was a grant to E. How. This grant, in addition to what is said in § 140, is an additional reason for believing that he built the mill. [See p. 747.]

In 1635, 20 A. was laid out "to the use of the mill:" it was not a grant in fee to the owner of the mill. The town still held it, and had the right to dispose of it, and for this reason Mr. Dudley is not named among the proprietors. In 1677, the town sold a small part of it to Caleb Church, which was about the date of his settlement in Watertown. July 7, 1752, a committee of the town sold the eastern point of this land (16 rods) to Nathaniel Harris, Esq.

The 150 acres granted "to the use of the wear," was by the Court confirmed to Mr. Mayhew in 1641 [§§ 131-4], but it was not included in the list of his possessions, and it has not been ascertained when or by whom it first began to be occupied and improved.

The records do not show who was the original grantee of the 20 A. homestall of *John Flemming*. His heirs sold this and other lands to Rev. Roger Nevinson. Mar. 4, 1677-8, John Nevinson, son and att'y of Roger Nevinson, for £160, sold to Nathaniel Bright this homestall (house and 20 A.); also two lots of dividend land, of 15 A. and 50 A. Ap. 2, 1651, Flemming bought of Thomas Andrews, of Camb., the lot at the N. E. corner of Lexington and Belmont St., which was a grant to Edmund James; but probably it was sold before the decease of Flemming to John Bisco. Flemming also bought land on the south side of Belmont St., nearly opposite to his homestall, which his wid. and ex'ors sold to his son-in-law, John Barnard.

It is probable that *William Hammond* settled at first on Cambridge Road, very near the Cambridge line [see map]. Whether this was a grant to him, the records do not show. He sold it early and settled on his 40 A. homestall, situated east of Pequusset meadow. He also owned three small lots in Pequusset meadow, one of them granted to him, and the other two purchased. This homestall passed to his son Thomas. The Inventory of the estate of T. H. by John Livermore and Ens. John Sherman, showed that it did not equal the amount of his debts, and the estate was assigned to John Livermore and Steadman.

On the 29th Sept., 1663, Edmund Sherman, clothworker, of Dedham, Eng. (formerly of Watertown), by his attorney, Rev. John Sherman, his brother, brought a suit against the assignees for "two broadcloths," adventured and sent over to Thomas Hammond. Verdict for the plaintiff, £40. It appears by the will of Dea. Henry Bright, p. 105, that this homestall, with the adjoining meadows, was put into the possession of Rev. John Sherman, who sold them to Dea. H. Bright.

John Warren first settled on a lot on Water Street; but he sold it, and moved early to a lot on the east side of Lexington Street, next to that of Isaac Sterne, where he resided permanently. The N. E. corner of Belmont and Lexington Streets formerly was called Commodore's Corner, and it is said to have been so named for Samuel Warren, who lived there, and was called The Commodore.

Isaac Sterne settled first upon his homestall on Cambridge Road, near Cambridge Line. But he moved early to a larger homestall on the east side of Lexington St., immediately south of that of John Warren, where he resided permanently. It passed to his son Samuel, then to his grandson, Nathaniel. *John Firmin* settled first, as it is believed, on Water Street, but removed early to his land on Bank Lane, a little distance east of Dorchester Field.

The locality of the homestalls of *Abraham Shaw* and *William Bridges* imply that they were first settlers, but they sold and moved away so early that the schedules do not show whether they were granted or purchased.

The grant of a homestall to *John Lawrence*, east of the Fresh Pond, and adjoining that of Robert Seeley, implies that he was a first settler; but he settled very early on a lot granted to him on the west side of Common Street, which was his permanent residence, until he moved to Groton, except, perhaps, a temporary residence in Boston.

In 1643, *Capt. John Sherman* owned two homestalls, both obtained by purchase. The arrangement of lots, in the list of his possessions, implies that he occupied the lot on Bank Lane, which had been granted to Thomas Rogers. But it is more probable that he settled at first on his homestall on the east side of Common Street, immediately south of Strawberry Hill. This was his permanent residence, and it passed to his son Joseph. In 1643 it consisted of the two lots granted Daniel Morse and Edmund James, and, by estimation, contained 16½ acres. It was afterwards enlarged by purchasing adjoining lands, and, in the time of his son Joseph, embraced the lots granted to John Reynolds and I. Mixer. He had few grants, and most of his early possessions were grants made to Thomas Rogers.

The residence of *Rev. John Sherman* was the Richard Holden lot on the N. side of Belmont Street. He next purchased the Stebbin lot, on the east, as already stated. In 1673, Justinian Holden, then of Cambridge, "sold to John Sherman, Pastor, two parcels of land adjoining or adjacent to the dwelling-house of Mr. Sherman." His land, after this purchase, nearly surrounded the Pond at the N. E. corner of Belmont and Grove Streets. The town had granted Mr. Sherman the use of 20 A. on Meeting-house Common for firing.

Concerning the residence of *Thurston Raynor*, *Gregory Stone*, *Thomas Boylston*, and *John Chinery*, see those names in the Catalogue, pp. 1005, &c.

The lot of *Christopher Grant*, on the N. side of Belmont Street, is called a grant of 5 A. in the schedule of grants; but in the sale of it to G. Church, with one acre of Pond, it is stated that 3 A. were granted to himself, 3 A. to L. Waters, and the 1 A. of Pond granted to John Griggs. At this sale it was bounded W. by Mr. Sherman. The lot of *O. Callow*, on the W. side of School Street, passed to *Wm. Williams*, then to his widow, then to her son, *Abraham Williams*, who sold it to R. Wellington. The *Godfrey* lot was granted to Hugh Mason, who probably sold it to Godfrey at the time he [M.] purchased his large homestall on the E. side of School Street. Oct. 17, 1653, *William Godfrey* sold his homestall to Robert Sanderson [see p. 257]. A part (6 A.) of the 16 A. Parkhurst lot was purchased by H. Mason. This 6 A. was a grant to E. James. The 21 A. homestall of *Capt. H. Mason* was his permanent residence, and he purchased a part of the H. Dow lot (? or R. Veazy lot), on the other side of the street. It passed to his son Joseph; then to his grandson, Dea. Joseph, Jr., Esq.; then probably to his gr. grandson, Nehemiah. The *Ellis Barron* lot (which was a grant to Richard Kembal) was the residence of that family, so long as they remained in town. Ellis Barron, Jr., sold it, or a part of it, in 1707, to his son Timothy, who sold it, in 1717, to Jonas Bond. The adjoining 8 A. homestall lot of *Thomas Smith* was bought by Wm. Perry about the time Smith moved within the present limits of Waltham. [See Jonas Bond above.]

The 7 A. lot of *Benjamin Crispe* was his residence, until he moved to Groton, soon after which he sold it to Thomas Boyden, about which time he (B.) returned to Watertown. The 4½ A. lot, at the S. E. corner of Belmont and School Streets,

1650-1, Cutler sold his share (100 A.) to Bowman for £39. It is probable that Cutler and Bowman moved from Watertown about this date. [See pp. 88 and 189.]

The 5 A. lot at the S. E. corner of Belmont St. and Bowman's Lane was the residence of *John Bisco*, in 1643. The 6 A. homestall lot of *Benjamin Bullard*, near the N. W. point of Fresh Pond, probably belonged to his father, *Robert Bullard*, whose wid., *Anna, m. N. Theale*. The 6 A. homestall, where *N. Theale* resided in 1644, in Bowman's Field, had probably belonged to R. Bullard. *John Coolidge* settled first on the Camb. line a little W. of Fresh Pond, and probably always resided there. *Richard Kimball's* residence was at the E. of Fresh Pond. That of *Henry Kimball, Sen.*, was on his lot adjoining that of N. Bowman. *Joseph Morse* settled first on the S. side, of Orchard St., and in 1640 exchanged it for the 18 A. lot, E. side of Pequusset Common.

The preceding explanations apply exclusively to what were called the Small Lots [§ 81], and they illustrate, in part, what was said in § 84 and § 85, about the multitude of lots and the frequent change of ownership. In further illustration of the multiplicity of lots, we would refer to the lots in the Great Dividends, in the Beaver Brook plowlands, the lieu of township lots, the lots in the West Pine and other meadows, and the Farms. [See pp. 1021-23.]

The changes of ownership were in many instances wholesale. All the lots granted to Gregory Stone, and his purchased homestall, were purchased for Thomas Boylston. The 7 lots granted to John Bachelor, and the 6 lots granted to Robert Tucke, were all purchased by Jeremiah Norcross. These were not all of N.'s purchases. All the lots of Peter Noyea were purchased of Bryan Pendleton. The numerous lots granted to Thomas Cakebread passed to *John Grout*. The numerous lots of Nicholas Knapp and of Robert Lockwood, were bought by B. Pendleton, after he returned from Sudbury, and by him they were sold to Robert Daniel. After his decease, they passed to his son Samuel Daniel, who sold to his brother-in-law, Thomas Fanning, what had been the homestalls of his father, of Robert Lockwood, and of Nicholas Knapp. All the lots held by Thomas Andrews, were grants to Edmund James. All the lots which Thomas Philbrick retained until his removal to Hampton, were purchased by Isaac Sterne. John Ellet sold his house and 5 lots to Thomas Wincoll. Edward Lamb sold most of the lots granted to him, to Charles Stearns. Most of the lands granted to John Simson passed to George Parkhurst, who married his widow. All the lots of John Firmin (with the exception of his first homestall in "the town," sold to Henry Bright, Jr., and his lot in the Town Plot, sold to Joseph Bemis), were by his heirs sold to Barnabas Farr, of Boston, and by Farr sold to Richard Beers. The 2 lots granted to Nathaniel Foote, were bought by Henry Cuttris, and by him sold to Jeremiah Norcross. The 4 lots granted to Robert Abbot, were sold to Roger Wellington. John Stowers sold to Thomas Hammond, at one time, a dwelling and 18 lots of land. He had previously sold some lots, and he still held a 130 A. farm. In addition to the lots granted to John Woolcot and his widow, he purchased the 5 lots of Philip Tabor, some, if not all, of the lots of Abraham Shaw, and one or more lots granted to John Tucker; and from his widow, Winifred, most of them passed to Edmund White, of London, and by David Yale, his attorney, they were sold to Samuel Thatcher. 8 lots were granted to John Gosse, and all of them that he retained until his decease, were by his heirs sold to Samuel Stratton. John Knight, from Sudbury, owned 15 lots in 1643, all obtained by purchase or exchange, except one farm of 287 A., ten of which lots he sold to Thomas Underwood, at the time Underwood moved from Dorchester to Watertown. The 9 lots granted to Henry Goldstone, and the 4 lots purchased by him, all, so far as ascertained, passed to his son-in-law, Dea. Henry Bright.

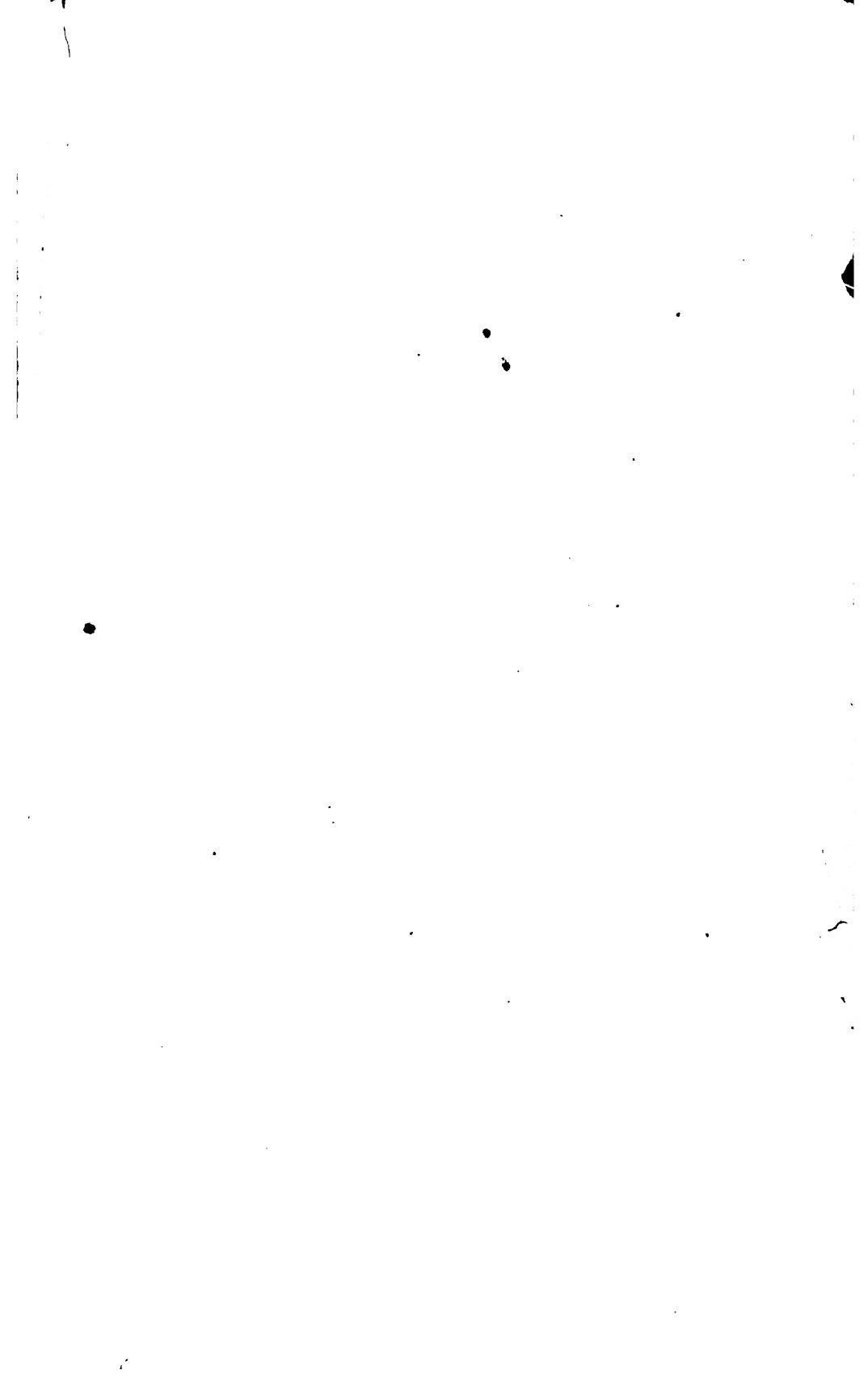

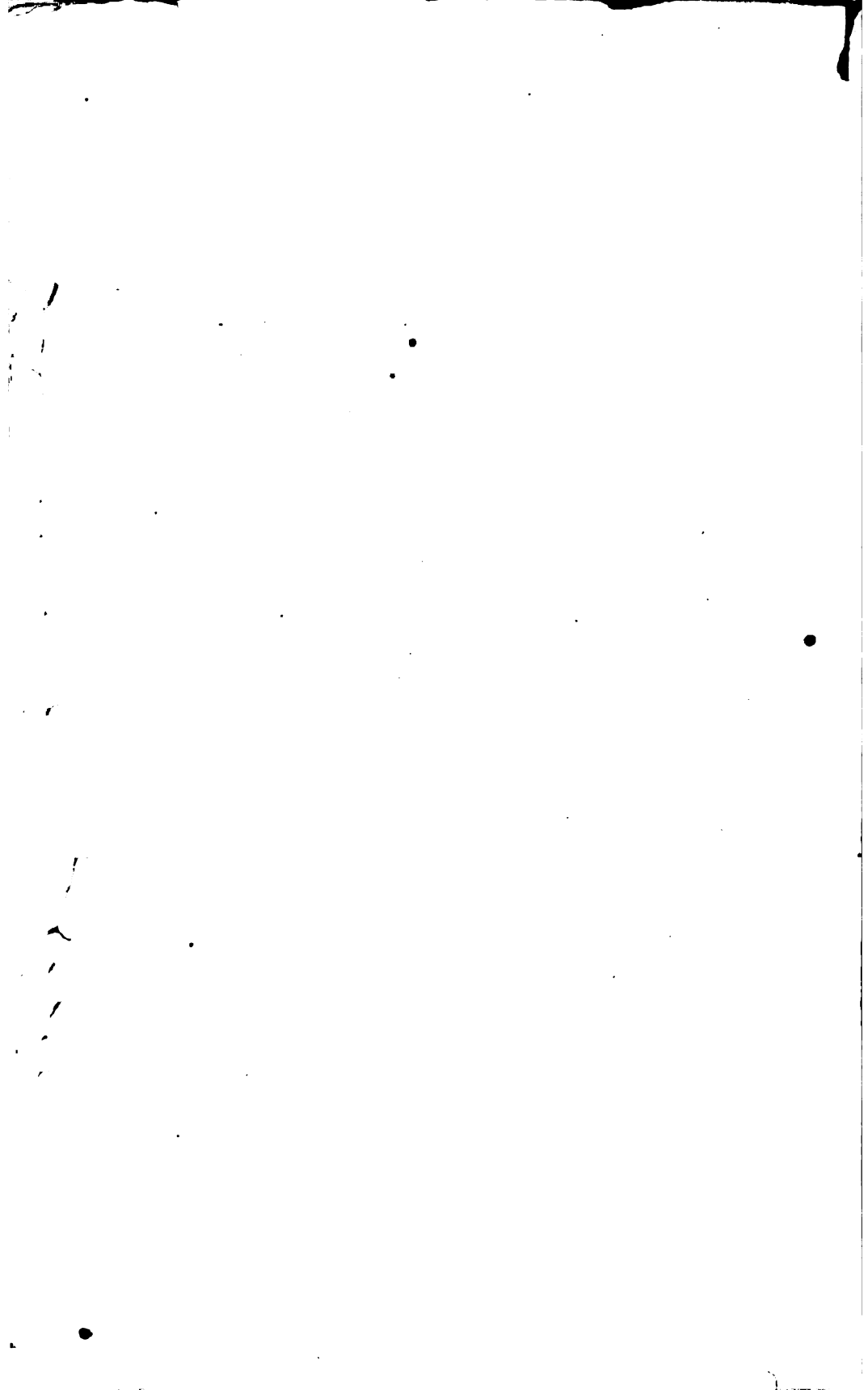

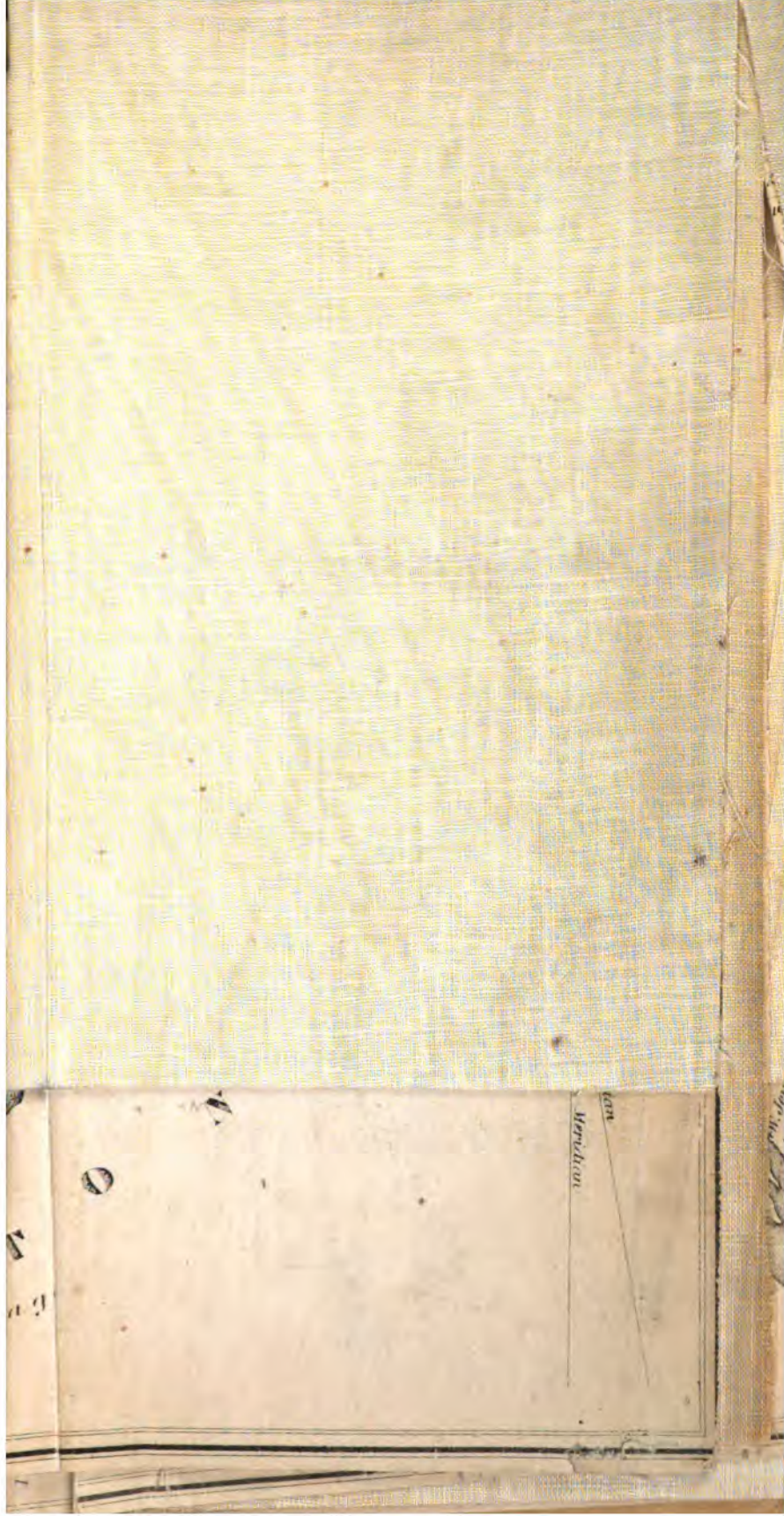

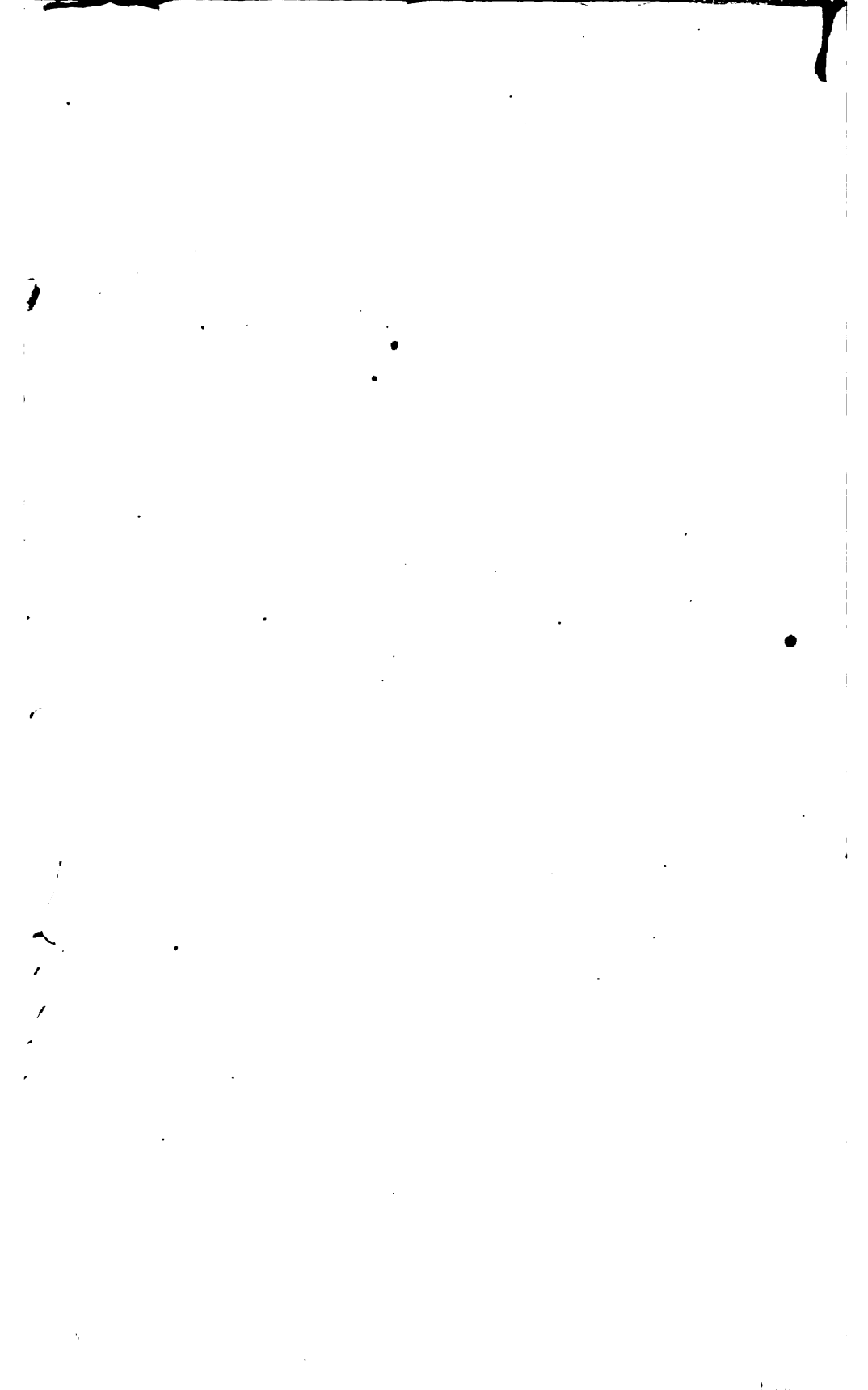

7 M 5480

10

1000
Herodotus

1934
1/2
1/2
1/2

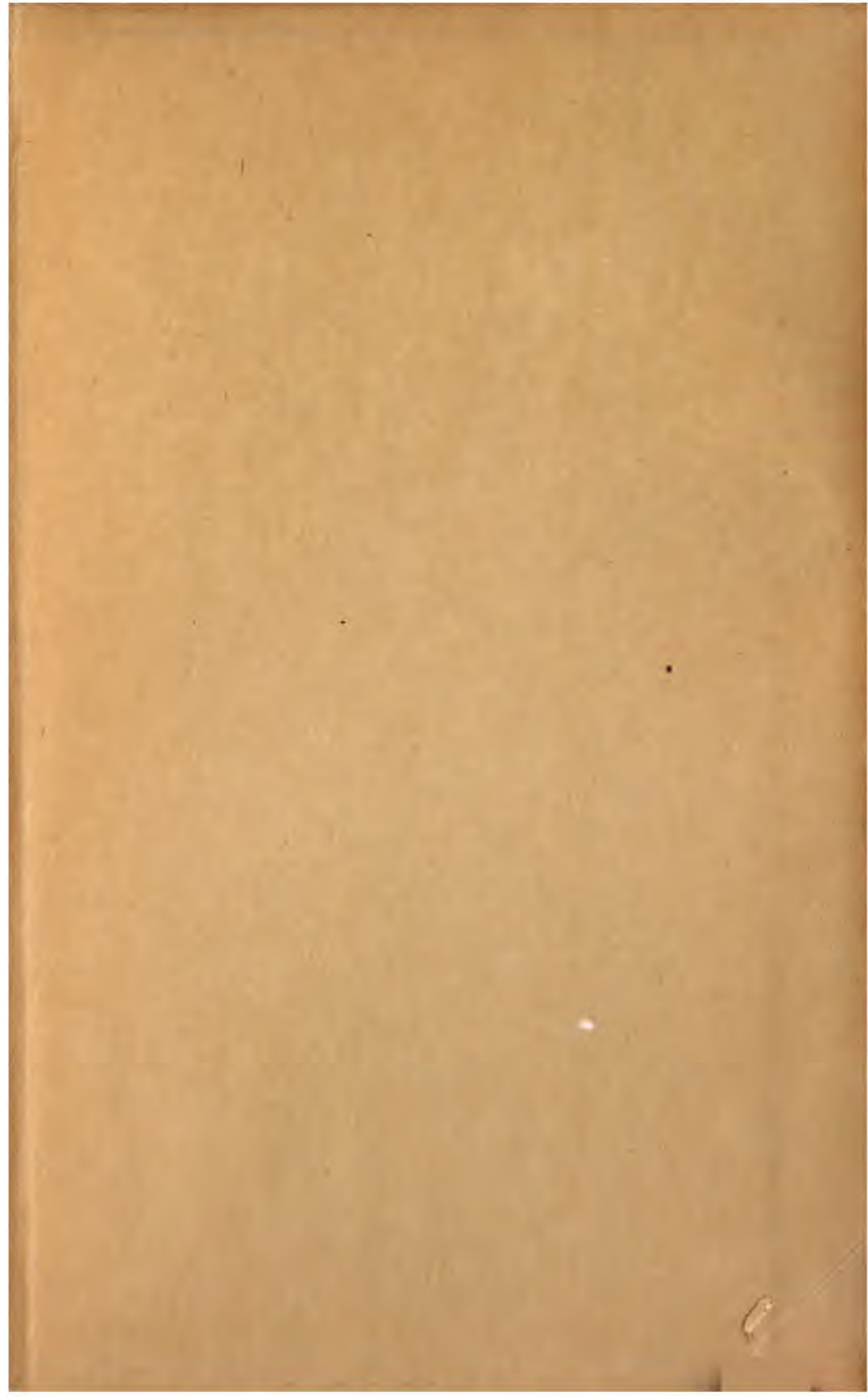

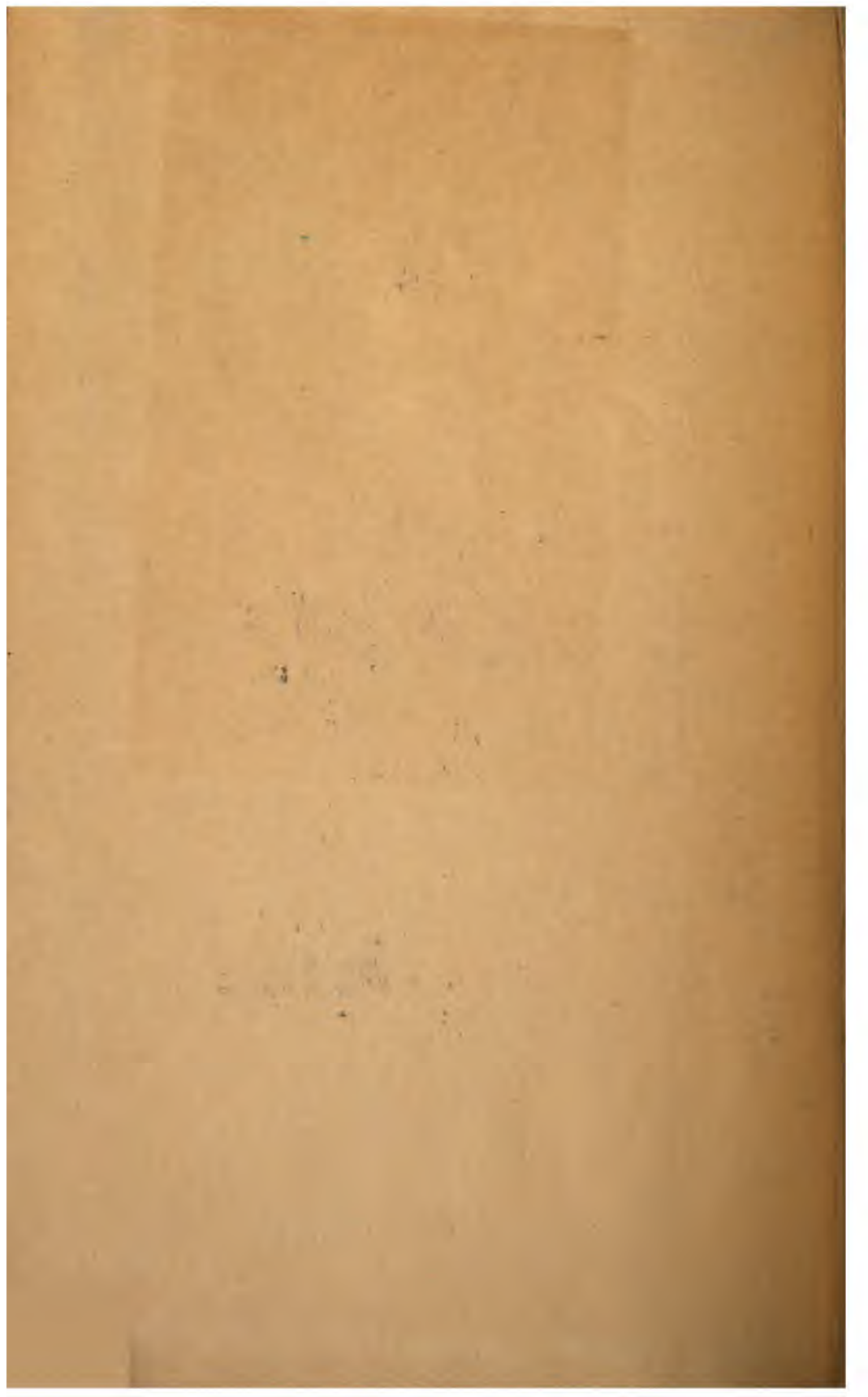



3 2044 012 643 938



1979



